

To our customers,

---

## Old Company Name in Catalogs and Other Documents

---

On April 1<sup>st</sup>, 2010, NEC Electronics Corporation merged with Renesas Technology Corporation, and Renesas Electronics Corporation took over all the business of both companies. Therefore, although the old company name remains in this document, it is a valid Renesas Electronics document. We appreciate your understanding.

Renesas Electronics website: <http://www.renesas.com>

April 1<sup>st</sup>, 2010  
Renesas Electronics Corporation

Issued by: Renesas Electronics Corporation (<http://www.renesas.com>)

Send any inquiries to <http://www.renesas.com/inquiry>.

## Notice

1. All information included in this document is current as of the date this document is issued. Such information, however, is subject to change without any prior notice. Before purchasing or using any Renesas Electronics products listed herein, please confirm the latest product information with a Renesas Electronics sales office. Also, please pay regular and careful attention to additional and different information to be disclosed by Renesas Electronics such as that disclosed through our website.
2. Renesas Electronics does not assume any liability for infringement of patents, copyrights, or other intellectual property rights of third parties by or arising from the use of Renesas Electronics products or technical information described in this document. No license, express, implied or otherwise, is granted hereby under any patents, copyrights or other intellectual property rights of Renesas Electronics or others.
3. You should not alter, modify, copy, or otherwise misappropriate any Renesas Electronics product, whether in whole or in part.
4. Descriptions of circuits, software and other related information in this document are provided only to illustrate the operation of semiconductor products and application examples. You are fully responsible for the incorporation of these circuits, software, and information in the design of your equipment. Renesas Electronics assumes no responsibility for any losses incurred by you or third parties arising from the use of these circuits, software, or information.
5. When exporting the products or technology described in this document, you should comply with the applicable export control laws and regulations and follow the procedures required by such laws and regulations. You should not use Renesas Electronics products or the technology described in this document for any purpose relating to military applications or use by the military, including but not limited to the development of weapons of mass destruction. Renesas Electronics products and technology may not be used for or incorporated into any products or systems whose manufacture, use, or sale is prohibited under any applicable domestic or foreign laws or regulations.
6. Renesas Electronics has used reasonable care in preparing the information included in this document, but Renesas Electronics does not warrant that such information is error free. Renesas Electronics assumes no liability whatsoever for any damages incurred by you resulting from errors in or omissions from the information included herein.
7. Renesas Electronics products are classified according to the following three quality grades: “Standard”, “High Quality”, and “Specific”. The recommended applications for each Renesas Electronics product depends on the product’s quality grade, as indicated below. You must check the quality grade of each Renesas Electronics product before using it in a particular application. You may not use any Renesas Electronics product for any application categorized as “Specific” without the prior written consent of Renesas Electronics. Further, you may not use any Renesas Electronics product for any application for which it is not intended without the prior written consent of Renesas Electronics. Renesas Electronics shall not be in any way liable for any damages or losses incurred by you or third parties arising from the use of any Renesas Electronics product for an application categorized as “Specific” or for which the product is not intended where you have failed to obtain the prior written consent of Renesas Electronics. The quality grade of each Renesas Electronics product is “Standard” unless otherwise expressly specified in a Renesas Electronics data sheets or data books, etc.
  - “Standard”: Computers; office equipment; communications equipment; test and measurement equipment; audio and visual equipment; home electronic appliances; machine tools; personal electronic equipment; and industrial robots.
  - “High Quality”: Transportation equipment (automobiles, trains, ships, etc.); traffic control systems; anti-disaster systems; anti-crime systems; safety equipment; and medical equipment not specifically designed for life support.
  - “Specific”: Aircraft; aerospace equipment; submersible repeaters; nuclear reactor control systems; medical equipment or systems for life support (e.g. artificial life support devices or systems), surgical implantations, or healthcare intervention (e.g. excision, etc.), and any other applications or purposes that pose a direct threat to human life.
8. You should use the Renesas Electronics products described in this document within the range specified by Renesas Electronics, especially with respect to the maximum rating, operating supply voltage range, movement power voltage range, heat radiation characteristics, installation and other product characteristics. Renesas Electronics shall have no liability for malfunctions or damages arising out of the use of Renesas Electronics products beyond such specified ranges.
9. Although Renesas Electronics endeavors to improve the quality and reliability of its products, semiconductor products have specific characteristics such as the occurrence of failure at a certain rate and malfunctions under certain use conditions. Further, Renesas Electronics products are not subject to radiation resistance design. Please be sure to implement safety measures to guard them against the possibility of physical injury, and injury or damage caused by fire in the event of the failure of a Renesas Electronics product, such as safety design for hardware and software including but not limited to redundancy, fire control and malfunction prevention, appropriate treatment for aging degradation or any other appropriate measures. Because the evaluation of microcomputer software alone is very difficult, please evaluate the safety of the final products or system manufactured by you.
10. Please contact a Renesas Electronics sales office for details as to environmental matters such as the environmental compatibility of each Renesas Electronics product. Please use Renesas Electronics products in compliance with all applicable laws and regulations that regulate the inclusion or use of controlled substances, including without limitation, the EU RoHS Directive. Renesas Electronics assumes no liability for damages or losses occurring as a result of your noncompliance with applicable laws and regulations.
11. This document may not be reproduced or duplicated, in any form, in whole or in part, without prior written consent of Renesas Electronics.
12. Please contact a Renesas Electronics sales office if you have any questions regarding the information contained in this document or Renesas Electronics products, or if you have any other inquiries.

(Note 1) “Renesas Electronics” as used in this document means Renesas Electronics Corporation and also includes its majority-owned subsidiaries.

(Note 2) “Renesas Electronics product(s)” means any product developed or manufactured by or for Renesas Electronics.

**SILICON MMIC LOW CURRENT AMPLIFIERS  
FOR CELLULAR/CORDLESS TELEPHONES**
**DESCRIPTION**

The  $\mu$ PC8128TB,  $\mu$ PC8151TB and  $\mu$ PC8152TB are silicon monolithic integrated circuits designed as buffer amplifiers for cellular or cordless telephones. These amplifiers can realize low current consumption with external chip inductor (eg 1005 size) which can not be realized on internal 50  $\Omega$  wideband matched IC. These low current amplifiers operate on 3.0 V.

These ICs are manufactured using NEC's 20 GHz fr NESAT™ III silicon bipolar process. This process uses silicon nitride passivation film and gold electrodes. These materials can protect chip surface from external pollution and prevent corrosion/migration. Thus, these ICs have excellent performance, uniformity and reliability.

**FEATURES**

- Supply voltage :  $V_{CC} = 2.4$  to  $3.3$  V
- Low current consumption :  $\mu$ PC8128TB ;  $I_{CC} = 2.8$  mA TYP. @ $V_{CC} = 3.0$  V  
 $\mu$ PC8151TB ;  $I_{CC} = 4.2$  mA TYP. @ $V_{CC} = 3.0$  V  
 $\mu$ PC8152TB ;  $I_{CC} = 5.6$  mA TYP. @ $V_{CC} = 3.0$  V
- High efficiency :  $\mu$ PC8128TB ;  $P_{O(1\text{ dB})} = -4.0$  dBm TYP. @ $f = 1$  GHz  
 $\mu$ PC8151TB ;  $P_{O(1\text{ dB})} = +2.5$  dBm TYP. @ $f = 1$  GHz  
 $\mu$ PC8152TB ;  $P_{O(1\text{ dB})} = -4.5$  dBm TYP. @ $f = 1$  GHz
- Power gain :  $\mu$ PC8128TB, 8151TB ;  $G_P = 12.5$  dB TYP. @ $f = 1$  GHz  
 $\mu$ PC8152TB ;  $G_P = 23$  dB TYP. @ $f = 1$  GHz
- Excellent isolation :  $\mu$ PC8128TB ; ISL = 39 dB TYP. @ $f = 1$  GHz  
 $\mu$ PC8151TB ; ISL = 38 dB TYP. @ $f = 1$  GHz  
 $\mu$ PC8152TB ; ISL = 40 dB TYP. @ $f = 1$  GHz
- Operating frequency : 100 to 1 900 MHz (Output port LC matching)
- High-density surface mounting : 6-pin super minimold package ( $2.0 \times 1.25 \times 0.9$  mm)
- Light weight : 7 mg (Standard value)

**APPLICATION**

- Buffer Amplifiers on 800 to 1 900 MHz cellular or cordless telephones

**Caution Electro-static sensitive devices**

The information in this document is subject to change without notice. Before using this document, please confirm that this is the latest version.  
 Not all devices/types available in every country. Please check with local NEC representative for availability and additional information.

**ORDERING INFORMATION**

Part Number	Package	Marking	Supplying Form
$\mu$ PC8128TB-E3	6-pin super minimold	C2P	<ul style="list-style-type: none"> <li>• Embossed tape 8 mm wide</li> <li>• 1, 2, 3 pins face the perforation side of the tape</li> <li>• Qty 3 kpcs/reel</li> </ul>
$\mu$ PC8151TB-E3		C2U	
$\mu$ PC8152TB-E3		C2V	

**Remark** To order evaluation samples, please contact your local NEC sales office.  
 Part number for sample order:  $\mu$ PC8128TB,  $\mu$ PC8151TB,  $\mu$ PC8152TB

**PIN CONNECTIONS**

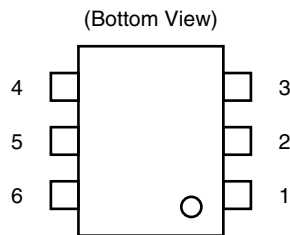
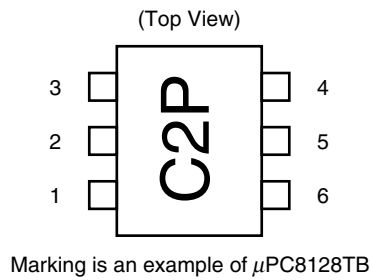

Pin No.	Pin Name
1	INPUT
2	GND
3	GND
4	OUTPUT
5	GND
6	V <sub>CC</sub>

★ **PRODUCT LINE-UP** ( $T_A = +25^\circ\text{C}$ ,  $V_{CC} = V_{out} = 3.0\text{ V}$ ,  $Z_s = Z_L = 50\ \Omega$ )

Parameter Part No.	$I_{CC}$ (mA)	1.0 GHz output port matching frequency			1.66 GHz output port matching frequency			1.9 GHz output port matching frequency			2.4 GHz output port matching frequency			Marking
		GP (dB)	ISL (dB)	$P_{O(1\text{ dB})}$ (dBm)	GP (dB)	ISL (dB)	$P_{O(1\text{ dB})}$ (dBm)	GP (dB)	ISL (dB)	$P_{O(1\text{ dB})}$ (dBm)	GP (dB)	ISL (dB)	$P_{O(1\text{ dB})}$ (dBm)	
$\mu$ PC8128TB	2.8	12.5	39	-4.0	13	39	-4.0	13	37	-4.0	-	-	-	C2P
$\mu$ PC8151TB	4.2	12.5	38	+2.5	15	36	+1.5	15	34	+0.5	-	-	-	C2U
$\mu$ PC8152TB	5.6	23	40	-4.5	19.5	38	-8.5	17.5	35	-8.5	-	-	-	C2V
$\mu$ PC8178TB	1.9	11	39	-4.0	-	-	-	11.5	40	-7.0	11.5	38	-7.5	C3B
$\mu$ PC8179TB	4.0	13.5	44	+3.0	-	-	-	15.5	42	+1.5	15.5	41	+1.0	C3C

**Remarks** Typical performance. Please refer to ELECTRICAL CHARACTERISTICS in detail.

**SYSTEM APPLICATION EXAMPLE**

**EXAMPLE OF DIGITAL CELLULAR TELEPHONE**

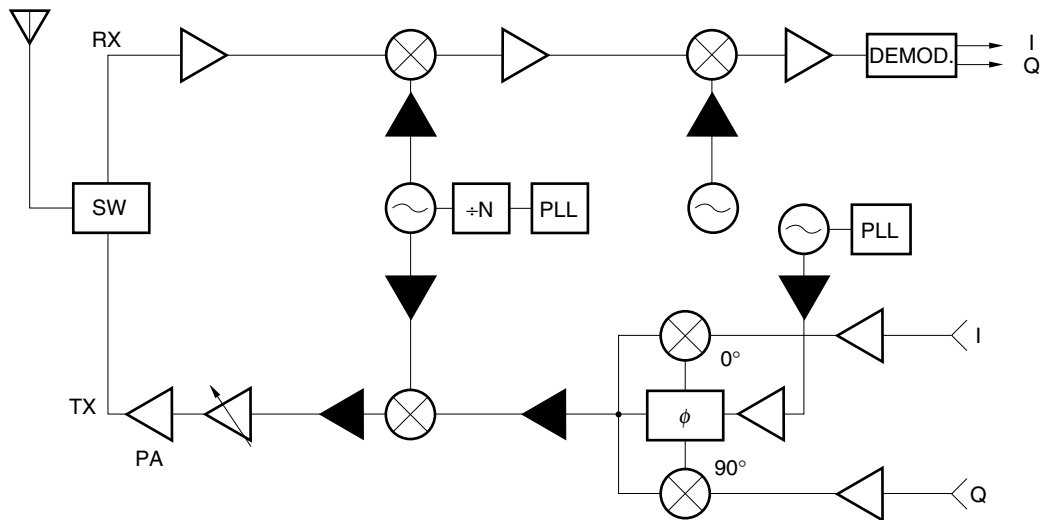

These ICs can be added to your system around ▲ parts, when you need more isolation or gain. The application herein, however, shows only examples, therefore the application can depend on your kit evaluation.

**PIN EXPLANATION**

Pin No.	Pin Name	Applied Voltage (V)	Pin Voltage (V) <sup>Note</sup>	Function and Applications	Internal Equivalent Circuit
1	INPUT	–	0.90 1.06 0.80	Signal input pin. A internal matching circuit, configured with resistors, enables 50 $\Omega$ connection over a wide band. This pin must be coupled to signal source with capacitor for DC cut.	<p><math>\mu</math>PC8128TB, <math>\mu</math>PC8151TB</p>
2 3 5	GND	0	–	Ground pin. This pin should be connected to system ground with minimum inductance. Ground pattern on the board should be formed as wide as possible. All the ground pins must be connected together with wide ground pattern to decrease impedance difference.	
4	OUTPUT	voltage as same as $V_{cc}$ through external inductor	–	Signal output pin. This pin is designed as collector output. Due to the high impedance output, this pin should be externally equipped with LC matching circuit to next stage. For L, a size 1005 chip in-ductor can be chosen.	<p><math>\mu</math>PC8152TB</p>
6	$V_{cc}$	2.4 to 3.3	–	Power supply pin. This pin should be externally equipped with bypass capacitor to minimize its inpedance.	

**Note** Pin voltage is measured at  $V_{cc} = 3.0$  V. Above:  $\mu$ PC8128TB, Center:  $\mu$ PC8151TB, Below:  $\mu$ PC8152TB

**ABSOLUTE MAXIMUM RATINGS**

Parameter	Symbol	Conditions	Ratings	Unit
Supply Voltage	V <sub>CC</sub>	T <sub>A</sub> = +25°C, Pin 4, Pin 6	3.6	V
Circuit Current	I <sub>CC</sub>	T <sub>A</sub> = +25°C	15	mA
Power Dissipation	P <sub>D</sub>	Mounted on double-sided copper clad 50 × 50 × 1.6 mm epoxy glass PWB, T <sub>A</sub> = +85°C	270	mW
Operating Ambient Temperature	T <sub>A</sub>		-40 to +85	°C
Storage Temperature	T <sub>stg</sub>		-55 to +150	°C
Input Power	P <sub>in</sub>	T <sub>A</sub> = +25 °C	+5	dBm

★

**RECOMMENDED OPERATING RANGE**

Parameter	Symbol	MIN.	TYP.	MAX.	Unit	Remark
Supply Voltage	V <sub>CC</sub>	2.4	3.0	3.3	V	The same voltage should be applied to pin 4 and pin 6.
Operating Frequency	f <sub>opt</sub>	0.1	–	1.9	GHz	Matched output port with external LC

**ELECTRICAL CHARACTERISTICS**

(Unless otherwise specified,  $T_A = +25^\circ\text{C}$ ,  $V_{CC} = V_{out} = 3.0\text{ V}$ ,  $Z_s = Z_L = 50\ \Omega$ , at LC matched frequency)

Parameter	Symbol	Conditions	$\mu$ PC8128TB			$\mu$ PC8151TB			$\mu$ PC8152TB			Unit
			MIN.	TYP.	MAX.	MIN.	TYP.	MAX.	MIN.	TYP.	MAX.	
Circuit Current	$I_{CC}$	No signal	1.8	2.8	3.8	2.8	4.2	5.8	4.2	5.6	7.1	mA
Power Gain	$G_P$	$f = 1.00\text{ GHz}$	9.5	12.5	14.5	9.5	12.5	14.5	20	23	25	dB
		$f = 1.66\text{ GHz}$	10	13	15	12	15	17	16.5	19.5	21.5	
		$f = 1.90\text{ GHz}$	10	13	15	12	15	17	14.5	17.5	19.5	
Isolation	ISL	$f = 1.00\text{ GHz}$	34	39	–	33	38	–	35	40	–	dB
		$f = 1.66\text{ GHz}$	34	39	–	31	36	–	32	36	–	
		$f = 1.90\text{ GHz}$	32	37	–	29	34	–	30	35	–	
Gain 1 dB Compression Output Power	$P_{O(1\text{ dB})}$	$f = 1.00\text{ GHz}$	–7.5	–4.0	–	–1.0	+2.5	–	–7.5	–4.5	–	dBm
		$f = 1.66\text{ GHz}$	–8.5	–4.0	–	–2.5	+1.5	–	–11.5	–8.5	–	
		$f = 1.90\text{ GHz}$	–8.5	–4.0	–	–3.0	+0.5	–	–11.5	–8.5	–	
Saturated Output Power <sup>Note</sup> ( $P_{in} = -6\text{ dBm}$ )	$P_{O(sat)}$	$f = 1.00\text{ GHz}$	–	–	–	–	–	–	–2.5	+0.5	–	dB
		$f = 1.66\text{ GHz}$	–	–	–	–	–	–	–5.5	–2.5	–	
		$f = 1.90\text{ GHz}$	–	–	–	–	–	–	–7.0	–3.0	–	
Noise Figure	NF	$f = 1.00\text{ GHz}$	–	6.0	7.5	–	6.0	7.5	–	3.5	5.0	dB
		$f = 1.66\text{ GHz}$	–	6.0	7.5	–	6.0	7.5	–	4.0	5.5	
		$f = 1.90\text{ GHz}$	–	6.0	7.5	–	6.0	7.5	–	4.5	6.0	
Input Return Loss (without matching circuit)	$RL_{in}$	$f = 1.00\text{ GHz}$	2	5	–	2	5	–	8.5	11.5	–	dB
		$f = 1.66\text{ GHz}$	2	5	–	1	4	–	7.5	10.5	–	
		$f = 1.90\text{ GHz}$	2.5	5.5	–	1	4	–	8.5	11.5	–	

**Note** Saturated output power is specified only in  $\mu$ PC8152TB which has flat saturated region.

**STANDARD CHARACTERISTICS**

(Unless otherwise specified,  $T_A = +25^\circ\text{C}$ ,  $V_{CC} = V_{out} = 3.0\text{ V}$ ,  $Z_s = Z_L = 50\ \Omega$ , at LC matched frequency)

Parameter	Symbol	Conditions	Reference Value			Unit
			$\mu$ PC8128TB	$\mu$ PC8151TB	$\mu$ PC8152TB	
Output Return Loss (with external matching circuit)	$RL_{out}$	$f = 1.00\text{ GHz}$	10	10	15	dB
		$f = 1.66\text{ GHz}$	25	18	7.5	
		$f = 1.90\text{ GHz}$	14	12	7	
3rd Order Intermodulation Distortion	$IM_3$	$f_1 = 1.000\text{ GHz}$ , $f_2 = 1.001\text{ GHz}$ , $P_{O(each)} = -20\text{ dBm}$	–50	–62	–51	dBc
		$f_1 = 1.660\text{ GHz}$ , $f_2 = 1.661\text{ GHz}$ , $P_{O(each)} = -20\text{ dBm}$	–46	–56	–43	
		$f_1 = 1.900\text{ GHz}$ , $f_2 = 1.901\text{ GHz}$ , $P_{O(each)} = -20\text{ dBm}$	–46	–54	–42	



TEST CIRCUIT

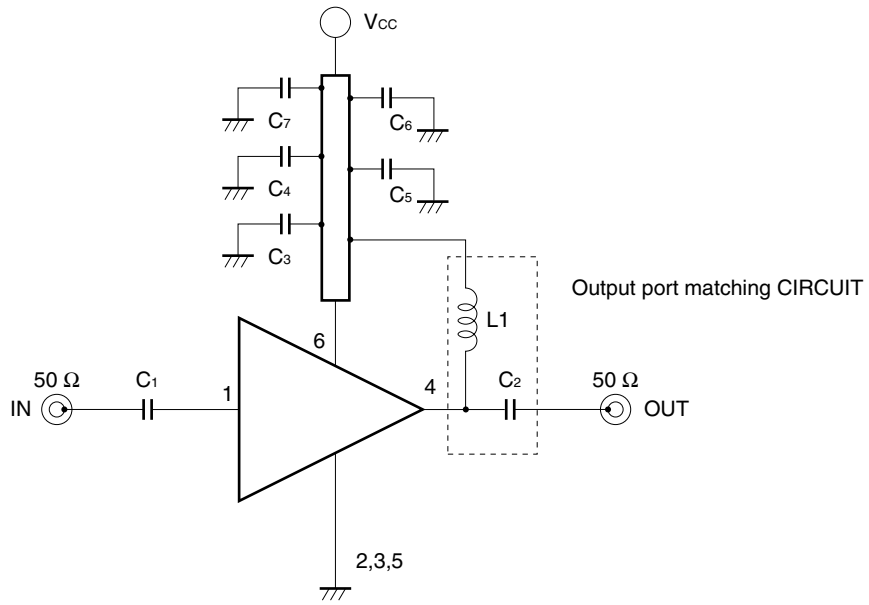
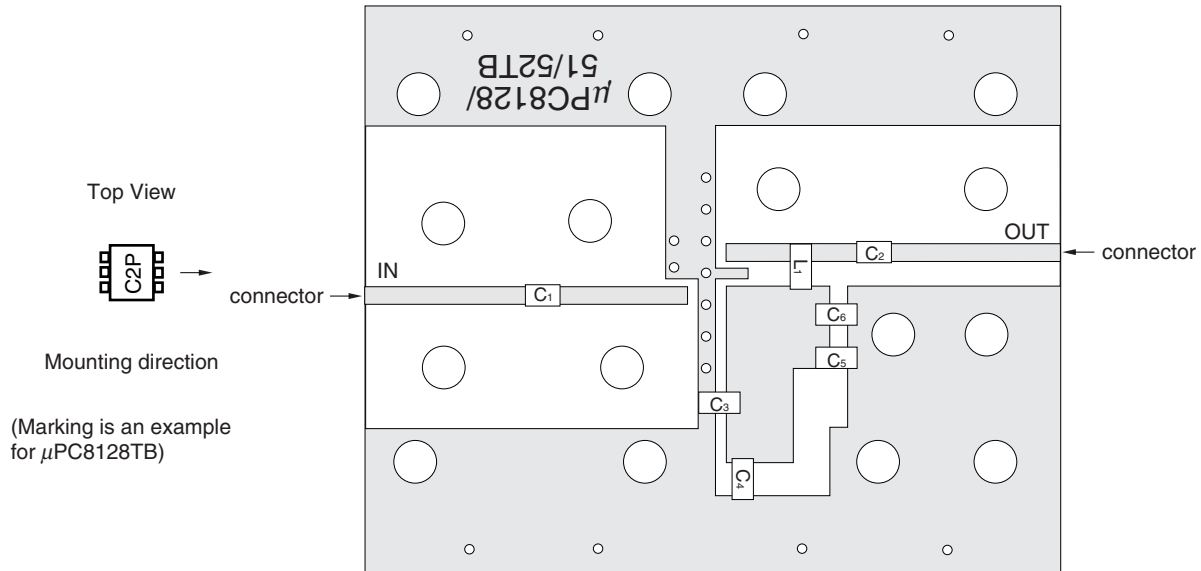

ILLUSTRATION OF THE TEST CIRCUIT ASSEMBLED ON EVALUATION BOARD

$\mu$ PC8128TB/ $\mu$ PC8151TB



COMPONENT LIST

	1.0 GHz output port matching	1.66 GHz output port matching	1.9 GHz output port matching
C <sub>1</sub> , C <sub>3</sub> to C <sub>6</sub>	1 000 pF	1 000 pF	1 000 pF
C <sub>2</sub>	1.0 pF	0.75 pF	0.75 pF
L <sub>1</sub>	8.2 nH	3.3 nH	2.2 nH

$\mu$ PC8152TB

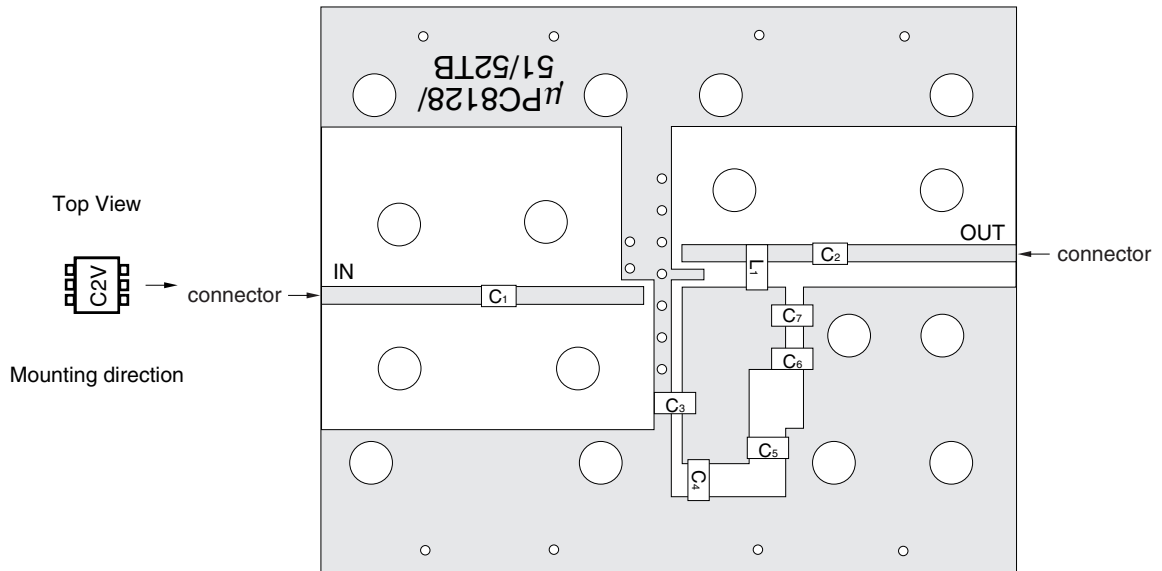

**COMPONENT LIST**

	1.0 GHz output port matching	1.66 GHz output port matching	1.9 GHz output port matching
C <sub>1</sub> , C <sub>3</sub> to C <sub>7</sub>	1 000 pF	1 000 pF	1 000 pF
C <sub>2</sub>	1.5 pF	1.0 pF	1.5 pF
L <sub>1</sub>	8.2 nH	1.8 nH	1.2 nH

**Notes**

1. 42 × 35 × 0.4 mm double-sided copper clad polyimide board.
2. Back side: GND pattern
3. Solder plated on pattern
4. ○ ○: Through holes

**EXAMPLE OF APPLICATION CIRCUIT ( $\mu$ PC8128TB,  $\mu$ PC8151TB)**

In improving  $RL_{in}$  of  $\mu$ PC8128TB and  $\mu$ PC8151TB at 1.0 GHz,  $L_2$  should be attached.

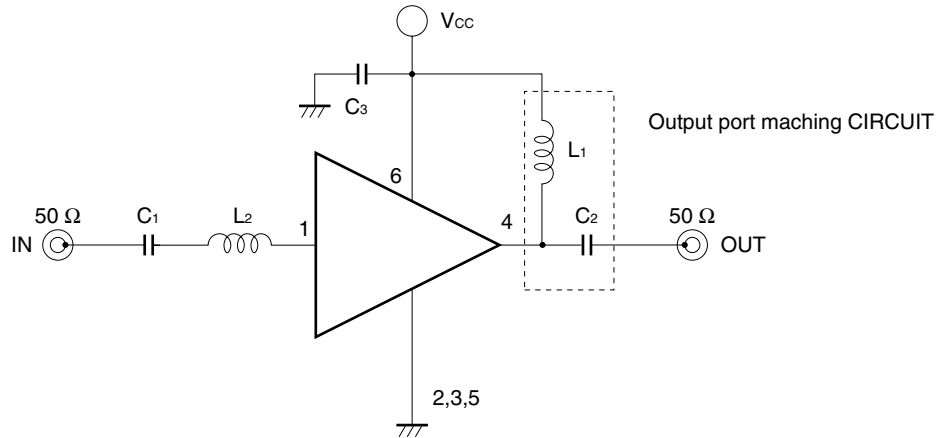

In improving  $RL_{in}$  of  $\mu$ PC8128TB and  $\mu$ PC8151TB at 1.66 GHz to 1.9 GHz,  $C'$  should be attached.

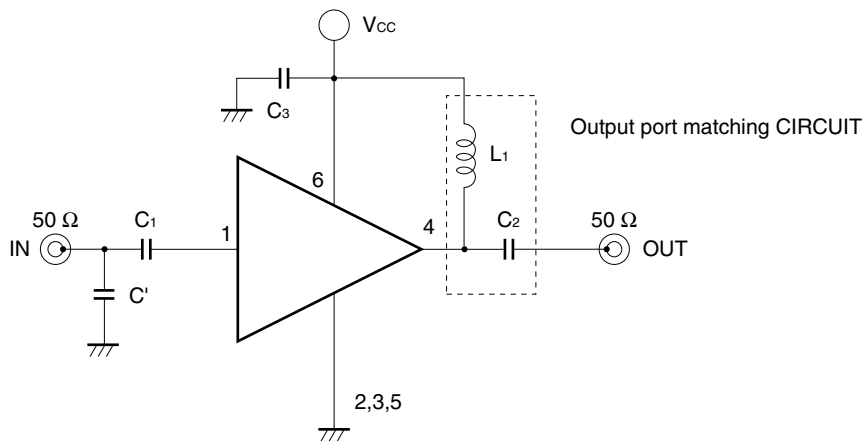

TYPICAL CHARACTERISTICS (Unless otherwise specified,  $T_A = +25^\circ\text{C}$ )

–  $\mu$ PC8128TB –

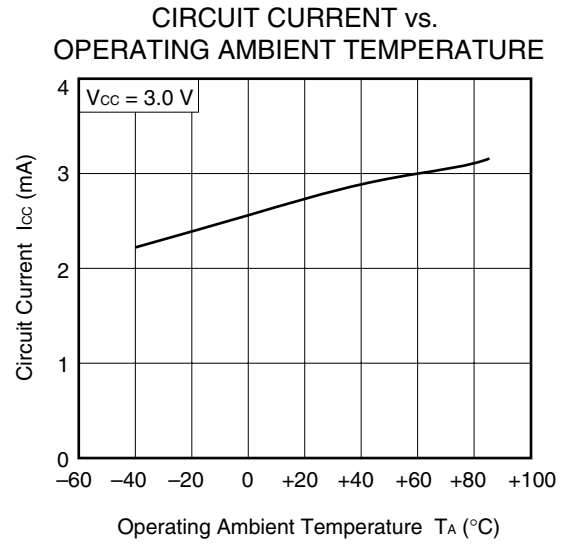
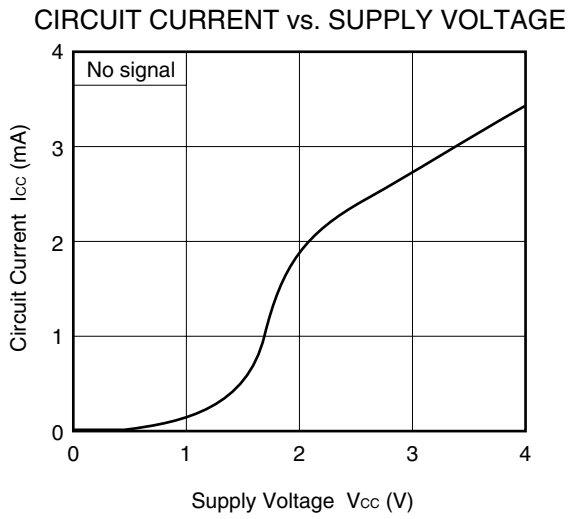

-  $\mu$ PC8128TB -

1.0 GHz output port matching

S-PARAMETERS (monitored at connector on board)

$T_A = +25^\circ\text{C}$ ,  $V_{CC} = V_{out} = 3.0\text{ V}$

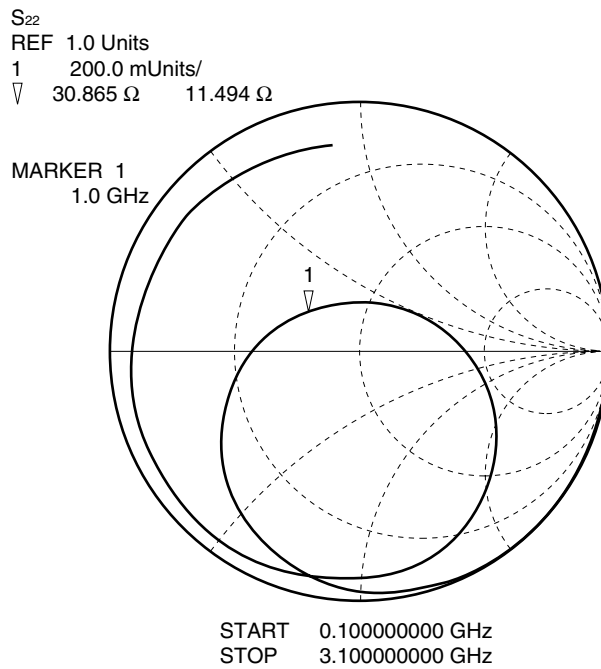
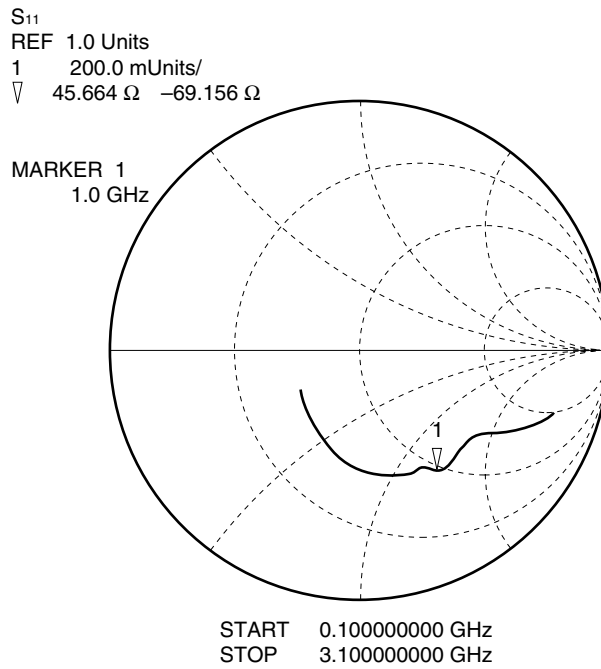

-  $\mu$ PC8128TB -

1.0 GHz output port matching

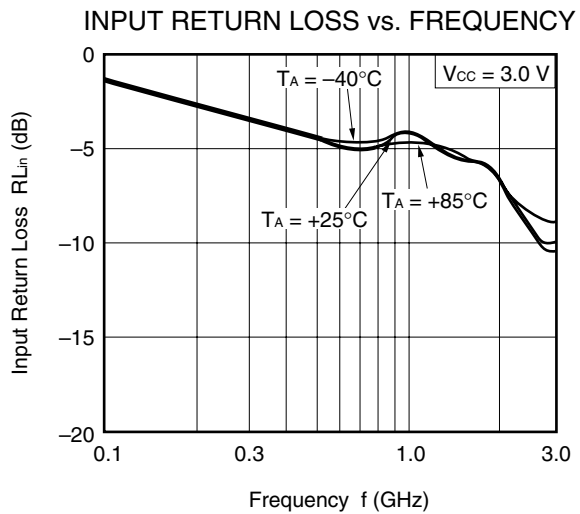
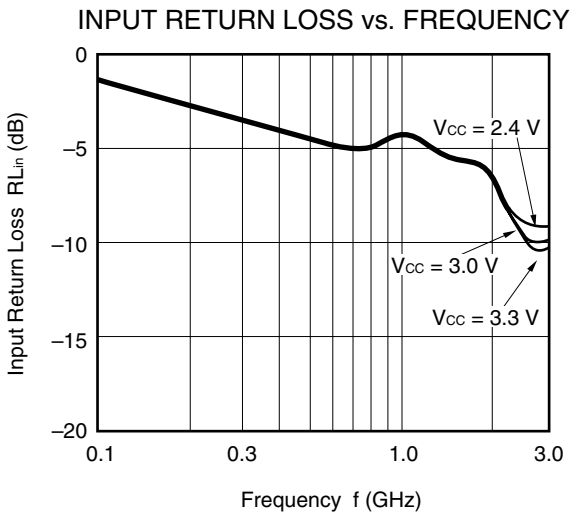
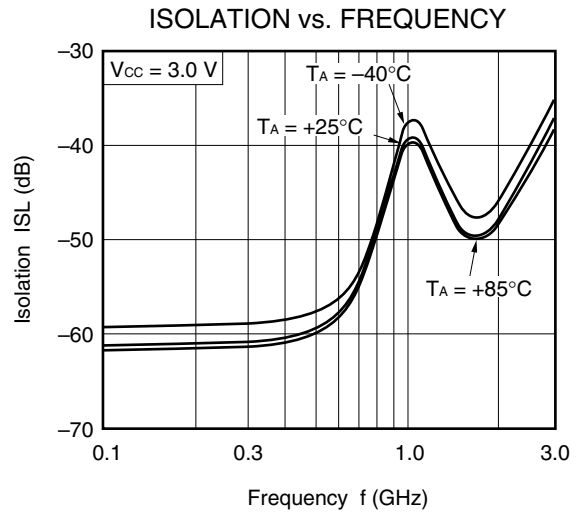
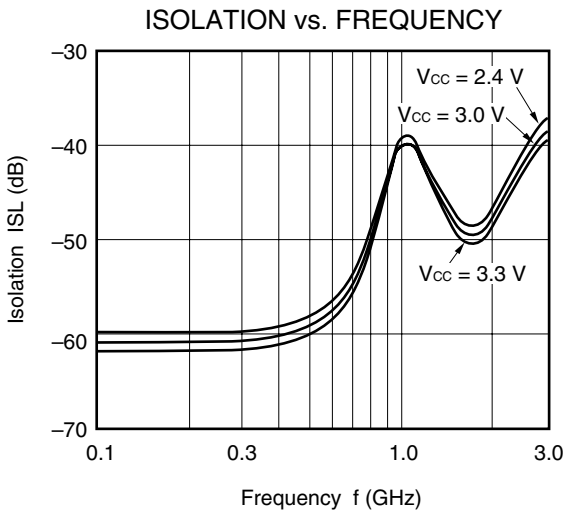
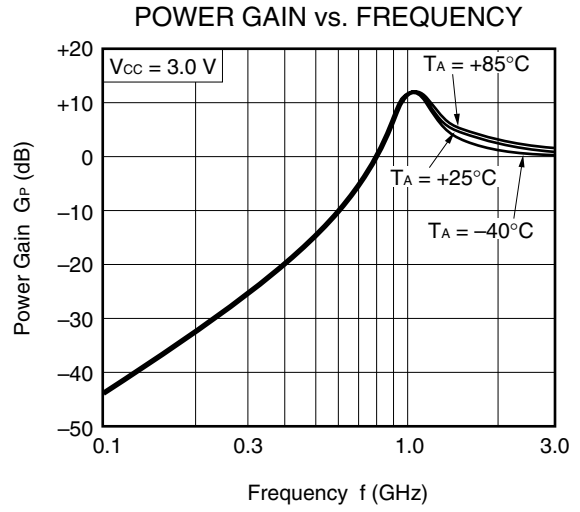
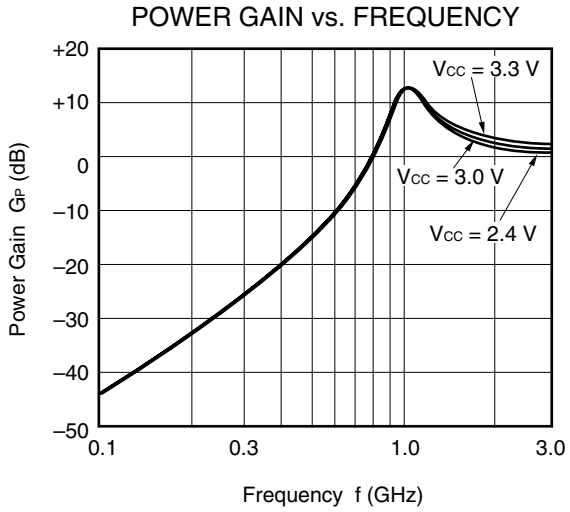

-  $\mu$ PC8128TB -

1.0 GHz output port matching

OUTPUT RETURN LOSS vs. FREQUENCY

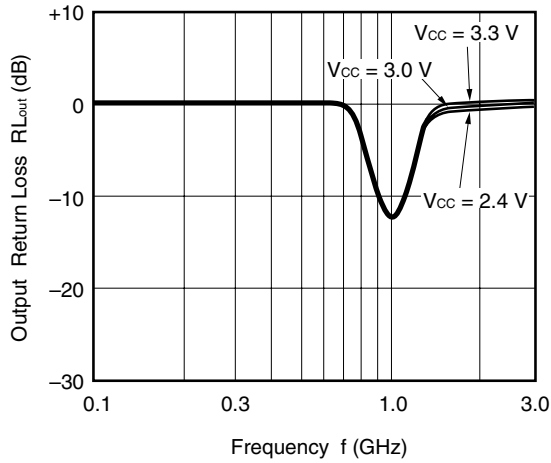

OUTPUT RETURN LOSS vs. FREQUENCY

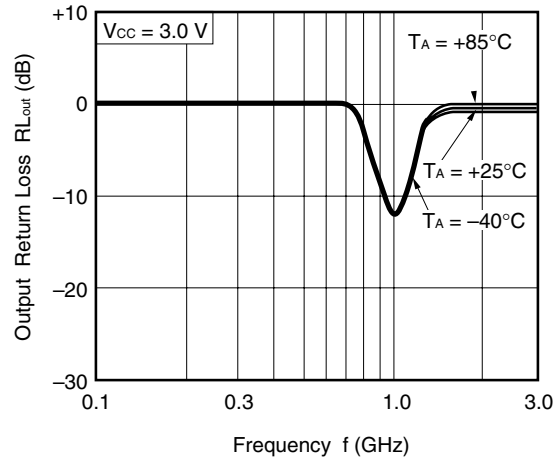

OUTPUT POWER vs. INPUT POWER

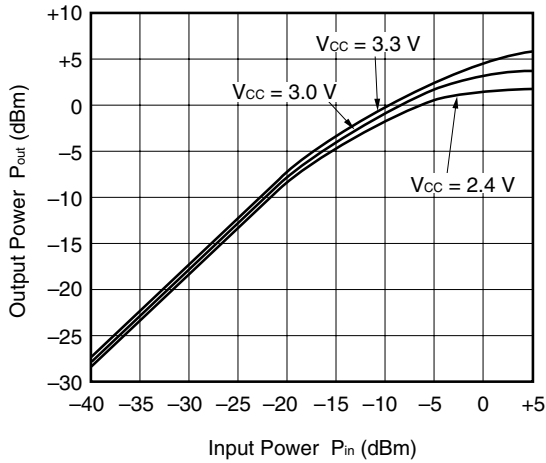

OUTPUT POWER vs. INPUT POWER

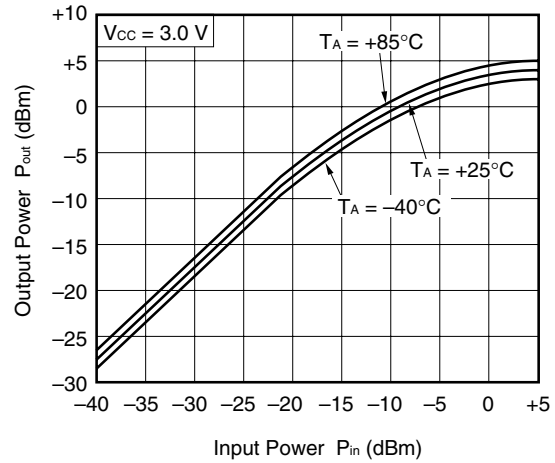

OUTPUT POWER OF EACH TONE, IM3 vs. INPUT POWER OF EACH TONE

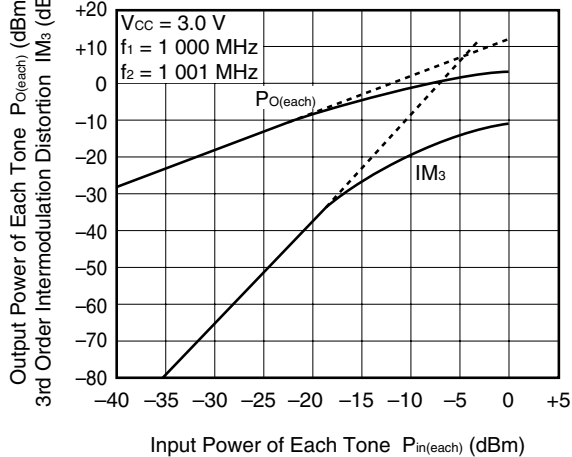

3RD ORDER INTERMODULATION DISTORTION vs. OUTPUT POWER OF EACH TONE

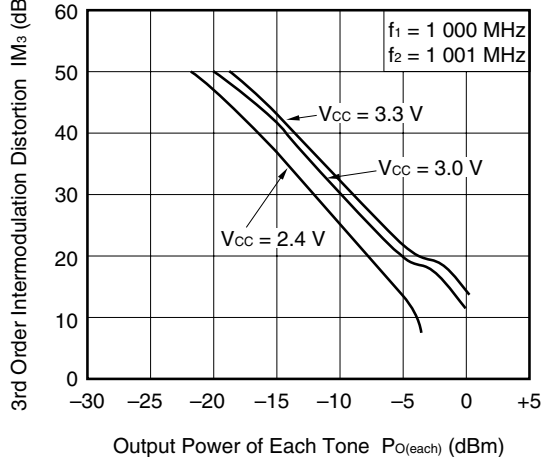



–  $\mu$ PC8128TB –

1.0 GHz output port matching

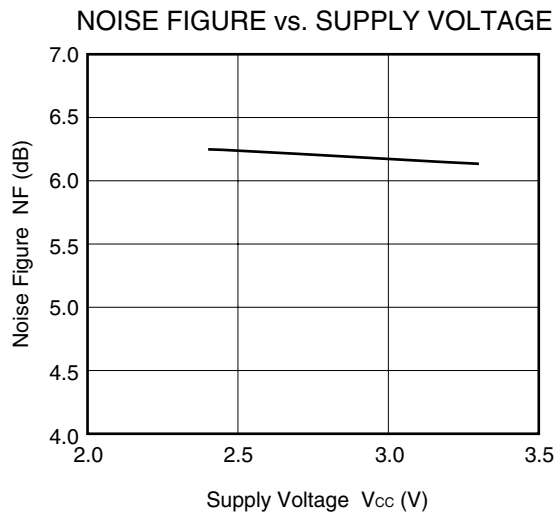

–  $\mu$ PC8128TB –

1.66 GHz output port matching

S-PARAMETERS (monitored at connector on board)

$T_A = +25^\circ\text{C}$ ,  $V_{CC} = V_{out} = 3.0\text{ V}$

S<sub>11</sub>  
 REF 1.0 Units  
 1 200.0 mUnits/  
 ▽ 27.846  $\Omega$  -43.406  $\Omega$

MARKER 1  
 1.66 GHz

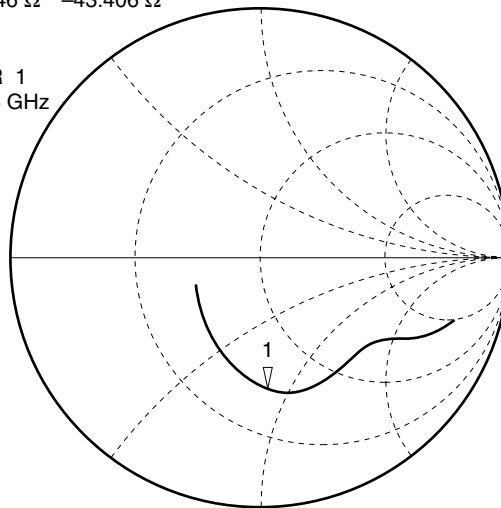

START 0.10000000 GHz  
 STOP 3.10000000 GHz

S<sub>22</sub>  
 REF 1.0 Units  
 1 200.0 mUnits/  
 ▽ 46.598  $\Omega$  -9.8574  $\Omega$

MARKER 1  
 1.66 GHz

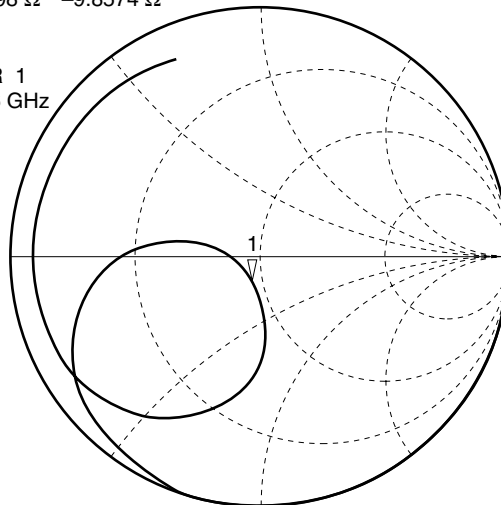

START 0.10000000 GHz  
 STOP 3.10000000 GHz

–  $\mu$ PC8128TB –

1.66 GHz output port matching

POWER GAIN vs. FREQUENCY

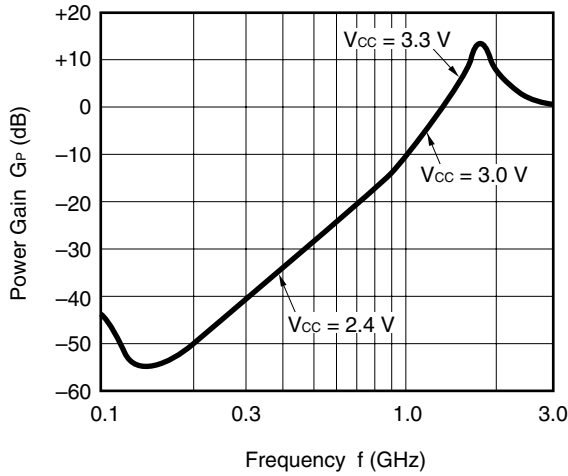

ISOLATION vs. FREQUENCY

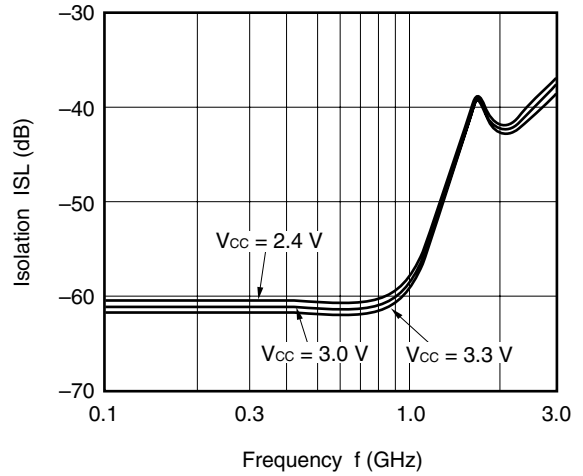

INPUT RETURN LOSS vs. FREQUENCY

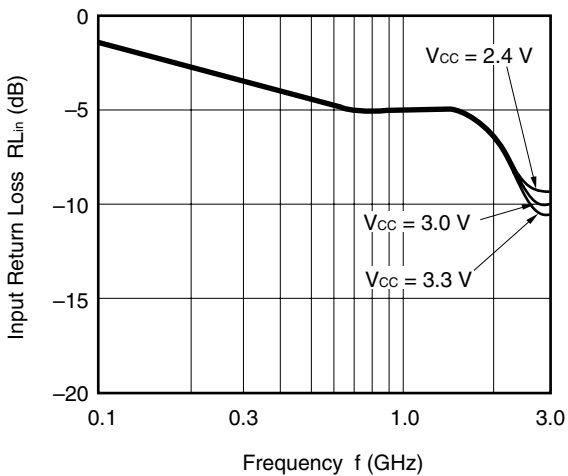

OUTPUT RETURN LOSS vs. FREQUENCY

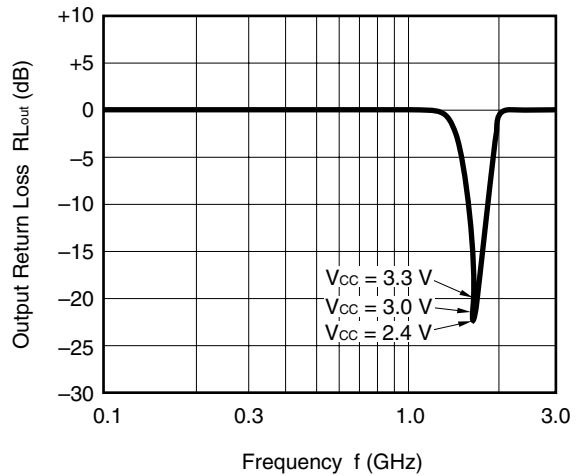

OUTPUT POWER vs. INPUT POWER

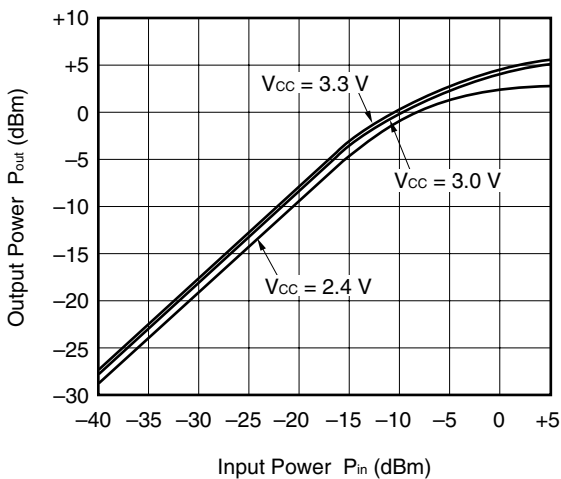

OUTPUT POWER OF EACH TONE,  $IM_3$  vs. INPUT POWER OF EACH TONE

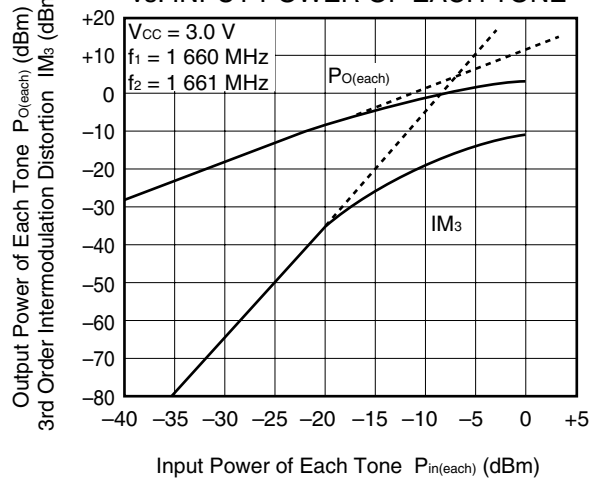

–  $\mu$ PC8128TB –

1.66 GHz output port matching

3RD ORDER INTERMODULATION DISTORTION vs. OUTPUT POWER OF EACH TONE

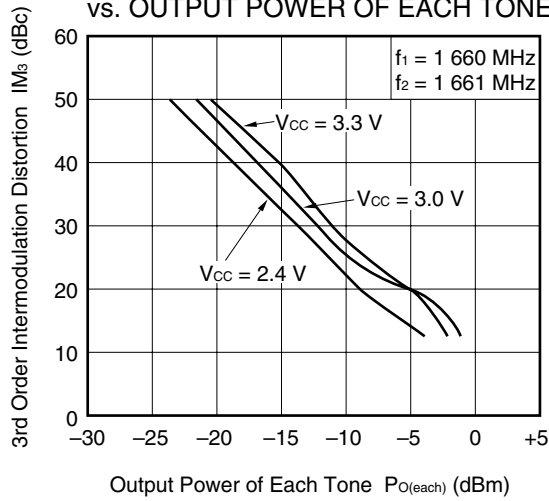

NOISE FIGURE vs. SUPPLY VOLTAGE

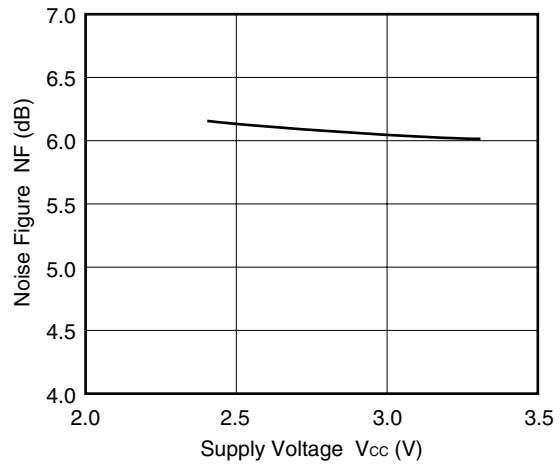

–  $\mu$ PC8128TB –

1.9 GHz output port matching

S-PARAMETERS (monitored at connector on board)

$T_A = +25^\circ\text{C}$ ,  $V_{CC} = V_{out} = 3.0\text{ V}$

S<sub>11</sub>  
 REF 1.0 Units  
 1 200.0 mUnits/  
 ▽ 24.725  $\Omega$  -34.01  $\Omega$

MARKER 1  
 1.9 GHz

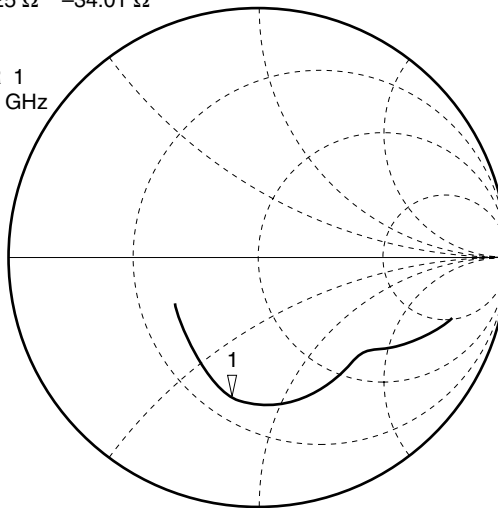

START 0.10000000 GHz  
 STOP 3.10000000 GHz

S<sub>22</sub>  
 REF 1.0 Units  
 1 200.0 mUnits/  
 ▽ 74.719  $\Omega$  -22.016  $\Omega$

MARKER 1  
 1.9 GHz

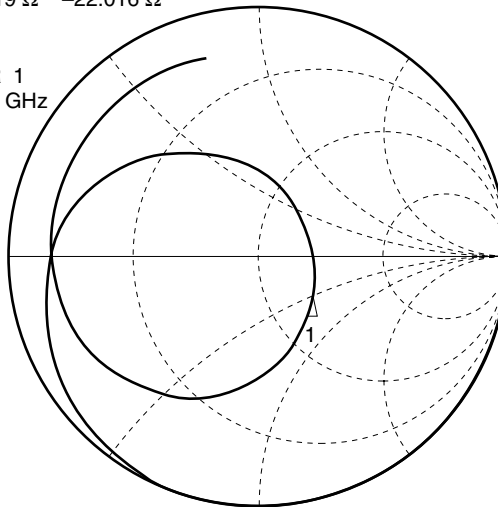

START 0.10000000 GHz  
 STOP 3.10000000 GHz

-  $\mu$ PC8128TB -

1.9 GHz output port matching

POWER GAIN vs. FREQUENCY

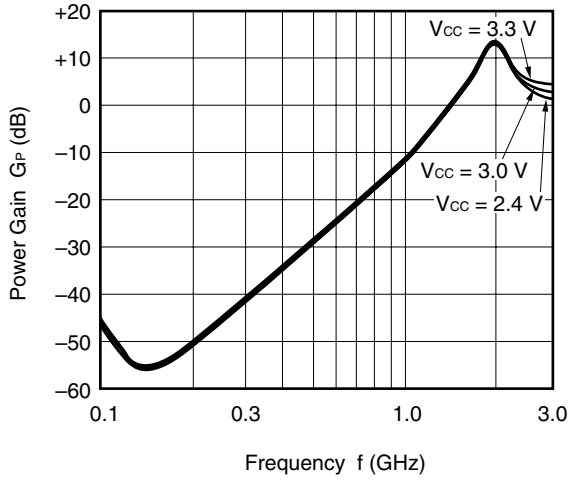

ISOLATION vs. FREQUENCY

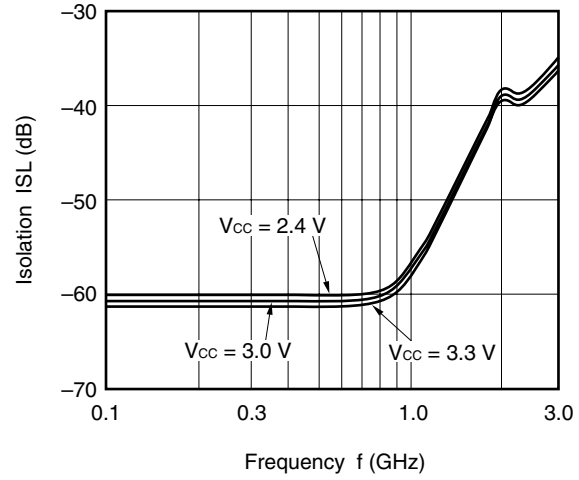

INPUT RETURN LOSS vs. FREQUENCY

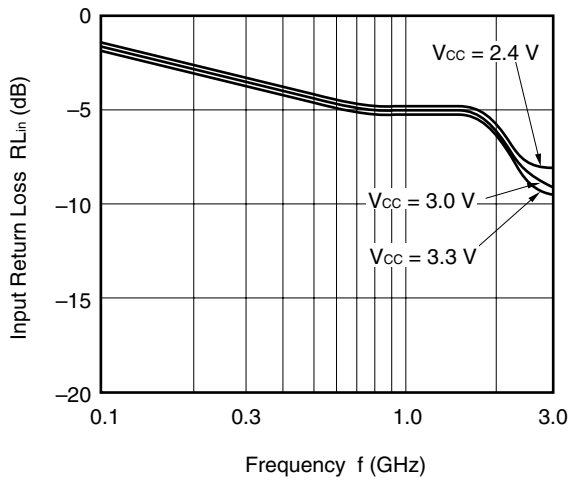

OUTPUT RETURN LOSS vs. FREQUENCY

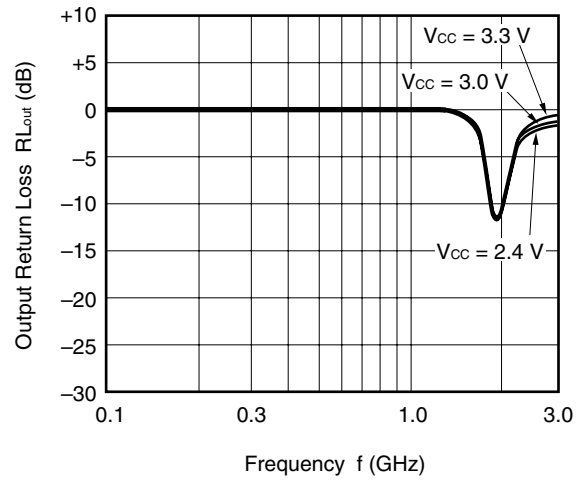

OUTPUT POWER vs. INPUT POWER

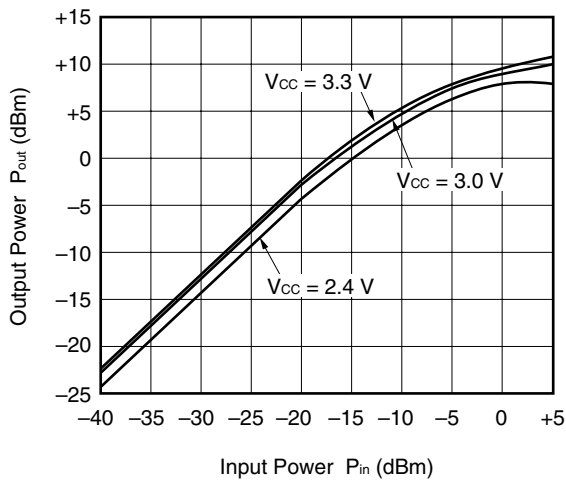

OUTPUT POWER OF EACH TONE,  $IM_3$  vs. INPUT POWER OF EACH TONE

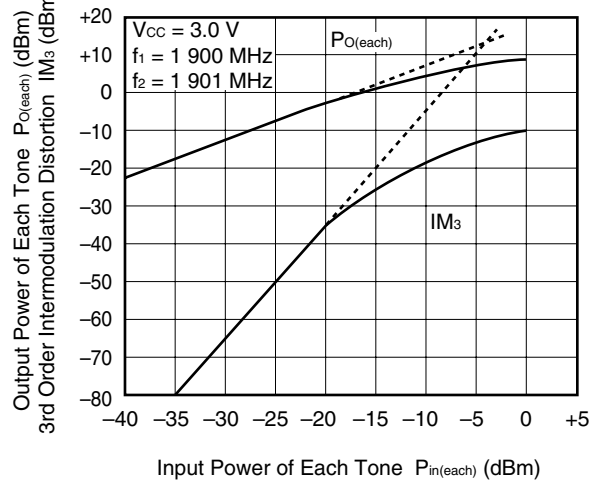

–  $\mu$ PC8128TB –

1.9 GHz output port matching

3RD ORDER INTERMODULATION DISTORTION vs. OUTPUT POWER OF EACH TONE

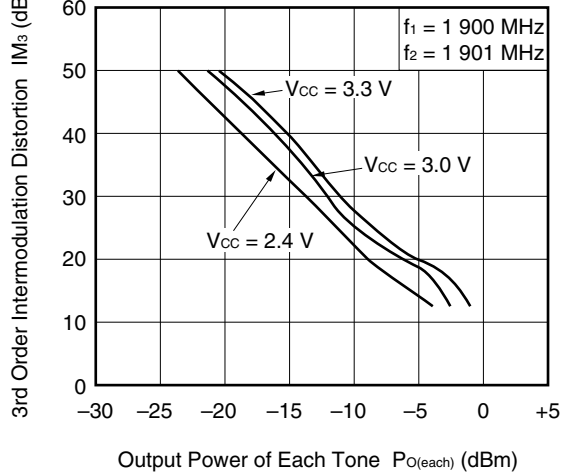

NOISE FIGURE vs. SUPPLY VOLTAGE

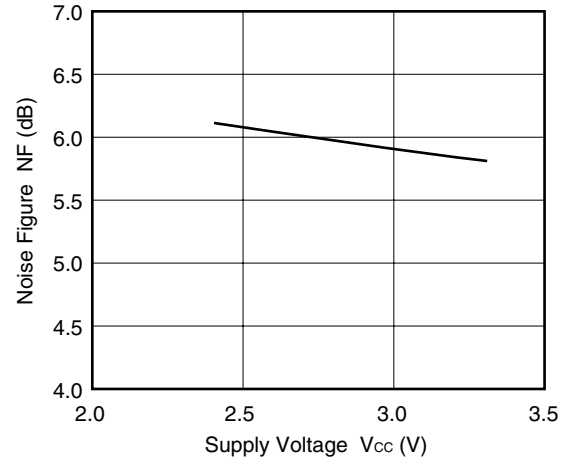

S-PARAMETERS ( $T_A = +25^\circ\text{C}$ ,  $V_{CC} = V_{out} = 3.0\text{ V}$ )

–  $\mu$ PC8128TB –

S<sub>11</sub>–Frequency

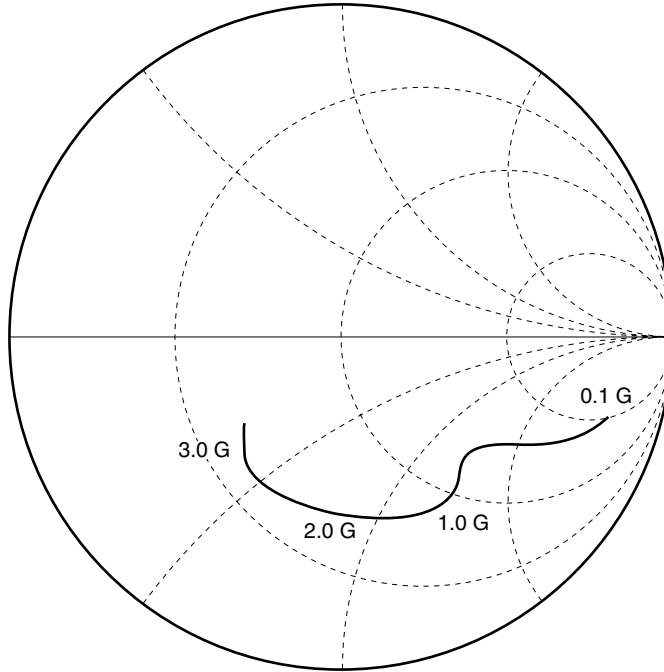

S<sub>22</sub>–Frequency

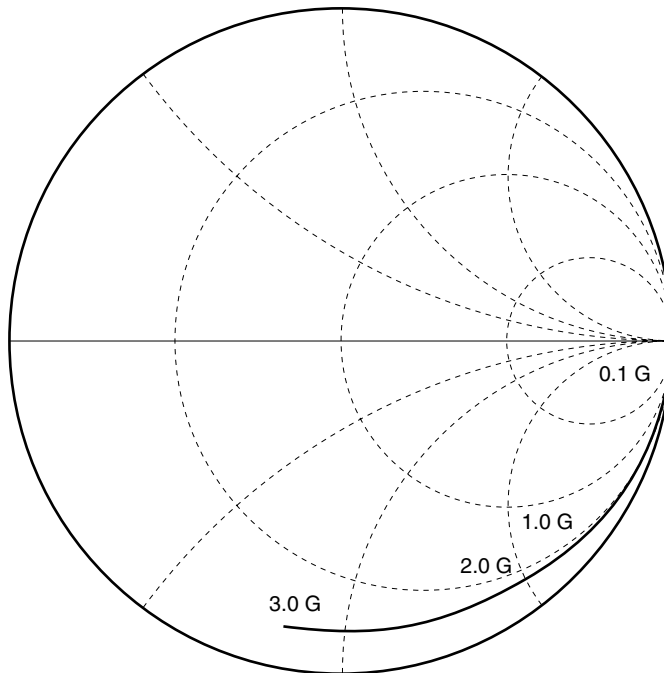



TYPICAL S-PARAMETER VALUES (T<sub>A</sub> = +25°C)

$\mu$ PC8128TB

V<sub>CC</sub> = V<sub>out</sub> = 3.0 V, I<sub>CC</sub> = 2.8 mA

FREQUENCY MHz	S <sub>11</sub>		S <sub>21</sub>		S <sub>12</sub>		S <sub>22</sub>	
	MAG.	ANG.	MAG.	ANG.	MAG.	ANG.	MAG.	ANG.
100.0000	0.859	-14.5	1.089	-176.0	0.001	176.7	1.005	-1.7
200.0000	0.769	-23.8	1.138	-173.2	0.001	142.6	1.019	-4.2
300.0000	0.694	-27.1	1.208	-171.0	0.003	112.3	1.015	-5.8
400.0000	0.637	-30.1	1.336	-171.7	0.005	88.8	0.996	-8.7
500.0000	0.595	-32.4	1.478	-172.8	0.005	77.7	0.976	-10.9
600.0000	0.568	-35.9	1.623	-175.6	0.005	64.1	0.976	-12.8
700.0000	0.555	-40.7	1.822	-179.0	0.006	73.7	0.983	-14.1
800.0000	0.569	-45.0	1.955	176.9	0.007	64.2	0.988	-15.5
900.0000	0.597	-49.4	2.147	172.5	0.007	72.5	0.973	-17.4
1000.0000	0.633	-52.6	2.307	166.8	0.008	49.9	0.945	-19.9
1100.0000	0.643	-56.3	2.468	160.6	0.008	66.8	0.928	-22.0
1200.0000	0.644	-59.7	2.572	153.6	0.007	48.8	0.934	-24.1
1300.0000	0.611	-64.3	2.677	144.2	0.007	45.3	0.950	-24.8
1400.0000	0.585	-69.5	2.704	137.3	0.005	64.5	0.938	-26.6
1500.0000	0.562	-75.1	2.693	128.8	0.005	66.0	0.913	-28.2
1600.0000	0.559	-80.5	2.712	122.7	0.005	93.6	0.898	-30.1
1700.0000	0.547	-85.4	2.640	116.3	0.006	83.5	0.892	-32.0
1800.0000	0.540	-89.5	2.665	110.4	0.005	101.6	0.893	-33.6
1900.0000	0.524	-93.2	2.599	104.5	0.005	115.4	0.896	-34.7
2000.0000	0.503	-97.8	2.582	98.5	0.006	110.9	0.895	-36.5
2100.0000	0.474	-103.5	2.500	93.1	0.007	129.4	0.877	-38.6
2200.0000	0.461	-110.0	2.472	86.7	0.008	130.5	0.873	-40.4
2300.0000	0.465	-116.2	2.453	80.9	0.009	137.8	0.878	-41.9
2400.0000	0.475	-121.0	2.426	74.8	0.010	133.3	0.877	-43.5
2500.0000	0.488	-123.1	2.364	70.4	0.012	139.0	0.871	-45.4
2600.0000	0.491	-125.0	2.310	63.9	0.011	140.8	0.864	-47.9
2700.0000	0.480	-125.1	2.282	61.1	0.014	142.6	0.855	-51.1
2800.0000	0.460	-127.0	2.159	56.3	0.014	140.7	0.851	-53.0
2900.0000	0.437	-129.4	2.205	51.4	0.016	141.5	0.867	-55.1
3000.0000	0.410	-133.4	2.085	48.8	0.018	143.2	0.861	-57.0
3100.0000	0.401	-137.8	2.038	42.4	0.019	142.1	0.855	-60.0

–  $\mu$ PC8151TB –

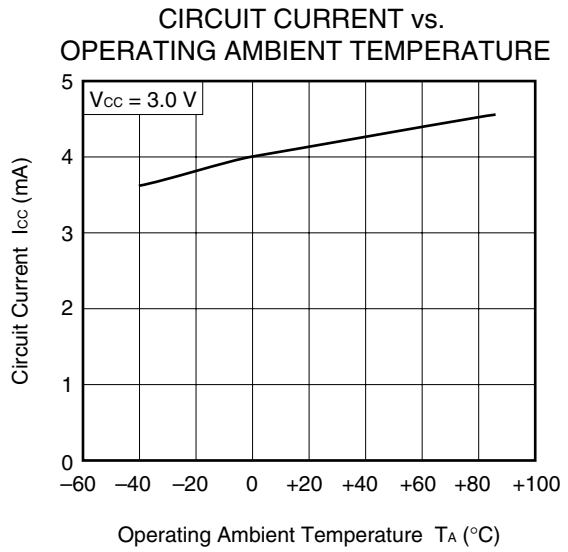
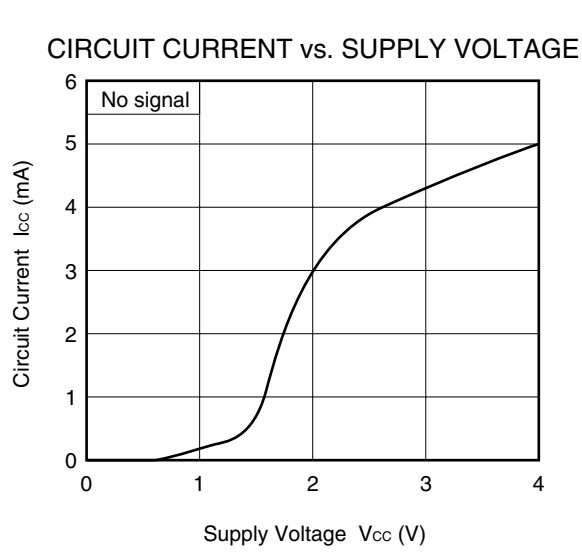

–  $\mu$ PC8151TB –

1.0 GHz output port matching

S-PARAMETERS (monitored at connector on board)

$T_A = +25^\circ\text{C}$ ,  $V_{CC} = V_{out} = 3.0\text{ V}$

S<sub>11</sub>  
 REF 1.0 Units  
 1 200.0 mUnits/  
 ▽ 52.156  $\Omega$  -69.48  $\Omega$

MARKER 1  
 1.0 GHz

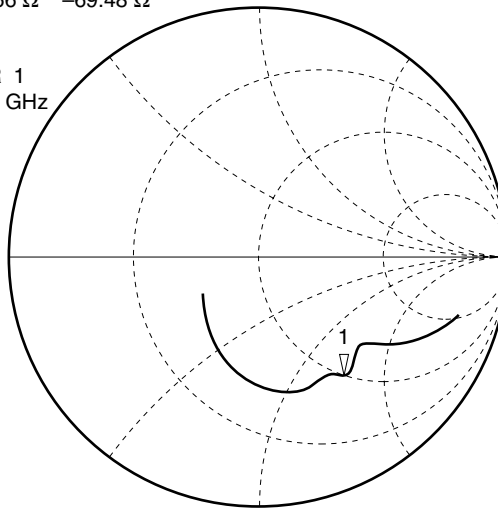

START 0.10000000 GHz  
 STOP 3.10000000 GHz

S<sub>22</sub>  
 REF 1.0 Units  
 1 200.0 mUnits/  
 ▽ 32.893  $\Omega$  16.221  $\Omega$

MARKER 1  
 1.0 GHz

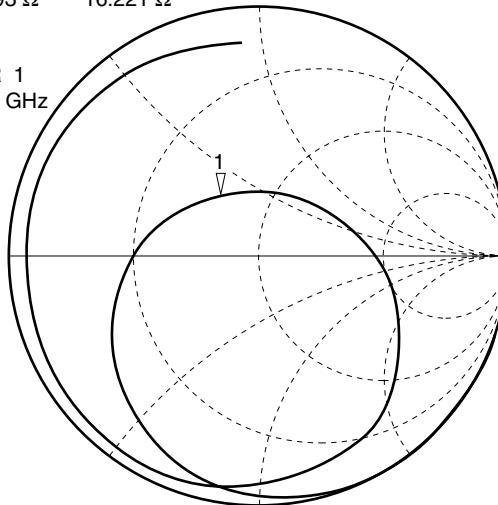

START 0.10000000 GHz  
 STOP 3.10000000 GHz

-  $\mu$ PC8151TB -

1.0 GHz output port matching

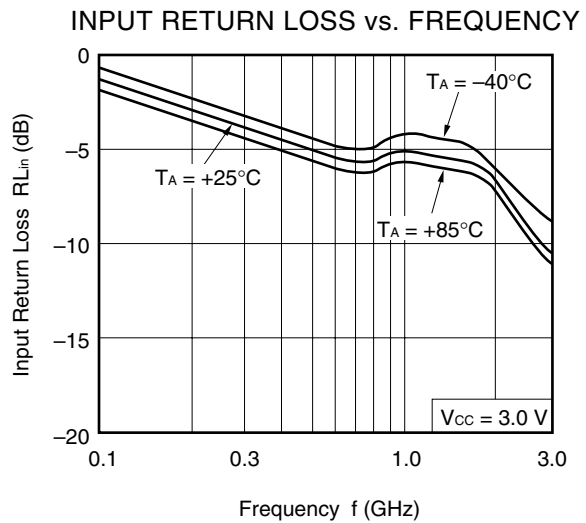
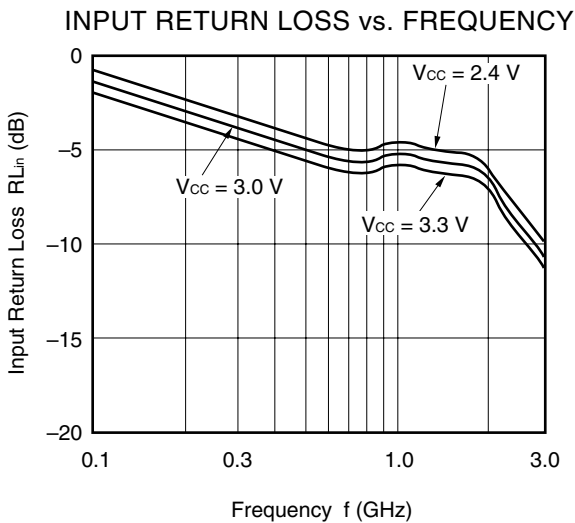
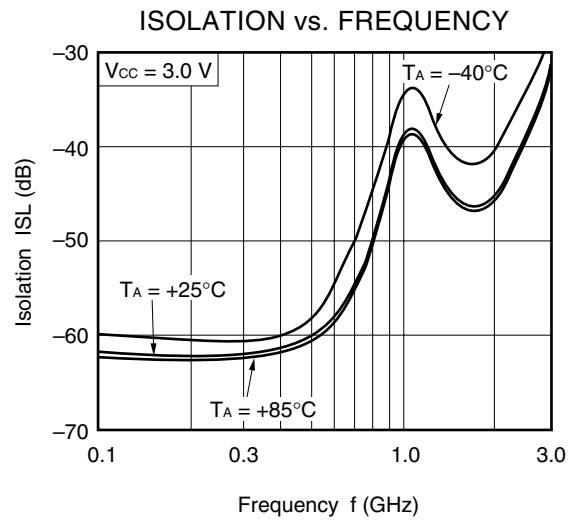
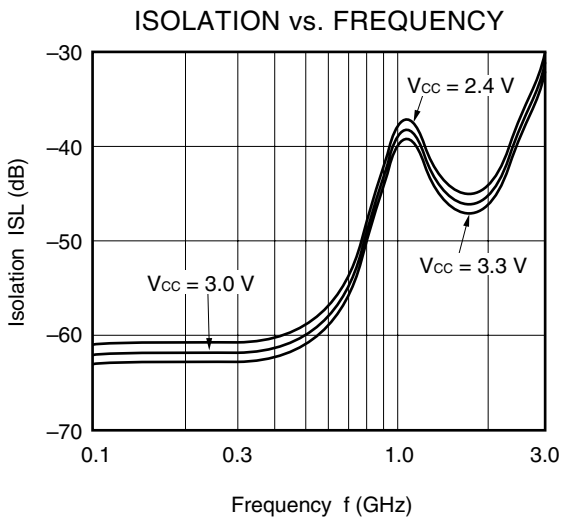
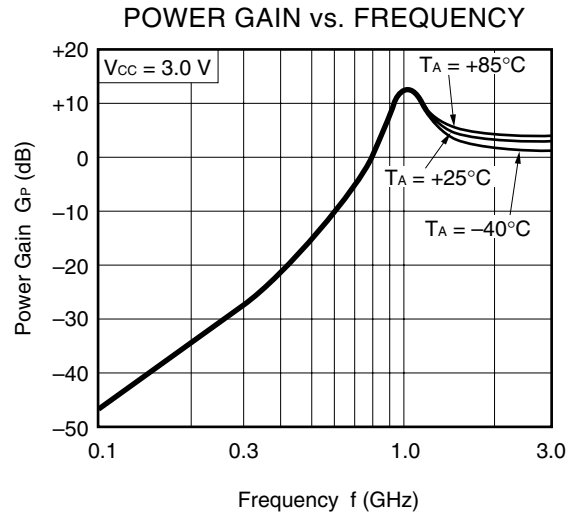
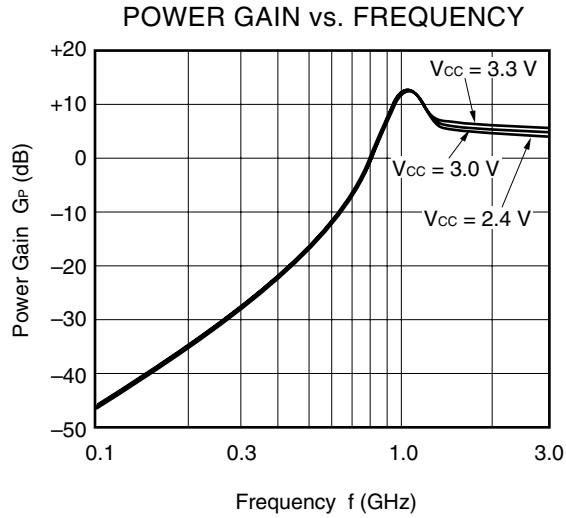

–  $\mu$ PC8151TB –

1.0 GHz output port matching

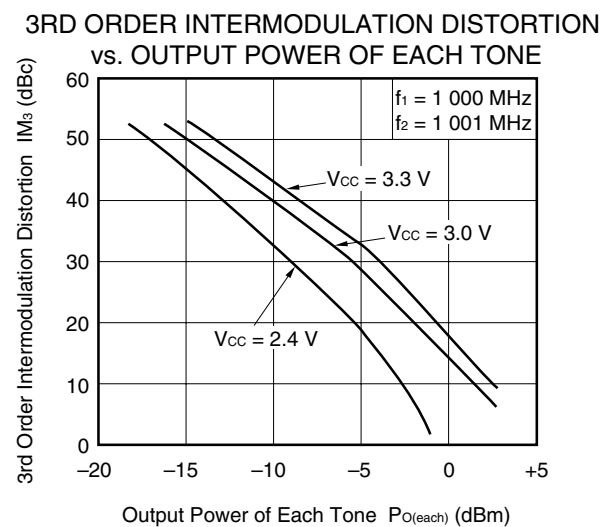
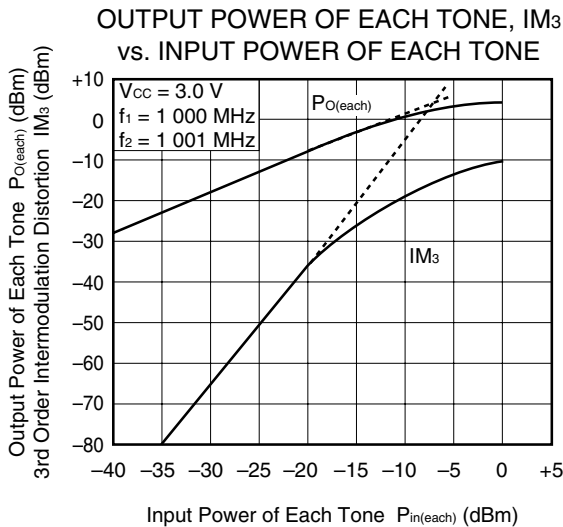
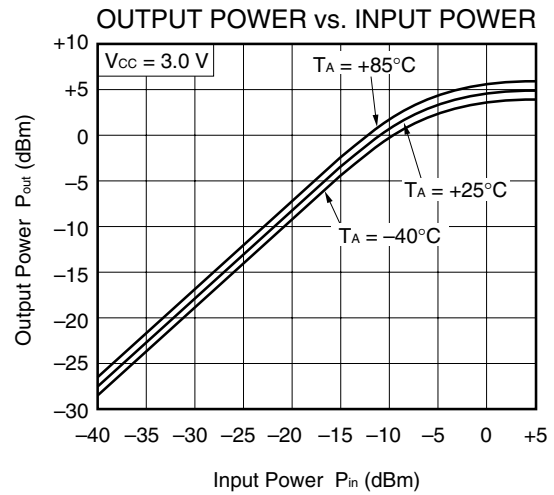
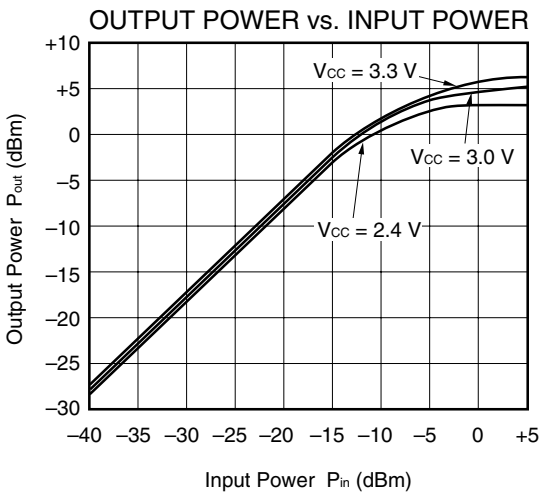
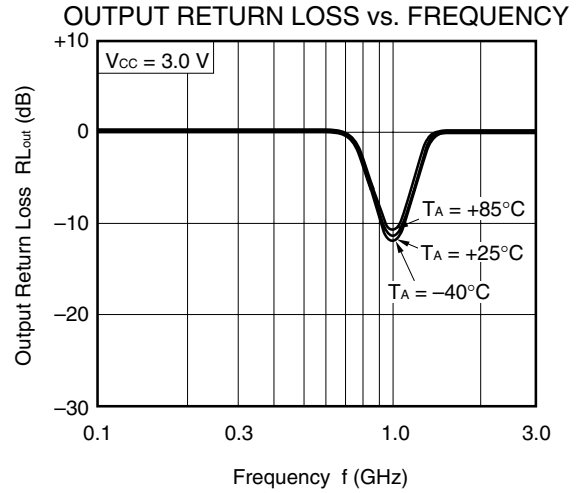
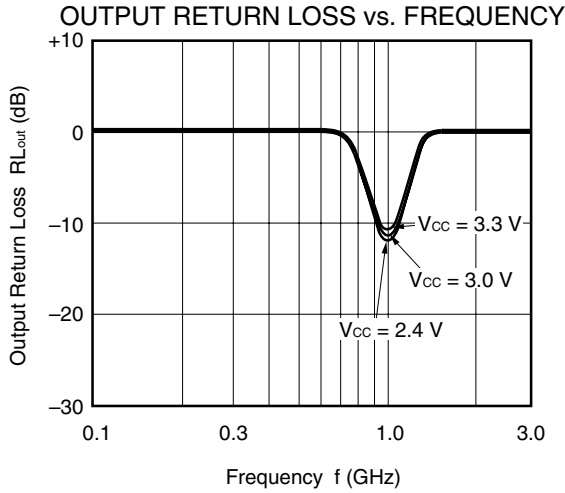

–  $\mu$ PC8151TB –

1.0 GHz output port matching

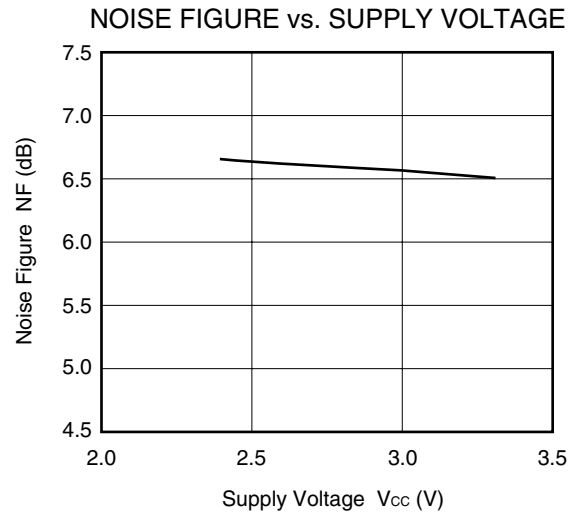

–  $\mu$ PC8151TB –

1.66 GHz output port matching

S-PARAMETERS (monitored at connector on board)

$T_A = +25^\circ\text{C}$ ,  $V_{CC} = V_{out} = 3.0\text{ V}$

S<sub>11</sub>  
REF 1.0 Units  
1 200.0 mUnits/  
∇ 26.748 Ω -46.359 Ω

MARKER 1  
1.66 GHz

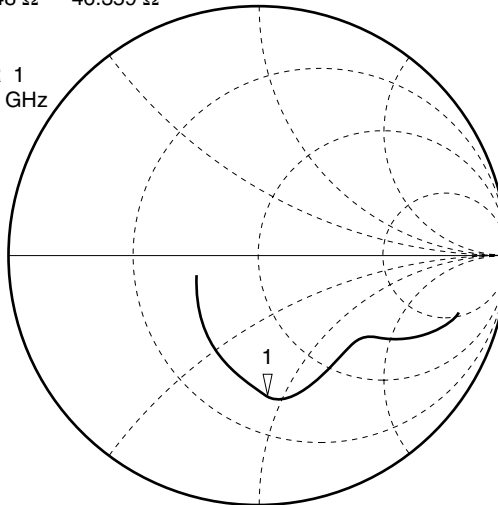

START 0.10000000 GHz  
STOP 3.10000000 GHz

S<sub>22</sub>  
REF 1.0 Units  
1 200.0 mUnits/  
∇ 49.086 Ω -23.154 Ω

MARKER 1  
1.66 GHz

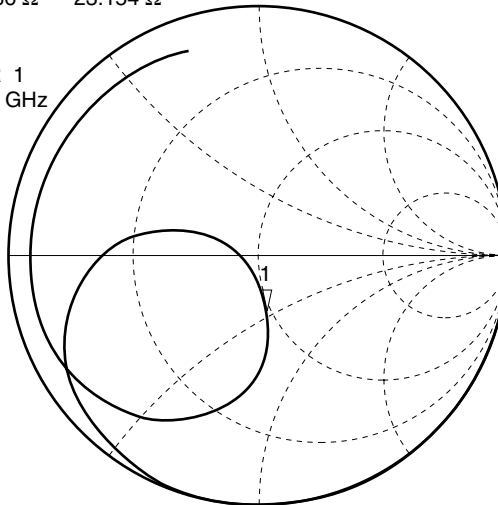

START 0.10000000 GHz  
STOP 3.10000000 GHz

-  $\mu$ PC8151TB -

1.66 GHz output port matching

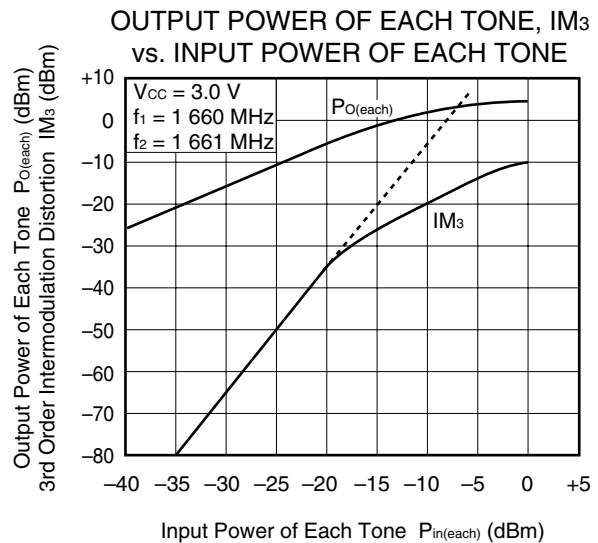
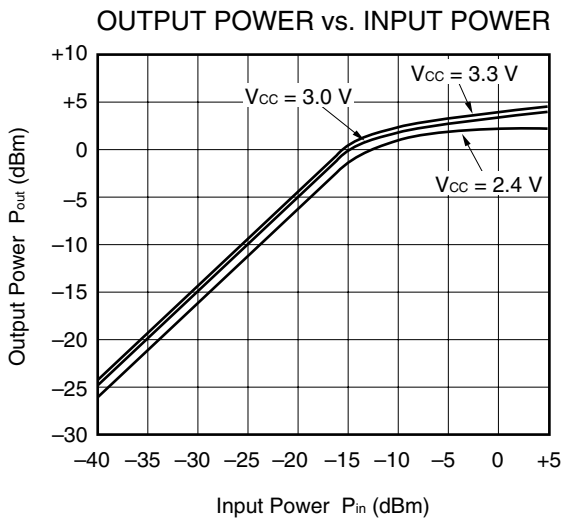
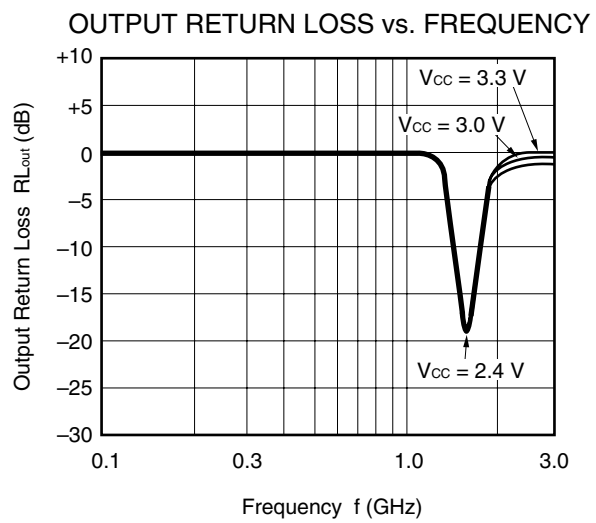
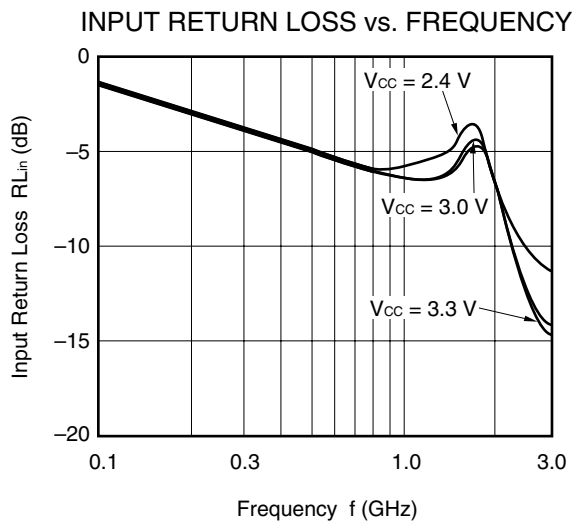
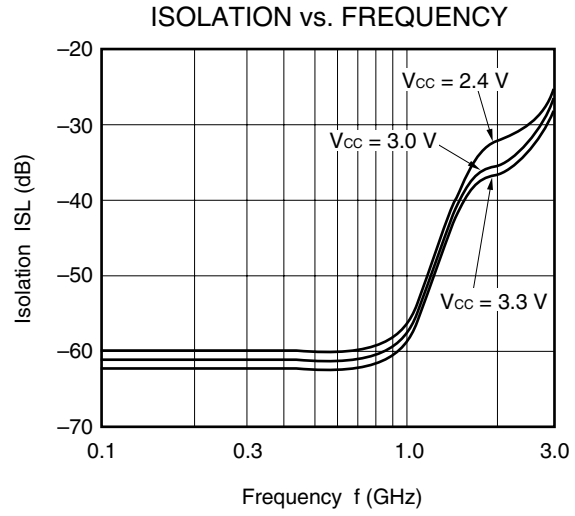
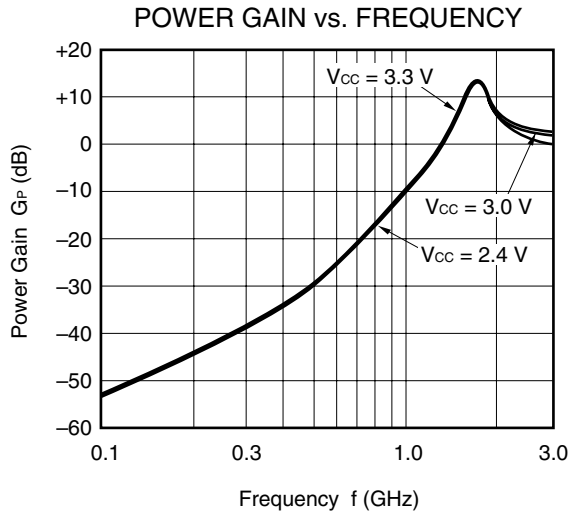



–  $\mu$ PC8151TB –

1.66 GHz output port matching

3RD ORDER INTERMODULATION DISTORTION vs. OUTPUT POWER OF EACH TONE

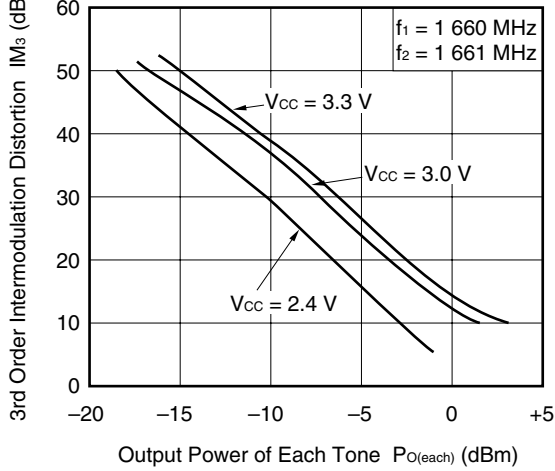

NOISE FIGURE vs. SUPPLY VOLTAGE

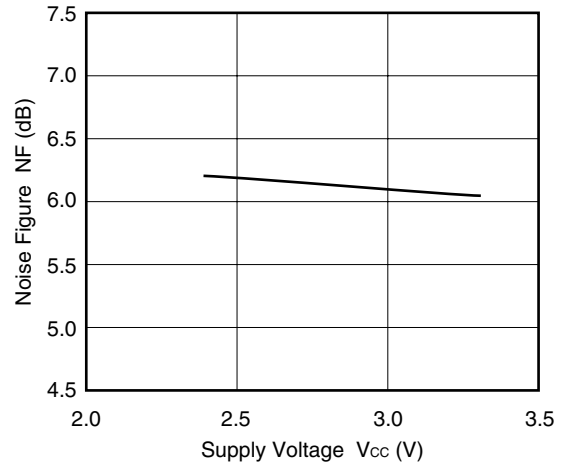

–  $\mu$ PC8151TB –

1.9 GHz output port matching

S-PARAMETERS (monitored at connector on board)

$T_A = +25^\circ\text{C}$ ,  $V_{CC} = V_{out} = 3.0\text{ V}$

S<sub>11</sub>  
 REF 1.0 Units  
 1 200.0 mUnits/  
 ▽ 24.301  $\Omega$  -37.246  $\Omega$

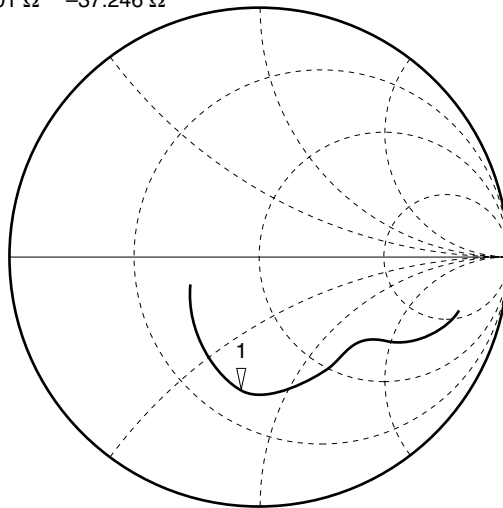

START 0.10000000 GHz  
 STOP 3.10000000 GHz

S<sub>22</sub>  
 REF 1.0 Units  
 1 200.0 mUnits/  
 ▽ 64.633  $\Omega$  -35.777  $\Omega$

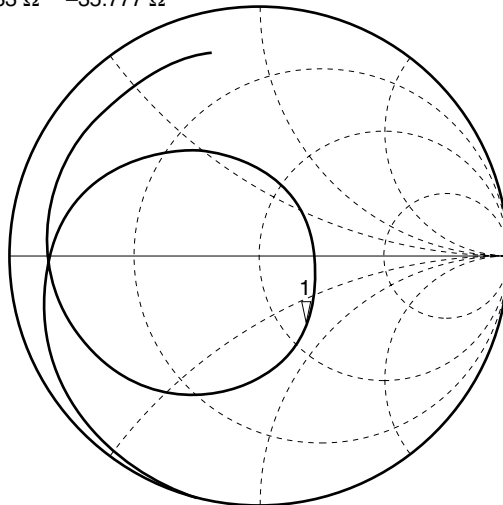

START 0.10000000 GHz  
 STOP 3.10000000 GHz

-  $\mu$ PC8151TB -

1.9 GHz output port matching

POWER GAIN vs. FREQUENCY

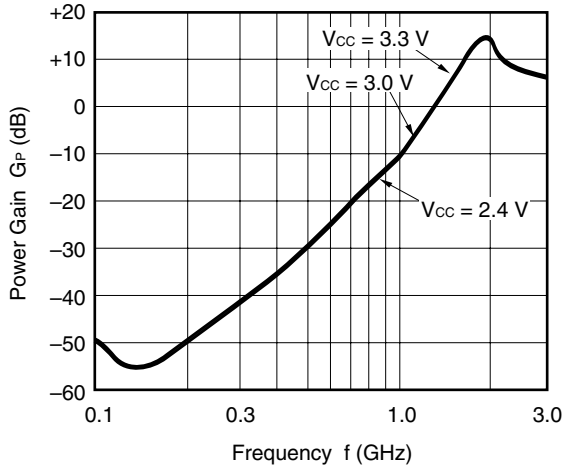

ISOLATION vs. FREQUENCY

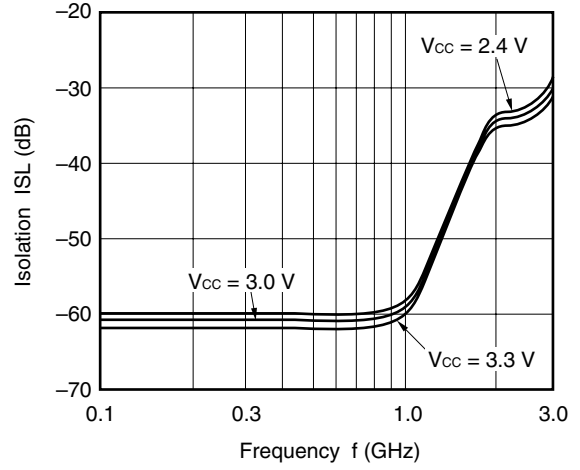

INPUT RETURN LOSS vs. FREQUENCY

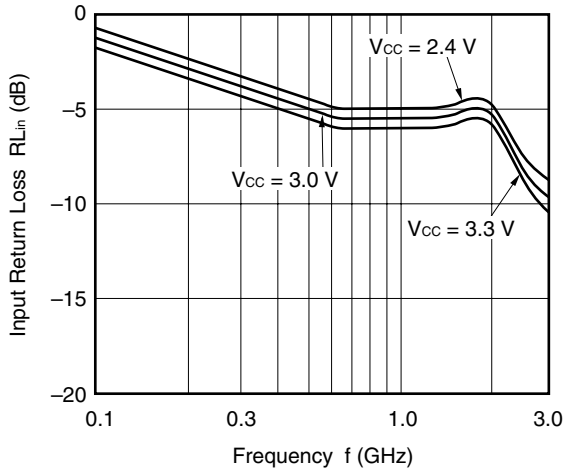

OUTPUT RETURN LOSS vs. FREQUENCY

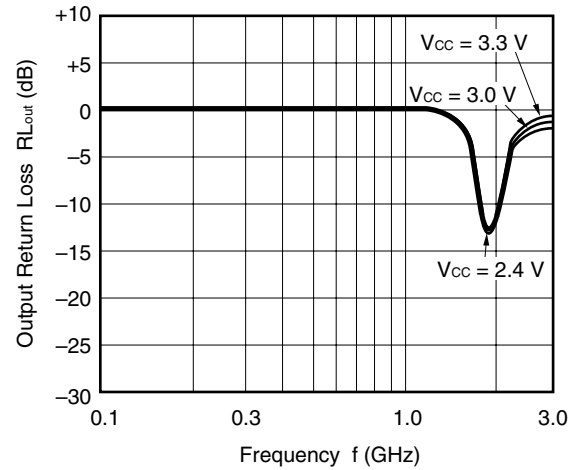

OUTPUT POWER vs. INPUT POWER

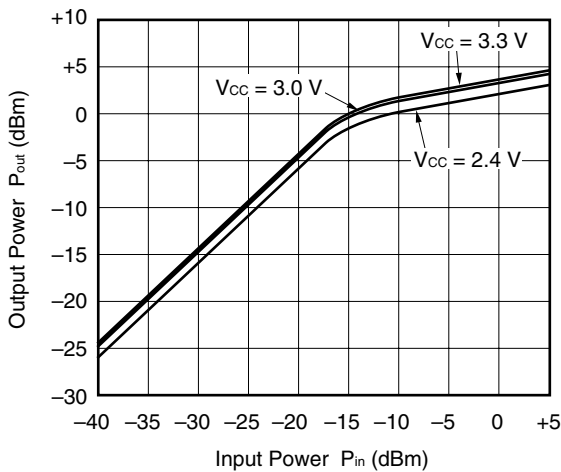

OUTPUT POWER OF EACH TONE, IM3 vs. INPUT POWER OF EACH TONE

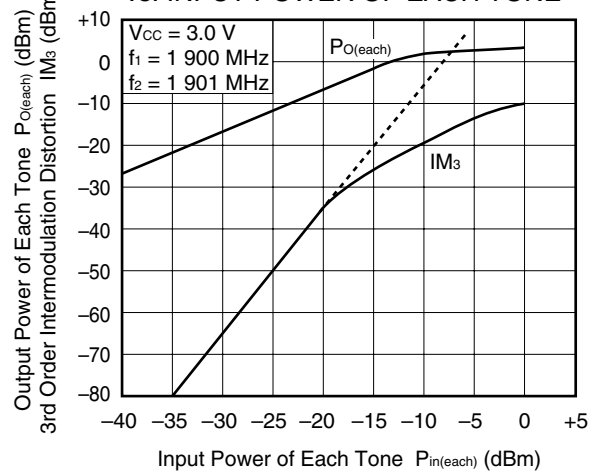

–  $\mu$ PC8151TB –

1.9 GHz output port matching

3RD ORDER INTERMODULATION DISTORTION vs. OUTPUT POWER OF EACH TONE

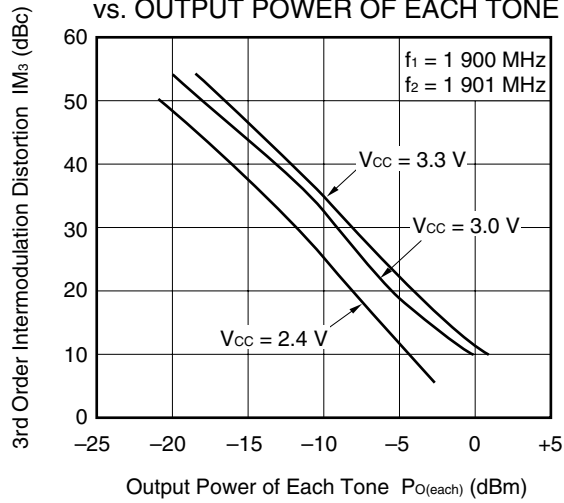

NOISE FIGURE vs. SUPPLY VOLTAGE

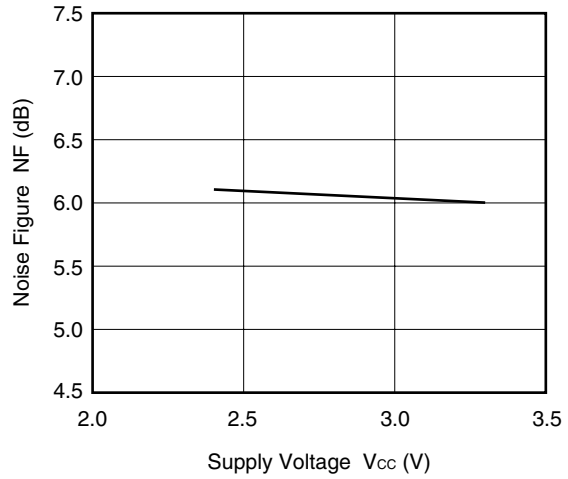

S-PARAMETERS ( $T_A = +25^\circ\text{C}$ ,  $V_{CC} = V_{out} = 3.0\text{ V}$ )

–  $\mu$ PC8151TB –

S<sub>11</sub>–Frequency

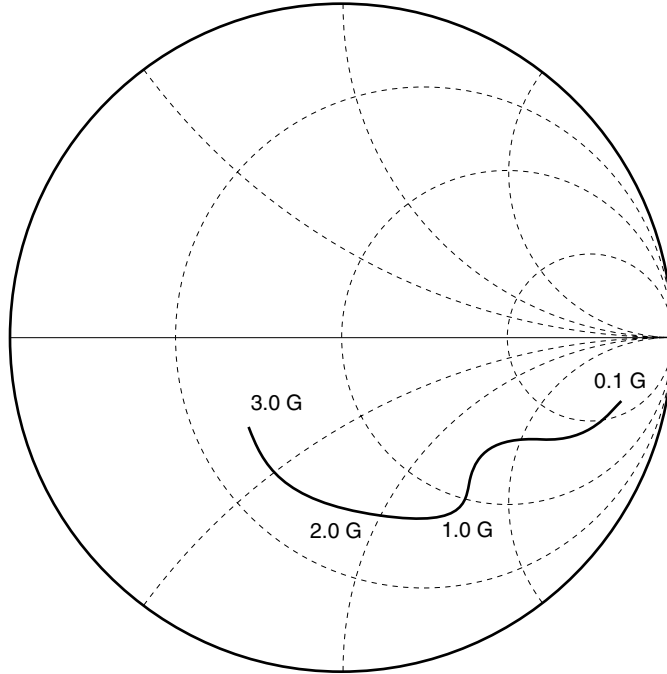

S<sub>22</sub>–Frequency

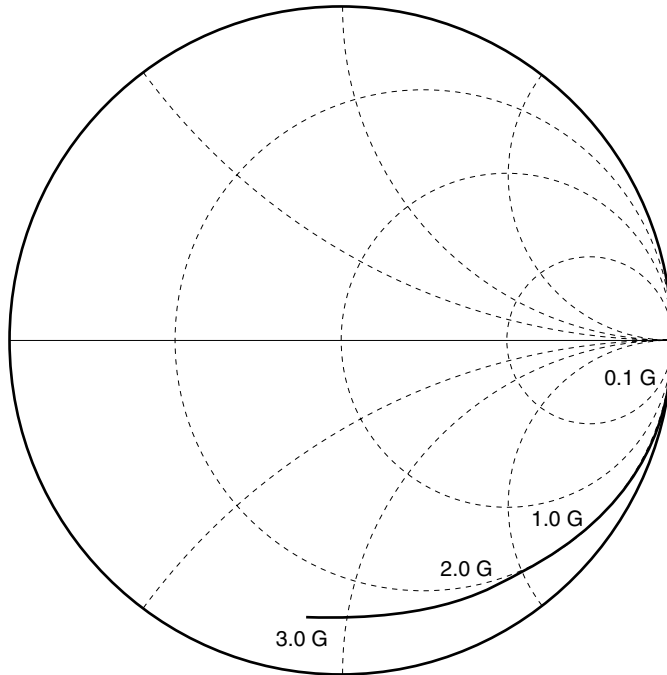

TYPICAL S-PARAMETER VALUES (T<sub>A</sub> = +25°C)

$\mu$ PC8151TB

V<sub>CC</sub> = V<sub>out</sub> = 3.0 V, I<sub>CC</sub> = 4.2 mA

FREQUENCY MHz	S <sub>11</sub>		S <sub>21</sub>		S <sub>12</sub>		S <sub>22</sub>	
	MAG.	ANG.	MAG.	ANG.	MAG.	ANG.	MAG.	ANG.
100.0000	0.843	-16.0	1.202	-178.9	0.000	69.5	0.996	-3.3
200.0000	0.752	-27.1	1.197	-177.5	0.003	120.2	1.009	-6.9
300.0000	0.666	-32.4	1.221	-175.4	0.003	103.2	0.998	-9.9
400.0000	0.603	-36.8	1.299	-174.5	0.004	92.8	0.986	-13.8
500.0000	0.555	-40.5	1.398	-174.0	0.005	88.8	0.968	-17.3
600.0000	0.528	-44.8	1.513	-174.9	0.005	95.2	0.968	-20.4
700.0000	0.517	-49.9	1.691	-176.2	0.007	67.5	0.971	-23.1
800.0000	0.525	-54.4	1.815	-178.2	0.007	72.4	0.972	-25.8
900.0000	0.545	-58.9	2.008	179.5	0.006	84.5	0.960	-29.3
1000.0000	0.571	-62.8	2.189	175.7	0.009	78.3	0.936	-32.8
1100.0000	0.580	-67.3	2.399	171.2	0.007	60.0	0.926	-36.3
1200.0000	0.588	-71.3	2.560	165.9	0.007	89.5	0.933	-39.5
1300.0000	0.571	-76.4	2.736	157.5	0.008	67.2	0.941	-42.0
1400.0000	0.563	-82.3	2.865	151.3	0.008	79.6	0.930	-45.0
1500.0000	0.553	-88.8	2.946	143.3	0.006	79.9	0.906	-48.1
1600.0000	0.552	-95.2	3.077	137.0	0.006	91.4	0.895	-51.5
1700.0000	0.551	-101.5	3.083	130.1	0.009	102.3	0.888	-54.8
1800.0000	0.550	-107.5	3.174	123.9	0.009	100.5	0.884	-57.3
1900.0000	0.536	-113.3	3.164	117.4	0.006	109.5	0.885	-60.2
2000.0000	0.517	-119.8	3.193	110.7	0.009	115.9	0.881	-63.4
2100.0000	0.495	-127.1	3.149	104.4	0.010	124.2	0.870	-66.6
2200.0000	0.484	-135.3	3.143	97.3	0.011	122.4	0.867	-69.8
2300.0000	0.484	-142.6	3.135	90.5	0.012	131.7	0.866	-72.3
2400.0000	0.490	-148.5	3.120	83.5	0.015	138.1	0.868	-75.5
2500.0000	0.499	-152.5	3.053	78.4	0.016	136.3	0.866	-78.7
2600.0000	0.499	-155.8	2.991	71.4	0.018	142.9	0.864	-82.5
2700.0000	0.485	-157.4	2.958	68.0	0.018	143.9	0.858	-86.6
2800.0000	0.464	-160.6	2.810	62.9	0.021	142.5	0.852	-89.7
2900.0000	0.439	-164.1	2.866	57.5	0.022	149.3	0.872	-93.4
3000.0000	0.416	-168.6	2.713	54.5	0.025	148.4	0.864	-96.6
3100.0000	0.403	-173.6	2.635	48.0	0.030	143.6	0.867	-101.0

-  $\mu$ PC8152TB -

CIRCUIT CURRENT vs. SUPPLY VOLTAGE

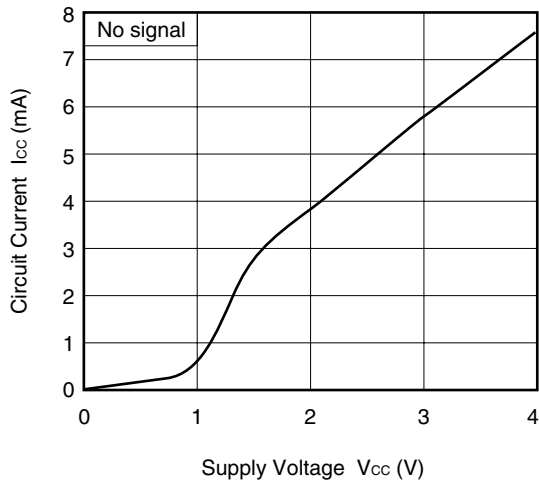

CIRCUIT CURRENT vs. OPERATING AMBIENT TEMPERATURE

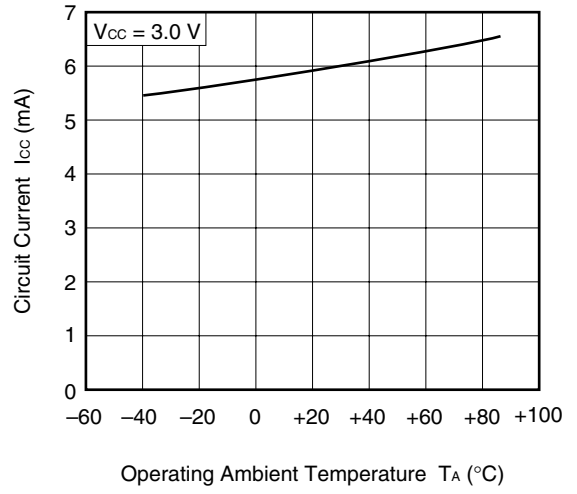

-  $\mu$ PC8152TB -

1.0 GHz output port matching

S-PARAMETERS (monitored at connector on board)

$T_A = +25^\circ\text{C}$ ,  $V_{CC} = V_{out} = 3.0\text{ V}$

S<sub>11</sub>  
 REF 1.0 Units  
 1 200.0 mUnits/  
 ▽ 51.59  $\Omega$  -20.508  $\Omega$

MARKER 1  
 1.0 GHz

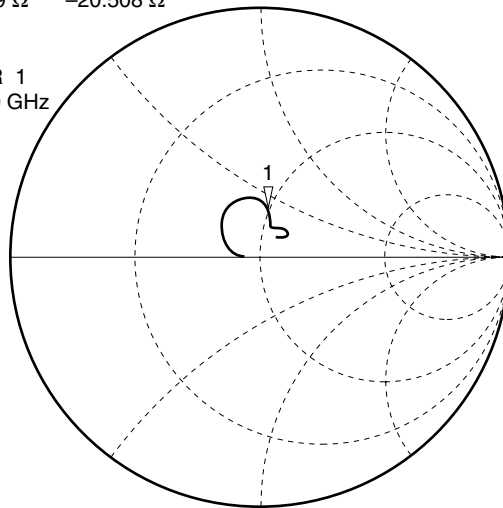

START 0.10000000 GHz  
 STOP 3.10000000 GHz

S<sub>22</sub>  
 REF 1.0 Units  
 1 200.0 mUnits/  
 ▽ 75.816  $\Omega$  -12.941  $\Omega$

MARKER 1  
 1.0 GHz

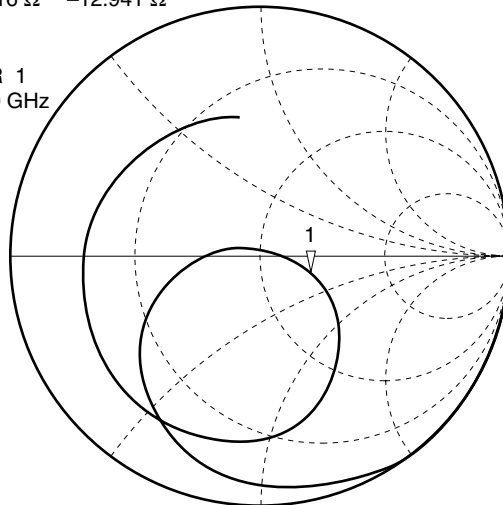

START 0.10000000 GHz  
 STOP 3.10000000 GHz



-  $\mu$ PC8152TB -

1.0 GHz output port matching

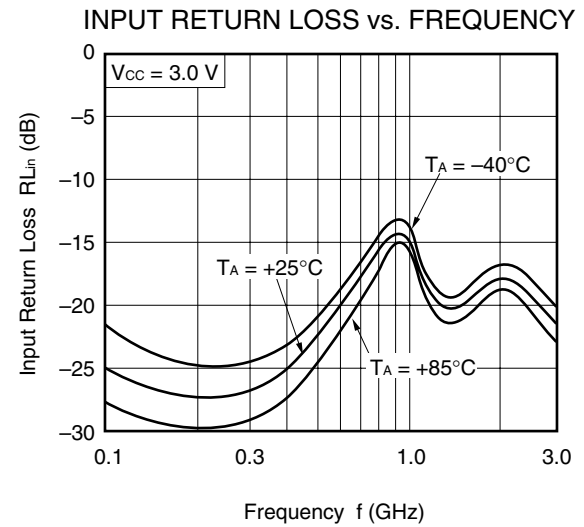
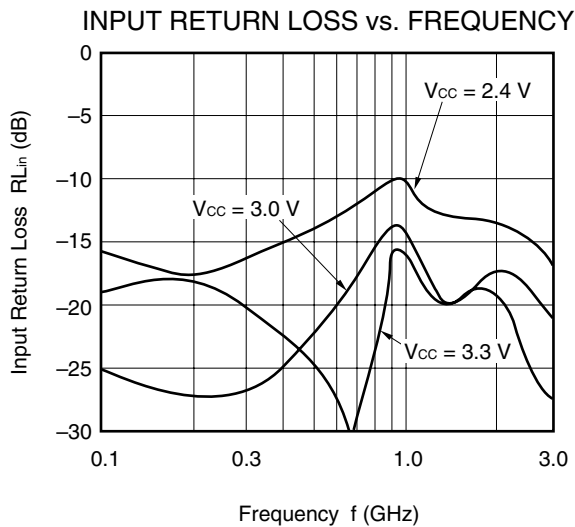
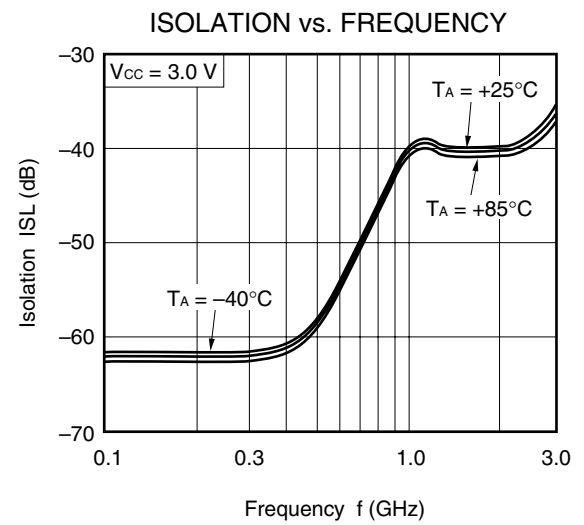
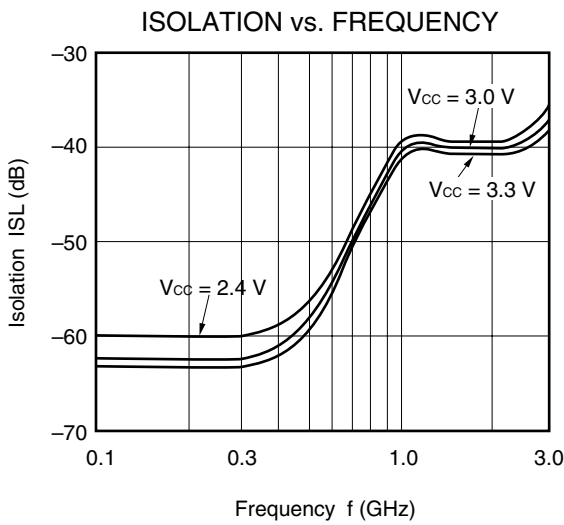
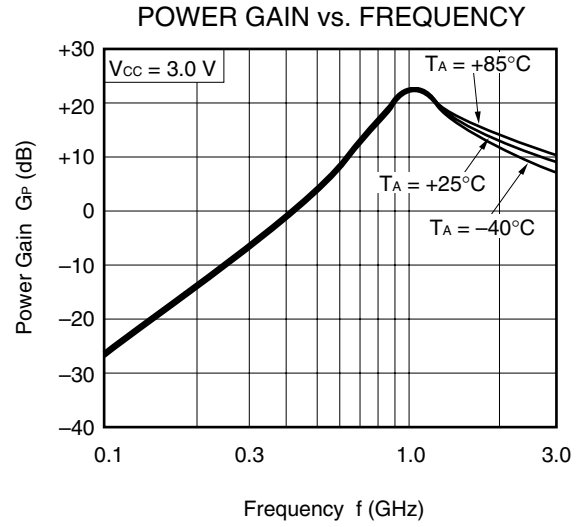
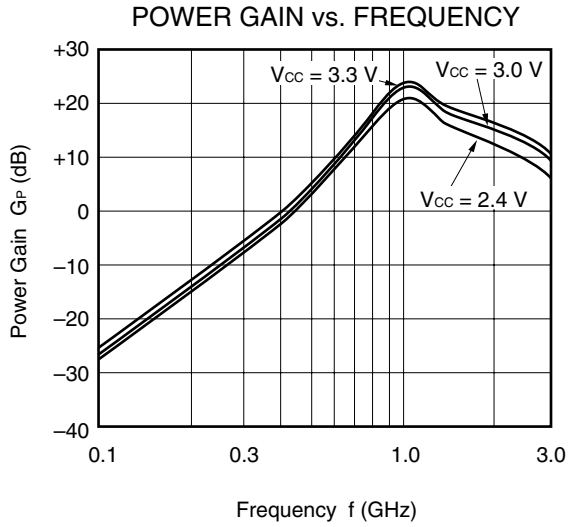

–  $\mu$ PC8152TB –

1.0 GHz output port matching

OUTPUT RETURN LOSS vs. FREQUENCY

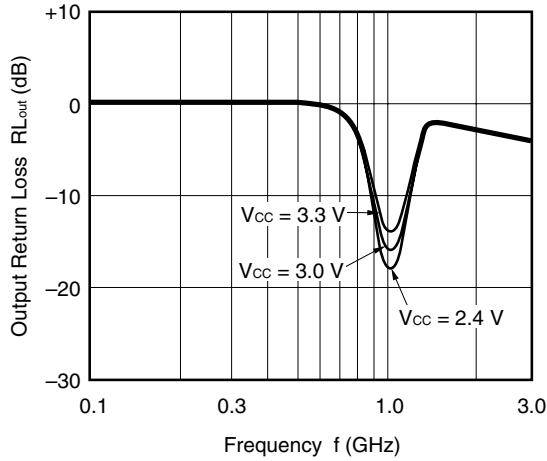

OUTPUT RETURN LOSS vs. FREQUENCY

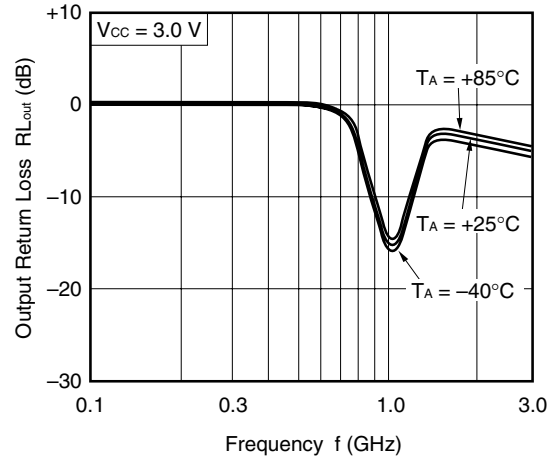

OUTPUT POWER vs. INPUT POWER

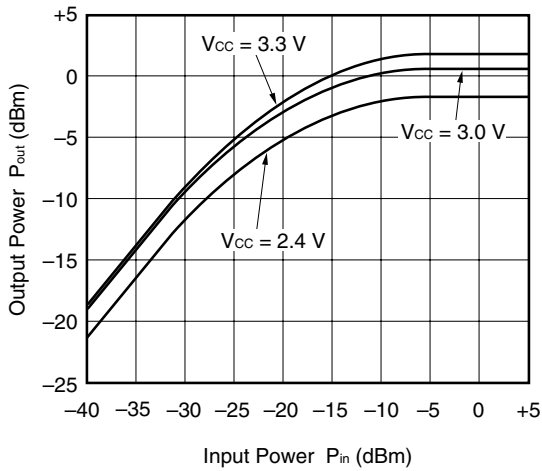

OUTPUT POWER vs. INPUT POWER

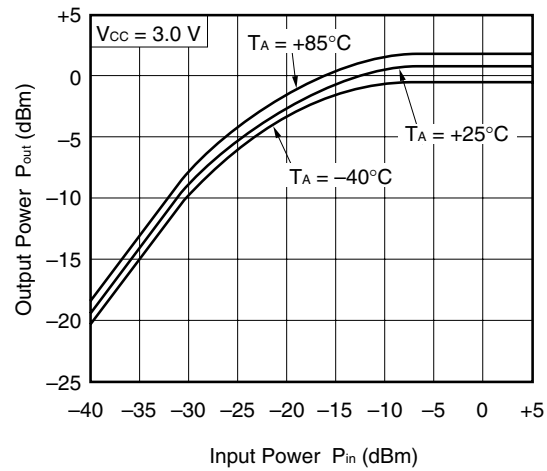

OUTPUT POWER OF EACH TONE, IM<sub>3</sub> vs. INPUT POWER OF EACH TONE

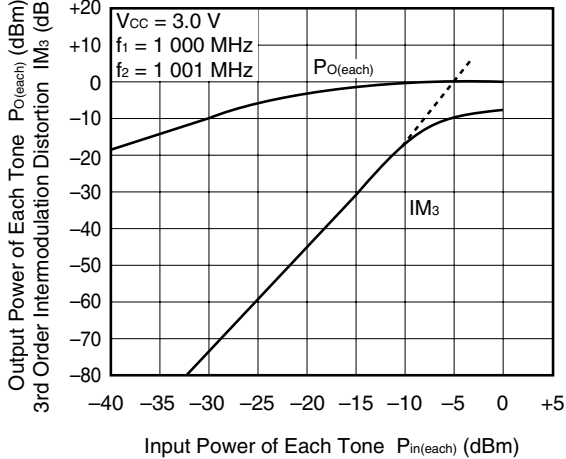

3RD ORDER INTERMODULATION DISTORTION vs. OUTPUT POWER OF EACH TONE

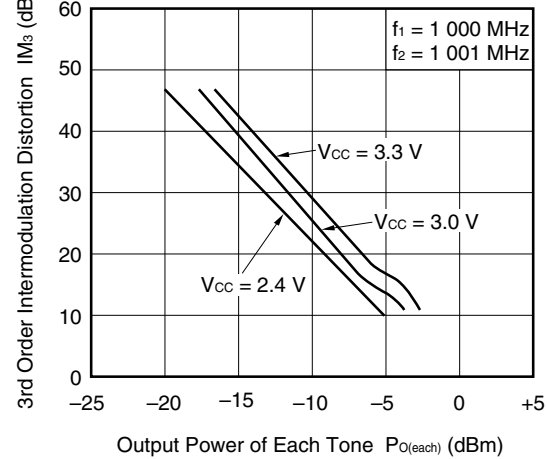

–  $\mu$ PC8152TB –

1.0 GHz output port matching

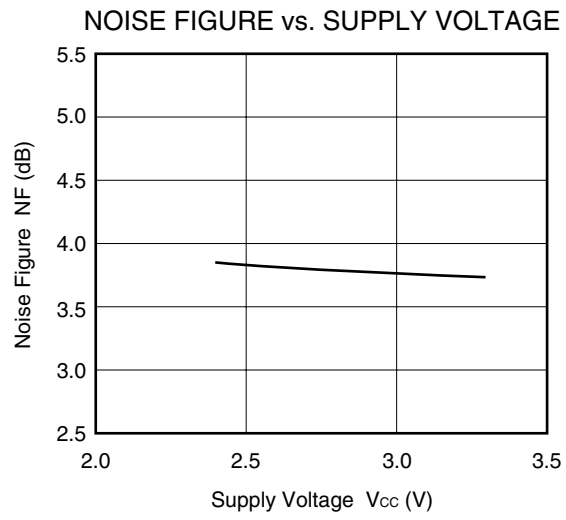

-  $\mu$ PC8152TB -

1.66 GHz output port matching

S-PARAMETERS (monitored at connector on board)

$T_A = +25^\circ\text{C}$ ,  $V_{CC} = V_{out} = 3.0\text{ V}$

S<sub>11</sub>  
 REF 1.0 Units  
 1 200.0 mUnits/  
 ▽ 98.301  $\Omega$  -25.836  $\Omega$

MARKER 1  
 1.66 GHz

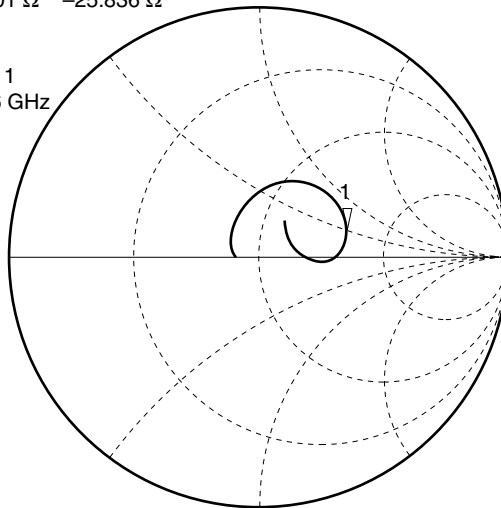

START 0.10000000 GHz  
 STOP 3.10000000 GHz

S<sub>22</sub>  
 REF 1.0 Units  
 1 200.0 mUnits/  
 ▽ 22.714  $\Omega$  10.238  $\Omega$

MARKER 1  
 1.66 GHz

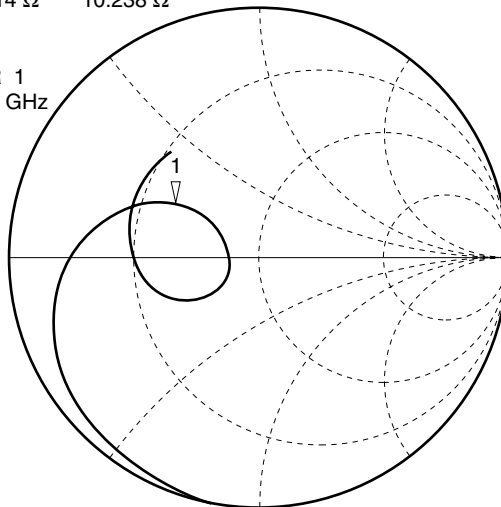

START 0.10000000 GHz  
 STOP 3.10000000 GHz

-  $\mu$ PC8152TB -

1.66 GHz output port matching

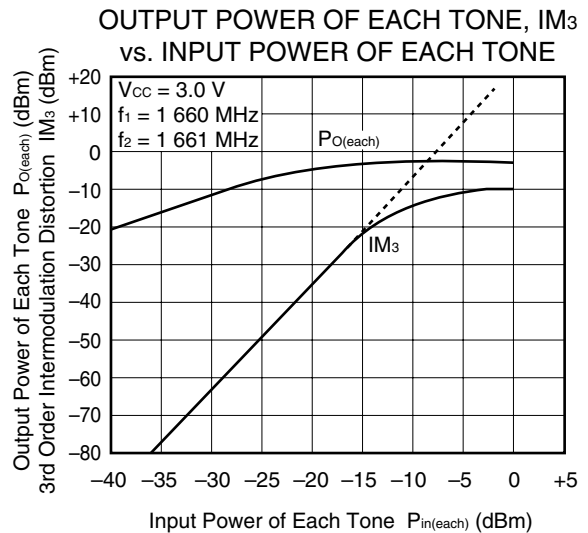
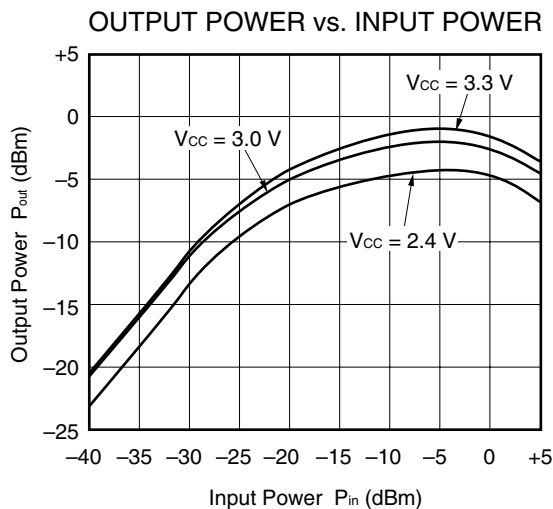
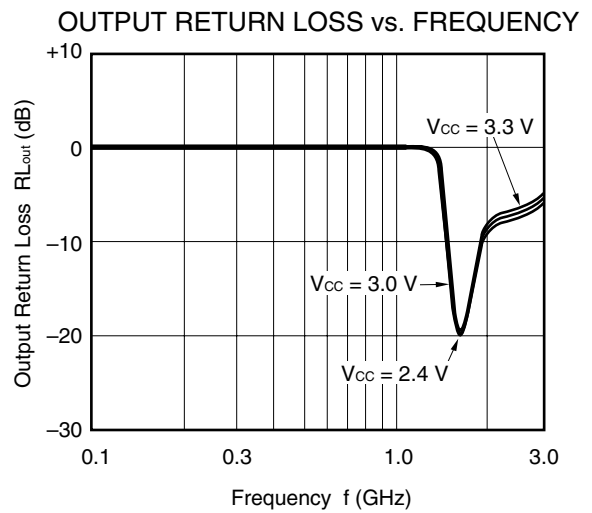
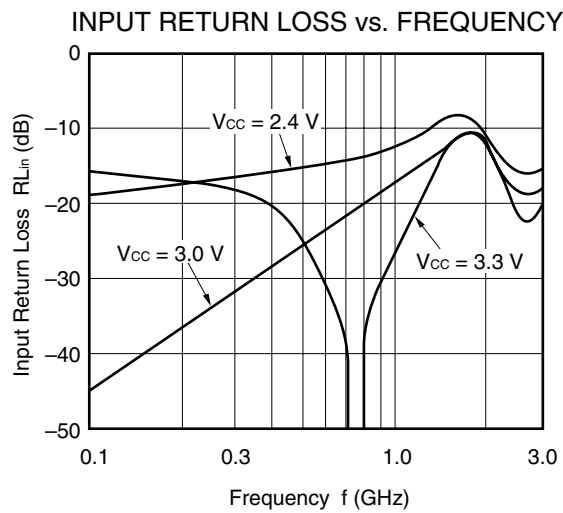
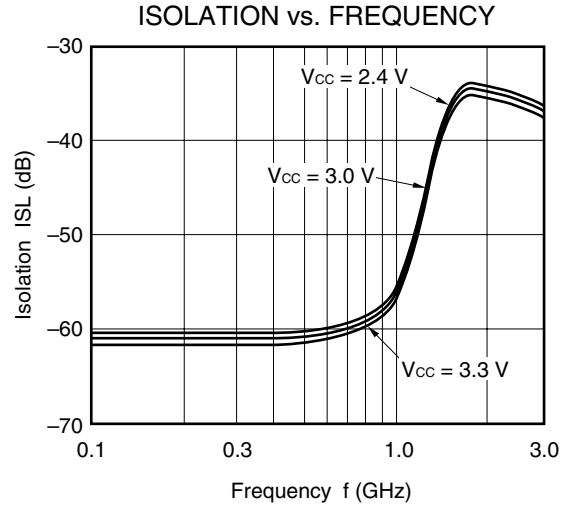
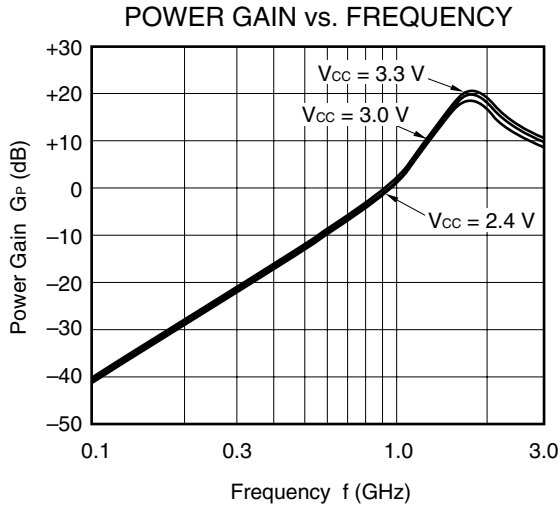

–  $\mu$ PC8152TB –

1.66 GHz output port matching

3RD ORDER INTERMODULATION DISTORTION vs. OUTPUT POWER OF EACH TONE

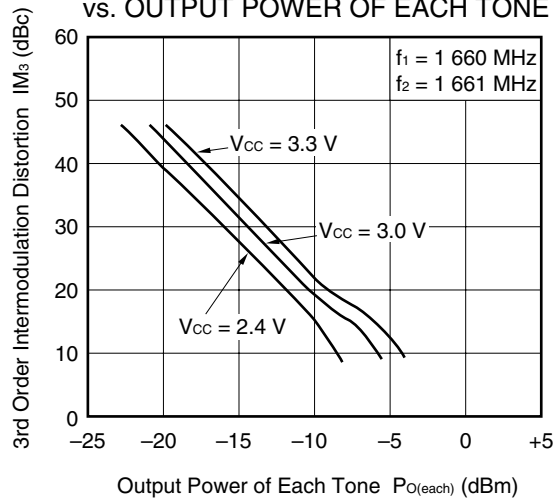

NOISE FIGURE vs. SUPPLY VOLTAGE

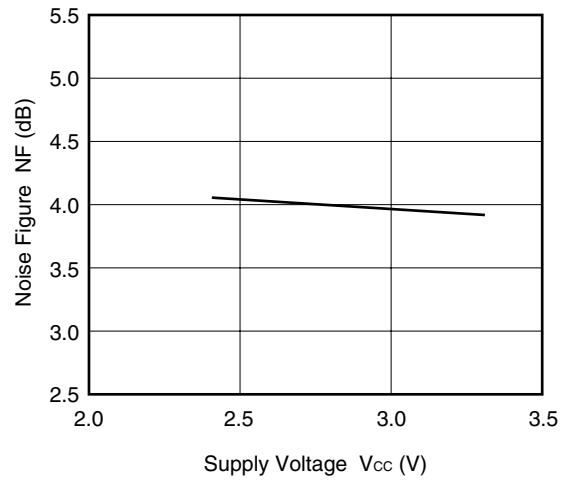

–  $\mu$ PC8152TB –

1.9 GHz output port matching

S-PARAMETERS (monitored at connector on board)

$T_A = +25^\circ\text{C}$ ,  $V_{CC} = V_{out} = 3.0\text{ V}$

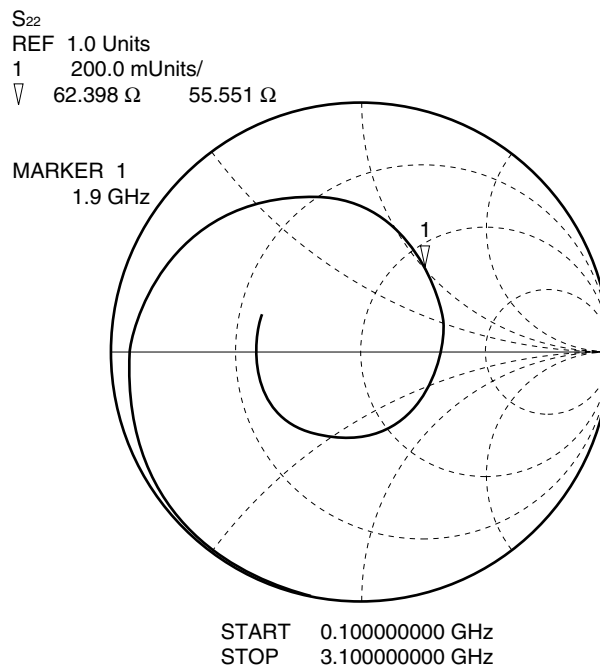
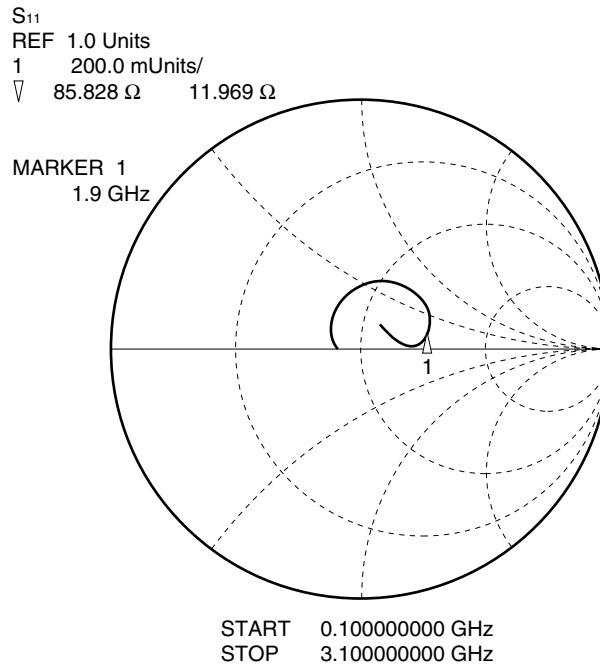

-  $\mu$ PC8152TB -

1.9 GHz output port matching

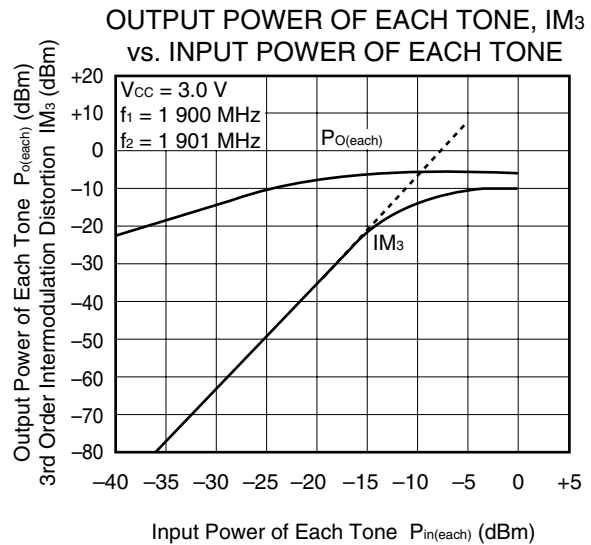
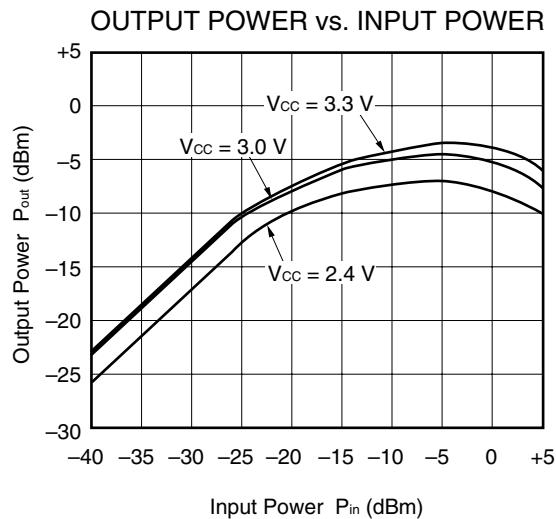
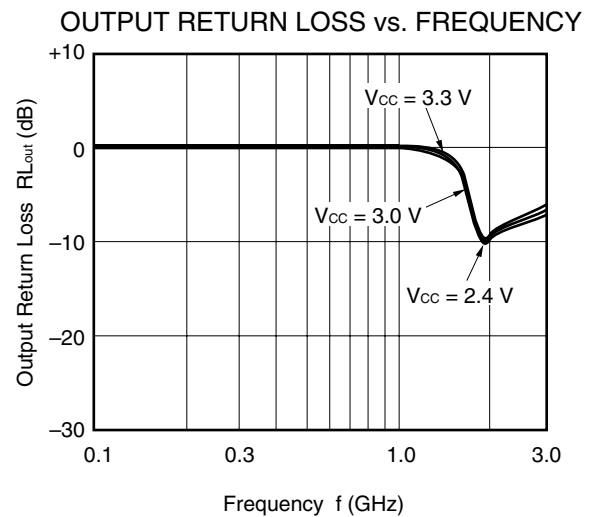
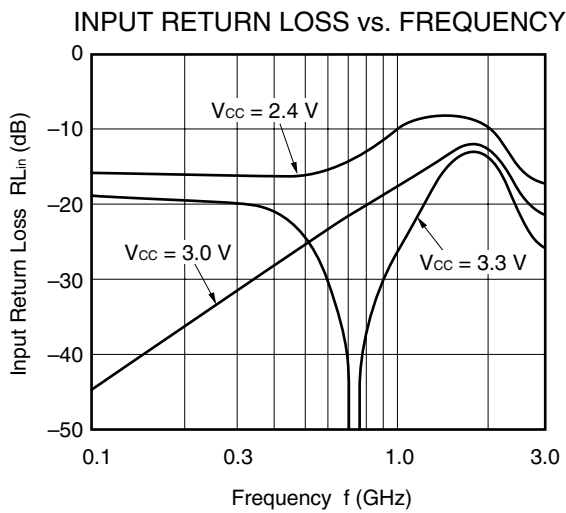
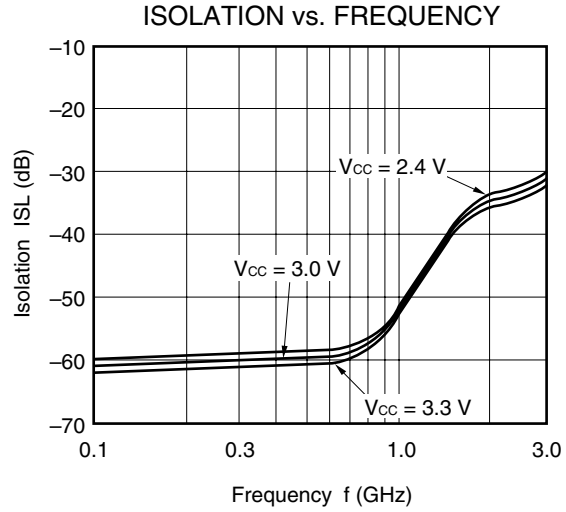
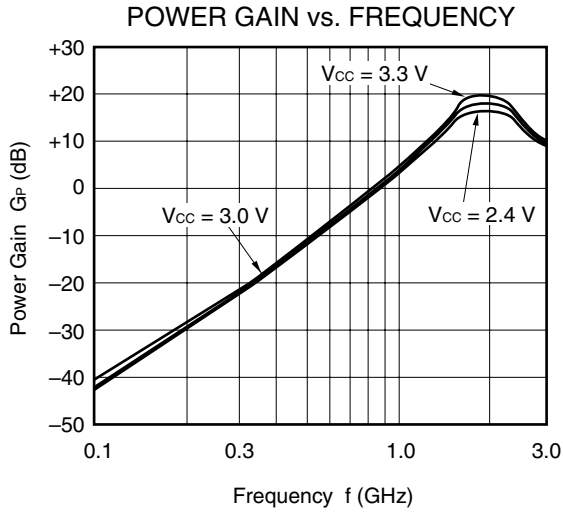



–  $\mu$ PC8152TB –

1.9 GHz output port matching

3RD ORDER INTERMODULATION DISTORTION vs. OUTPUT POWER OF EACH TONE

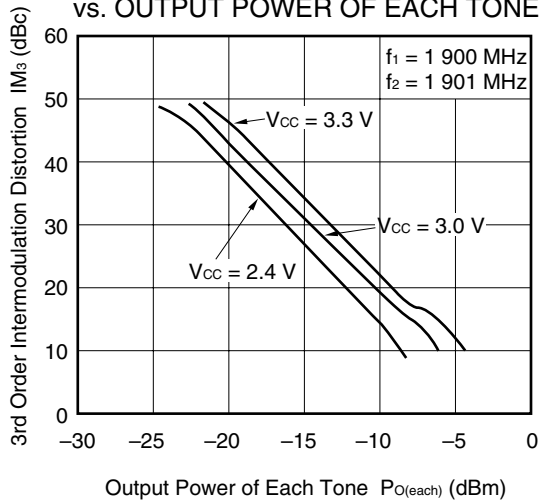

NOISE FIGURE vs. SUPPLY VOLTAGE

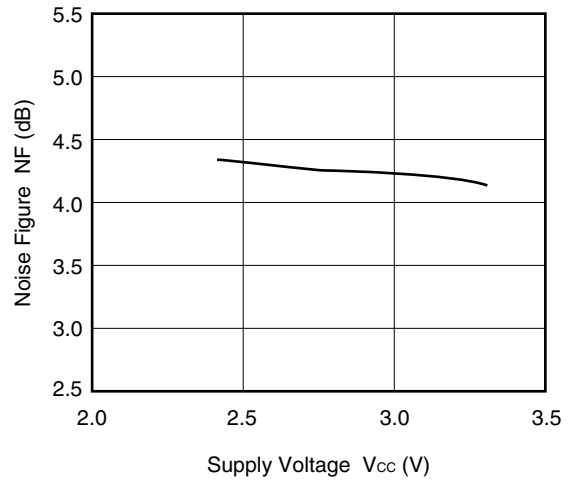

**Remark** The graphs indicate nominal characteristics.

S-PARAMETERS ( $T_A = +25^\circ\text{C}$ ,  $V_{CC} = V_{out} = 3.0\text{ V}$ )

–  $\mu$ PC8152TB –

S<sub>11</sub>–Frequency

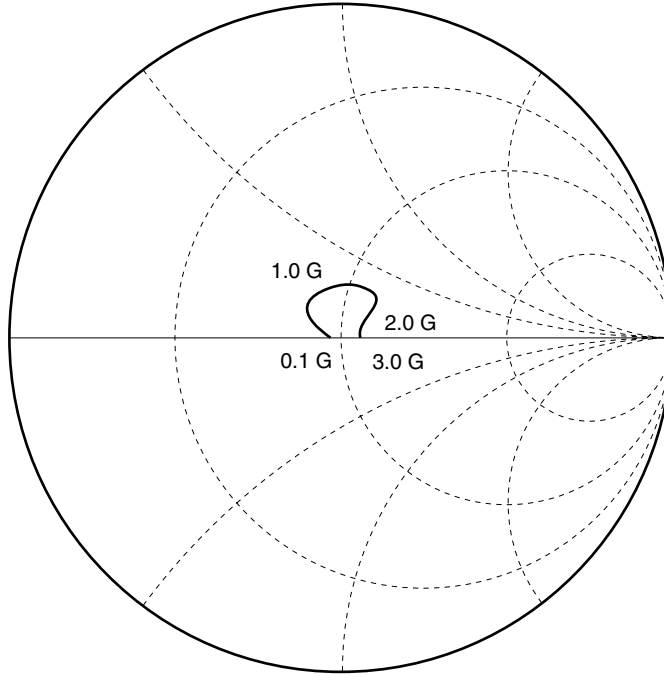

S<sub>22</sub>–Frequency

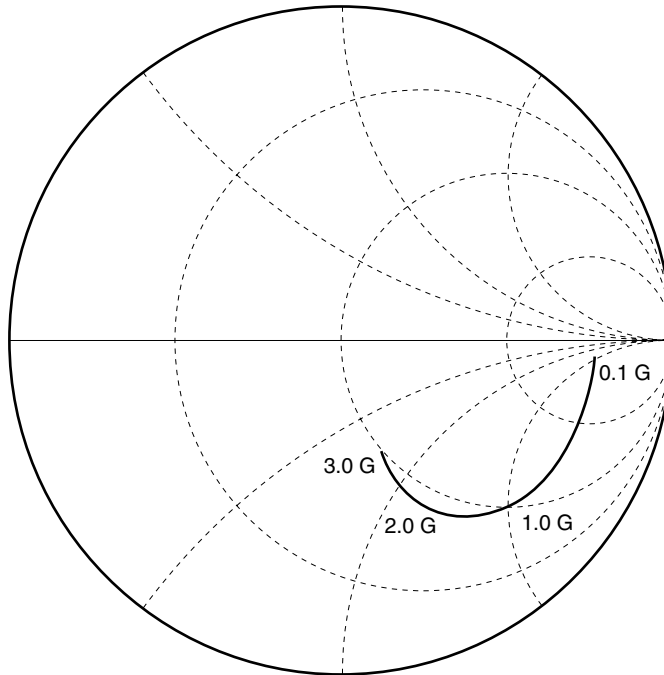

**TYPICAL S-PARAMETER VALUES (T<sub>A</sub> = +25°C)**

$\mu$ PC8152TB

V<sub>CC</sub> = V<sub>out</sub> = 3.0 V, I<sub>CC</sub> = 5.6 mA

FREQUENCY MHz	S <sub>11</sub>		S <sub>21</sub>		S <sub>12</sub>		S <sub>22</sub>	
	MAG.	ANG.	MAG.	ANG.	MAG.	ANG.	MAG.	ANG.
100.0000	0.062	168.0	6.691	-0.3	0.002	40.8	0.775	-3.3
200.0000	0.047	169.1	7.049	-3.7	0.001	101.6	0.773	-6.6
300.0000	0.055	166.9	7.418	-9.3	0.003	97.3	0.761	-9.1
400.0000	0.078	162.1	7.883	-16.0	0.003	70.7	0.759	-12.0
500.0000	0.101	155.6	8.311	-22.1	0.005	76.7	0.754	-15.3
600.0000	0.121	147.4	8.583	-29.7	0.004	80.5	0.754	-18.3
700.0000	0.135	141.2	9.093	-37.3	0.006	79.8	0.756	-21.3
800.0000	0.143	133.2	9.276	-45.4	0.005	85.9	0.755	-24.7
900.0000	0.146	122.4	9.572	-53.6	0.009	89.6	0.752	-28.1
1000.0000	0.146	108.9	9.763	-62.6	0.009	70.3	0.745	-32.0
1100.0000	0.153	97.4	9.851	-71.9	0.007	90.8	0.733	-36.3
1200.0000	0.157	82.7	9.926	-80.5	0.011	84.9	0.723	-40.3
1300.0000	0.164	73.3	9.816	-91.2	0.010	81.9	0.710	-44.3
1400.0000	0.168	63.4	9.586	-99.6	0.011	81.4	0.679	-48.5
1500.0000	0.171	56.1	9.332	-109.4	0.011	82.3	0.649	-52.0
1600.0000	0.165	47.2	9.128	-117.9	0.009	79.0	0.624	-56.3
1700.0000	0.164	38.7	8.544	-126.1	0.011	77.5	0.591	-59.2
1800.0000	0.156	30.2	8.152	-133.5	0.011	76.8	0.557	-61.4
1900.0000	0.158	25.1	7.607	-140.6	0.011	75.9	0.527	-63.4
2000.0000	0.148	21.5	7.264	-147.5	0.012	75.8	0.498	-65.6
2100.0000	0.140	19.1	6.759	-153.7	0.013	82.6	0.476	-66.8
2200.0000	0.124	21.6	6.366	-159.7	0.012	92.4	0.455	-67.1
2300.0000	0.104	19.3	6.028	-165.7	0.014	88.9	0.438	-68.1
2400.0000	0.085	17.8	5.642	-171.5	0.015	89.8	0.418	-68.1
2500.0000	0.068	10.9	5.200	-176.0	0.015	87.2	0.399	-69.5
2600.0000	0.059	9.9	4.874	179.1	0.016	94.2	0.390	-69.2
2700.0000	0.055	-0.1	4.527	175.9	0.017	93.5	0.380	-70.2
2800.0000	0.054	0.2	4.202	171.3	0.022	88.2	0.372	-70.3
2900.0000	0.054	1.9	4.005	167.7	0.021	91.4	0.369	-69.5
3000.0000	0.055	12.0	3.697	164.4	0.021	86.8	0.360	-69.6
3100.0000	0.057	22.3	3.502	160.4	0.023	83.9	0.352	-71.0

★ PACKAGE DIMENSIONS

6-PIN SUPER MINIMOLD (UNIT: mm)

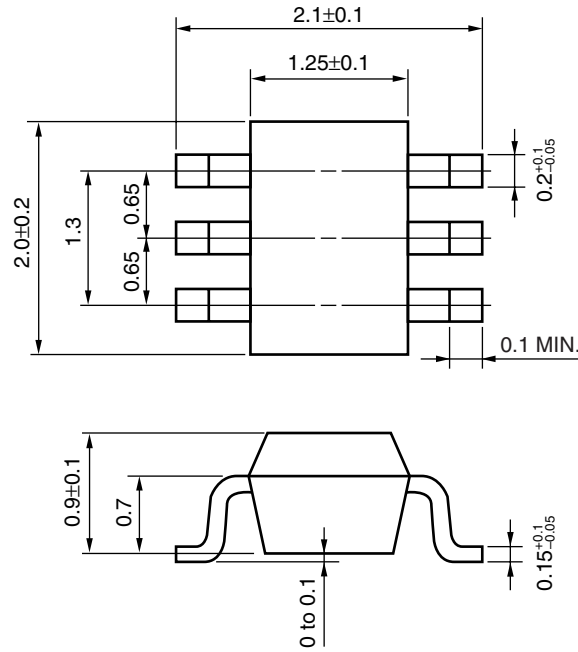

**NOTES ON CORRECT USE**

- (1) Observe precautions for handling because of electro-static sensitive devices.
- (2) Form a ground pattern as widely as possible to minimize ground impedance (to prevent undesired oscillation).  
All the ground pins must be connected together with wide ground pattern to decrease impedance difference.
- (3) The bypass capacitor should be attached to V<sub>CC</sub> line.
- (4) The inductor (L) should be attached between output and V<sub>CC</sub> pins. The L and series capacitor (C2) values should be adjusted for applied frequency to match impedance to next stage.
- (5) The DC capacitor must be attached to input pin.

**RECOMMENDED SOLDERING CONDITIONS**

This product should be soldered under the following recommended conditions. For soldering methods and conditions other than those recommended below, contact your NEC sales representative.

Soldering Method	Soldering Conditions	Recommended Condition Symbol
Infrared Reflow	Package peak temperature: 235°C or below Time: 30 seconds or less (at 210°C) Count: 3, Exposure limit: None <sup>Note</sup>	IR35-00-3
VPS	Package peak temperature: 215°C or below Time: 40 seconds or less (at 200°C) Count: 3, Exposure limit: None <sup>Note</sup>	VP15-00-3
Wave Soldering	Soldering bath temperature: 260°C or below Time: 10 seconds or less Count: 1, Exposure limit: None <sup>Note</sup>	WS60-00-1
Partial Heating	Pin temperature: 300°C or below Time: 3 seconds or less (per side of device) Exposure limit: None <sup>Note</sup>	—

**Note** After opening the dry pack, keep it in a place below 25°C and 65% RH for the allowable storage period.

**Caution** Do not use different soldering methods together (except for partial heating).

For details of recommended soldering conditions for surface mounting, refer to information document SEMICONDUCTOR DEVICE MOUNTING TECHNOLOGY MANUAL (C10535E).

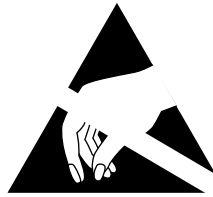

## ATTENTION

OBSERVE PRECAUTIONS  
FOR HANDLING  
ELECTROSTATIC  
SENSITIVE  
DEVICES

**NESAT (NEC Silicon Advanced Technology) is a trademark of NEC Corporation.**

- **The information in this document is current as of February, 2001. The information is subject to change without notice. For actual design-in, refer to the latest publications of NEC's data sheets or data books, etc., for the most up-to-date specifications of NEC semiconductor products. Not all products and/or types are available in every country. Please check with an NEC sales representative for availability and additional information.**
- No part of this document may be copied or reproduced in any form or by any means without prior written consent of NEC. NEC assumes no responsibility for any errors that may appear in this document.
- NEC does not assume any liability for infringement of patents, copyrights or other intellectual property rights of third parties by or arising from the use of NEC semiconductor products listed in this document or any other liability arising from the use of such products. No license, express, implied or otherwise, is granted under any patents, copyrights or other intellectual property rights of NEC or others.
- Descriptions of circuits, software and other related information in this document are provided for illustrative purposes in semiconductor product operation and application examples. The incorporation of these circuits, software and information in the design of customer's equipment shall be done under the full responsibility of customer. NEC assumes no responsibility for any losses incurred by customers or third parties arising from the use of these circuits, software and information.
- While NEC endeavours to enhance the quality, reliability and safety of NEC semiconductor products, customers agree and acknowledge that the possibility of defects thereof cannot be eliminated entirely. To minimize risks of damage to property or injury (including death) to persons arising from defects in NEC semiconductor products, customers must incorporate sufficient safety measures in their design, such as redundancy, fire-containment, and anti-failure features.
- NEC semiconductor products are classified into the following three quality grades:  
"Standard", "Special" and "Specific". The "Specific" quality grade applies only to semiconductor products developed based on a customer-designated "quality assurance program" for a specific application. The recommended applications of a semiconductor product depend on its quality grade, as indicated below. Customers must check the quality grade of each semiconductor product before using it in a particular application.
  - "Standard": Computers, office equipment, communications equipment, test and measurement equipment, audio and visual equipment, home electronic appliances, machine tools, personal electronic equipment and industrial robots
  - "Special": Transportation equipment (automobiles, trains, ships, etc.), traffic control systems, anti-disaster systems, anti-crime systems, safety equipment and medical equipment (not specifically designed for life support)
  - "Specific": Aircraft, aerospace equipment, submersible repeaters, nuclear reactor control systems, life support systems and medical equipment for life support, etc.

The quality grade of NEC semiconductor products is "Standard" unless otherwise expressly specified in NEC's data sheets or data books, etc. If customers wish to use NEC semiconductor products in applications not intended by NEC, they must contact an NEC sales representative in advance to determine NEC's willingness to support a given application.

(Note)

- (1) "NEC" as used in this statement means NEC Corporation and also includes its majority-owned subsidiaries.
- (2) "NEC semiconductor products" means any semiconductor product developed or manufactured by or for NEC (as defined above).