



# BIPOLAR ANALOG INTEGRATED CIRCUIT

# UPC3226TB

## 5 V, SILICON GERMANIUM MMIC MEDIUM OUTPUT POWER AMPLIFIER

### DESCRIPTION

The  $\mu$ PC3226TB is a silicon germanium (SiGe) monolithic integrated circuit designed as IF amplifier for DBS tuners. This IC is manufactured using our 50 GHz  $f_{\max}$  UHS2 (Ultra High Speed Process) SiGe bipolar process.

### FEATURES

- Low current :  $I_{CC} = 15.5$  mA TYP. @  $V_{CC} = 5.0$  V
- Medium output power :  $P_{O(sat)} = +13.0$  dBm TYP. @  $f = 1.0$  GHz  
:  $P_{O(sat)} = +9.0$  dBm TYP. @  $f = 2.2$  GHz
- High linearity :  $P_{O(1dB)} = +7.5$  dBm TYP. @  $f = 1.0$  GHz  
:  $P_{O(1dB)} = +5.7$  dBm TYP. @  $f = 2.2$  GHz
- Power gain :  $G_P = 25.0$  dB TYP. @  $f = 1.0$  GHz  
:  $G_P = 26.0$  dB TYP. @  $f = 2.2$  GHz
- Noise Figure :  $NF = 5.3$  dB TYP. @  $f = 1.0$  GHz  
:  $NF = 4.9$  dB TYP. @  $f = 2.2$  GHz
- Supply voltage :  $V_{CC} = 4.5$  to  $5.5$  V
- Port impedance : input/output  $50 \Omega$

### APPLICATIONS

- IF amplifiers in LNB for DBS converters etc.

### ORDERING INFORMATION

Part Number	Order Number	Package	Marking	Supplying Form
$\mu$ PC3226TB-E3	$\mu$ PC3226TB-E3-A	6-pin super minimold (Pb-Free) <sup>Note</sup>	C3N	Embossed tape 8 mm wide. 1, 2, 3 pins face the perforation side of the tape. Qty 3 kpcs/reel.

**Note** With regards to terminal solder (the solder contains lead) plated products (conventionally plated), contact your nearby sales office.

**Remark** To order evaluation samples, please contact your nearby sales office  
Part number for sample order:  $\mu$ PC3226TB

**Caution** Observe precautions when handling because these devices are sensitive to electrostatic discharge.

The information in this document is subject to change without notice. Before using this document, please confirm that this is the latest version.

**PIN CONNECTIONS**

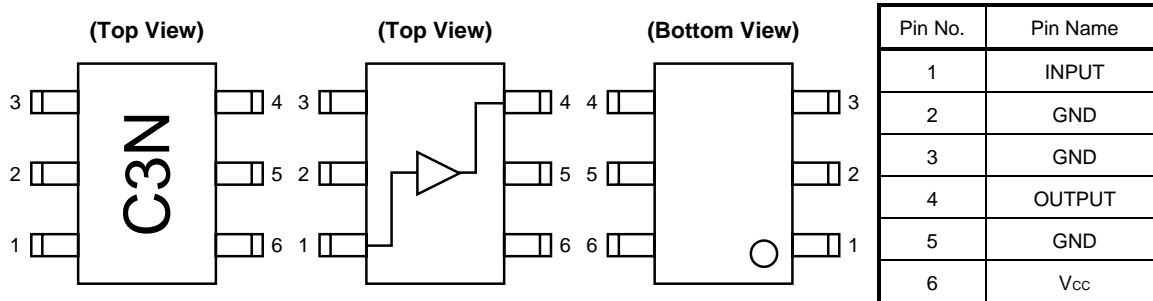

**PRODUCT LINE-UP OF 5 V-BIAS SILICON MMIC MEDIUM OUTPUT POWER AMPLIFIER**  
 (T<sub>A</sub> = +25°C, f = 1 GHz, V<sub>cc</sub> = V<sub>out</sub> = 5.0 V, Z<sub>s</sub> = Z<sub>L</sub> = 50 Ω)

Part No.	f <sub>u</sub> (GHz)	P <sub>O (sat)</sub> (dBm)	G <sub>P</sub> (dB)	NF (dB)	I <sub>cc</sub> (mA)	Package	Marking
μPC2708TB	2.9	+10.0	15	6.5	26	6-pin super minimold	C1D
μPC2709TB	2.3	+11.5	23	5.0	25		C1E
μPC2710TB	1.0	+13.5	33	3.5	22		C1F
μPC2776TB	2.7	+8.5	23	6.0	25		C2L
μPC3223TB	3.2	+12.0	23	4.5	19		C3J
μPC3225TB	2.8	+15.5 <sup>Note</sup>	32.5 <sup>Note</sup>	3.7 <sup>Note</sup>	24.5		C3M
μPC3226TB	3.2	+13.0	25	5.3	15.5		C3N

**Note** μPC3225TB is f = 0.95 GHz

**Remark** Typical performance. Please refer to **ELECTRICAL CHARACTERISTICS** in detail.

**ABSOLUTE MAXIMUM RATINGS**

Parameter	Symbol	Conditions	Ratings	Unit
Supply Voltage	V <sub>CC</sub>	T <sub>A</sub> = +25°C	6.0	V
Total Circuit Current	I <sub>CC</sub>	T <sub>A</sub> = +25°C	40	mA
Power Dissipation	P <sub>D</sub>	T <sub>A</sub> = +85°C <b>Note</b>	270	mW
Operating Ambient Temperature	T <sub>A</sub>		-40 to +85	°C
Storage Temperature	T <sub>stg</sub>		-55 to +150	°C
Input Power	P <sub>in</sub>	T <sub>A</sub> = +25°C	+10	dBm

**Note** Mounted on double-sided copper-clad 50 × 50 × 1.6 mm epoxy glass PWB

**RECOMMENDED OPERATING RANGE**

Parameter	Symbol	Conditions	MIN.	TYP.	MAX.	Unit
Supply Voltage	V <sub>CC</sub>		4.5	5.0	5.5	V
Operating Ambient Temperature	T <sub>A</sub>		-40	+25	+85	°C

**ELECTRICAL CHARACTERISTICS (T<sub>A</sub> = +25°C, V<sub>CC</sub> = V<sub>out</sub> = 5.0 V, Z<sub>s</sub> = Z<sub>L</sub> = 50 Ω)**

Parameter	Symbol	Test Conditions	MIN.	TYP.	MAX.	Unit
Circuit Current	I <sub>CC</sub>	No input signal	12.5	15.5	19.5	mA
Power Gain 1	G <sub>P1</sub>	f = 0.1 GHz, P <sub>in</sub> = -30 dBm	22.0	24.0	26.0	dB
Power Gain 2	G <sub>P2</sub>	f = 1.0 GHz, P <sub>in</sub> = -30 dBm	23.0	25.0	27.5	
Power Gain 3	G <sub>P3</sub>	f = 1.8 GHz, P <sub>in</sub> = -30 dBm	23.0	26.0	29.0	
Power Gain 4	G <sub>P4</sub>	f = 2.2 GHz, P <sub>in</sub> = -30 dBm	23.0	26.0	29.0	
Power Gain 5	G <sub>P5</sub>	f = 2.6 GHz, P <sub>in</sub> = -30 dBm	22.5	25.5	29.0	
Power Gain 6	G <sub>P6</sub>	f = 3.0 GHz, P <sub>in</sub> = -30 dBm	22.0	25.0	28.5	
Saturated Output Power 1	P <sub>O (sat) 1</sub>	f = 1.0 GHz, P <sub>in</sub> = -2 dBm	+10.0	+13.0	-	dBm
Saturated Output Power 2	P <sub>O (sat) 2</sub>	f = 2.2 GHz, P <sub>in</sub> = -8 dBm	+6.0	+9.0	-	
Gain 1 dB Compression Output Power 1	P <sub>O (1 dB) 1</sub>	f = 1.0 GHz	+5.0	+7.5	-	dBm
Gain 1 dB Compression Output Power 2	P <sub>O (1 dB) 2</sub>	f = 2.2 GHz	+3.0	+5.7	-	
Noise Figure 1	NF1	f = 1.0 GHz	-	5.3	6.0	dB
Noise Figure 2	NF2	f = 2.2 GHz	-	4.9	6.0	
Isolation 1	ISL1	f = 1.0 GHz, P <sub>in</sub> = -30 dBm	31	34	-	dB
Isolation 2	ISL2	f = 2.2 GHz, P <sub>in</sub> = -30 dBm	33	36	-	
Input Return Loss 1	RL <sub>in1</sub>	f = 1.0 GHz, P <sub>in</sub> = -30 dBm	10.0	14.0	-	dB
Input Return Loss 2	RL <sub>in2</sub>	f = 2.2 GHz, P <sub>in</sub> = -30 dBm	9.0	13.0	-	
Output Return Loss 1	RL <sub>out1</sub>	f = 1.0 GHz, P <sub>in</sub> = -30 dBm	10.0	13.0	-	dB
Output Return Loss 2	RL <sub>out2</sub>	f = 2.2 GHz, P <sub>in</sub> = -30 dBm	10.0	13.0	-	
Input 3rd Order Distortion Intercept Point 1	IIP <sub>31</sub>	f1 = 1 000 MHz, f2 = 1 001 MHz, P <sub>in</sub> = -30 dBm	-	-5.0	-	dBm
Input 3rd Order Distortion Intercept Point 2	IIP <sub>32</sub>	f1 = 2 200 MHz, f2 = 2 201 MHz, P <sub>in</sub> = -30 dBm	-	-11.0	-	
Output 3rd Order Distortion Intercept Point 1	OIP <sub>31</sub>	f1 = 1 000 MHz, f2 = 1 001 MHz, P <sub>in</sub> = -30 dBm	-	+20.0	-	dBm
Output 3rd Order Distortion Intercept Point 2	OIP <sub>32</sub>	f1 = 2 200 MHz, f2 = 2 201 MHz, P <sub>in</sub> = -30 dBm	-	+15.0	-	
2nd Order Intermodulation Distortion	IM <sub>2</sub>	f1 = 1 000 MHz, f2 = 1 001 MHz, P <sub>in</sub> = -30 dBm	-	43.0	-	dBc
K factor 1	K1	f = 1.0 GHz	-	1.4	-	-
K factor 2	K2	f = 2.2 GHz	-	1.6	-	-

**TEST CIRCUIT**

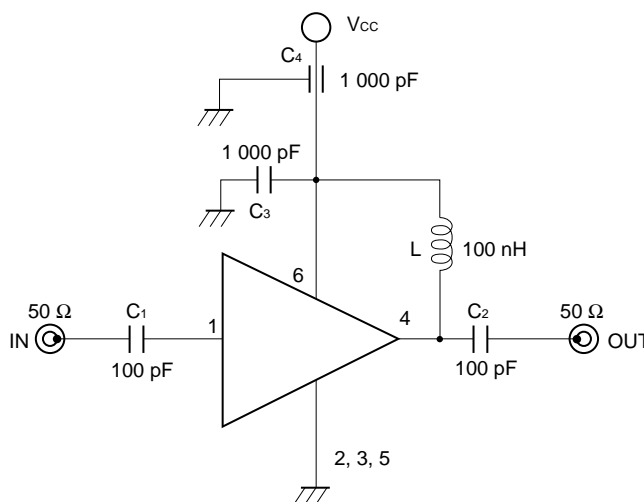

The application circuits and their parameters are for reference only and are not intended for use in actual design-ins.

**COMPONENTS OF TEST CIRCUIT FOR MEASURING ELECTRICAL CHARACTERISTICS**

	Type	Value
C1, C2	Chip Capacitor	100 pF
C3	Chip Capacitor	1 000 pF
C4	Feed-through Capacitor	1 000 pF
L	Chip Inductor	100 nH

**INDUCTOR FOR THE OUTPUT PIN**

The internal output transistor of this IC, to output medium power. To supply current for output transistor, connect an inductor between the Vcc pin (pin 6) and output pin (pin 4). Select inductance, as the value listed above.

The inductor has both DC and AC effects. In terms of DC, the inductor biases the output transistor with minimum voltage drop to output enable high level. In terms of AC, the inductor makes output-port impedance higher to get enough gain. In this case, large inductance and Q is suitable.

**CAPACITORS FOR THE Vcc, INPUT AND OUTPUT PINS**

Capacitors of 1 000 pF are recommendable as the bypass capacitor for the Vcc pin and the coupling capacitors for the input and output pins.

The bypass capacitor connected to the Vcc pin is used to minimize ground impedance of Vcc pin. So, stable bias can be supplied against Vcc fluctuation.

The coupling capacitors, connected to the input and output pins, are used to cut the DC and minimize RF serial impedance. Their capacitances are therefore selected as lower impedance against a 50 ohm load. The capacitors thus perform as high pass filters, suppressing low frequencies to DC.

To obtain a flat gain from 100 MHz upwards, 1 000 pF capacitors are used in the test circuit. In the case of under 10 MHz operation, increase the value of coupling capacitor such as 10 000 pF. Because the coupling capacitors are determined by equation,  $C = 1/(2 \pi Rfc)$ .

ILLUSTRATION OF THE TEST CIRCUIT ASSEMBLED ON EVALUATION BOARD

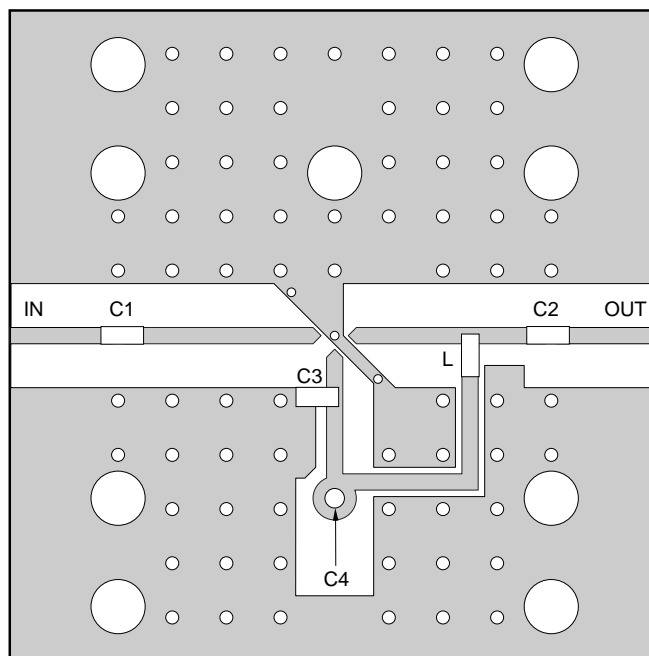

COMPONENT LIST

	Value
C1, C2	100 pF
C3, C4	1 000 pF
L1	100 nH

Notes

1. 30 × 30 × 0.4 mm double sided copper clad polyimide board.
2. Back side: GND pattern
3. Solder plated on pattern
4. ○○: Through holes

TYPICAL CHARACTERISTICS ( $T_A = +25^\circ\text{C}$ ,  $V_{CC} = V_{out} = 5.0\text{ V}$ ,  $Z_s = Z_L = 50\ \Omega$ , unless otherwise specified)

CIRCUIT CURRENT vs. SUPPLY VOLTAGE

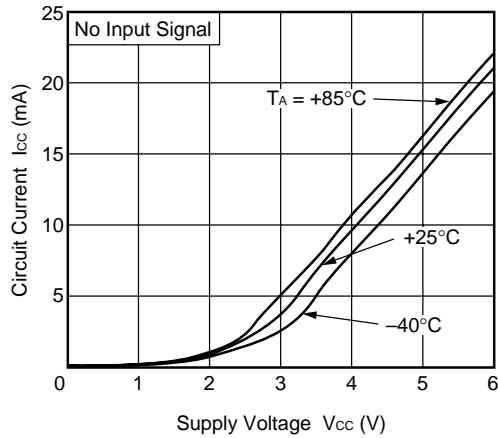

CIRCUIT CURRENT vs. OPERATING AMBIENT TEMPERATURE

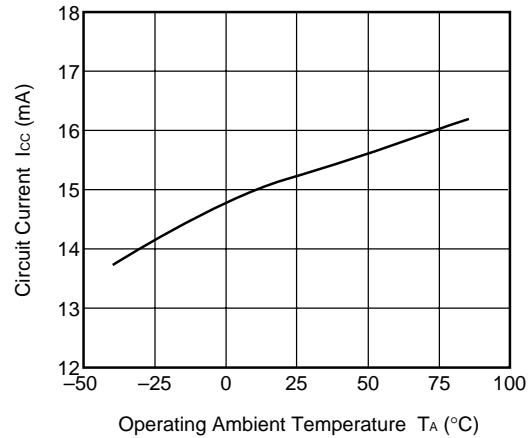

POWER GAIN vs. FREQUENCY

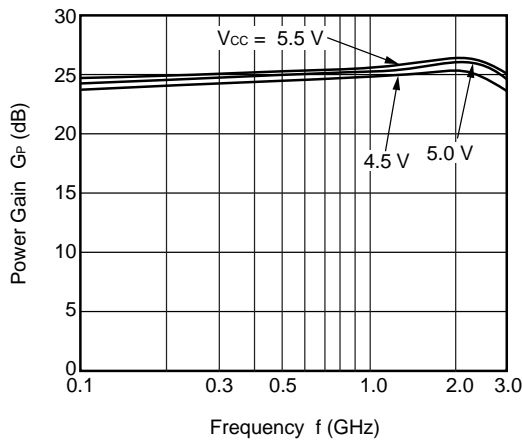

ISOLATION vs. FREQUENCY

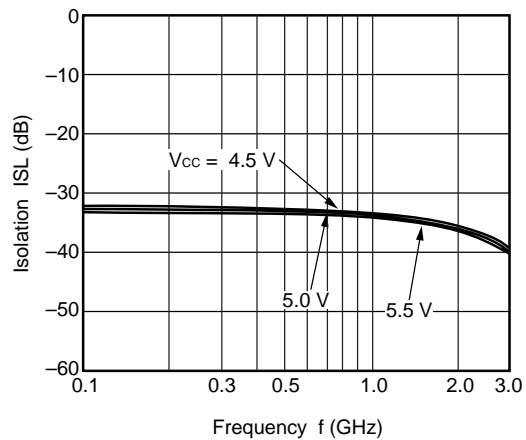

INPUT RETURN LOSS vs. FREQUENCY

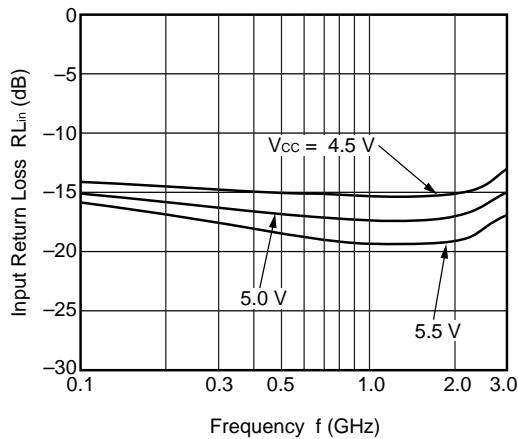

OUTPUT RETURN LOSS vs. FREQUENCY

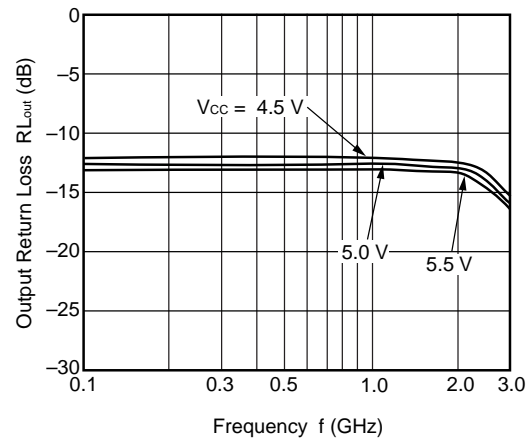

**Remark** The graphs indicate nominal characteristics.

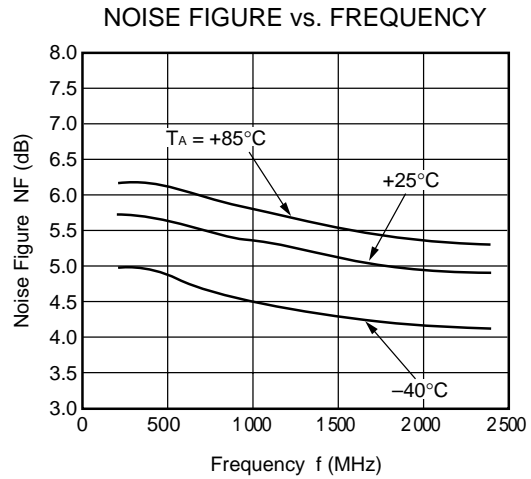
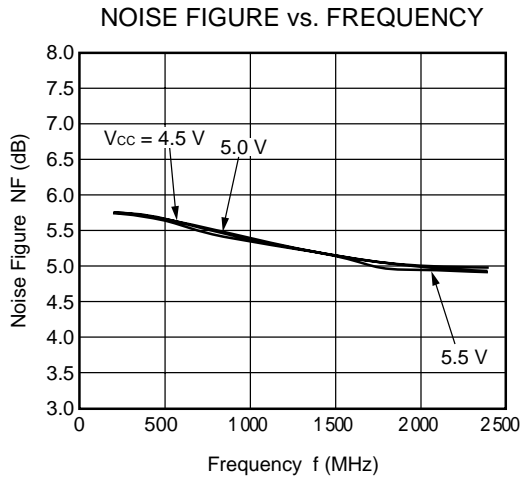
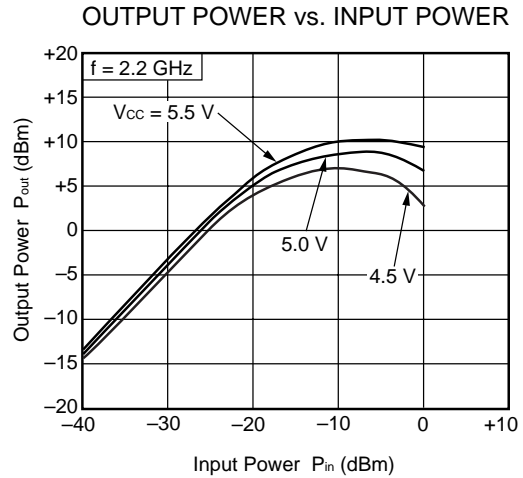
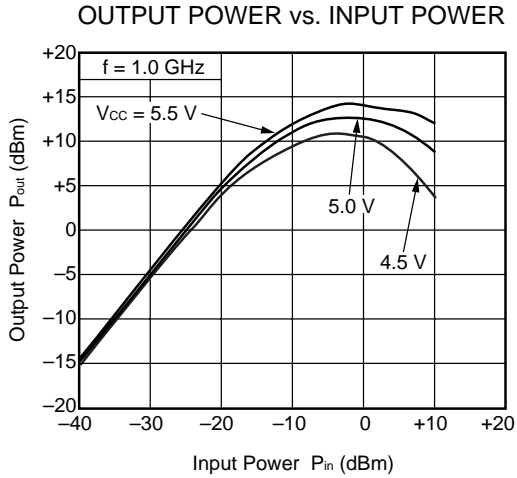

**Remark** The graphs indicate nominal characteristics.



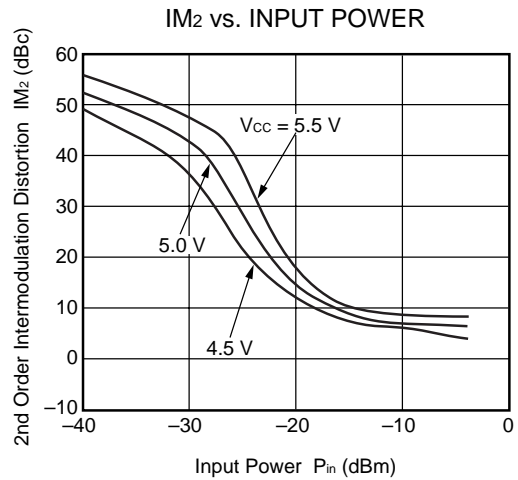
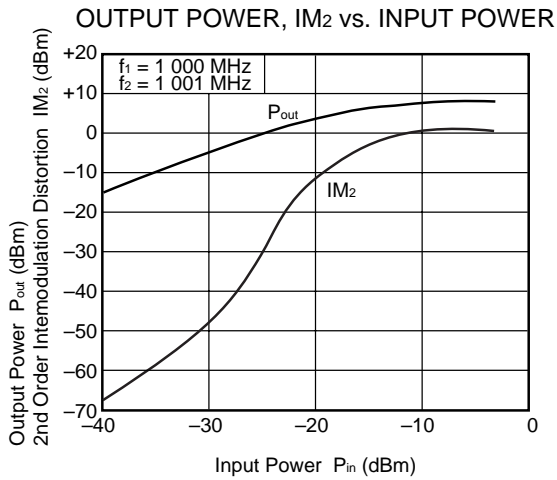
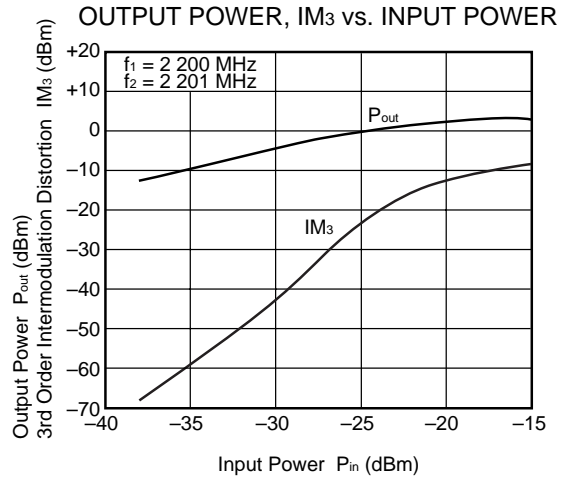
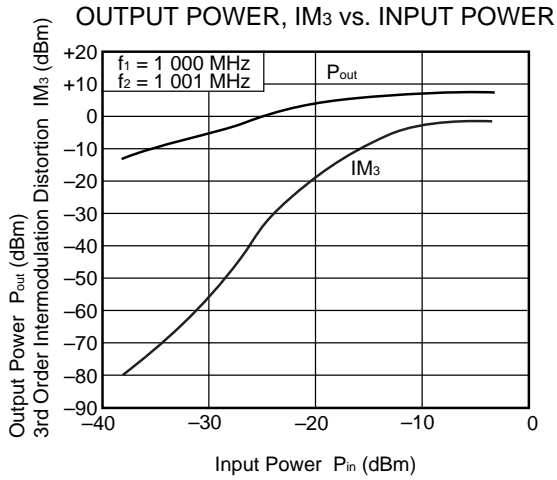

**Remark** The graphs indicate nominal characteristics.

S-PARAMETERS (T<sub>A</sub> = +25°C, V<sub>CC</sub> = V<sub>out</sub> = 5.0 V, P<sub>in</sub> = -30 dBm)

S<sub>11</sub>-FREQUENCY

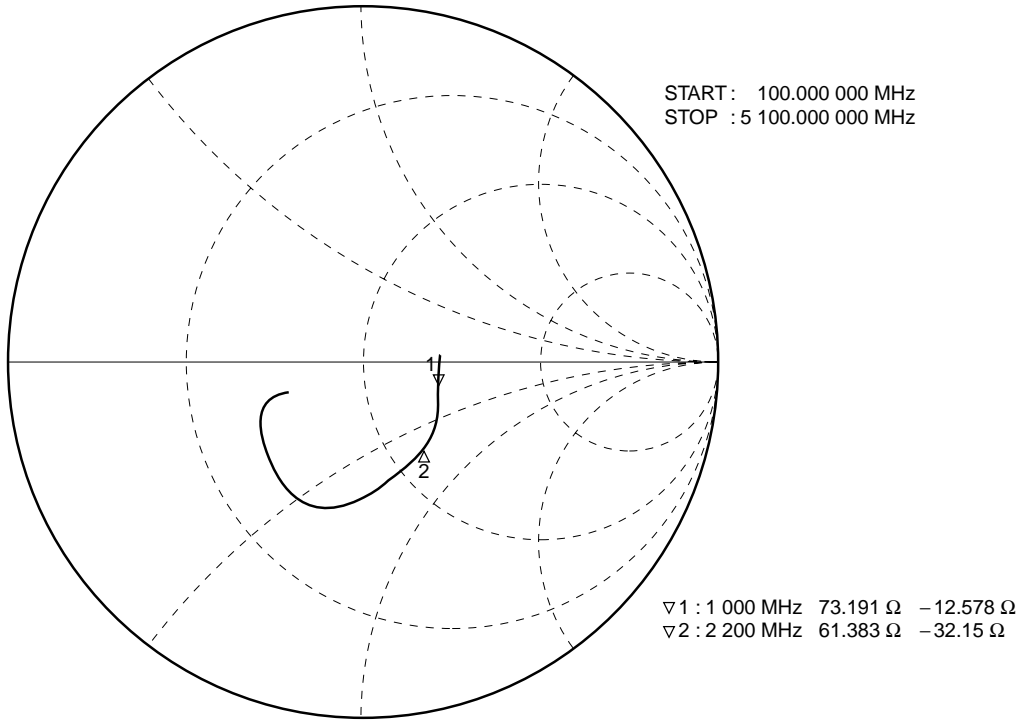

S<sub>22</sub>-FREQUENCY

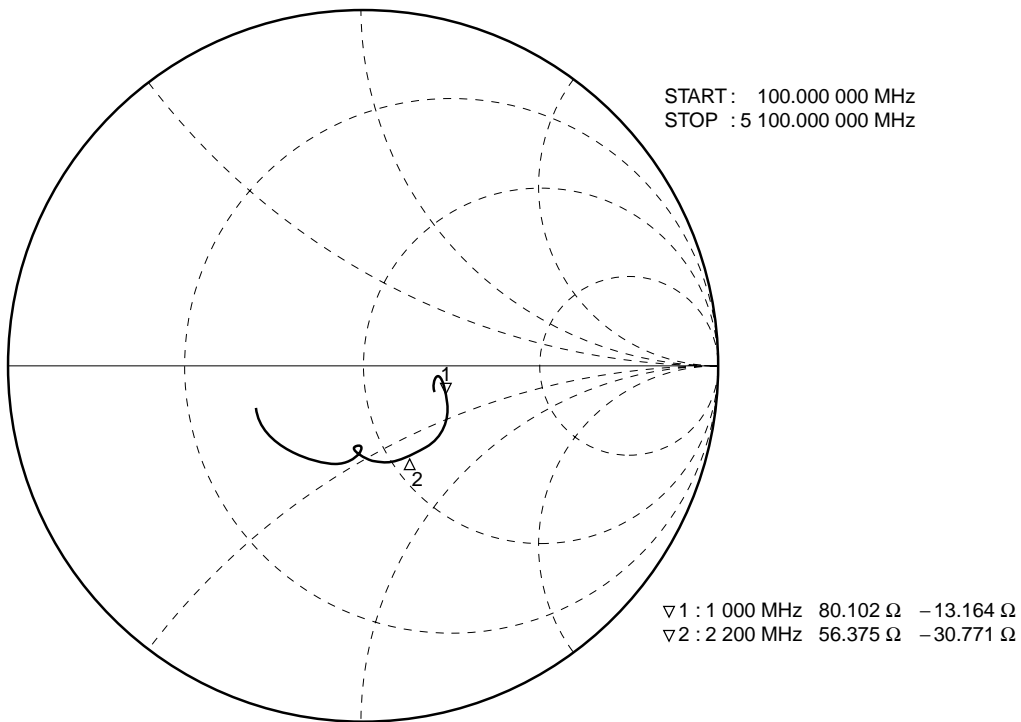

PACKAGE DIMENSIONS

6-PIN SUPER MINIMOLD (UNIT: mm)

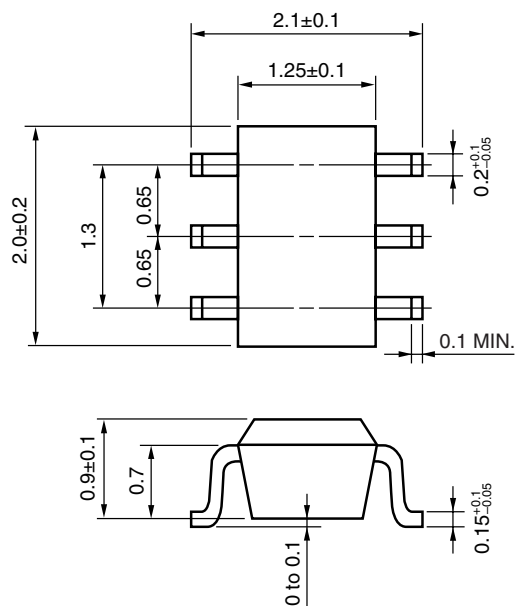

**NOTES ON CORRECT USE**

- (1) Observe precautions for handling because of electro-static sensitive devices.
- (2) Form a ground pattern as widely as possible to minimize ground impedance (to prevent undesired oscillation).  
All the ground terminals must be connected together with wide ground pattern to decrease impedance difference.
- (3) The bypass capacitor should be attached to the Vcc line.
- (4) The inductor (L) must be attached between Vcc and output pins. The inductance value should be determined in accordance with desired frequency.
- (5) The DC cut capacitor must be attached to input and output pin.

**RECOMMENDED SOLDERING CONDITIONS**

This product should be soldered and mounted under the following recommended conditions. For soldering methods and conditions other than those recommended below, contact your nearby sales office.

Soldering Method	Soldering Conditions	Condition Symbol
Infrared Reflow	Peak temperature (package surface temperature) : 260°C or below Time at peak temperature : 10 seconds or less Time at temperature of 220°C or higher : 60 seconds or less Preheating time at 120 to 180°C : 120±30 seconds Maximum number of reflow processes : 3 times Maximum chlorine content of rosin flux (% mass) : 0.2%(Wt.) or below	IR260
Wave Soldering	Peak temperature (molten solder temperature) : 260°C or below Time at peak temperature : 10 seconds or less Preheating temperature (package surface temperature) : 120°C or below Maximum number of flow processes : 1 time Maximum chlorine content of rosin flux (% mass) : 0.2%(Wt.) or below	WS260
Partial Heating	Peak temperature (terminal temperature) : 350°C or below Soldering time (per side of device) : 3 seconds or less Maximum chlorine content of rosin flux (% mass) : 0.2%(Wt.) or below	HS350

**Caution Do not use different soldering methods together (except for partial heating).**

Subject: Compliance with EU Directives

CEL certifies, to its knowledge, that semiconductor and laser products detailed below are compliant with the requirements of European Union (EU) Directive 2002/95/EC Restriction on Use of Hazardous Substances in electrical and electronic equipment (RoHS) and the requirements of EU Directive 2003/11/EC Restriction on Penta and Octa BDE.

CEL Pb-free products have the same base part number with a suffix added. The suffix –A indicates that the device is Pb-free. The –AZ suffix is used to designate devices containing Pb which are exempted from the requirement of RoHS directive (\*). In all cases the devices have Pb-free terminals. All devices with these suffixes meet the requirements of the RoHS directive.

This status is based on CEL’s understanding of the EU Directives and knowledge of the materials that go into its products as of the date of disclosure of this information.

Restricted Substance per RoHS	Concentration Limit per RoHS (values are not yet fixed)	Concentration contained in CEL devices	
		-A	-AZ
Lead (Pb)	< 1000 PPM	Not Detected	(*)
Mercury	< 1000 PPM	Not Detected	
Cadmium	< 100 PPM	Not Detected	
Hexavalent Chromium	< 1000 PPM	Not Detected	
PBB	< 1000 PPM	Not Detected	
PBDE	< 1000 PPM	Not Detected	

If you should have any additional questions regarding our devices and compliance to environmental standards, please do not hesitate to contact your local representative.

**Important Information and Disclaimer:** Information provided by CEL on its website or in other communications concerning the substance content of its products represents knowledge and belief as of the date that it is provided. CEL bases its knowledge and belief on information provided by third parties and makes no representation or warranty as to the accuracy of such information. Efforts are underway to better integrate information from third parties. CEL has taken and continues to take reasonable steps to provide representative and accurate information but may not have conducted destructive testing or chemical analysis on incoming materials and chemicals. CEL and CEL suppliers consider certain information to be proprietary, and thus CAS numbers and other limited information may not be available for release.

In no event shall CEL’s liability arising out of such information exceed the total purchase price of the CEL part(s) at issue sold by CEL to customer on an annual basis.

See CEL Terms and Conditions for additional clarification of warranties and liability.