



BBA-322-A  
BBA-519-A



## BBA SERIES RF AMPLIFIER DATA GUIDE

### DESCRIPTION

The BBA Series is a family of low-cost high-performance broadband RF amplifiers. The modules are ideally suited to a wide range of amplification and buffering applications, including extending the range of Linx's own RF modules (where legally appropriate). Housed in a compact SMD package, the hybrid amps are matched to 50Ω source and load impedances. The modules utilize a GaHBT gain stage, which yields high gain and IP3, excellent flatness, and low noise. The BBA-322-A is the high gain model and is suitable for the LNA stage of many receivers. This extra gain stage on the front end of a receiver can improve the sensitivity and provide a greater range for the product. The BBA-519-A is the high power model and is suitable for the final gain stage in a transmitter. This amplifier can boost the output power of a transmitter to much higher levels and provide a significant increase in range (where legally appropriate).

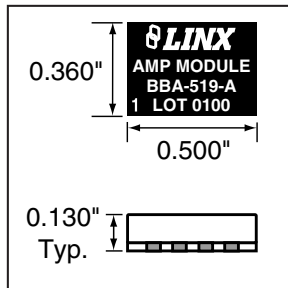

Figure 1: BBA Package Dimensions

### BBA SERIES FEATURES

- Prematched for 50Ω impedance
- No external RF components required
- Exceptional gain flatness
- Compact SMD package
- Operates from a single supply

### BBA-322-A FEATURES

- High gain
- 3.8dB noise figure
- DC-3GHz broadband operation
- +20dB small signal gain at 900MHz
- Up to +10dB (10mW) linear output power

### BBA-519-A FEATURES

- High output
- 4.8dB noise figure
- 10MHz-3GHz broadband operation
- +18dB small signal gain at 900MHz
- Up to +17dB (50mW) linear output power

### APPLICATIONS INCLUDE

- TX / RX Range Enhancement
- IF or RF Buffering
- Driver or Final Stage for PA
- General Purpose Gain Blocks

### ORDERING INFORMATION

PART #	DESCRIPTION
BBA-322-A	High Gain RF Amplifier
BBA-519-A	High Power RF Amplifier

Amplifiers are supplied in tubes of 50 pcs.

Revised 1/28/08

## BBA-322-A ELECTRICAL SPECIFICATIONS

Parameter	Designation	Min.	Typical	Max.	Units	Notes
<b>POWER SUPPLY</b>						
Operating Voltage	V <sub>CC</sub>	4.8	–	5.2	VDC	1
Supply Current	I <sub>CC</sub>	–	35.0	65.0	mA	–
<b>AMPLIFIER SECTION</b>						
Frequency Range	F <sub>C</sub>	DC	–	3,000	MHz	2
Gain:	–	-50	–	+50	kHz	–
@ 100MHz	–	–	21.0	–	dB	–
@ 1,000MHz	–	–	20.0	–	dB	–
@ 2,000MHz	–	–	17.0	–	dB	–
@ 3,000MHz	–	–	14.0	–	dB	–
Gain Ripple	–	–	±2	–	dB	3
Noise Figure	–	–	3.8	–	dB	4
Input VSWR	–	–	2.3	–	–	5
Output VSWR	–	–	2.1	–	–	5
Output IP3	–	–	+22.5	–	dBm	6
Output P <sub>1dB</sub>	–	–	+11.2	–	dBm	4
Reverse Isolation	–	–	20	–	dB	4
<b>ANTENNA PORT</b>						
RF Input Impedance	R <sub>IN</sub>	–	50	–	Ω	–
<b>ENVIRONMENTAL</b>						
Operating Temperature Range	–	-40	–	+85	°C	–

### Notes

- 5.2V to 12V range is possible with the appropriate current-limiting resistor.
- T = 25°C, I<sub>CC</sub> = 35mA.
- 100MHz to 2,000MHz.
- At 2,000MHz.
- In a 50Ω system, DC to 3,000MHz.
- At 2,000MHz ± 50kHz, P<sub>tone</sub> = -18dBm.

## ABSOLUTE MAXIMUM RATINGS

Supply Voltage V <sub>CC</sub>	+4.8	to	+5.2	VDC
Supply Current			65	mA
RF Input			+15	dBm
Operating Temperature	0	to	+70	°C
Storage Temperature	-60	to	+150	°C
Soldering Temperature	+225°C for 10 seconds			

**\*NOTE\*** Exceeding any of the limits of this section may lead to permanent damage to the device. Furthermore, extended operation at these maximum ratings may reduce the life of this device.

### \*CAUTION\*

This product incorporates numerous static-sensitive components. Always wear an ESD wrist strap and observe proper ESD handling procedures when working with this device. Failure to observe this precaution may result in module damage or failure.

## BBA-519-A ELECTRICAL SPECIFICATIONS

Parameter	Designation	Min.	Typical	Max.	Units	Notes
<b>POWER SUPPLY</b>						
Operating Voltage	V <sub>CC</sub>	4.8	–	5.2	VDC	1
Supply Current	I <sub>CC</sub>	–	60.0	65.0	mA	–
<b>AMPLIFIER SECTION</b>						
Frequency Range	F <sub>C</sub>	10	–	4,000	MHz	2
Gain:	–	-50	–	+50	kHz	–
@ 100MHz	–	–	18.5	–	dB	–
@ 1,000MHz	–	–	17.5	–	dB	–
@ 2,000MHz	–	–	15.5	–	dB	–
@ 3,000MHz	–	–	13.5	–	dB	–
@ 4,000MHz	–	–	12.5	–	dB	–
Gain Ripple	–	–	±2	–	dB	3
Noise Figure	–	–	4.8	–	dB	4
Input VSWR	–	–	2.1	–	–	5
Output VSWR	–	–	1.8	–	–	5
Output IP3	–	–	+33	–	dBm	6
Output P <sub>1dB</sub>	–	–	+18.5	–	dBm	7
Reverse Isolation	–	–	20	–	dB	4
<b>ANTENNA PORT</b>						
RF Input Impedance	R <sub>IN</sub>	–	50	–	Ω	–
<b>ENVIRONMENTAL</b>						
Operating Temperature Range	–	-40	–	+85	°C	–

### Notes

- 5.2V to 12V range is possible with the appropriate current-limiting resistor.
- T = 25°C, I<sub>CC</sub> = 65mA.
- 100MHz to 2,000MHz.
- At 2,000MHz.
- In a 50Ω system, DC to 4,000MHz.
- At 1,000MHz ± 50kHz, P<sub>tone</sub> = -10dBm.
- At 1,000MHz.

## ABSOLUTE MAXIMUM RATINGS

Supply Voltage V <sub>CC</sub>	+4.8	to	+5.2	VDC
Supply Current			120	mA
RF Input			+13	dBm
Operating Temperature	0	to	+70	°C
Storage Temperature	-60	to	+150	°C
Soldering Temperature	+225°C for 10 seconds			

**\*NOTE\*** Exceeding any of the limits of this section may lead to permanent damage to the device. Furthermore, extended operation at these maximum ratings may reduce the life of this device.

**\*NOTE\*** The purchaser of this device should be aware that approvals may be required by applicable governing bodies for systems producing RF energy. It is the responsibility of the user to determine and adhere to the appropriate regulations for the region in which operation is intended.

## PERFORMANCE DATA

These performance parameters are based on module operation at 25°C from a 5.0VDC supply with a -50dBm input unless otherwise noted. Figure 2 illustrates the connections necessary for testing and operation. It is recommended all ground pins be connected to the ground plane.

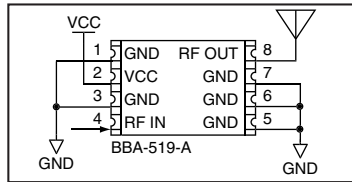

Figure 2: Test / Basic Application Circuit

## PIN ASSIGNMENTS

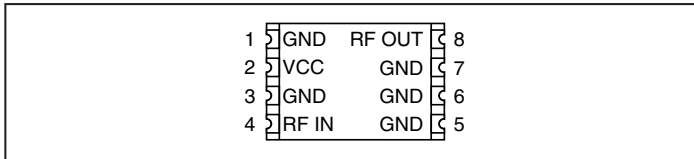

Figure 3: BBA Series Amplifier Pinout (Top View)

## PIN DESCRIPTIONS

Pin #	Name	Description
1	GND	Analog Ground
2	V <sub>CC</sub>	Supply Voltage
3	GND	Analog Ground
4	RF IN	50-ohm RF Input
5	GND	Analog Ground
6	GND	Analog Ground
7	GND	Analog Ground
8	RF OUT	50-ohm RF Output

Table 1: BBA Series Amplifier Pin Descriptions

## THEORY OF OPERATION

The BBA Series is a family of low-cost, high-performance, broadband RF amplifiers. They utilize an advanced Gallium Arsenide Heterojunction Bipolar Transistor (HBT) gain stage, which yields high gain and IP<sub>3</sub>, excellent flatness, and low noise. They are self-contained with 50Ω input and output impedances and require only one external DC biasing resistor to operate as specified.

The BBA-322-A is the high gain model and is suitable for the LNA stage of many receivers. This extra gain stage on the front end of a receiver can improve the sensitivity and provide a greater range for the product.

The BBA-519-A is the high power model and is suitable for the final gain stage in a transmitter. This amplifier can boost the output power of a transmitter to much higher levels and provide a significant increase in range (where legally appropriate).

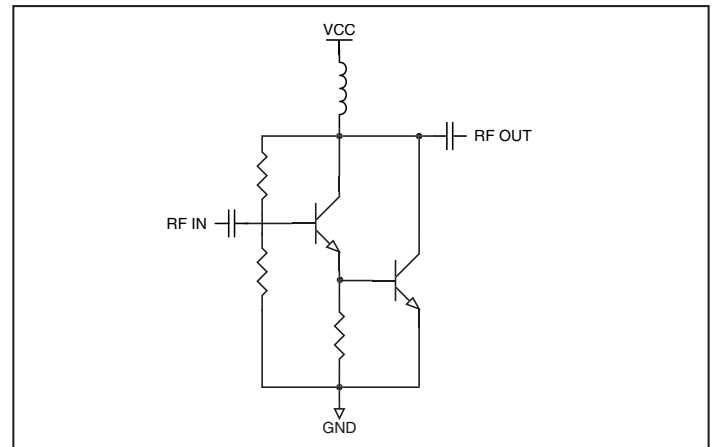

Figure 4: BBA Series Amplifier Schematic

## OPERATIONAL CONSIDERATIONS

The use of a gain stage can produce a significant increase in the range performance of an RF link. It is important to note that it can also introduce detrimental effects, such as the following:

- Amplification of harmonics and LO along with the fundamental carrier frequency.
- Adverse effect on the front-end noise figure on receivers.
- Potential damage if the receiver input is not capable of accommodating high input power levels.
- Risk of generating illegal power levels and unacceptable interference.

It is up to the designer to ensure that the final product will comply with all appropriate regulations in the county of intended use.

## POWER SUPPLY REQUIREMENTS

The module does not have an internal voltage regulator; therefore it requires a clean, well-regulated power source. While it is preferable to power the unit from a battery, the unit can also be operated from a power supply as long as noise is less than 20mV. Power supply noise can significantly affect the performance; therefore, providing a clean power supply for the module should be a high priority during design.

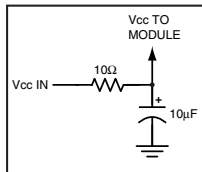

Figure 5: Supply Filter

A 10Ω resistor in series with the supply followed by a 10μF tantalum capacitor from V<sub>CC</sub> to ground will help in cases where the quality of supply power is poor. These values may need to be adjusted depending on the noise present on the supply line.

The power supply must be regulated to within the primary range specified or the maximum current limited using an appropriate resistance in series with the amplifier's positive supply pin. Failure to observe the supply limits will irreparably damage the device. The resistor should be selected so that the device current is limited to or less than the maximum rated current. The resistor value may be easily selected using the following formula:

$$R = \frac{V_{\text{SUPPLY}} - V_{\text{DEVICE TYP.}}}{I_{\text{CC}}}$$

*Example:*  
 BBA-519-A @ 9V Supply  $R = \frac{9 - 5}{60 \times 10^{-3}} = \frac{9 - 5}{60 \times 10^{-3}} = \frac{4}{0.06} = 66\Omega$

## TYPICAL APPLICATIONS

The schematic in the figure below shows a typical configuration for amplifying the output of a transmitter.

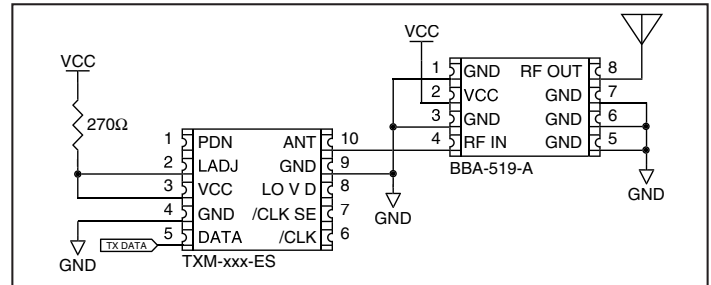

Figure 6: Typical Application Circuit

In this circuit, the BBA-519-A amplifies the output of the ES Series transmitter. The transmitter operates on 3V while the amplifier requires 5V, so a 270Ω resistor is used to drop the 5V supply to 3V for the transmitter.

This configuration would result in a 6 to 7 times increase in system range. Note that such output levels may render the transmitter illegal for operation in certain countries, so it is up to the designer to ensure that the product will comply with the appropriate regulations.

## BOARD LAYOUT GUIDELINES

If you are at all familiar with RF devices, you may be concerned about specialized board layout requirements. Fortunately, because of the care taken by Linx in designing the modules, integrating them is very straightforward. Despite this ease of application, it is still necessary to maintain respect for the RF stage and exercise appropriate care in layout and application in order to maximize performance and ensure reliable operation. The antenna can also be influenced by layout choices. Please review this data guide in its entirety prior to beginning your design. By adhering to good layout principles and observing some basic design rules, you will be on the path to RF success.

The adjacent figure shows the suggested PCB footprint for the module. The actual pad dimensions are shown in the Pad Layout section of this manual. A ground plane (as large as possible) should be placed on a lower layer of your PCB opposite the module. This ground plane can also be critical to the performance of your antenna, which will be discussed later. There should not be any ground or traces under the module on the same layer as the module, just bare PCB.

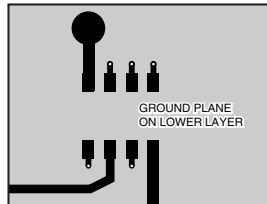

Figure 7: Suggested PCB Layout

During prototyping, the module should be soldered to a properly laid-out circuit board. The use of prototyping or "perf" boards will result in horrible performance and is strongly discouraged.

No conductive items should be placed within 0.15in of the module's top or sides.

Do not route PCB traces directly under the module. The underside of the module has numerous signal-bearing traces and vias that could short or couple to traces on the product's circuit board.

The module's ground lines should each have their own via to the ground plane and be as short as possible.

The module should, as much as reasonably possible, be isolated from other components on your PCB, especially high-frequency circuitry such as crystal oscillators, switching power supplies, and high-speed bus lines. Make sure internal wiring is routed away from the module and antenna, and is secured to prevent displacement.

The power supply filter should be placed close to the module's  $V_{CC}$  line.

In some instances, a designer may wish to encapsulate or "pot" the product. Many Linx customers have done this successfully; however, there are a wide variety of potting compounds with varying dielectric properties. Since such compounds can considerably impact RF performance, it is the responsibility of the designer to carefully evaluate and qualify the impact and suitability of such materials.

The trace from the module to the antenna should be kept as short as possible. A simple trace is suitable for runs up to 1/8-inch for antennas with wide bandwidth characteristics. For longer runs or to avoid detuning narrow bandwidth antennas, such as a helical, use a 50-ohm coax or 50-ohm microstrip transmission line as described in the following section.

## MICROSTRIP DETAILS

A transmission line is a medium whereby RF energy is transferred from one place to another with minimal loss. This is a critical factor, especially in high-frequency products like Linx RF modules, because the trace leading to the module's antenna can effectively contribute to the length of the antenna, changing its resonant bandwidth. In order to minimize loss and detuning, some form of transmission line between the antenna and the module should be used, unless the antenna can be placed very close (<1/8in.) to the module. One common form of transmission line is a coax cable, another is the microstrip. This term refers to a PCB trace running over a ground plane that is designed to serve as a transmission line between the module and the antenna. The width is based on the desired characteristic impedance of the line, the thickness of the PCB, and the dielectric constant of the board material. For standard 0.062in thick FR-4 board material, the trace width would be 111 mils. The correct trace width can be calculated for other widths and materials using the information below. Handy software for calculating microstrip lines is also available on the Linx website, [www.linxtechnologies.com](http://www.linxtechnologies.com).

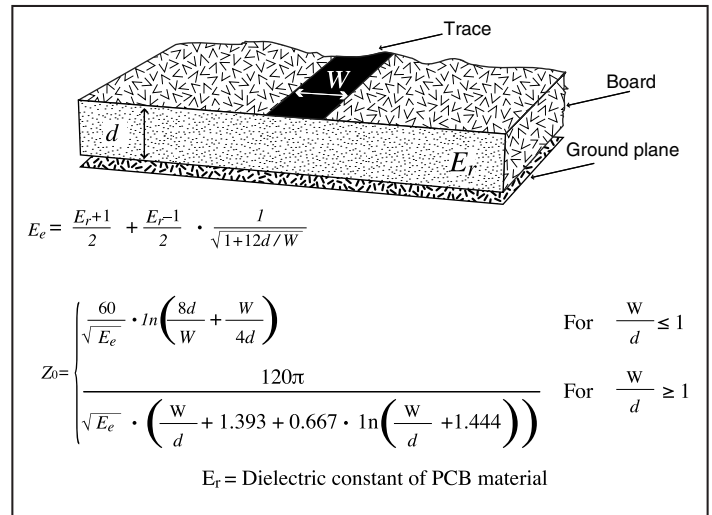

Figure 8: Microstrip Formulas

Dielectric Constant	Width/Height (W/d)	Effective Dielectric Constant	Characteristic Impedance
4.80	1.8	3.59	50.0
4.00	2.0	3.07	51.0
2.55	3.0	2.12	48.0

## PAD LAYOUT

The following pad layout diagram is designed to facilitate both hand and automated assembly.

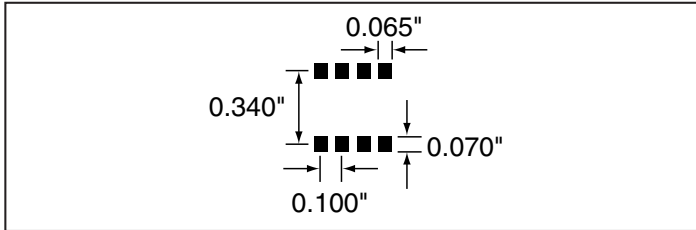

Figure 9: Recommended PCB Layout

## PRODUCTION GUIDELINES

The modules are housed in a hybrid SMD package that supports hand or automated assembly techniques. Since the modules contain discrete components internally, the assembly procedures are critical to ensuring the reliable function of the modules. The following procedures should be reviewed with and practiced by all assembly personnel.

## HAND ASSEMBLY

Pads located on the bottom of the module are the primary mounting surface. Since these pads are inaccessible during mounting, castellations that run up the side of the module have been provided to facilitate solder wicking to the module's underside. This allows for very quick hand soldering for prototyping and small volume production.

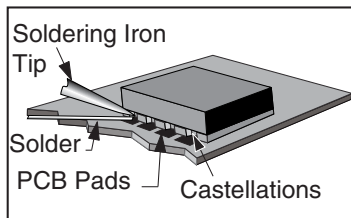

Figure 10: Soldering Technique

If the recommended pad guidelines have been followed, the pads will protrude slightly past the edge of the module. Use a fine soldering tip to heat the board pad and the castellation, then introduce solder to the pad at the module's edge. The solder will wick underneath the module, providing reliable attachment. Tack one module corner first and then work around the device, taking care not to exceed the times listed below.

### Absolute Maximum Solder Times

**Hand-Solder Temp. TX +225°C for 10 Seconds**

**Hand-Solder Temp. RX +225°C for 10 Seconds**

**Recommended Solder Melting Point +180°C**

**Reflow Oven: +220°C Max. (See adjoining diagram)**

## AUTOMATED ASSEMBLY

For high-volume assembly, most users will want to auto-place the modules. The modules have been designed to maintain compatibility with reflow processing techniques; however, due to their hybrid nature, certain aspects of the assembly process are far more critical than for other component types.

Following are brief discussions of the three primary areas where caution must be observed.

### Reflow Temperature Profile

The single most critical stage in the automated assembly process is the reflow stage. The reflow profile below should not be exceeded, since excessive temperatures or transport times during reflow will irreparably damage the modules. Assembly personnel will need to pay careful attention to the oven's profile to ensure that it meets the requirements necessary to successfully reflow all components while still remaining within the limits mandated by the modules. The figure below shows the recommended reflow oven profile for the modules.

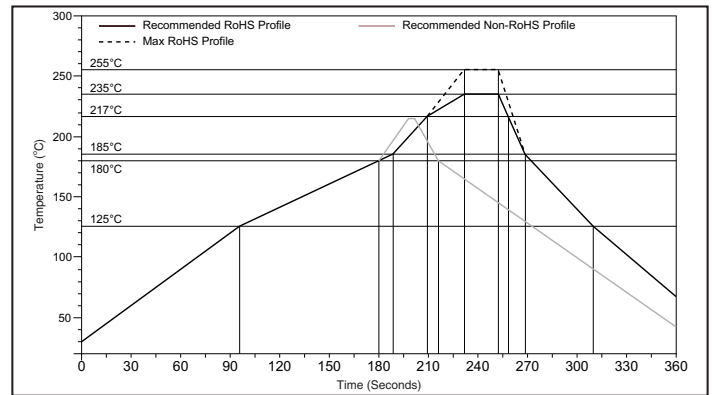

Figure 11: Maximum Reflow Profile

### Shock During Reflow Transport

Since some internal module components may reflow along with the components placed on the board being assembled, it is imperative that the modules not be subjected to shock or vibration during the time solder is liquid. Should a shock be applied, some internal components could be lifted from their pads, causing the module to not function properly.

### Washability

The modules are wash resistant, but are not hermetically sealed. Linx recommends wash-free manufacturing; however, the modules can be subjected to a wash cycle provided that a drying time is allowed prior to applying electrical power to the modules. The drying time should be sufficient to allow any moisture that may have migrated into the module to evaporate, thus eliminating the potential for shorting damage during power-up or testing. If the wash contains contaminants, the performance may be adversely affected, even after drying.



## U.S. CORPORATE HEADQUARTERS

### **LINX TECHNOLOGIES, INC.**

**159 ORT LANE  
MERLIN, OR 97532**

**PHONE: (541) 471-6256**

**FAX: (541) 471-6251**

**[www.linxtechnologies.com](http://www.linxtechnologies.com)**

### **Disclaimer**

Linx Technologies is continually striving to improve the quality and function of its products. For this reason, we reserve the right to make changes to our products without notice. The information contained in this Overview Guide is believed to be accurate as of the time of publication. Specifications are based on representative lot samples. Values may vary from lot-to-lot and are not guaranteed. "Typical" parameters can and do vary over lots and application. Linx Technologies makes no guarantee, warranty, or representation regarding the suitability of any product for use in any specific application. It is the customer's responsibility to verify the suitability of the part for the intended application. NO LINX PRODUCT IS INTENDED FOR USE IN ANY APPLICATION WHERE THE SAFETY OF LIFE OR PROPERTY IS AT RISK.

Linx Technologies DISCLAIMS ALL WARRANTIES OF MERCHANTABILITY AND FITNESS FOR A PARTICULAR PURPOSE. IN NO EVENT SHALL LINX TECHNOLOGIES BE LIABLE FOR ANY OF CUSTOMER'S INCIDENTAL OR CONSEQUENTIAL DAMAGES ARISING IN ANY WAY FROM ANY DEFECTIVE OR NON-CONFORMING PRODUCTS OR FOR ANY OTHER BREACH OF CONTRACT BY LINX TECHNOLOGIES. The limitations on Linx Technologies' liability are applicable to any and all claims or theories of recovery asserted by Customer, including, without limitation, breach of contract, breach of warranty, strict liability, or negligence. Customer assumes all liability (including, without limitation, liability for injury to person or property, economic loss, or business interruption) for all claims, including claims from third parties, arising from the use of the Products. The Customer will indemnify, defend, protect, and hold harmless Linx Technologies and its officers, employees, subsidiaries, affiliates, distributors, and representatives from and against all claims, damages, actions, suits, proceedings, demands, assessments, adjustments, costs, and expenses incurred by Linx Technologies as a result of or arising from any Products sold by Linx Technologies to Customer. Under no conditions will Linx Technologies be responsible for losses arising from the use or failure of the device in any application, other than the repair, replacement, or refund limited to the original product purchase price. Devices described in this publication may contain proprietary, patented, or copyrighted techniques, components, or materials. Under no circumstances shall any user be conveyed any license or right to the use or ownership of such items.

© 2008 by Linx Technologies, Inc. The stylized Linx logo, Linx, "Wireless Made Simple", CipherLinx, and the stylized CL logo are the trademarks of Linx Technologies, Inc.  
Printed in U.S.A.