

Heterostructure Field Effect Transistor (GaAs HFET)

Broadband High Linearity Amplifier

The MMH3111NT1 is a General Purpose Amplifier that is internally input and output prematched. It is designed for a broad range of Class A, small-signal, high linearity, general purpose applications. It is suitable for applications with frequencies from 250 to 4000 MHz such as Cellular, PCS, WLL, PHS, CATV, VHF, UHF, UMTS and general small-signal RF.

Features

- Frequency: 250 to 4000 MHz
- P1dB: 22.5 dBm @ 900 MHz
- Small-Signal Gain: 12 dB @ 900 MHz
- Third Order Output Intercept Point: 44 dBm @ 900 MHz
- Single 5 Volt Supply
- Internally Prematched to 50 Ohms
- Internally Biased
- Low Cost SOT-89 Surface Mount Package
- RoHS Compliant
- In Tape and Reel. T1 Suffix = 1,000 Units per 12 mm, 7 inch Reel.

MMH3111NT1

**250-4000 MHz, 12 dB
22.5 dBm
GaAs HFET**

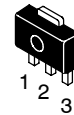

**CASE 1514-02, STYLE 2
SOT-89
PLASTIC**

Table 1. Typical Performance (1)

Characteristic	Symbol	900 MHz	2140 MHz	3500 MHz	Unit
Small-Signal Gain (S21)	G_p	12	11.3	10	dB
Input Return Loss (S11)	IRL	-14	-15	-16	dB
Output Return Loss (S22)	ORL	-14	-19	-14	dB
Power Output @1dB Compression	P1db	22.5	22	22	dBm
Third Order Output Intercept Point	IP3	44	44	42	dBm

1. $V_{DD} = 5$ Vdc, $T_A = 25^\circ\text{C}$, 50 ohm system

Table 2. Maximum Ratings

Rating	Symbol	Value	Unit
Supply Voltage	V_{DD}	6	V
Supply Current	I_{DD}	300	mA
RF Input Power	P_{in}	20	dBm
Storage Temperature Range	T_{stg}	-65 to +150	$^\circ\text{C}$
Junction Temperature (2)	T_J	150	$^\circ\text{C}$

2. For reliable operation, the junction temperature should not exceed 150°C .

Table 3. Thermal Characteristics ($V_{DD} = 5$ Vdc, $I_{DD} = 150$ mA, $T_C = 25^\circ\text{C}$)

Characteristic	Symbol	Value (3)	Unit
Thermal Resistance, Junction to Case	$R_{\theta JC}$	37.5	$^\circ\text{C/W}$

3. Refer to AN1955, *Thermal Measurement Methodology of RF Power Amplifiers*. Go to <http://www.freescale.com/rf>. Select Documentation/Application Notes - AN1955.

Table 4. Electrical Characteristics ($V_{DD} = 5 \text{ Vdc}$, 900 MHz, $T_A = 25^\circ\text{C}$, 50 ohm system, in Freescale Application Circuit)

Characteristic	Symbol	Min	Typ	Max	Unit
Small-Signal Gain (S21)	G_p	11	12	—	dB
Input Return Loss (S11)	IRL	—	-14	—	dB
Output Return Loss (S22)	ORL	—	-14	—	dB
Power Output @ 1dB Compression	P1dB	—	22.5	—	dBm
Third Order Output Intercept Point	IP3	—	44	—	dBm
Noise Figure	NF	—	3.2	—	dB
Supply Current (1)	I_{DD}	120	150	190	mA
Supply Voltage (1)	V_{DD}	—	5	—	V

1. For reliable operation, the junction temperature should not exceed 150°C .

Table 5. Functional Pin Description

Pin Number	Pin Function
1	RF _{in}
2	Ground
3	RF _{out} /DC Supply

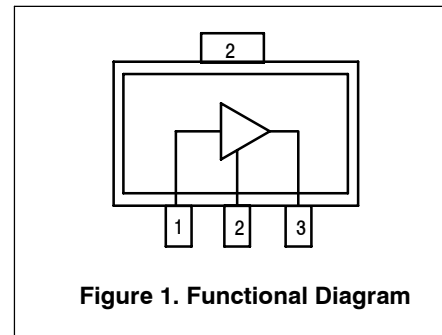

Table 6. ESD Protection Characteristics

Test Methodology	Class
Human Body Model (per JESD 22-A114)	1A (Minimum)
Machine Model (per EIA/JESD 22-A115)	A (Minimum)
Charge Device Model (per JESD 22-C101)	IV (Minimum)

Table 7. Moisture Sensitivity Level

Test Methodology	Rating	Package Peak Temperature	Unit
Per JESD 22-A113, IPC/JEDEC J-STD-020	1	260	°C

50 OHM TYPICAL CHARACTERISTICS

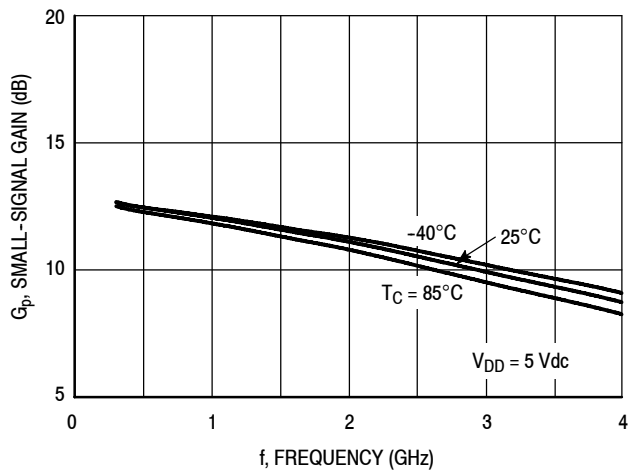

Figure 2. Small-Signal Gain (S21) versus Frequency

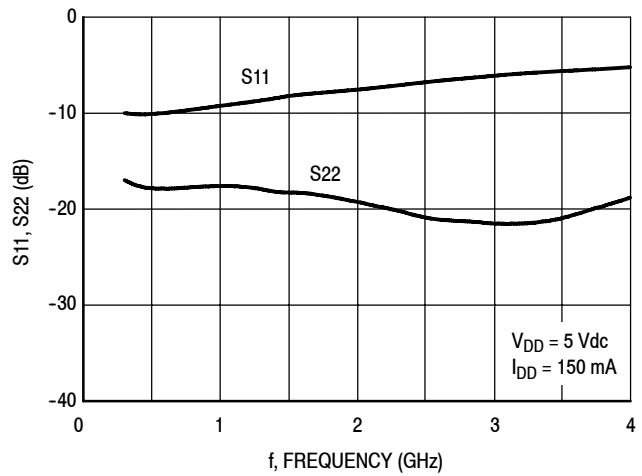

Figure 3. Input/Output Loss versus Frequency

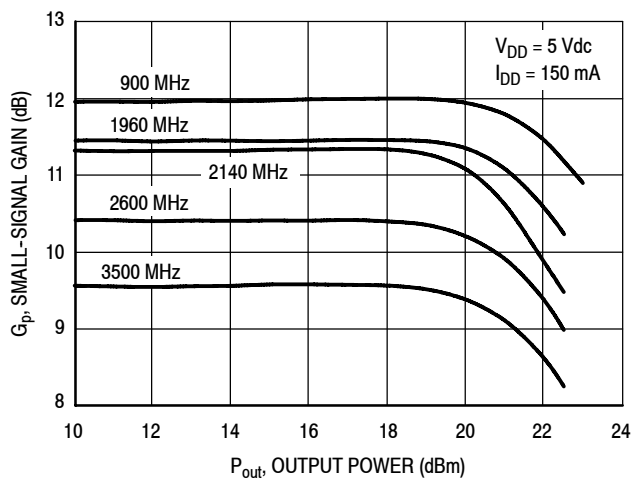

Figure 4. Small-Signal Gain versus Output Power

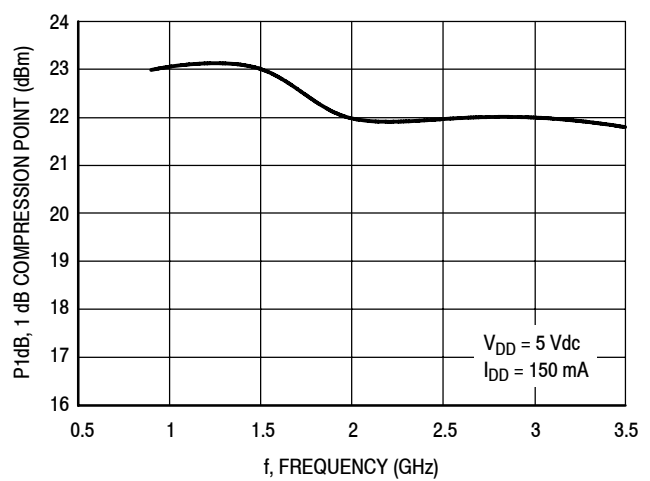

Figure 5. P1dB versus Frequency

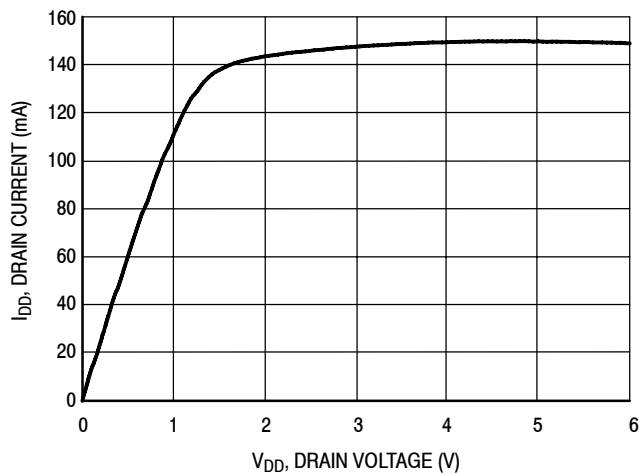

Figure 6. Drain Current versus Drain Voltage

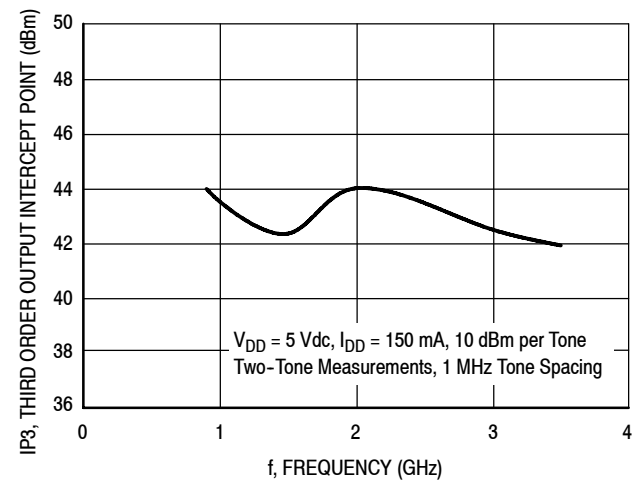

Figure 7. Third Order Output Intercept Point versus Frequency

50 OHM TYPICAL CHARACTERISTICS

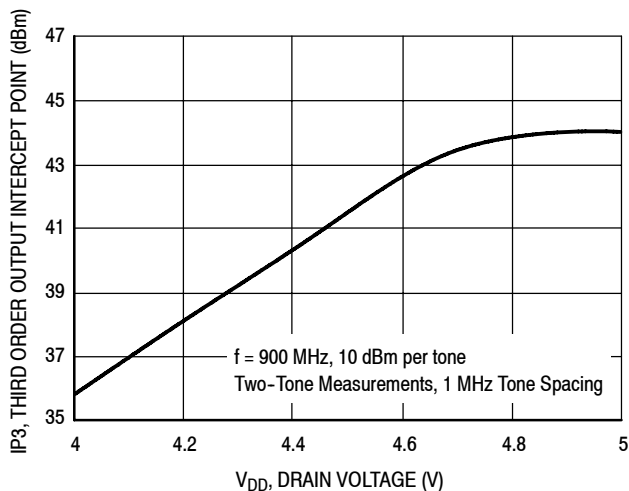

Figure 8. Third Order Output Intercept Point versus Drain Voltage

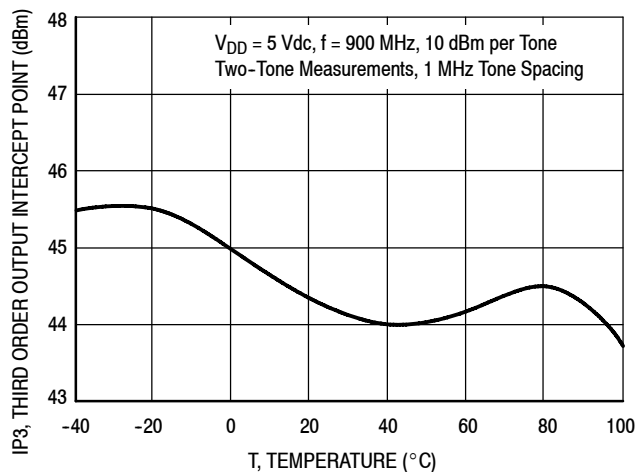

Figure 9. Third Order Output Intercept Point versus Case Temperature

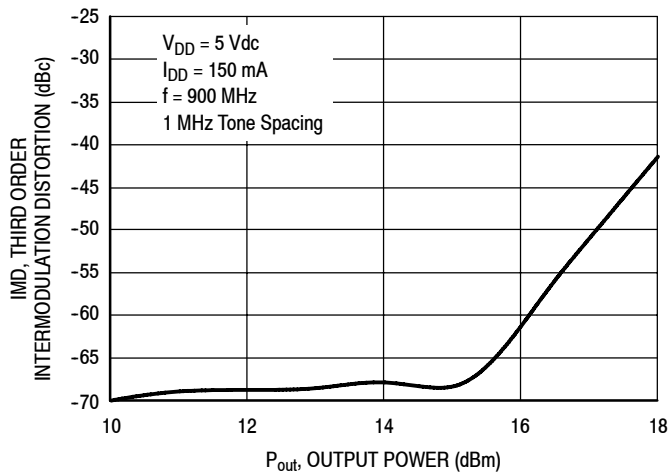

Figure 10. Third Order Intermodulation versus Output Power

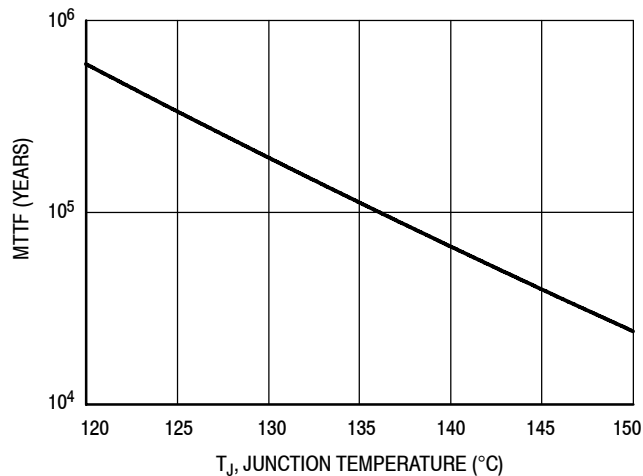

Figure 11. MTTF versus Junction Temperature
NOTE: The MTTF is calculated with $V_{DD} = 5 \text{ Vdc}$, $I_{DD} = 150 \text{ mA}$

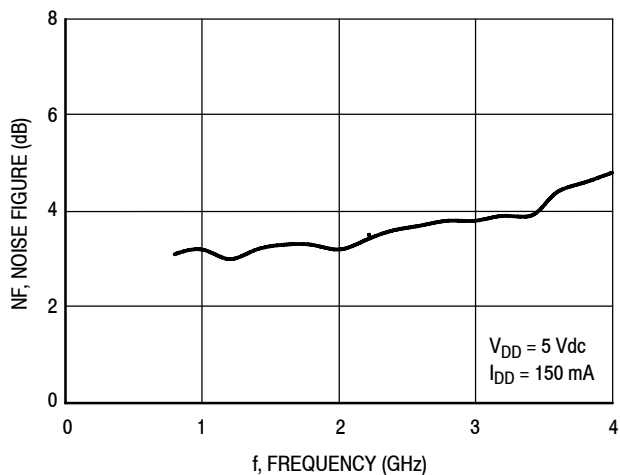

Figure 12. Noise Figure versus Frequency

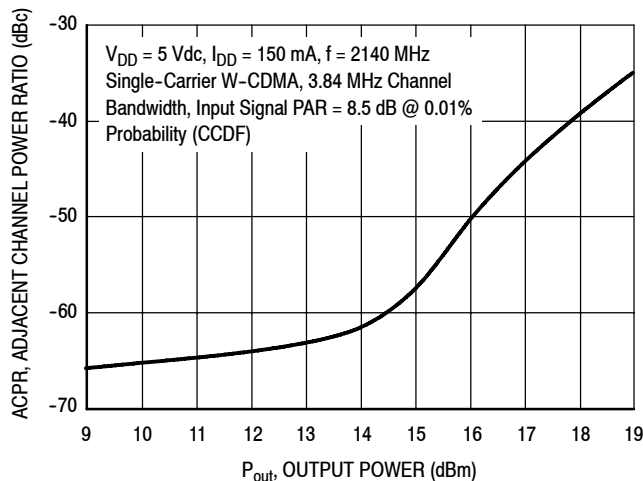
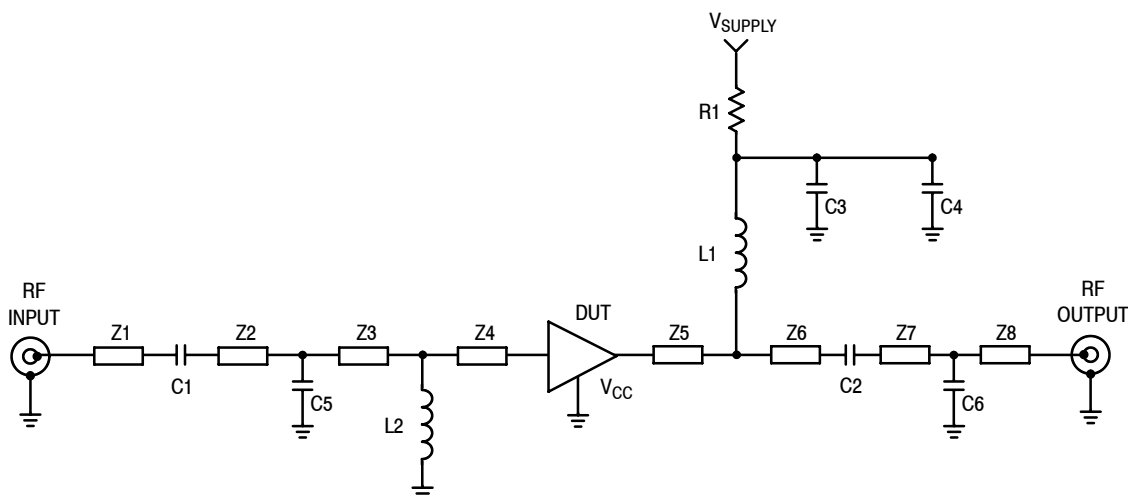

Figure 13. Single-Carrier W-CDMA Adjacent Channel Power Ratio versus Output Power

50 OHM APPLICATION CIRCUIT: 800-1900 MHz



Z1	0.347" x 0.058" Microstrip	Z6	0.403" x 0.058" Microstrip
Z2	0.068" x 0.058" Microstrip	Z7	0.086" x 0.058" Microstrip
Z3	0.418" x 0.058" Microstrip	Z8	0.261" x 0.058" Microstrip
Z4	0.089" x 0.058" Microstrip	PCB	Getek Grade ML200C, 0.031", $\epsilon_r = 4.1$
Z5	0.172" x 0.058" Microstrip		

Figure 14. 50 Ohm Test Circuit Schematic

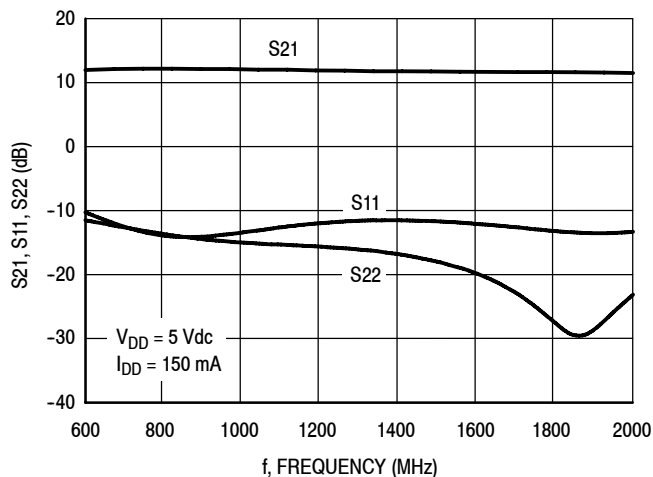

Figure 15. S21, S11 and S22 versus Frequency

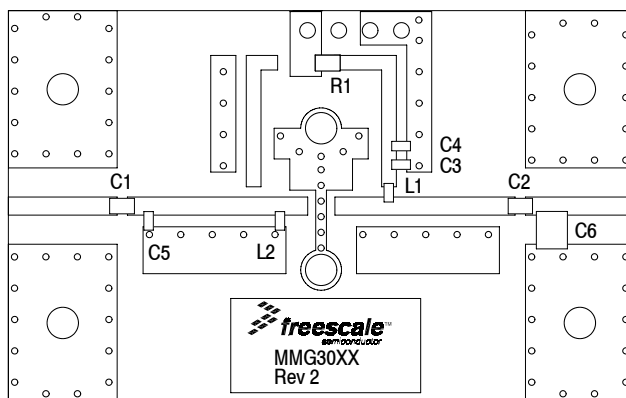

Figure 16. 50 Ohm Test Circuit Component Layout

Table 8. 50 Ohm Test Circuit Component Designations and Values

Part	Description	Part Number	Manufacturer
C1, C2	47 pF Chip Capacitors	06035J470BBS	AVX
C3	0.1 μ F Chip Capacitor	C0603C104J5RAC	Kemet
C4	1 μ F Chip Capacitor	C0603C105J5RAC	Kemet
C5	0.7 pF Chip Capacitor	06035J0R7BBS	AVX
C6	0.4 pF Chip Capacitor	12105J0R4BBS	AVX
L1	56 nH Chip Inductor	HK160856NJ-T	Taiyo Yuden
L2	12 nH Chip Inductor	HK160812NJ-T	Taiyo Yuden
R1	0 Ω , 1/10 W Chip Resistor	CRCW06030000FKEA	Vishay

50 OHM APPLICATION CIRCUIT: 1900-2200 MHz

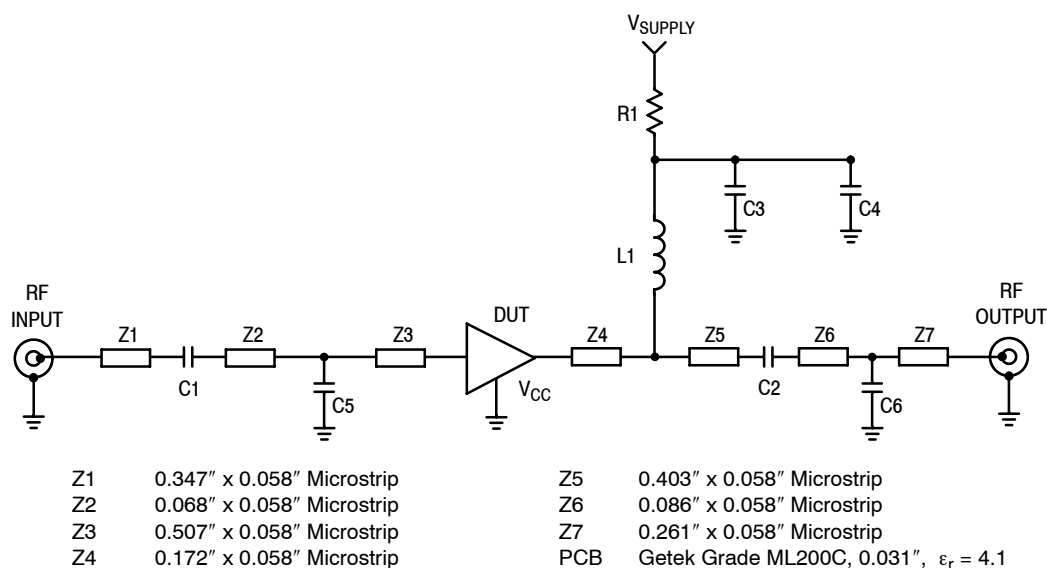

Figure 17. 50 Ohm Test Circuit Schematic

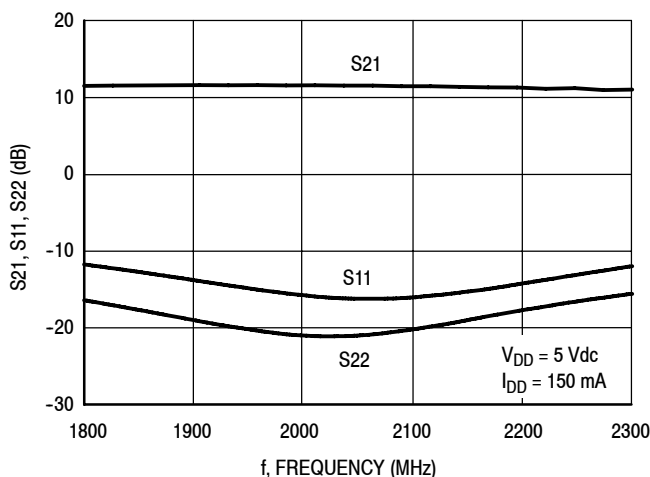

Figure 18. S21, S11 and S22 versus Frequency

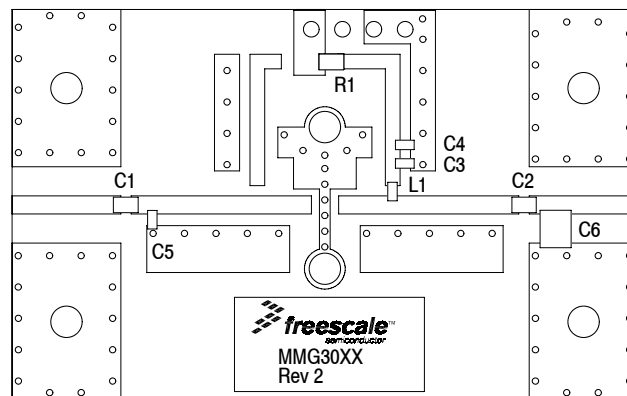

Figure 19. 50 Ohm Test Circuit Component Layout

Table 9. 50 Ohm Test Circuit Component Designations and Values

Part	Description	Part Number	Manufacturer
C1, C2	0.01 μ F Chip Capacitors	06035J470BBS	AVX
C3	0.1 μ F Chip Capacitor	C0603C104J5RAC	Kemet
C4	1 μ F Chip Capacitor	C0603C105J5RAC	Kemet
C5	0.7 pF Chip Capacitor	06035J0R7BBS	AVX
C6	0.4 pF Chip Capacitor	12105J0R4BBS	AVX
L1	56 nH Chip Inductor	HK160856NJ-T	Taiyo Yuden
R1	0 Ω , 1/10 W Chip Resistor	CRCW06030000FKEA	Vishay

50 OHM APPLICATION CIRCUIT: 2500-3800 MHz

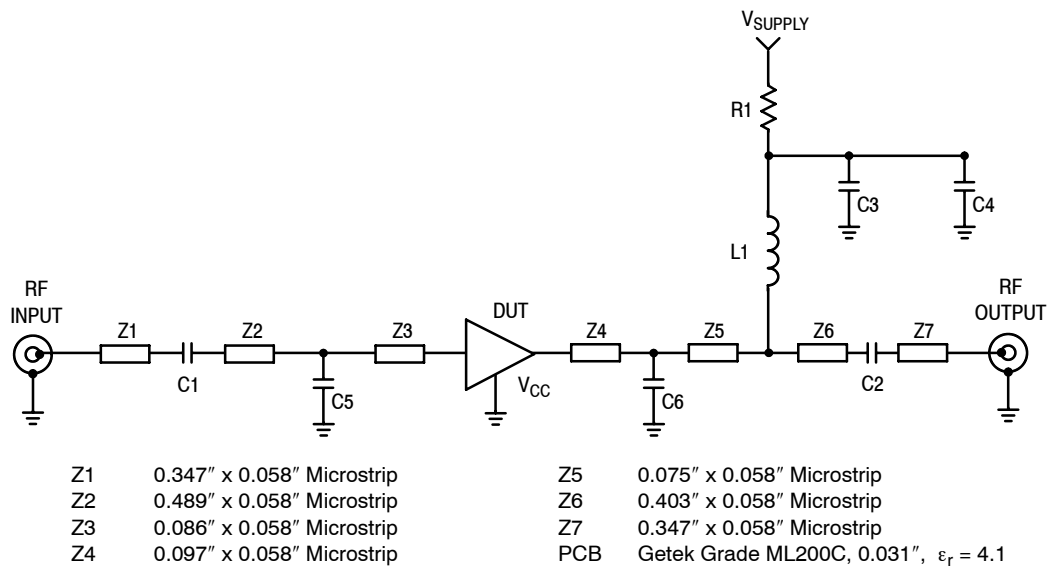

Figure 20. 50 Ohm Test Circuit Schematic

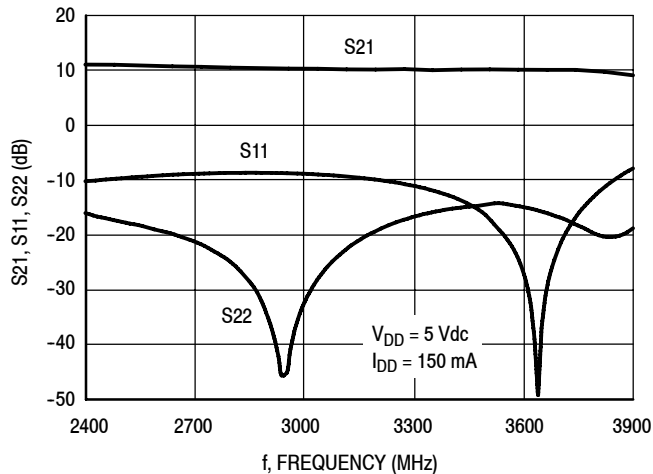

Figure 21. S21, S11 and S22 versus Frequency

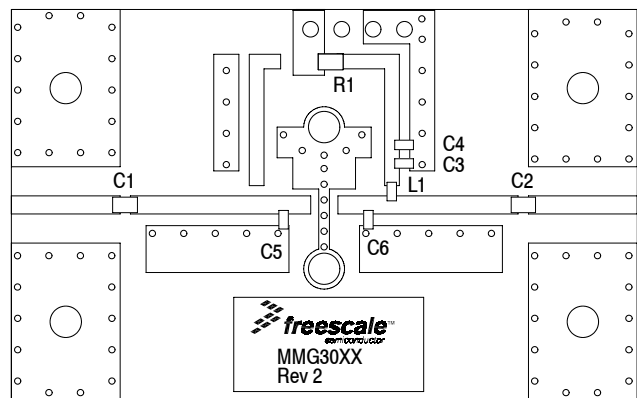

Figure 22. 50 Ohm Test Circuit Component Layout

Table 10. 50 Ohm Test Circuit Component Designations and Values

Part	Description	Part Number	Manufacturer
C1, C2	2 pF Chip Capacitors	06035J2R0BBS	AVX
C3	0.1 μ F Chip Capacitor	C0603C104J5RAC	Kemet
C4	1 μ F Chip Capacitor	C0603C105J5RAC	Kemet
C5	0.8 pF Chip Capacitor	06035J0R8BBS	AVX
C6	0.4 pF Chip Capacitor	06035J0R4BBS	AVX
L1	56 nH Chip Inductor	HK160856NJ-T	Taiyo Yuden
R1	0 Ω , 1/10 W Chip Resistor	CRCW06030000FKEA	Vishay

50 OHM TYPICAL CHARACTERISTICS

Table 11. Common Source S-Parameters ($V_{DD} = 5$ Vdc, $I_{DD} = 150$ mA, $T_A = 25^\circ\text{C}$, 50 Ohm System)

f MHz	S ₁₁		S ₂₁		S ₁₂		S ₂₂	
	S ₁₁	∠ φ	S ₂₁	∠ φ	S ₁₂	∠ φ	S ₂₂	∠ φ
100	0.329	-36.383	4.365	165.300	0.116	4.544	0.161	-47.926
150	0.324	-37.554	4.337	163.880	0.116	3.571	0.154	-47.482
250	0.322	-38.791	4.313	162.387	0.116	2.612	0.147	-46.993
300	0.318	-40.072	4.288	160.990	0.116	1.903	0.143	-46.565
350	0.315	-41.580	4.266	159.673	0.116	1.012	0.137	-46.090
400	0.313	-43.457	4.239	158.172	0.116	0.371	0.133	-45.522
450	0.313	-45.793	4.217	156.531	0.116	-1.047	0.130	-45.093
500	0.315	-48.163	4.196	154.804	0.116	-2.355	0.129	-44.795
550	0.317	-50.730	4.175	153.014	0.117	-3.521	0.129	-45.225
600	0.319	-53.308	4.154	151.195	0.117	-4.643	0.129	-45.763
650	0.322	-55.918	4.136	149.346	0.117	-5.686	0.129	-46.206
700	0.325	-58.706	4.116	147.439	0.117	-6.700	0.129	-46.966
750	0.329	-61.512	4.098	145.565	0.117	-7.693	0.130	-47.749
800	0.332	-64.233	4.078	143.660	0.117	-8.616	0.131	-48.671
850	0.336	-67.096	4.059	141.719	0.117	-9.581	0.132	-49.880
900	0.339	-69.960	4.040	139.799	0.117	-10.489	0.132	-51.046
950	0.344	-72.823	4.019	137.852	0.117	-11.398	0.133	-52.269
1000	0.347	-75.724	4.001	135.896	0.117	-12.312	0.133	-53.492
1050	0.351	-78.553	3.983	133.947	0.118	-13.198	0.133	-54.989
1100	0.355	-81.424	3.964	131.996	0.118	-14.093	0.132	-56.508
1150	0.358	-84.459	3.944	130.038	0.118	-14.998	0.131	-57.950
1200	0.362	-87.372	3.924	128.069	0.118	-15.903	0.131	-59.716
1250	0.367	-90.300	3.903	126.129	0.118	-16.821	0.129	-61.319
1300	0.371	-93.201	3.883	124.163	0.118	-17.713	0.128	-63.068
1350	0.375	-96.015	3.861	122.219	0.118	-18.623	0.126	-64.878
1400	0.380	-98.765	3.837	120.287	0.118	-19.497	0.124	-66.432
1450	0.385	-101.218	3.815	118.370	0.118	-20.349	0.123	-67.493
1500	0.391	-103.291	3.793	116.530	0.118	-21.202	0.123	-68.218
1550	0.395	-105.591	3.773	114.664	0.119	-22.024	0.123	-69.287
1600	0.398	-108.116	3.752	112.769	0.119	-22.896	0.122	-70.746
1650	0.401	-110.631	3.731	110.886	0.119	-23.793	0.121	-72.539
1700	0.404	-113.324	3.710	108.972	0.119	-24.719	0.120	-74.765
1750	0.407	-116.074	3.691	107.070	0.119	-25.638	0.118	-77.175
1800	0.410	-118.856	3.672	105.143	0.119	-26.594	0.117	-79.613
1850	0.413	-121.692	3.654	103.215	0.119	-27.518	0.115	-82.165
1900	0.416	-124.469	3.633	101.291	0.119	-28.483	0.113	-84.722
1950	0.419	-127.201	3.613	99.367	0.120	-29.461	0.111	-87.462
2000	0.422	-130.044	3.592	97.431	0.120	-30.414	0.110	-90.359
2050	0.425	-132.901	3.570	95.510	0.120	-31.362	0.108	-93.223
2100	0.428	-135.666	3.547	93.588	0.120	-32.353	0.106	-96.005
2150	0.432	-138.396	3.525	91.656	0.120	-33.317	0.104	-99.124
2160	0.433	-138.893	3.519	91.287	0.120	-33.518	0.104	-99.644
2170	0.434	-139.420	3.515	90.904	0.120	-33.707	0.103	-100.212
2180	0.434	-139.934	3.509	90.532	0.120	-33.908	0.103	-100.854
2190	0.435	-140.473	3.506	90.142	0.120	-34.094	0.103	-101.491

(continued)

MMH3111NT1

50 OHM TYPICAL CHARACTERISTICS

Table 11. Common Source S-Parameters ($V_{DD} = 5 \text{ Vdc}$, $I_{DD} = 150 \text{ mA}$, $T_A = 25^\circ\text{C}$, 50 Ohm System) (continued)

f MHz	S ₁₁		S ₂₁		S ₁₂		S ₂₂	
	S ₁₁	∠ φ	S ₂₁	∠ φ	S ₁₂	∠ φ	S ₂₂	∠ φ
2200	0.436	-141.015	3.502	89.764	0.120	-34.293	0.102	-102.102
2250	0.440	-143.664	3.480	87.853	0.120	-35.279	0.100	-105.319
2300	0.444	-146.130	3.456	85.964	0.120	-36.278	0.099	-108.673
2350	0.448	-148.573	3.433	84.098	0.120	-37.227	0.097	-111.868
2400	0.452	-150.891	3.408	82.262	0.120	-38.193	0.094	-115.093
2450	0.457	-153.231	3.384	80.399	0.120	-39.165	0.093	-118.343
2500	0.461	-155.588	3.360	78.562	0.120	-40.131	0.091	-121.666
2550	0.465	-157.929	3.337	76.708	0.120	-41.119	0.090	-125.028
2600	0.469	-160.182	3.312	74.886	0.120	-42.109	0.089	-128.277
2650	0.473	-162.557	3.290	73.042	0.120	-43.087	0.088	-131.582
2700	0.476	-164.863	3.268	71.221	0.120	-44.100	0.088	-134.657
2750	0.480	-167.206	3.246	69.393	0.120	-45.119	0.087	-137.722
2800	0.483	-169.520	3.223	67.572	0.120	-46.143	0.087	-140.631
2850	0.487	-171.820	3.201	65.747	0.120	-47.132	0.086	-143.444
2900	0.490	-173.992	3.180	63.945	0.120	-48.134	0.086	-146.347
2950	0.494	-176.195	3.157	62.155	0.120	-49.132	0.085	-149.433
3000	0.498	-178.278	3.136	60.357	0.120	-50.131	0.085	-152.745
3050	0.501	179.789	3.114	58.599	0.120	-51.092	0.085	-156.274
3100	0.505	177.950	3.092	56.836	0.120	-52.074	0.084	-160.030
3150	0.508	176.155	3.071	55.112	0.120	-53.076	0.085	-163.912
3200	0.511	174.401	3.051	53.377	0.120	-54.062	0.085	-167.662
3250	0.514	172.667	3.031	51.656	0.120	-55.020	0.085	-171.336
3300	0.517	170.842	3.010	49.907	0.120	-55.996	0.086	-175.010
3350	0.519	169.000	2.990	48.184	0.120	-56.970	0.087	-178.505
3400	0.522	167.181	2.970	46.458	0.120	-57.975	0.087	177.850
3450	0.524	165.308	2.950	44.716	0.120	-59.010	0.089	174.447
3500	0.527	163.438	2.930	43.003	0.120	-60.024	0.090	170.925
3550	0.528	161.590	2.911	41.291	0.120	-61.051	0.093	167.846
3600	0.531	159.691	2.892	39.560	0.120	-62.060	0.095	164.966

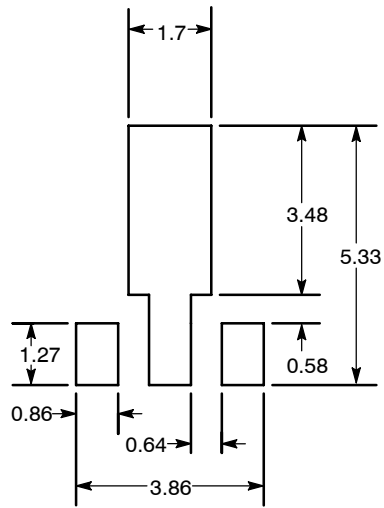

Recommended Solder Stencil

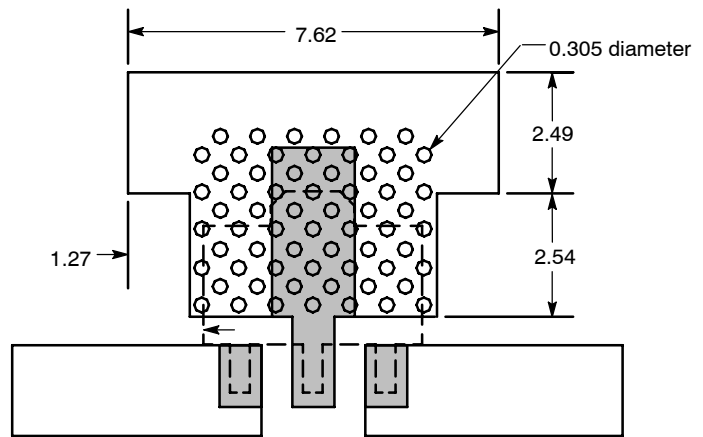

NOTES:

1. THERMAL AND RF GROUNDING CONSIDERATIONS SHOULD BE USED IN PCB LAYOUT DESIGN.
2. DEPENDING ON PCB DESIGN RULES, AS MANY VIAS AS POSSIBLE SHOULD BE PLACED ON THE LANDING PATTERN.
3. IF VIAS CANNOT BE PLACED ON THE LANDING PATTERN, THEN AS MANY VIAS AS POSSIBLE SHOULD BE PLACED AS CLOSE TO THE LANDING PATTERN AS POSSIBLE FOR OPTIMAL THERMAL AND RF PERFORMANCE.
4. RECOMMENDED VIA PATTERN SHOWN HAS 0.381 x 0.762 MM PITCH.

Figure 23. Recommended Mounting Configuration

PACKAGE DIMENSIONS

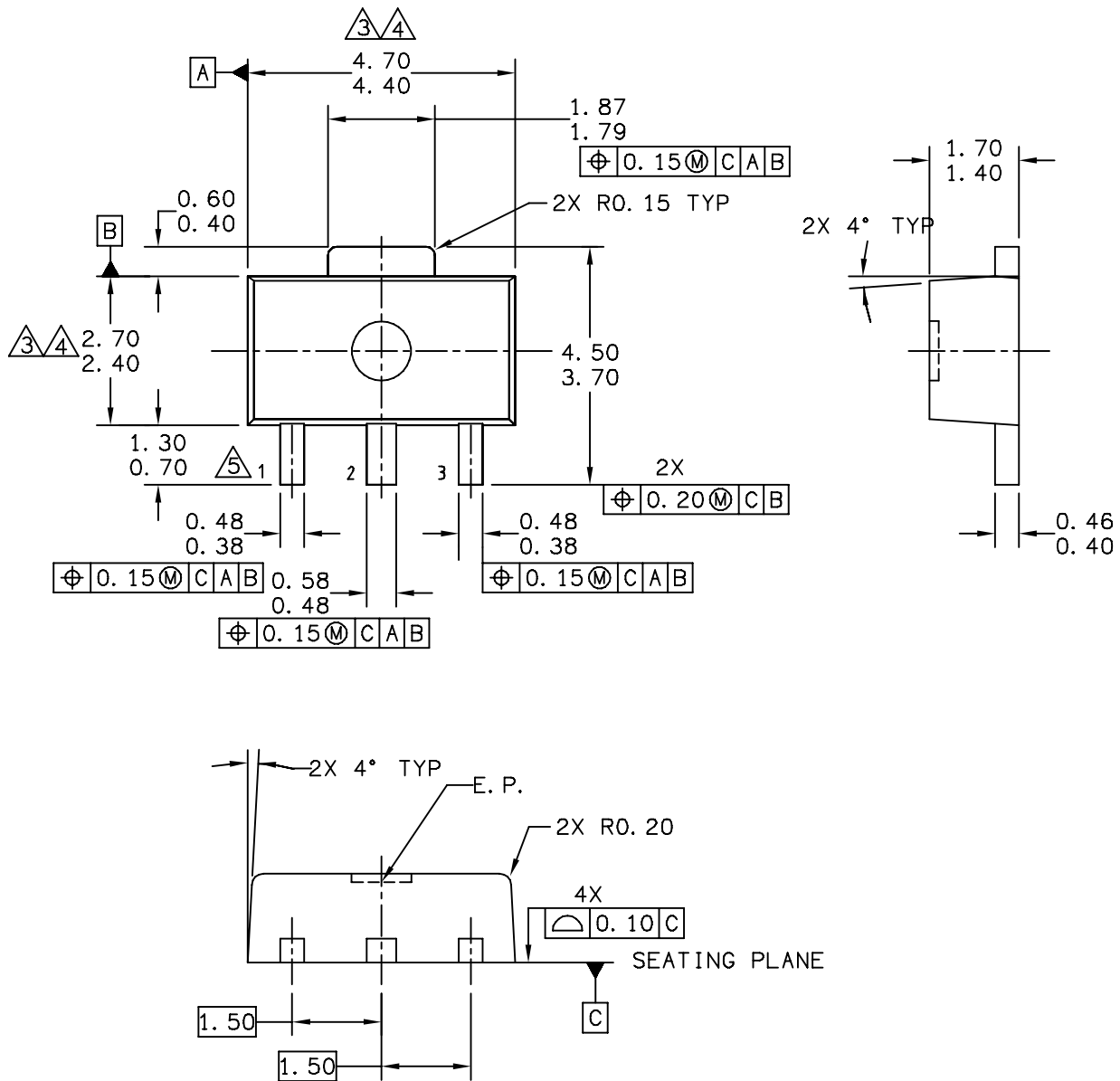

© FREESCALE SEMICONDUCTOR, INC. ALL RIGHTS RESERVED.	MECHANICAL OUTLINE	PRINT VERSION NOT TO SCALE	
TITLE: SOT-89, 4 LEAD, 4.5 X 2.5 PKG, 1.5 MM PITCH	DOCUMENT NO: 98ASA10586D	REV: D	
	CASE NUMBER: 1514-02	27 JUN 2007	
	STANDARD: NON-JEDEC		

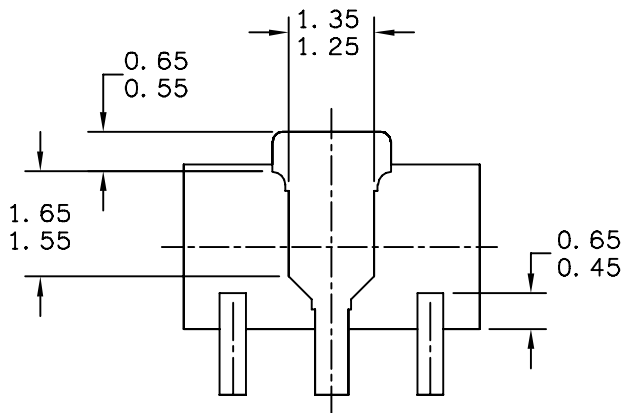

BOTTOM VIEW

CASE STYLE:

STYLE 1:
 PIN 1. RF INPUT
 PIN 2. GROUND
 PIN 3. RF OUTPUT

STYLE 2:
 PIN 1. GATE
 PIN 2. SOURCE
 PIN 3. DRAIN

© FREESCALE SEMICONDUCTOR, INC. ALL RIGHTS RESERVED.	MECHANICAL OUTLINE	PRINT VERSION NOT TO SCALE	
TITLE: SOT-89, 4 LEAD, 4.5 X 2.5 PKG, 1.5 MM PITCH	DOCUMENT NO: 98ASA10586D	REV: D	
	CASE NUMBER: 1514-02	27 JUN 2007	
	STANDARD: NON-JEDEC		

NOTES:

1 DIMENSIONING AND TOLERANCING PER ASME Y14.5M – 1994.

2 ALL DIMENSIONS ARE IN MILLIMETERS.

3 DIMENSIONS DOES NOT INCLUDE MOLD FLASH, PROTRUSIONS OR GATE BURRS. MOLD FLASH, PROTRUSIONS OR GATE BURRS SHALL NOT EXCEED 0.5mm PER END. DIMENSION DOES NOT INCLUDE INTERLEAD FLASH OR PROTRUSION. INTERLEAD FLASH OR PROTRUSION SHALL NOT EXCEED 0.5 mm PER SIDE.

4 DIMENSION ARE DETERMINED AT THE OUTMOST EXTREMES OF THE PLASTIC BODY EXCLUSIVE OF MOLD FLASH, TIE BAR BURRS, GATE BURRS AND INTERLEAD FLASH, BUT INCLUDING ANY MISMATCH BETWEEN THE TOP AND BOTTOM OF THE PLASTIC BODY.

5 TERMINAL NUMBERS ARE SHOWN FOR REFERENCE ONLY.

© FREESCALE SEMICONDUCTOR, INC. ALL RIGHTS RESERVED.	MECHANICAL OUTLINE	PRINT VERSION NOT TO SCALE	
TITLE: SOT-89, 4 LEAD, 4.5 X 2.5 PKG, 1.5 MM PITCH	DOCUMENT NO: 98ASA10586D	REV: D	
	CASE NUMBER: 1514-02	27 JUN 2007	
	STANDARD: NON-JEDEC		

PRODUCT DOCUMENTATION AND SOFTWARE

Refer to the following documents and software to aid your design process.

Application Notes

- AN1955: Thermal Measurement Methodology of RF Power Amplifiers

Software

- .s2p File

For Software, do a Part Number search at <http://www.freescale.com>, and select the “Part Number” link. Go to the Software & Tools tab on the part’s Product Summary page to download the respective tool.

REVISION HISTORY

The following table summarizes revisions to this document.

Revision	Date	Description
0	Nov. 2007	<ul style="list-style-type: none">• Initial Release of Data Sheet
1	Apr. 2008	<ul style="list-style-type: none">• Removed Footnote 2, Continuous voltage and current applied to device, from Table 2, Maximum Ratings, p. 1• Corrected Fig. 13, Single-Carrier W-CDMA Adjacent Channel Power Ratio versus Output Power y-axis (ACPR) unit of measure to dBc, p. 5• Updated Part Numbers in Tables 8, 9, 10, Component Designations and Values, to latest RoHS compliant part numbers, p. 6, 7, 8
2	Apr. 2010	<ul style="list-style-type: none">• Changed Maximum Ratings table value for RF input power from 10 to 20 dBm as a result of improvements made in the measurement method and the capability of the device, p. 1• Added .s2p File availability to Product Software, p. 15

How to Reach Us:

Home Page:

www.freescale.com

Web Support:

<http://www.freescale.com/support>

USA/Europe or Locations Not Listed:

Freescale Semiconductor, Inc.
Technical Information Center, EL516
2100 East Elliot Road
Tempe, Arizona 85284
1-800-521-6274 or +1-480-768-2130
www.freescale.com/support

Europe, Middle East, and Africa:

Freescale Halbleiter Deutschland GmbH
Technical Information Center
Schatzbogen 7
81829 Muenchen, Germany
+44 1296 380 456 (English)
+46 8 52200080 (English)
+49 89 92103 559 (German)
+33 1 69 35 48 48 (French)
www.freescale.com/support

Japan:

Freescale Semiconductor Japan Ltd.
Headquarters
ARCO Tower 15F
1-8-1, Shimo-Meguro, Meguro-ku,
Tokyo 153-0064
Japan
0120 191014 or +81 3 5437 9125
support.japan@freescale.com

Asia/Pacific:

Freescale Semiconductor China Ltd.
Exchange Building 23F
No. 118 Jianguo Road
Chaoyang District
Beijing 100022
China
+86 10 5879 8000
support.asia@freescale.com

For Literature Requests Only:

Freescale Semiconductor Literature Distribution Center
1-800-441-2447 or +1-303-675-2140
Fax: +1-303-675-2150
LDCForFreescaleSemiconductor@hibbertgroup.com

Information in this document is provided solely to enable system and software implementers to use Freescale Semiconductor products. There are no express or implied copyright licenses granted hereunder to design or fabricate any integrated circuits or integrated circuits based on the information in this document.

Freescale Semiconductor reserves the right to make changes without further notice to any products herein. Freescale Semiconductor makes no warranty, representation or guarantee regarding the suitability of its products for any particular purpose, nor does Freescale Semiconductor assume any liability arising out of the application or use of any product or circuit, and specifically disclaims any and all liability, including without limitation consequential or incidental damages. "Typical" parameters that may be provided in Freescale Semiconductor data sheets and/or specifications can and do vary in different applications and actual performance may vary over time. All operating parameters, including "Typicals", must be validated for each customer application by customer's technical experts. Freescale Semiconductor does not convey any license under its patent rights nor the rights of others. Freescale Semiconductor products are not designed, intended, or authorized for use as components in systems intended for surgical implant into the body, or other applications intended to support or sustain life, or for any other application in which the failure of the Freescale Semiconductor product could create a situation where personal injury or death may occur. Should Buyer purchase or use Freescale Semiconductor products for any such unintended or unauthorized application, Buyer shall indemnify and hold Freescale Semiconductor and its officers, employees, subsidiaries, affiliates, and distributors harmless against all claims, costs, damages, and expenses, and reasonable attorney fees arising out of, directly or indirectly, any claim of personal injury or death associated with such unintended or unauthorized use, even if such claim alleges that Freescale Semiconductor was negligent regarding the design or manufacture of the part.

Freescale™ and the Freescale logo are trademarks of Freescale Semiconductor, Inc. All other product or service names are the property of their respective owners.

© Freescale Semiconductor, Inc. 2007-2008, 2010. All rights reserved.

