

## Data Sheet

### Description

The MSA-0505 is a high performance medium power silicon bipolar Monolithic Microwave Integrated Circuit (MMIC) housed in a low cost, surface mount package. This MMIC is designed for use as a general purpose 50 $\Omega$  gain block. Typical applications include narrow and broad band IF and RF amplifiers in commercial systems.

The MSA-series is fabricated using Avago's 10 GHz  $f_T$ , 25 GHz  $f_{MAX}$ , silicon bipolar MMIC process which uses nitride self-alignment, ion implantation, and gold metallization to achieve excellent performance, uniformity and reliability. The use of an external bias resistor for temperature and current stability also allows bias flexibility.

### 05 Plastic Package

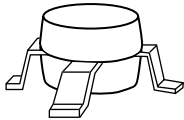

### Features

- Cascadable 50  $\Omega$  Gain Block
- High Output Power:  
18.0 dBm Typical  $P_1$  dB at 1.0 GHz
- Low Distortion:  
29.0 dBm Typical  $IP_3$  at 1.0 GHz
- 7.0 dB Typical Gain at 1.0 GHz
- Surface Mount Plastic Package
- Tape-and-Reel Packaging Option Available
- Lead-free Option Available

### Typical Biasing Configuration

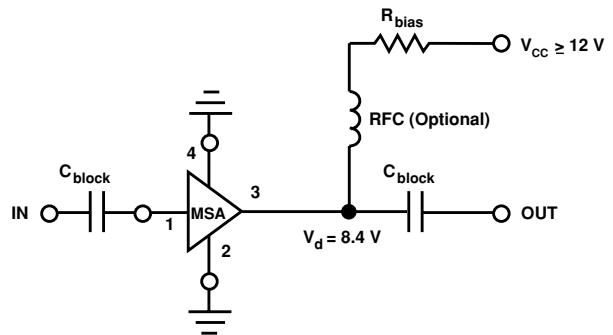

## MSA-0505 Absolute Maximum Ratings

Parameter	Absolute Maximum <sup>[1]</sup>
Device Current	135 mA
Power Dissipation <sup>[2,3]</sup>	1.5 W
RF Input Power	+25 dBm
Junction Temperature	200°C
Storage Temperature	-65 to 150°C

## Thermal Resistance<sup>[2]</sup>:

$$\theta_{jc} = 85^{\circ}\text{C/W}$$

Notes:

1. Permanent damage may occur if any of these limits are exceeded.
2.  $T_{\text{CASE}} = 25^{\circ}\text{C}$ .
3. Derate at 11.8 mW/°C for  $T_{\text{C}} > 73^{\circ}\text{C}$ .

## Electrical Specifications<sup>[1]</sup>, $T_{\text{A}} = 25^{\circ}\text{C}$

Symbol	Parameters and Test Conditions: $I_{\text{d}} = 80 \text{ mA}$ , $Z_0 = 50 \Omega$	Units	Min.	Typ.	Max.	
$P_{1 \text{ dB}}$	Output Power at 1 dB Gain Compression	$f = 0.5 \text{ GHz}$			19.0	
		$f = 1.0 \text{ GHz}$	dBm	16.0	18.0	
$G_{\text{p}}$	Power Gain ( $ S_{21} ^2$ )	$f = 0.5 \text{ GHz}$			7.5	
		$f = 1.0 \text{ GHz}$	dB	6.0	7.0	
$\Delta G_{\text{p}}$	Gain Flatness	$f = 0.1 \text{ to } 1.5 \text{ GHz}$			$\pm 0.75$	
$f_{3 \text{ dB}}$	3 dB Bandwidth <sup>[2]</sup>				2.3	
VSWR	Input VSWR	$f = 0.1 \text{ to } 1.5 \text{ GHz}$			1.6:1	
	Output VSWR	$f = 0.1 \text{ to } 1.5 \text{ GHz}$			2.0:1	
$IP_3$	Third Order Intercept Point	$f = 1.0 \text{ GHz}$			29.0	
NF	50 $\Omega$ Noise Figure	$f = 1.0 \text{ GHz}$			6.5	
$t_{\text{D}}$	Group Delay	$f = 1.0 \text{ GHz}$			190	
$V_{\text{d}}$	Device Voltage		V	6.7	8.4	10.1
$dV/dT$	Device Voltage Temperature Coefficient		mV/°C		-16.0	

Notes:

1. The recommended operating current range for this device is 60 to 100 mA. Typical performance as a function of current is on the following page.
2. Referenced from 0.1 GHz Gain (GP).

## Ordering Information

Part Numbers	No. of Devices	Comments
MSA-0505-STR	10	Bulk
MSA-0505-STRG	100	Bulk
MSA-0505-TR1	500	7" Reel
MSA-0505-TR1G	500	7" Reel

Note: Order part number with a "G" suffix if lead-free option is desired.

### MSA-0505 Typical Scattering Parameters ( $T_A = 25^\circ\text{C}$ , $I_d = 80\text{ mA}$ )

Freq. MHz	$S_{11}$			$S_{21}$			$S_{12}$		$S_{22}$		k
	Mag	Ang	dB	Mag	Ang	dB	Mag	Ang	Mag	Ang	
5	.56	-39	14.9	5.56	161	-18.5	.120	39	.65	-36	0.60
25	.24	-103	9.7	3.05	156	-13.9	.202	12	.25	-90	0.97
50	.15	-130	8.2	2.57	163	-13.7	.207	7	.15	-116	1.15
100	.13	-155	7.8	2.45	165	-13.7	.207	3	.11	-132	1.21
200	.12	-170	7.7	3.43	161	-13.5	.211	1	.11	-145	1.21
400	.12	178	7.5	2.37	148	-13.6	.209	-1	.14	-146	1.23
600	.13	172	7.4	2.34	134	-13.6	.209	-2	.17	-151	1.23
800	.13	168	7.2	2.29	119	-13.6	.209	-3	.21	-157	1.23
1000	.14	166	7.0	2.24	105	-13.4	.213	-4	.25	-164	1.21
1500	.21	159	6.4	2.09	72	-13.3	.217	-6	.34	176	1.16
2000	.30	148	5.2	1.82	42	-13.1	.222	-9	.42	159	1.12
2500	.40	136	4.1	1.60	17	-12.9	.227	-11	.48	146	1.05
3000	.52	121	2.7	1.36	-7	-12.6	.234	-16	.55	133	0.92

### Typical Performance, $T_A = 25^\circ\text{C}$

(unless otherwise noted)

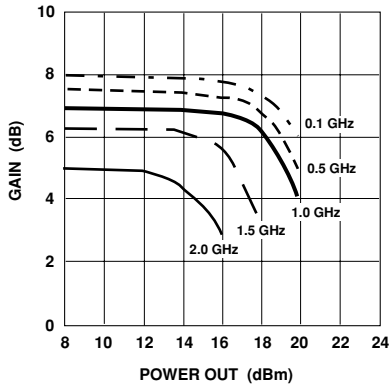

Figure 1. Typical Gain vs. Power Out,  $T_A = 25^\circ\text{C}$ ,  $I_d = 80\text{ mA}$ .

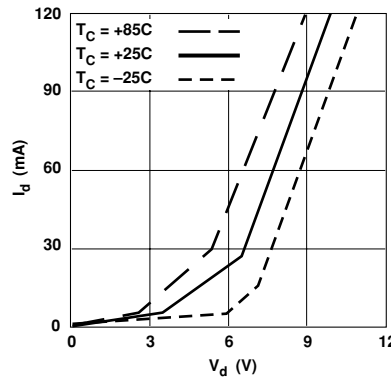

Figure 2. Device Current vs. Voltage.

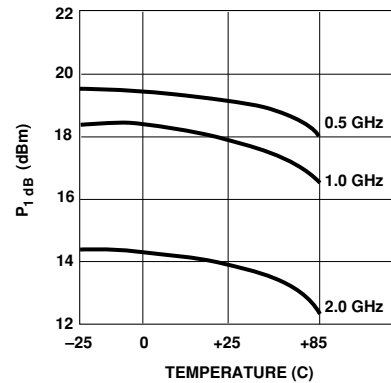

Figure 3. Output Power at 1 dB Gain Compression, vs. Case Temperature,  $I_d = 80\text{ mA}$ .

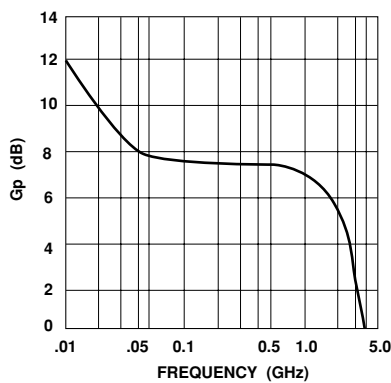

Figure 4. Gain vs. Frequency,  $I_d = 80$  to  $100\text{ mA}$ .

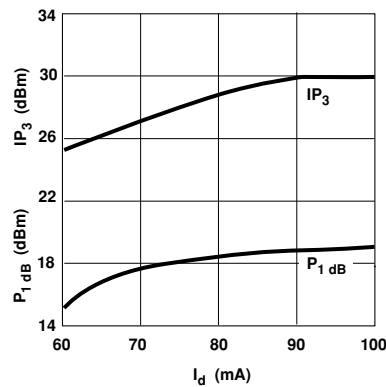
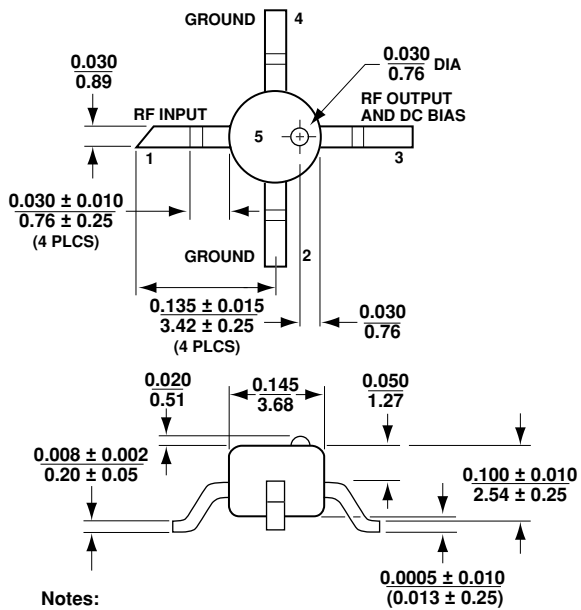

Figure 5. Output Power at 1 dB Gain Compression, Third Order Intercept vs. Case Temperature,  $f = 1.0\text{ GHz}$ .

## 05 Plastic Package Dimensions



### Notes:

(unless otherwise specified)

1. Dimensions are  $\frac{\text{in}}{\text{mm}}$

2. Tolerances

in .xxx = 0.005

mm .xx = 0.13

For product information and a complete list of distributors, please go to our web site: [www.avagotech.com](http://www.avagotech.com)

Avago, Avago Technologies, and the A logo are trademarks of Avago Technologies, Limited in the United States and other countries. Data subject to change. Copyright © 2008 Avago Technologies, Limited. All rights reserved. Obsoletes 5989-2754EN AV02-1227EN May 14, 2008

**AVAGO**  
TECHNOLOGIES