



Product Description

RFMD's SZA-3044 is a high linearity class AB Heterojunction Bipolar Transistor (HBT) amplifier housed in a low-cost surface-mountable plastic package. This HBT amplifier is made with InGaP on GaAs device technology and fabricated with MOCVD for an ideal combination of low cost and high reliability. This product is specifically designed as a final or driver stage for 802.16 equipment in the 3.3GHz to 3.8GHz bands. It can run from a 3V to 6V supply. Optimized on-chip impedance matching circuitry provides a 50Ω nominal RF input impedance. The external output match and bias adjustability allows load line optimization for other applications or over narrower bands. It features an output power detector, on/off power control and high RF overdrive robustness. This product is available in a RoHS Compliant and Green package with matte tin finish, designated by the "Z" package suffix.

Optimum Technology Matching® Applied

- GaAs HBT
- GaAs MESFET
- InGaP HBT
- SiGe BiCMOS
- Si BiCMOS
- SiGe HBT
- GaAs pHEMT
- Si CMOS
- Si BJT
- GaN HEMT
- RF MEMS

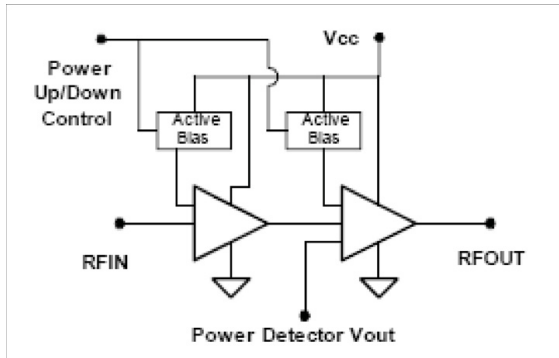

Features

- P_{1dB} = 31 dBm at 5V
- 802.11a 54 Mb/s 2.5% EVM Performance
- P_{OUT} = 24 dBm, V_{CC} = 5V, 340 mA, PAE 14.5%
- P_{OUT} = 25 dBm, V_{CC} = 6V, 365 mA, PAE 14.5%
- On-Chip Output Power Detector
- Robust - Survives RF Input Power = +15 dBm
- On Chip ESD Protection Class 2 (2000V)
- Power Up/Down Control < 1μs
- Pin Compatible With SZA-2044 and SZA-5044

Applications

- 802.16 WiMAX Driver or Output Stage
- Fixed Wireless, WLL

Parameter	Specification			Unit	Condition
	Min.	Typ.	Max.		
Frequency of Operation	2700		3800	MHz	
Output Power at 1dB Compression ^[1]	29.5	31.0		dBm	3.3GHz
	28.5	30.0		dBm	3.6GHz
Small Signal Gain	22.0	24.0	26.0	dB	3.4GHz
	22.0	24.0	26.0	dB	3.6GHz
Output power		24.0		dBm	3.4GHz, 2.5% EVM 802.11a 54 Mb/s
Third Order Suppression		-38.5	-35.5	dBc	3.6GHz, P _{OUT} = 20dBm per tone
Noise Figure		5.0		dB	3.6GHz
Worst Case Input Return Loss	12.0	15.0		dB	3.3GHz to 3.8GHz
Worst Case Output Return Loss	7.0	10.0		dB	3.3GHz to 3.6GHz
Quiescent Current	170	205	240	mA	V _{CC} = 5V
Power Up Control Current		2.7		mA	V _{PC} = 5V, I _{VPC1} + I _{VPC2}
Off V _{CC} Leakage Current		10.0	100.0	uA	V _{PC} = 0V
Thermal Resistance		22		°C/W	junction - lead

Test Conditions: Z₀ = 50Ω, V_{CC} = 5V, I_Q = 205 mA, T_{BP} = 30 °C

Absolute Maximum Ratings

Parameter	Rating	Unit
VC2 Collector Bias Current (I_{VC2})	600	mA
VC1 Collector Bias Current (I_{VC1})	300	mA
Device Voltage (V_D), No RF drive	7	V
Power Dissipation	3.5	W
Max RF Input Power for 50Ω output load	15	dBm
Max RF Input Power for 10:1 VSWR RF out load	8	dBm
Junction Temp (T_J)	+150	°C
Operating Temp Range (T_L)	-40 to +85	°C
Storage Temp Range	-40 to +150	°C
ESD Rating - Human Body Model (HBM)	2000	V
Moisture Sensitivity Level	MSL-1	



Caution! ESD sensitive device.

Exceeding any one or a combination of the Absolute Maximum Rating conditions may cause permanent damage to the device. Extended application of Absolute Maximum Rating conditions to the device may reduce device reliability. Specified typical performance or functional operation of the device under Absolute Maximum Rating conditions is not implied.

RoHS status based on EUDirective2002/95/EC (at time of this document revision).

The information in this publication is believed to be accurate and reliable. However, no responsibility is assumed by RF Micro Devices, Inc. ("RFMD") for its use, nor for any infringement of patents, or other rights of third parties, resulting from its use. No license is granted by implication or otherwise under any patent or patent rights of RFMD. RFMD reserves the right to change component circuitry, recommended application circuitry and specifications at any time without prior notice.

Operation of this device beyond any one of these limits may cause permanent damage. For reliable continuous operation, the device voltage and current must not exceed the maximum operating values specified in the table on page one.

Bias Conditions should also satisfy the following expression:

$$I_D V_D < (T_J - T_L) / R_{TH, j-H} \text{ and } T_L = T_{LEAD}$$

Typical Performance, 3.2GHz to 3.6GHz Application Circuit ($V_{CC}=5V$, $I_{CQ}=220mA$, 802.11a 54Mb/s 64QAM)

Parameter	Units	3.2GHz	3.3GHz	3.4GHz	3.5GHz	3.6GHz	3.7GHz
Gain @ $P_{OUT}=24dBm$	dB	25.7	25.6	25.5	25.2	24.3	23.4
P_{1dB}	dBm	31.0	31.0	30.5	30.0	30.0	29.5
P_{OUT} 2.5% EVM*	dBm	23.5	24.0	24.0	23.5	23.0	23.0
I @ P_{OUT} 2.5% EVM*	mA	331	340	339	330	327	325

*See 3.0GHz to 3.6GHz Application Circuit

Typical Performance, 3.2GHz to 3.6GHz 6V Application Circuit ($V_{CC}=6V$, $I_{CQ}=220mA$, 802.11a 54Mb/s 64QAM)

Parameter	Units	3.3GHz	3.4GHz	3.5GHz	3.6GHz	3.7GHz
Gain @ $P_{OUT}=24dBm$	dB	25.6	25.6	25.1	24.1	23.2
P_{1dB}	dBm	32.5	32.0	32.0	31.5	31.5
P_{OUT} 2.5% EVM*	dBm	25.0	25.0	25.0	24.5	24.5
I @ P_{OUT} 2.5% EVM*	mA	370	365	363	356	355

*Contact Applications Engineering for details about application circuit

Typical Performance, 3.4GHz to 3.7GHz 5V Application Circuit ($V_{CC}=5V, I_{CQ}=360mA, 802.11a$ 54 Mb/s 64QAM)

Parameter	Units	3.4GHz	3.5GHz	3.6GHz	3.7GHz	3.8GHz
Gain @ $P_{OUT} = 24dBm$	dB	24.5	24.2	23.6	22.7	21.5
P_{1dB}	dBm	31.5	31.5	31.0	31.0	30.0
P_{OUT} 2.5% EVM*	dBm	23.5	23.5	24.0	23.5	23.0
$I @ P_{OUT}$ 2.5% EVM*	mA	445	450	450	450	433

*Optimized for maximum P_{OUT} @ 2.5% EVM over 3.4GHz to 3.7GHz band. Same application circuit from Rev. B datasheet. Contact Applications Engineering for details.

Typical Performance, 2.7GHz to 3.0GHz 5V Application Circuit ($V_{CC}=5V, I_{CQ}=360mA, 802.11a$ 54 Mb/s 64QAM)

Parameter	Units	2.7GHz	2.8GHz	2.9GHz	3.0GHz
Gain @ $P_{OUT} = 24dBm$	dB	25.3	25.3	25.3	25.2
P_{1dB}	dBm	31.0	31.0	31.0	31.0
P_{OUT} 2.5% EVM*	dBm	23.0	23.5	23.5	23.5
$I @ P_{OUT}$ 2.5% EVM*	mA	438	453	450	444

*Contact Applications Engineering for details about application circuit

Simplified Device Schematic

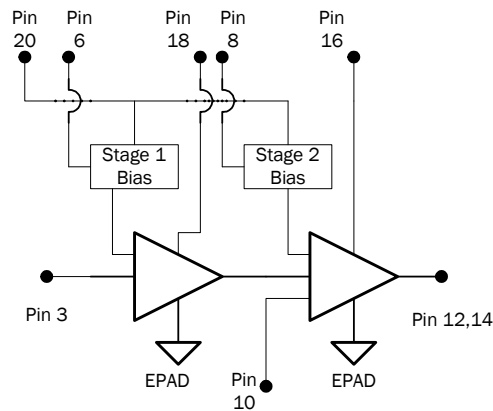

Measured 3.2GHz to 3.6GHz Application Circuit Data ($V_{CC}=V_{PC}=5.0V$ $I_Q=220mA$, $T=25^\circ C$)

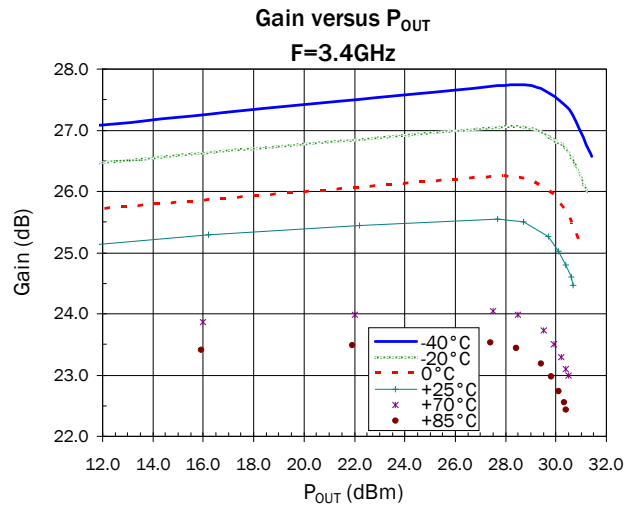
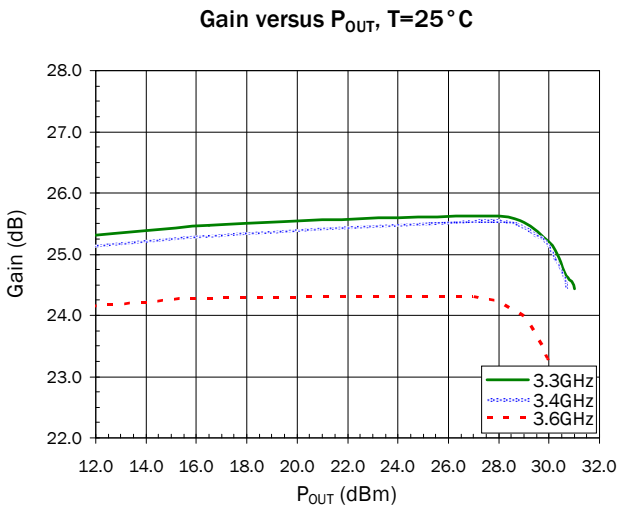
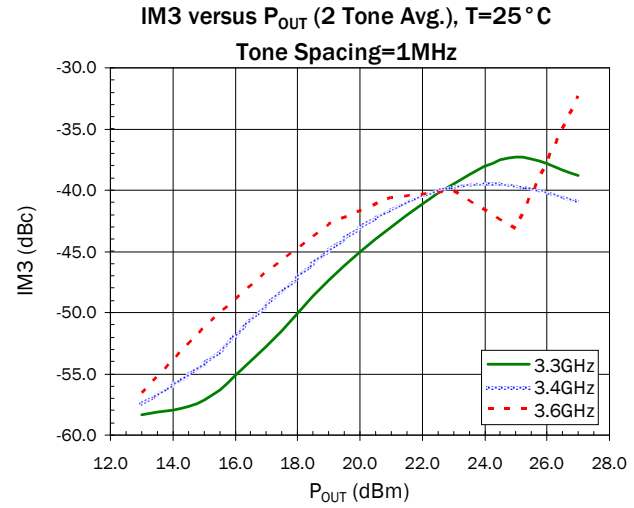
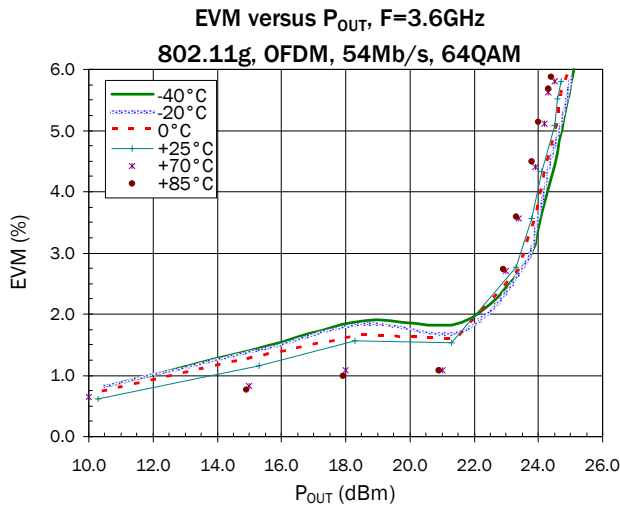
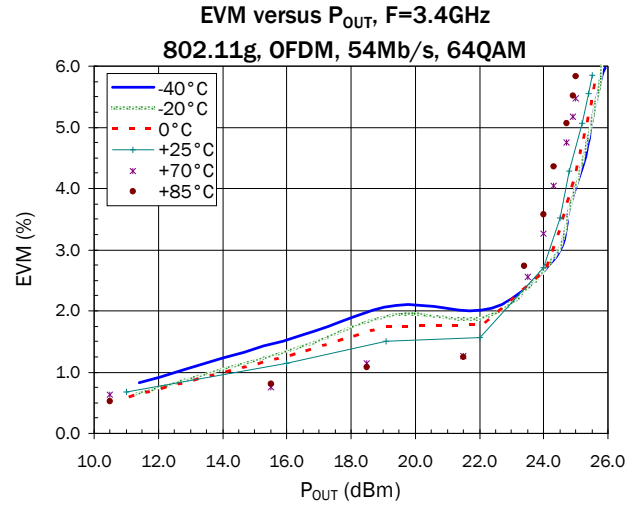
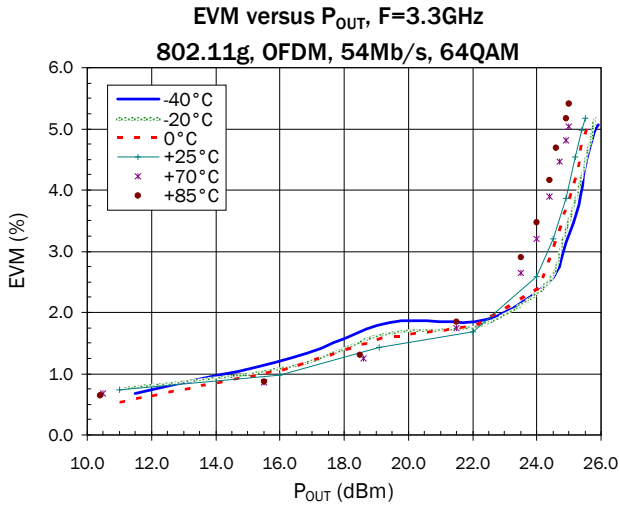

Measured 3.2GHz to 3.6GHz Application Circuit Data ($V_{CC}=V_{PC}=5.0V$ $I_Q=220mA$, $T=25^\circ C$)

Narrowband S11 - Input Return Loss

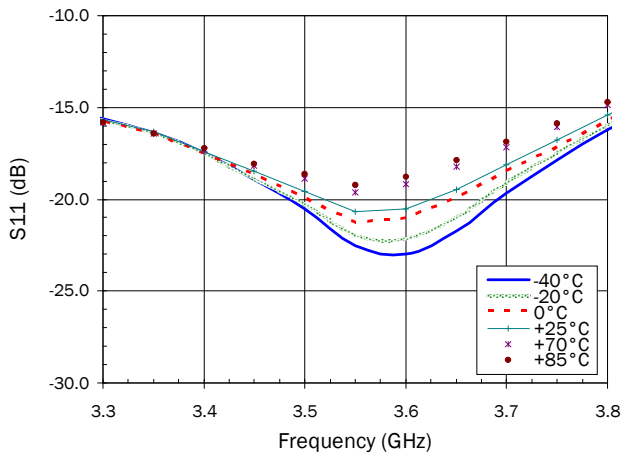

Narrowband S12 - Reverse Isolation

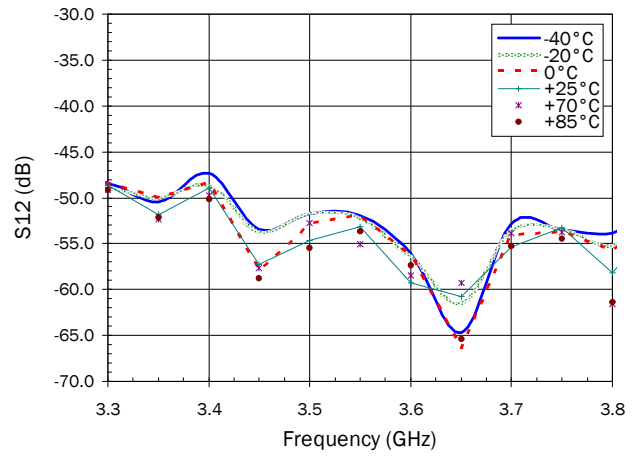

Narrowband S21 - Forward Gain

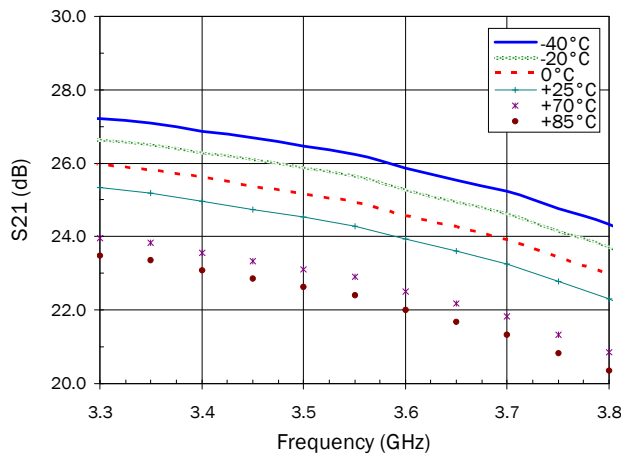

Narrowband S22 - Output Return Loss

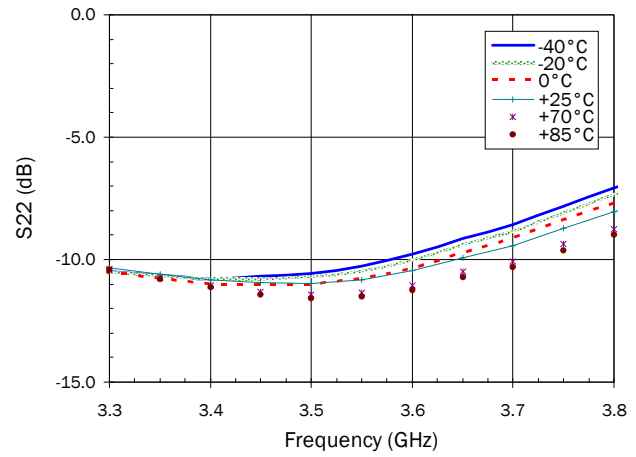

DC Supply Current (I_{DC}) versus P_{OUT} , $T=25^\circ C$

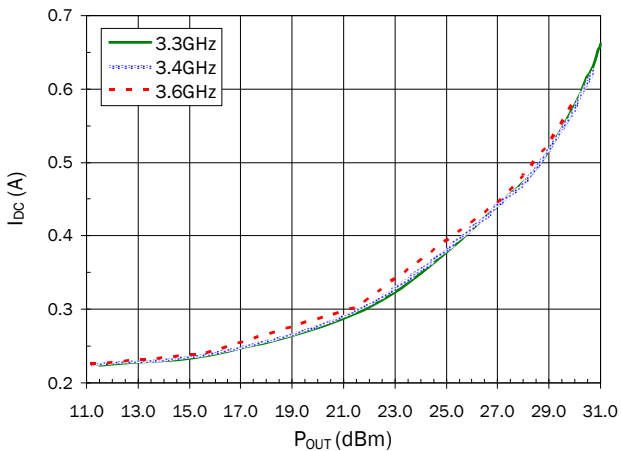

Noise Figure (NF) versus Frequency

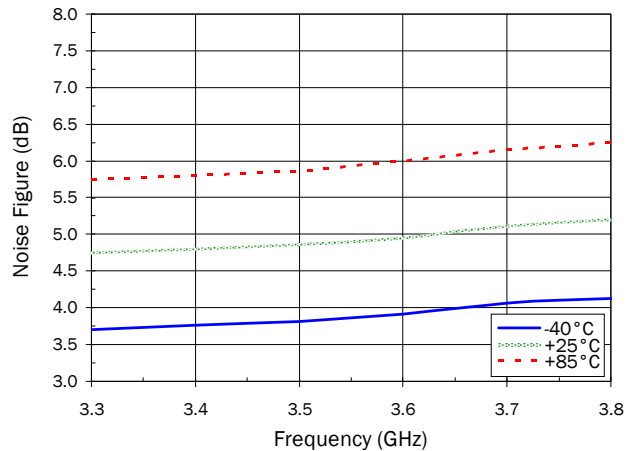

Measured 3.2GHz to 3.6GHz Application Circuit Data ($V_{CC}=V_{PC}=5.0V$ $I_Q=220mA$, $T=25^\circ C$)

RF Power Detector (V_{DET}) versus P_{OUT} , $T=25^\circ C$

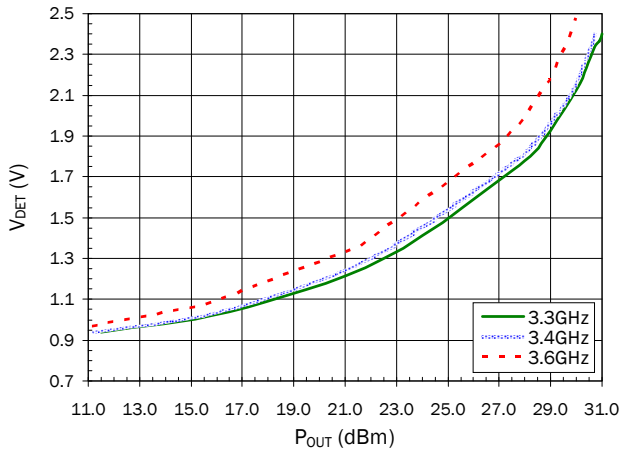

RF Power Detector (V_{DET}) versus P_{OUT}
 $F=3.4GHz$

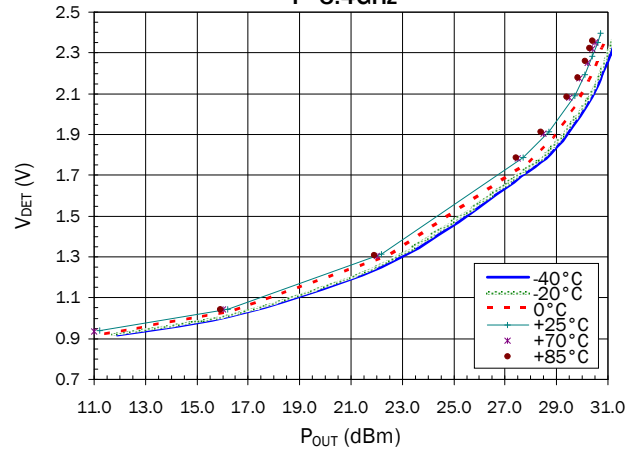

Broadband S11 - Input Return Loss

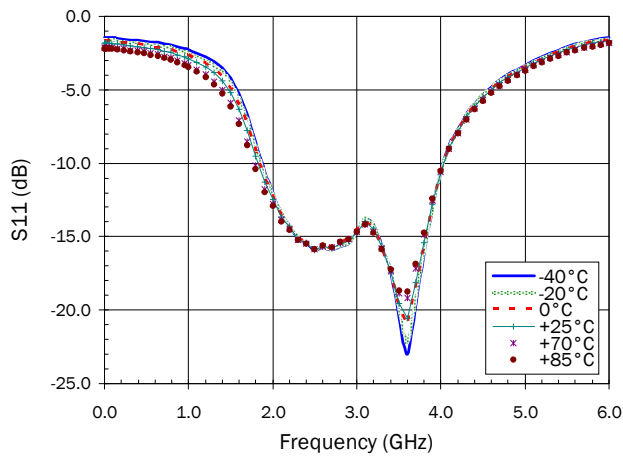

Broadband S12 - Reverse Isolation

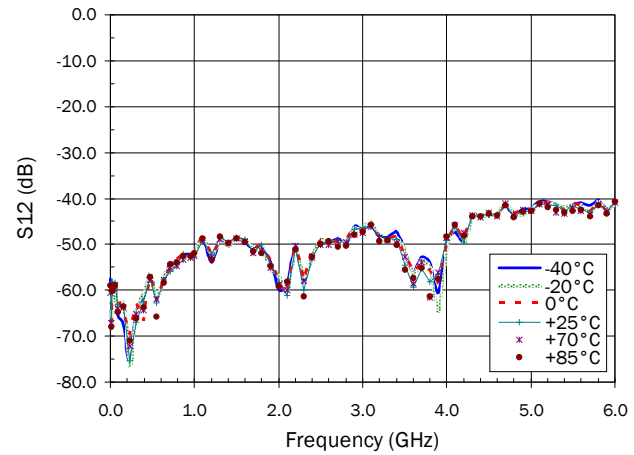

Broadband S21 - Forward Gain

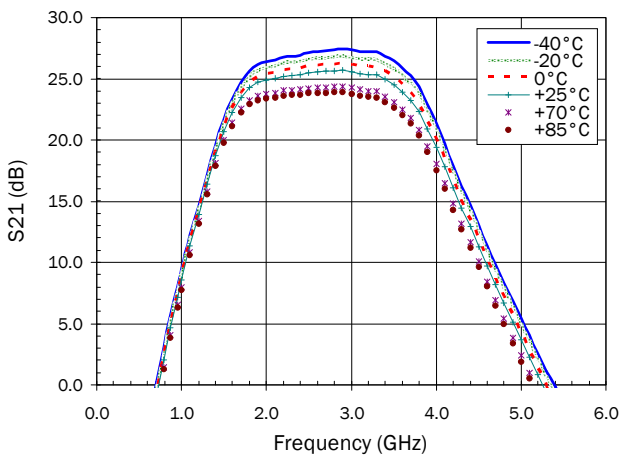

Broadband S22 - Output Return Loss

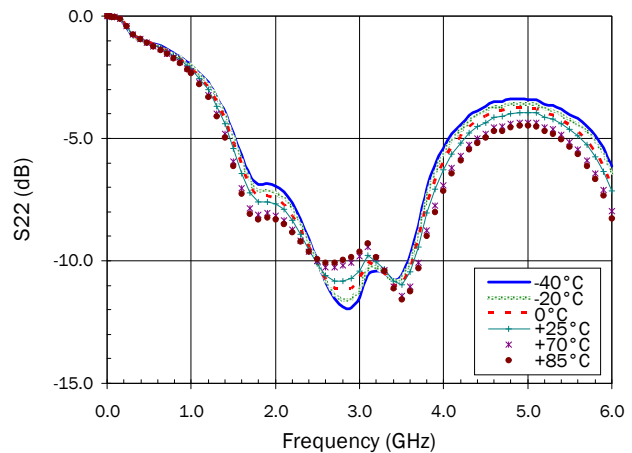

Pin	Function	Description
1, 2, 4, 5, 7, 9, 11, 13, 15, 17, 19	N/C	These are unused pins and not wired inside the package. They may be grounded or connected to adjacent pins.
6	VPC1	VPC1 is the bias control pin for the stage 1 active bias circuit. An external series resistor is required for proper setting of bias levels. Refer to the evaluation board schematic for resistor value. To prevent potential damage, do not apply voltage to this pin that is +1V greater than voltage applied to pin 20 (Vbias) unless Vpc supply current capability is less than 10mA.
8	VPC2	VPC2 is the bias control pin for the stage 2 active bias circuit. An external series resistor is required for proper setting of bias levels. Refer to the evaluation board schematic for resistor value. To prevent potential damage, do not apply voltage to this pin that is +1V greater than voltage applied to pin 20 (Vbias) unless Vpc supply current capability is less than 10mA.
10	VDET	Output power detector voltage. Load with > 10KΩ for best performance
3	RF IN	RF input pin. This is DC grounded internal to the IC. Do not apply voltage to this pin.
12, 14	RF OUT	RF output pin. This is also another connection to the 2nd stage collector.
16	VC2	2nd stage collector bias pin. Apply 3.0V to 5.0V to this pin.
18	VC1	1st stage collector bias pin. Apply 3.0V to 5.0V to this pin.
20	VBIAS	Active bias network VCC. Apply 3.0V to 5.0V to this pin.
EPAD	GND	Exposed area on the bottom side of the package needs to be soldered to the ground plane of the board for optimum thermal and RF performance. Several vias should be located under the EPAD as shown in the recommended land pattern.

Package Drawing

Dimensions in millimeters (inches)

Refer to drawing posted at www.rfmd.com for tolerances.

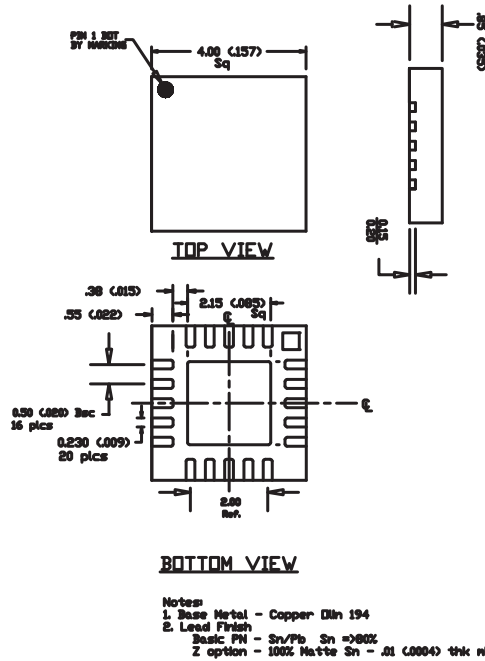

Part Symbolization

The part will be symbolized with an “SZA-3044” for Sn/Pb plating or “SZA-3044Z” for RoHS green compliant product. Marking designator will be on the top surface of the package.

3.2GHz to 3.6GHz Application Circuit

For $V_{CC}=V+=V_{PC}=5.0V$

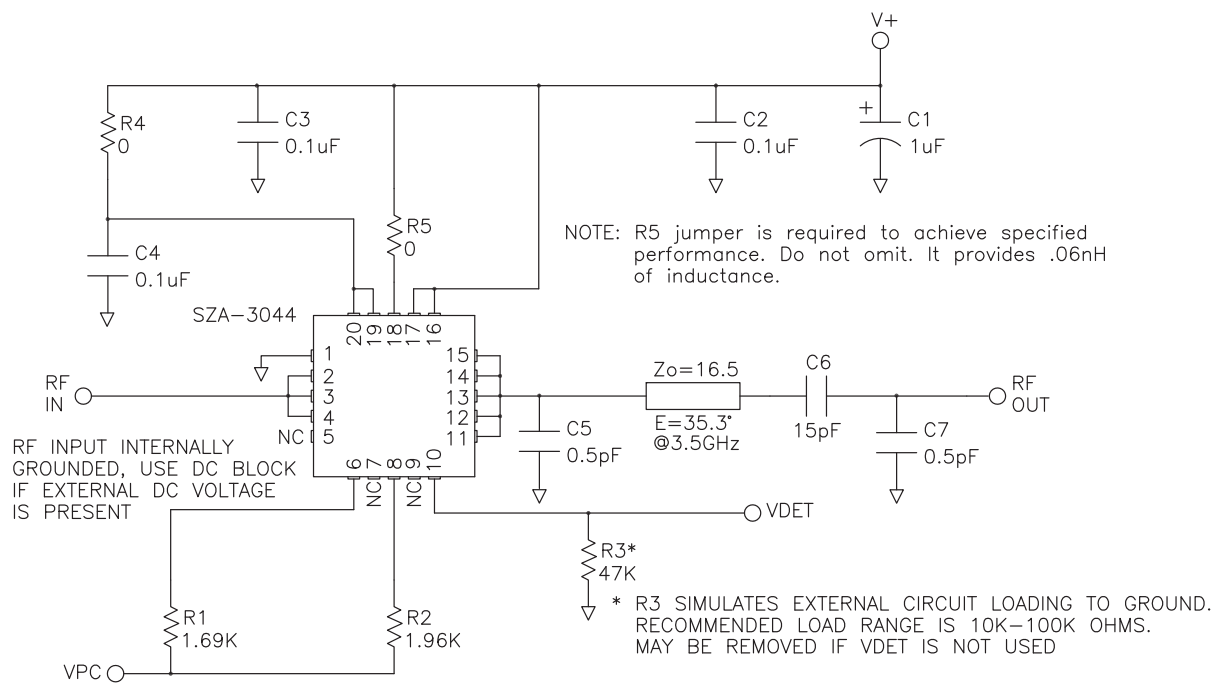

3.2GHz to 3.6GHz Evaluation Board Layout and Bill of Materials

For $V_{CC}=V+=V_{PC}=5.0V$

Board material GETEK, 10mil thick, Dk=3.9, 2oz. copper

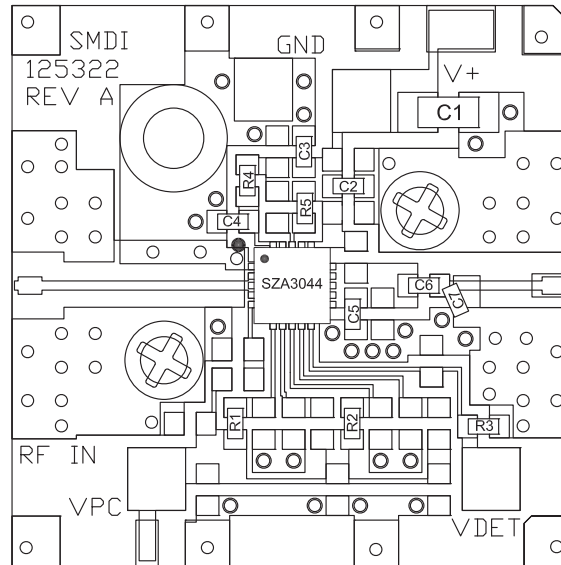

Bill of Materials

DESG	Description	Notes
Q1	SZA-3044	4x4 QFN
R1	1.69K Ω , 0603 1%	0402 may be used.
R2	1.96K Ω , 0603 1%	0402 may be used.
R3	47K Ω , 0603	0402 may be used.
R4, 5	0 Ω , 0603	0402 may be used.
C1	1uF 16V CAP	Tantulum ok for EVM performance. Use MLCC type for best IM3 levels.
C2, 3, 4	0.1uF CAP, 0603	X7R 0402 ok, ROHM MCH182CN104K or equiv.
C5, 7	0.5pF CAP, 0603	NPO type, ROHM MCH185A0R5CK or equiv.
C6	15 pF CAP, 0603	NPO, ROHM MCH185150JK or equiv.

Recommended Land Pattern

Dimensions in millimeters (inches)

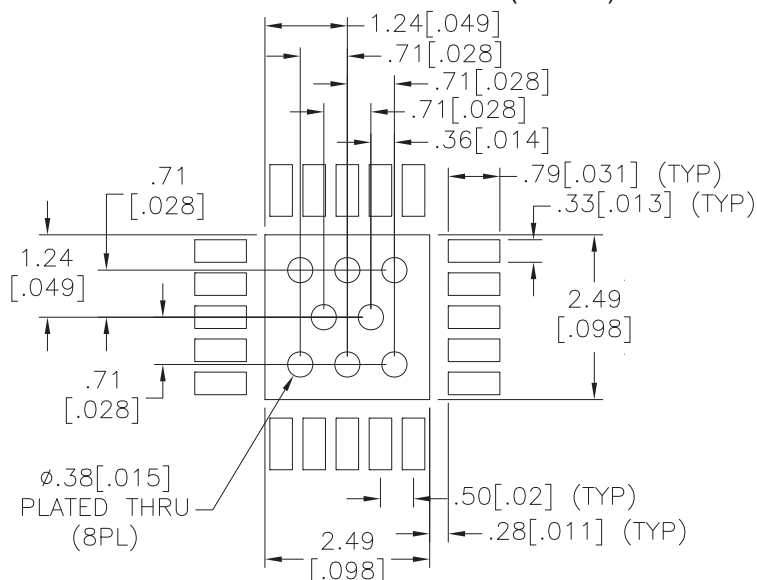

Recommended PCB Soldermask (SMBOC) for Land Pattern

Dimensions in millimeters (inches)

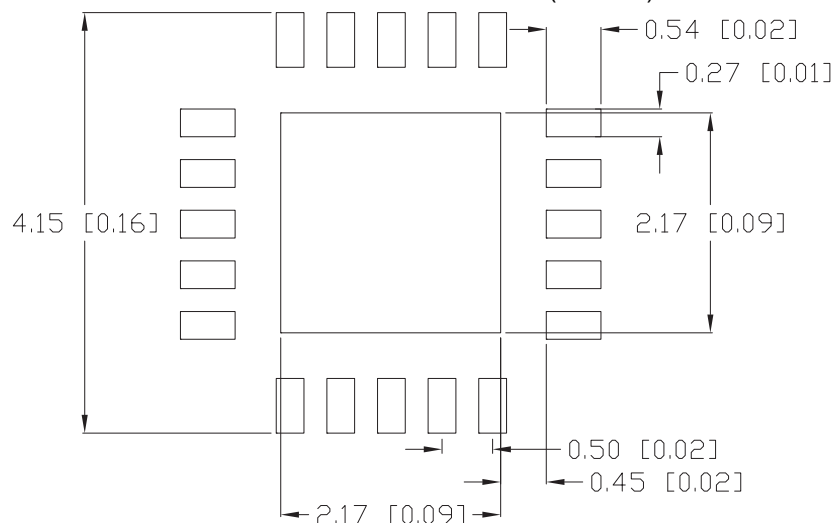

Ordering Information

Part Number	Description	Reel Size	Devices/Reel
SZA3044	Sn/Pb Plating	13"	3000
SZA3044Z	Lead Free, RoHS Compliant	13"	3000
SZA3044ZPCK-EVB1	Fully assembled evaluation board tuned for 3.2 to 3.6 GHz and 5 piece loose samples	N/A	N/A