



BIPOLAR ANALOG INTEGRATED CIRCUIT

μ PC8233TK

SiGe:C LOW NOISE AMPLIFIER FOR GPS/MOBILE COMMUNICATIONS

DESCRIPTION

The μ PC8233TK is a silicon germanium carbon (SiGe:C) monolithic integrated circuit designed as low noise amplifier for GPS and mobile communications. This device exhibits low noise figure and high power gain characteristics. This device is enabled in the frequency range from 1.5 to 2.4 GHz by modifying the external matching circuit.

This device is suitable for the reduction in power consumption of the mobile communication system because it operates by low voltage and low current.

The package is 6-pin lead-less minimold, suitable for surface mount.

This IC is manufactured using our UHS4 (Ultra High Speed Process) SiGe:C bipolar process.

FEATURES

- Supply voltage : $V_{CC} = 1.6$ to 3.3 V (2.7 V TYP.)
- Low noise : NF = 0.90 dB TYP. @ $V_{CC} = 2.7$ V, $f_{in} = 1.575$ MHz
NF = 0.90 dB TYP. @ $V_{CC} = 1.8$ V, $f_{in} = 1.575$ MHz
- High gain : $G_P = 20$ dB TYP. @ $V_{CC} = 2.7$ V, $f_{in} = 1.575$ MHz
 $G_P = 19.5$ dB TYP. @ $V_{CC} = 1.8$ V, $f_{in} = 1.575$ MHz
- Low current consumption : $I_{CC} = 3.5$ mA TYP. @ $V_{CC} = 2.7$ V
- Built-in power-saving function : $V_{PSON} = 1.0$ V to V_{CC} , $V_{PSOFF} = 0.0$ to 0.4 V
- High-density surface mounting : 6-pin lead-less minimold package ($1.5 \times 1.1 \times 0.55$ mm)
- Included very robust bandgap regulator (Small V_{CC} and T_A dependence)
- Included protection circuits for ESD

APPLICATION

- Low noise amplifier for GPS and mobile communications

ORDERING INFORMATION

Part Number	Order Number	Package	Marking	Supplying Form
μ PC8233TK-E2	μ PC8233TK-E2-A	6-pin lead-less minimold (1511 PKG) (Pb-Free)	6P	<ul style="list-style-type: none">• 8 mm wide embossed taping• Pin 1, 6 face the perforation side of the tape• Qty 5 kpcs/reel

Remark To order evaluation samples, contact your nearby sales office.

Part number for sample order: μ PC8233TK-a

Caution Observe precautions when handling because these devices are sensitive to electrostatic discharge.

The information in this document is subject to change without notice. Before using this document, please confirm that this is the latest version.

PIN CONNECTIONS

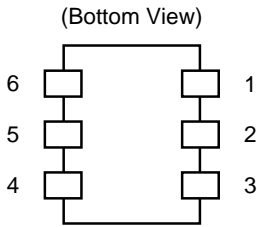
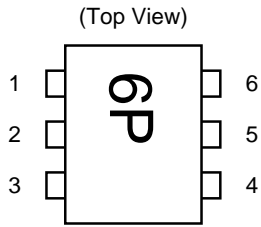

Pin No.	Pin Name
1	INPUT
2	GND
3	Power Save
4	OUTPUT
5	GND
6	V _{CC}

INTERNAL BLOCK DIAGRAM

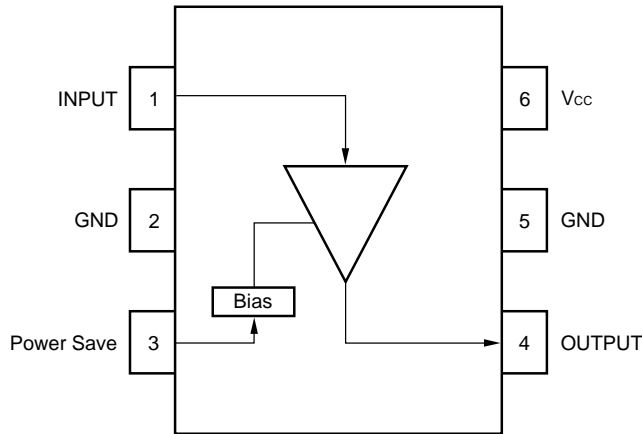

ABSOLUTE MAXIMUM RATINGS

Parameter	Symbol	Test Conditions	Ratings	Unit
Supply Voltage	V _{CC}	T _A = +25°C	4.0	V
Power-Saving Voltage	V _{PS}	T _A = +25°C	4.0	V
Power Dissipation	P _D	T _A = +85°C Note	232	mW
Operating Ambient Temperature	T _A		-40 to +85	°C
Storage Temperature	T _{stg}		-55 to +150	°C
Input Power	P _{in}		+10	dBm

Note Mounted on double-side copper-clad 50 × 50 × 1.6 mm epoxy glass PWB

RECOMMENDED OPERATING RANGE

Parameter	Symbol	MIN.	TYP.	MAX.	Unit
Supply Voltage	V _{CC}	1.6	2.7	3.3	V
Operating Ambient Temperature	T _A	-40	+25	+85	°C
Power Save Turn-on Voltage	V _{PSon}	1.0	-	V _{CC}	V
Power Save Turn-off Voltage	V _{PSoff}	0	-	0.4	V

ELECTRICAL CHARACTERISTICS

(TA = +25°C, VCC = VPS = 2.7 V, fin = 1 575 MHz, unless otherwise specified)

Parameter	Symbol	Test Conditions	MIN.	TYP.	MAX.	Unit
Circuit Current	I _{CC}	No Signal (V _{PS} = 2.7 V)	2.5	3.5	4.8	mA
		At Power-Saving Mode (V _{PS} = 0 V)	–	–	1	μA
Power Gain	G _P	P _{in} = –35 dBm	17.5	20.0	22.5	dB
Noise Figure	NF		–	0.9	1.2	dB
Input Return Loss	RL _{in}		7	10	–	dB
Output Return Loss	RL _{out}		10	16	–	dB

STANDARD CHARACTERISTICS FOR REFERENCE 1

(TA = +25°C, VCC = VPS = 2.7 V, fin = 1 575 MHz, unless otherwise specified)

Parameter	Symbol	Test Conditions	Reference	Unit
Input 3rd Order Intercept Point	IIP ₃	f _{in1} = 1 575 MHz, f _{in2} = 1 574 MHz	–8.5	dBm
Isolation	ISL		36	dB
Gain 1 dB Compression Input Power	P _{in (1 dB)}		–23	dBm

STANDARD CHARACTERISTICS FOR REFERENCE 2

(TA = +25°C, VCC = VPS = 1.8 V, fin = 1 575 MHz, unless otherwise specified)

Parameter	Symbol	Test Conditions	Reference	Unit
Circuit Current	I _{CC}	No Signal (V _{PS} = 1.8 V)	3.3	mA
Power Gain	G _P	P _{in} = –35 dBm	19.5	dB
Noise Figure	NF		0.9	dB
Input 3rd Order Intercept Point	IIP ₃	f _{in1} = 1 575 MHz, f _{in2} = 1 574 MHz	–9.5	dBm
Input Return Loss	RL _{in}		9.5	dB
Output Return Loss	RL _{out}		15.5	dB
Isolation	ISL		36	dB
Gain 1 dB Compression Input Power	P _{in (1 dB)}		–23.5	dBm

TEST CIRCUIT

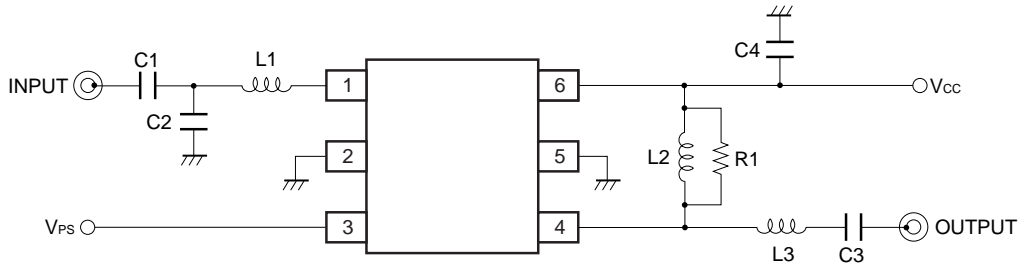

COMPONENT LIST

Symbol	Type	Value	Unit
C1	Chip Capacitor	1 000	pF
C2	Chip Capacitor	1.2	pF
C3	Chip Capacitor	18	pF
C4	Chip Capacitor	1 000	pF
L1	Chip Inductor	8.2	nH
L2	Chip Inductor	18	nH
L3	Chip Inductor	6.8	nH
R1	Chip Resistor	360	Ω

TYPICAL CHARACTERISTICS ($T_A = +25^\circ\text{C}$, unless otherwise specified)

CIRCUIT CURRENT vs. SUPPLY VOLTAGE

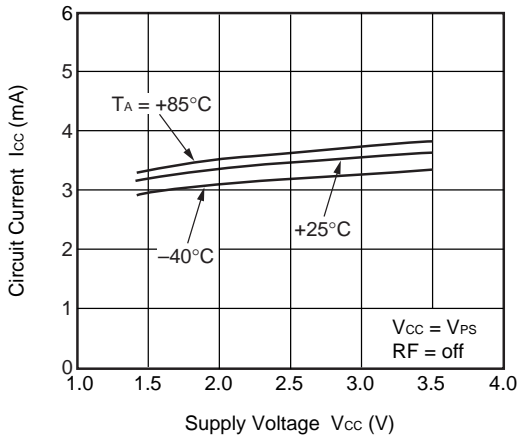

CIRCUIT CURRENT vs. POWER-SAVING VOLTAGE

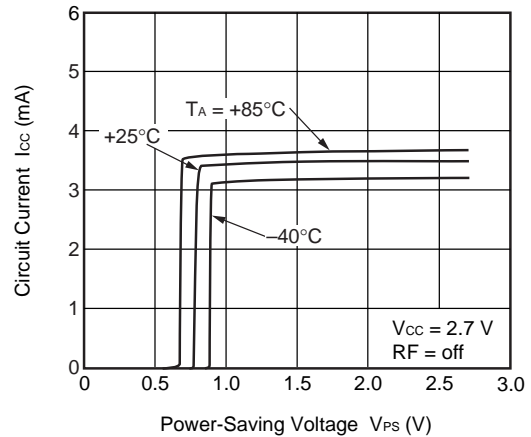

CIRCUIT CURRENT vs. POWER-SAVING VOLTAGE

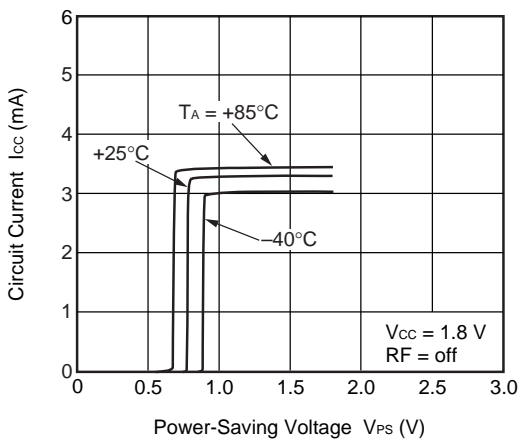

CIRCUIT CURRENT vs. OPERATING AMBIENT TEMPERATURE

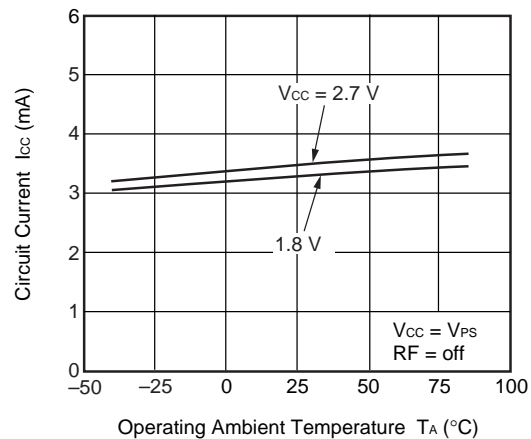

POWER GAIN vs. FREQUENCY

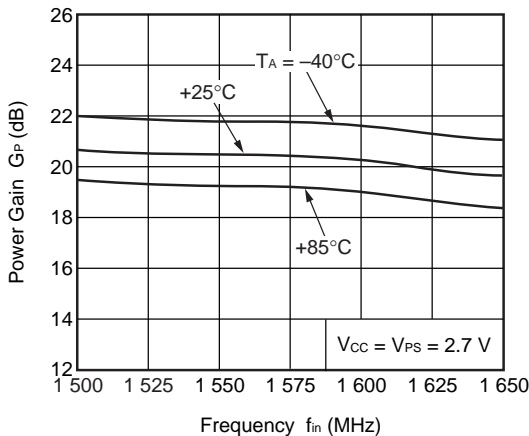

NOISE FIGURE vs. FREQUENCY

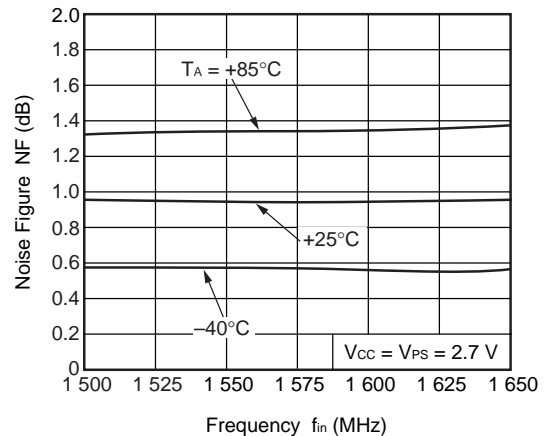

Remark The graphs indicate nominal characteristics.

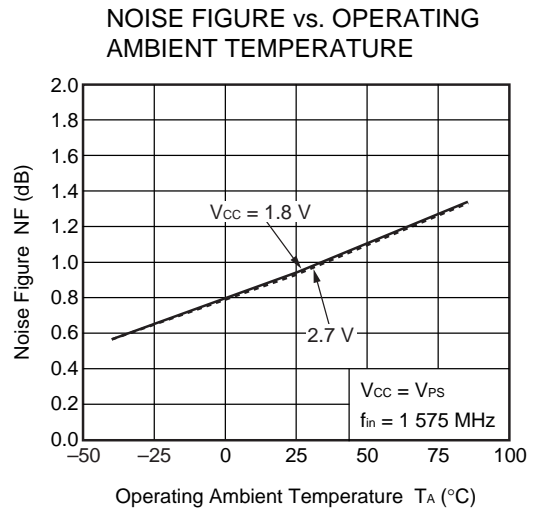
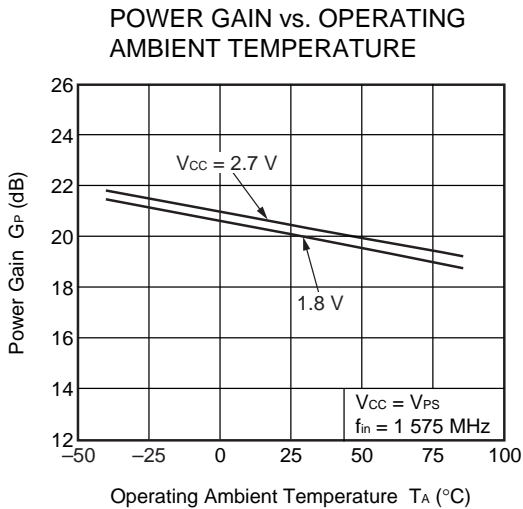
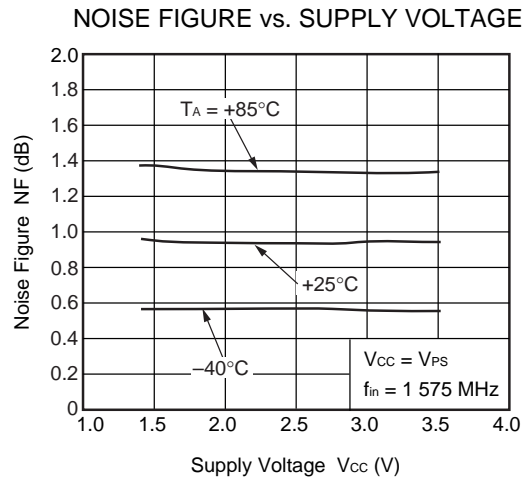
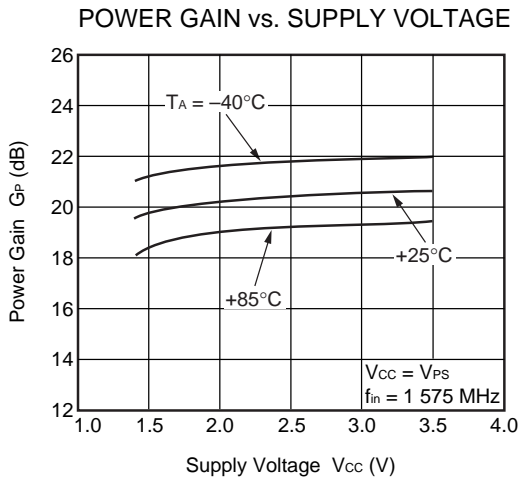
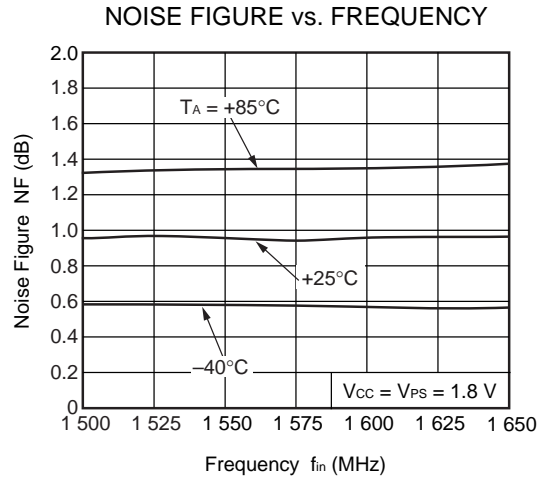
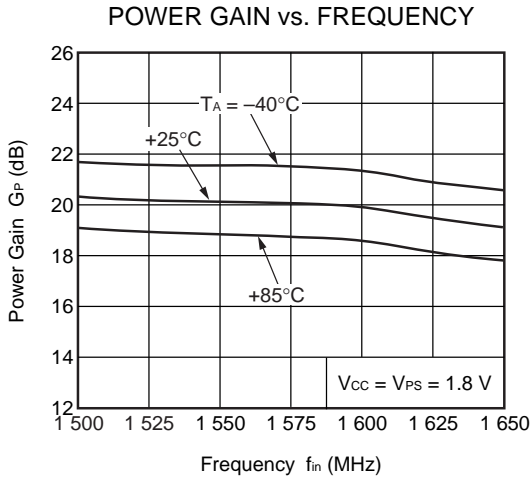

Remark The graphs indicate nominal characteristics.

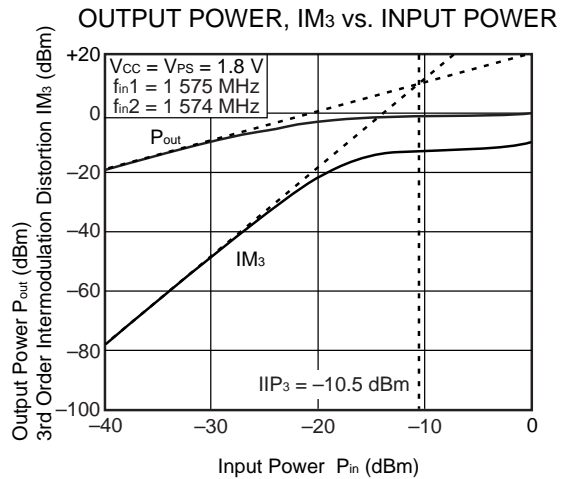
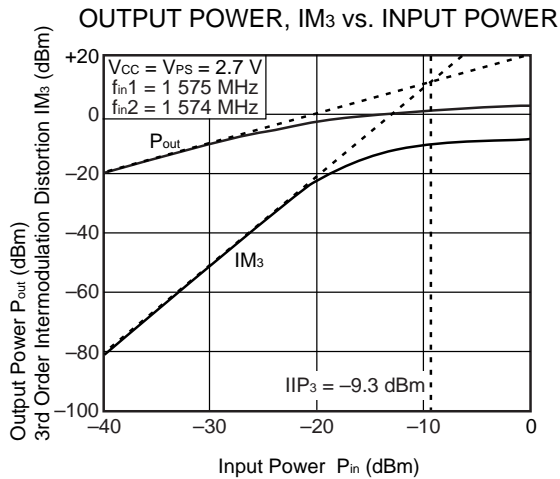
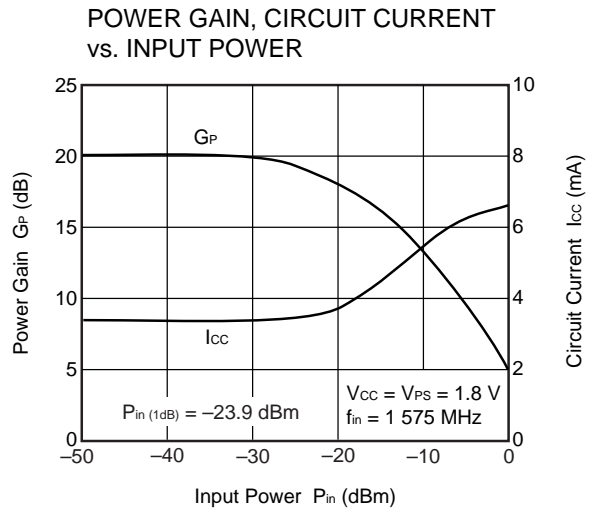
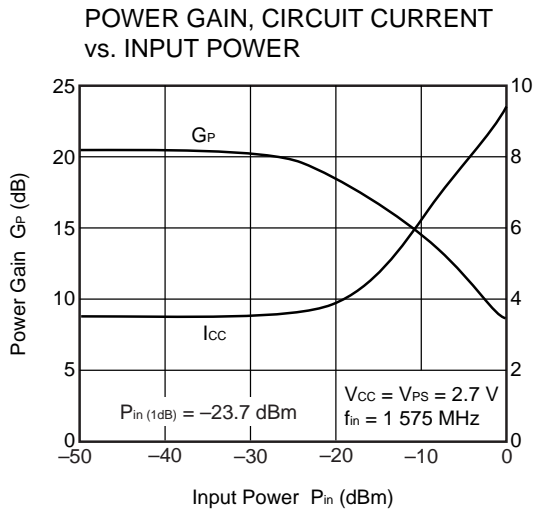
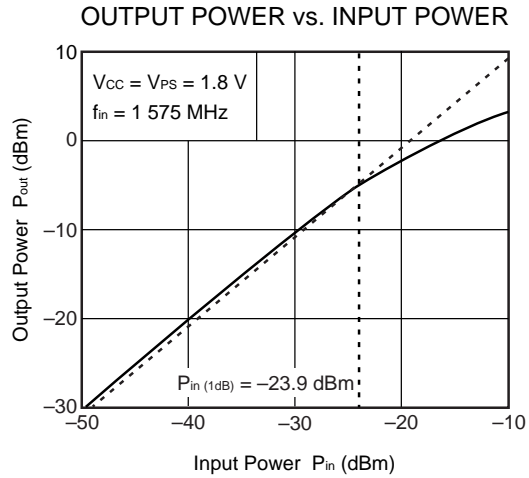
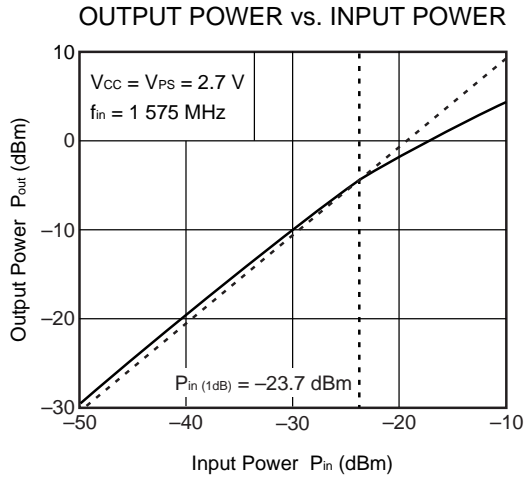

Remark The graphs indicate nominal characteristics.

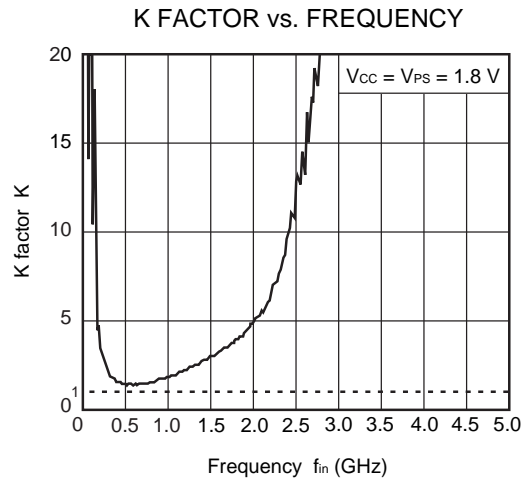
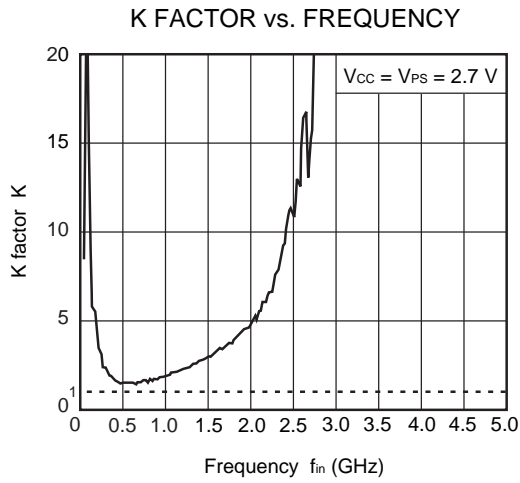
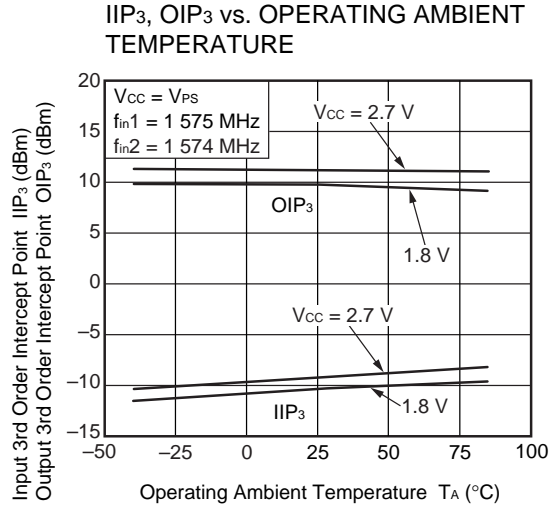
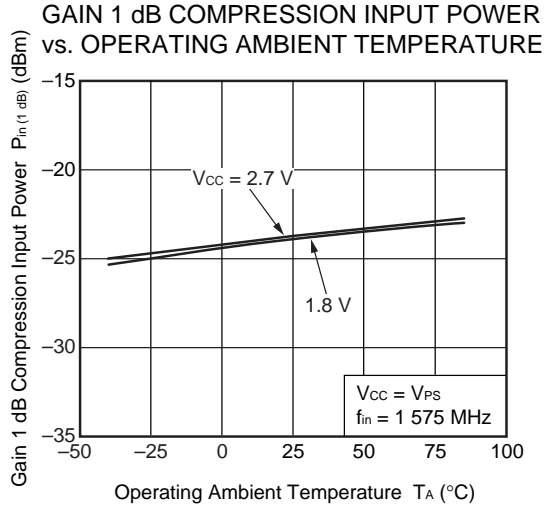

Remark The graphs indicate nominal characteristics.

S-PARAMETERS (T_A = +25°C, V_{CC} = V_{PS} = 2.7 V, monitored at connector on board)

S₁₁-FREQUENCY

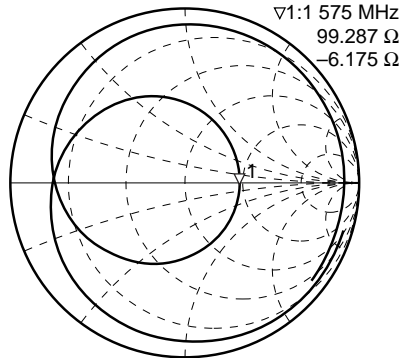

START 100.000 000 MHz STOP 4 100.000 000 MHz

S₂₂-FREQUENCY

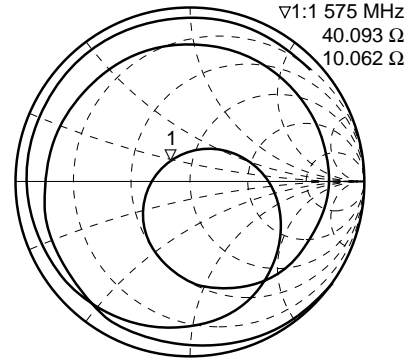

START 100.000 000 MHz STOP 4 100.000 000 MHz

INPUT RETURN LOSS vs. FREQUENCY

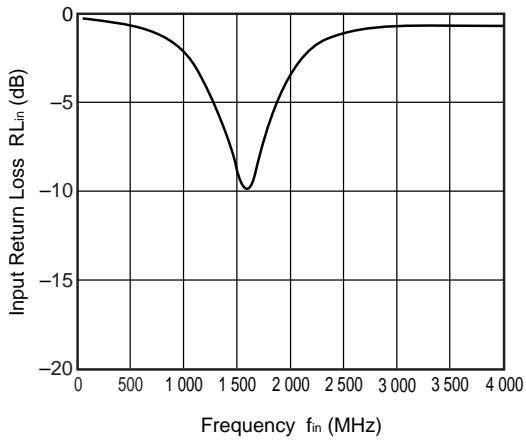

OUTPUT RETURN LOSS vs. FREQUENCY

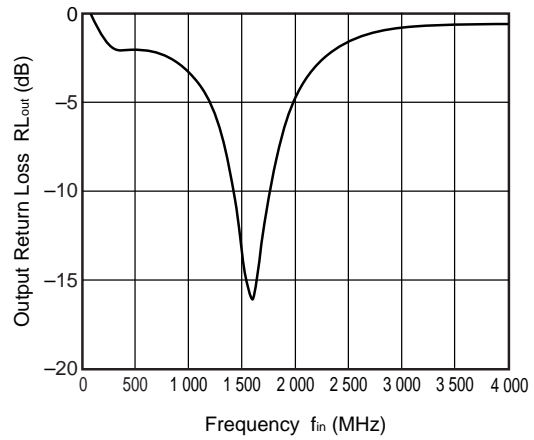

POWER GAIN vs. FREQUENCY

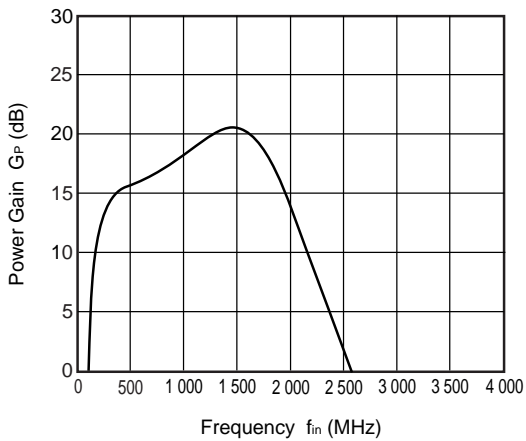

ISOLATION vs. FREQUENCY

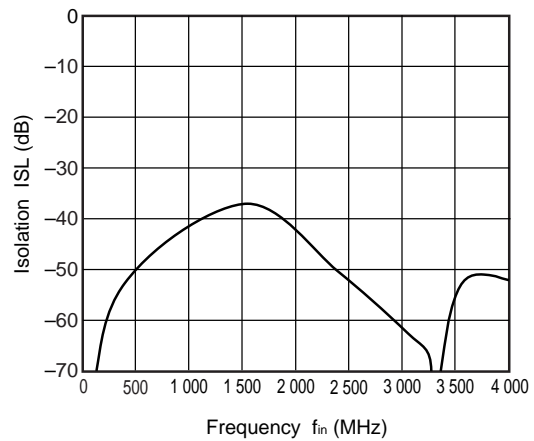

Remark The graphs indicate nominal characteristics.

S-PARAMETERS (T_A = +25°C, V_{CC} = V_{PS} = 1.8 V, monitored at connector on board)

S₁₁-FREQUENCY

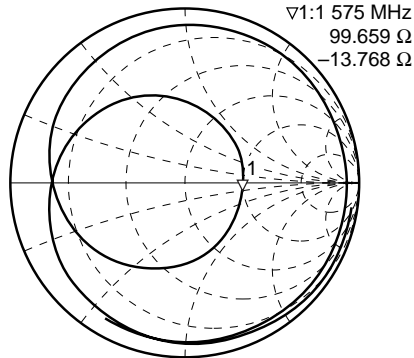

START 100.000 000 MHz STOP 4 100.000 000 MHz

S₂₂-FREQUENCY

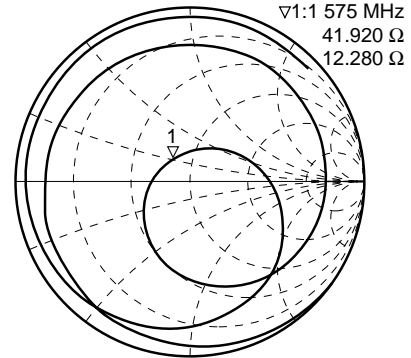

START 100.000 000 MHz STOP 4 100.000 000 MHz

INPUT RETURN LOSS vs. FREQUENCY

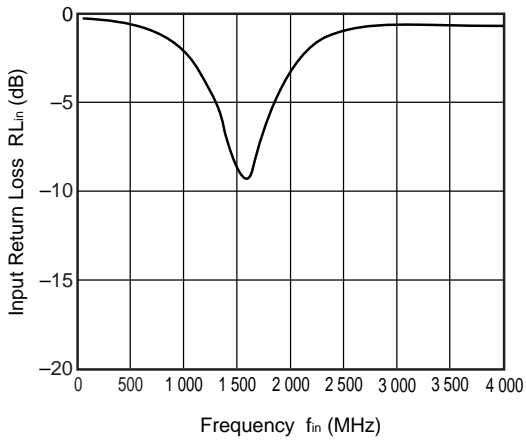

OUTPUT RETURN LOSS vs. FREQUENCY

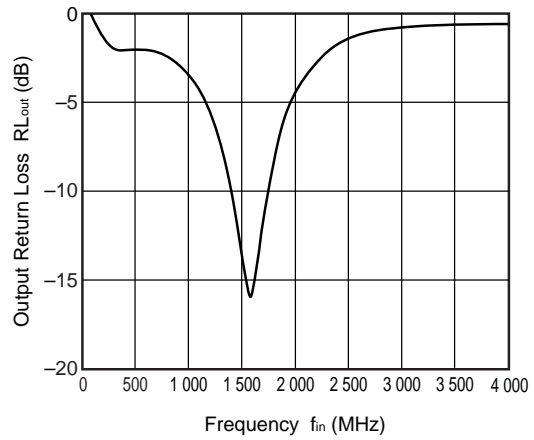

POWER GAIN vs. FREQUENCY

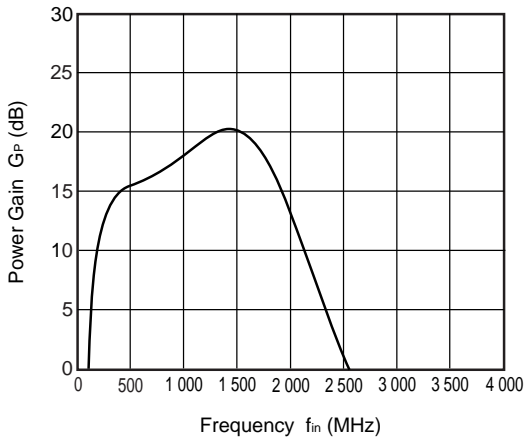

ISOLATION vs. FREQUENCY

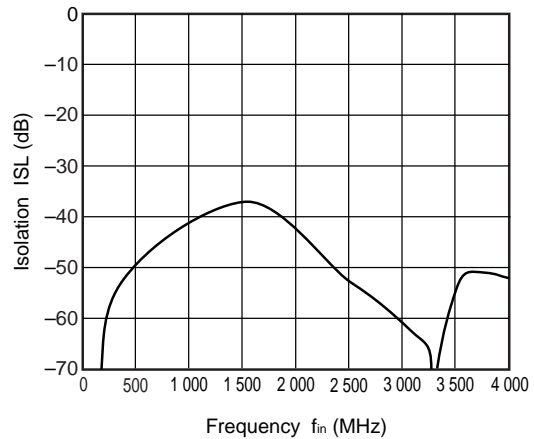

Remark The graphs indicate nominal characteristics.

PACKAGE DIMENSIONS

6-PIN LEAD-LESS MINIMOLD (1511 PKG) (UNIT: mm)

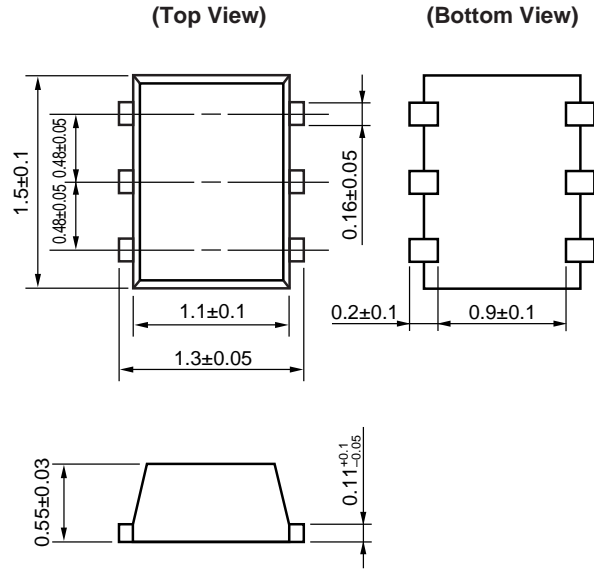

NOTES ON CORRECT USE

- (1) Observe precautions for handling because of electro-static sensitive devices.
- (2) Form a ground pattern as widely as possible to minimize ground impedance (to prevent undesired oscillation).
All the ground terminals must be connected together with wide ground pattern to decrease impedance difference.
- (3) The bypass capacitor should be attached to Vcc line.
- (4) Do not supply DC voltage to INPUT pin.

RECOMMENDED SOLDERING CONDITIONS

This product should be soldered and mounted under the following recommended conditions. For soldering methods and conditions other than those recommended below, contact your nearby sales office.

Soldering Method	Soldering Conditions	Condition Symbol
Infrared Reflow	Peak temperature (package surface temperature) : 260°C or below Time at peak temperature : 10 seconds or less Time at temperature of 220°C or higher : 60 seconds or less Preheating time at 120 to 180°C : 120±30 seconds Maximum number of reflow processes : 3 times Maximum chlorine content of rosin flux (% mass) : 0.2%(Wt.) or below	IR260
Wave Soldering	Peak temperature (molten solder temperature) : 260°C or below Time at peak temperature : 10 seconds or less Preheating temperature (package surface temperature) : 120°C or below Maximum number of flow processes : 1 time Maximum chlorine content of rosin flux (% mass) : 0.2%(Wt.) or below	WS260
Partial Heating	Peak temperature (terminal temperature) : 350°C or below Soldering time (per side of device) : 3 seconds or less Maximum chlorine content of rosin flux (% mass) : 0.2%(Wt.) or below	HS350

Caution Do not use different soldering methods together (except for partial heating).

• **The information in this document is current as of February, 2008. The information is subject to change without notice. For actual design-in, refer to the latest publications of NEC Electronics data sheets or data books, etc., for the most up-to-date specifications of NEC Electronics products. Not all products and/or types are available in every country. Please check with an NEC Electronics sales representative for availability and additional information.**

• No part of this document may be copied or reproduced in any form or by any means without the prior written consent of NEC Electronics. NEC Electronics assumes no responsibility for any errors that may appear in this document.

• NEC Electronics does not assume any liability for infringement of patents, copyrights or other intellectual property rights of third parties by or arising from the use of NEC Electronics products listed in this document or any other liability arising from the use of such products. No license, express, implied or otherwise, is granted under any patents, copyrights or other intellectual property rights of NEC Electronics or others.

• Descriptions of circuits, software and other related information in this document are provided for illustrative purposes in semiconductor product operation and application examples. The incorporation of these circuits, software and information in the design of a customer's equipment shall be done under the full responsibility of the customer. NEC Electronics assumes no responsibility for any losses incurred by customers or third parties arising from the use of these circuits, software and information.

• While NEC Electronics endeavors to enhance the quality, reliability and safety of NEC Electronics products, customers agree and acknowledge that the possibility of defects thereof cannot be eliminated entirely. To minimize risks of damage to property or injury (including death) to persons arising from defects in NEC Electronics products, customers must incorporate sufficient safety measures in their design, such as redundancy, fire-containment and anti-failure features.

• NEC Electronics products are classified into the following three quality grades: "Standard", "Special" and "Specific".

The "Specific" quality grade applies only to NEC Electronics products developed based on a customer-designated "quality assurance program" for a specific application. The recommended applications of an NEC Electronics product depend on its quality grade, as indicated below. Customers must check the quality grade of each NEC Electronics product before using it in a particular application.

"Standard": Computers, office equipment, communications equipment, test and measurement equipment, audio and visual equipment, home electronic appliances, machine tools, personal electronic equipment and industrial robots.

"Special": Transportation equipment (automobiles, trains, ships, etc.), traffic control systems, anti-disaster systems, anti-crime systems, safety equipment and medical equipment (not specifically designed for life support).

"Specific": Aircraft, aerospace equipment, submersible repeaters, nuclear reactor control systems, life support systems and medical equipment for life support, etc.

The quality grade of NEC Electronics products is "Standard" unless otherwise expressly specified in NEC Electronics data sheets or data books, etc. If customers wish to use NEC Electronics products in applications not intended by NEC Electronics, they must contact an NEC Electronics sales representative in advance to determine NEC Electronics' willingness to support a given application.

(Note)

(1) "NEC Electronics" as used in this statement means NEC Electronics Corporation and also includes its majority-owned subsidiaries.

(2) "NEC Electronics products" means any product developed or manufactured by or for NEC Electronics (as defined above).

Subject: Compliance with EU Directives

CEL certifies, to its knowledge, that semiconductor and laser products detailed below are compliant with the requirements of European Union (EU) Directive 2002/95/EC Restriction on Use of Hazardous Substances in electrical and electronic equipment (RoHS) and the requirements of EU Directive 2003/11/EC Restriction on Penta and Octa BDE.

CEL Pb-free products have the same base part number with a suffix added. The suffix –A indicates that the device is Pb-free. The –AZ suffix is used to designate devices containing Pb which are exempted from the requirement of RoHS directive (*). In all cases the devices have Pb-free terminals. All devices with these suffixes meet the requirements of the RoHS directive.

This status is based on CEL’s understanding of the EU Directives and knowledge of the materials that go into its products as of the date of disclosure of this information.

Restricted Substance per RoHS	Concentration Limit per RoHS (values are not yet fixed)	Concentration contained in CEL devices	
		-A	-AZ
Lead (Pb)	< 1000 PPM	Not Detected	(*)
Mercury	< 1000 PPM	Not Detected	
Cadmium	< 100 PPM	Not Detected	
Hexavalent Chromium	< 1000 PPM	Not Detected	
PBB	< 1000 PPM	Not Detected	
PBDE	< 1000 PPM	Not Detected	

If you should have any additional questions regarding our devices and compliance to environmental standards, please do not hesitate to contact your local representative.

Important Information and Disclaimer: Information provided by CEL on its website or in other communications concerning the substance content of its products represents knowledge and belief as of the date that it is provided. CEL bases its knowledge and belief on information provided by third parties and makes no representation or warranty as to the accuracy of such information. Efforts are underway to better integrate information from third parties. CEL has taken and continues to take reasonable steps to provide representative and accurate information but may not have conducted destructive testing or chemical analysis on incoming materials and chemicals. CEL and CEL suppliers consider certain information to be proprietary, and thus CAS numbers and other limited information may not be available for release.

In no event shall CEL’s liability arising out of such information exceed the total purchase price of the CEL part(s) at issue sold by CEL to customer on an annual basis.

See CEL Terms and Conditions for additional clarification of warranties and liability.