

DATA SHEET

SKY65049-360LF: 1.7-2.4 GHz Low Noise Amplifier

Applications

- Wireless infrastructure: GSM, CDMA, WCDMA, and TD-SCDMA
- Ultra-low noise applications

Features

- Ultra-low Noise Figure = 0.7 dB @ 2.0 GHz
- Excellent input and output return loss
- Adjustable gain = 11.0 to 17.5 dB @ 2.0 GHz
- High output OIP3 = +34 dBm @ 65 mA
- OP1dB = +17.5 dBm @ 2.0 GHz
- Single, positive DC supply voltage
- Adjustable supply current, 30 to 100 mA
- Integrated on-die source inductors and interstage matching network
- Small, QFN (8-pin, 2 x 2 mm) package (MSL1, 260 °C per JEDEC J-STD-020)

NEW



Skyworks Green™ products are RoHS (Restriction of Hazardous Substances)-compliant, conform to the EIA/EICTA/JEITA Joint Industry Guide (JIG) Level A guidelines, are halogen free according to IEC-61249-2-21, and contain <1,000 ppm antimony trioxide in polymeric materials.

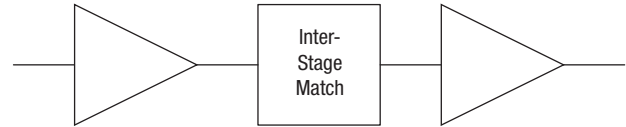

Figure 1. SKY65049-360LF Block Diagram

Description

The SKY65049-360LF is a high performance, two-stage ultra-Low Noise Amplifier (LNA). The device is fabricated from Skyworks advanced pHEMT process and is provided in a 2 x 2 mm, 8-pin Quad Flat No-Lead (QFN) package.

The device features excellent input and output return loss, and an integrated interstage matching network. The amplifier's ultra-low Noise Figure (NF), high gain, and excellent 3rd Order Intercept point (IP3) allow it to be used in various receiver and transmitter applications.

A functional block diagram is shown in Figure 1. The pin configuration and package are shown in Figure 2. Signal pin assignments and functional pin descriptions are provided in Table 1.

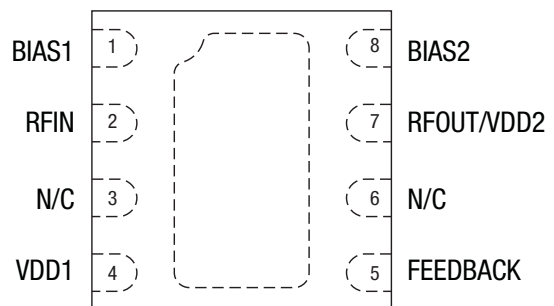

Figure 2. SKY65049-360LF Pinout – 8-Pin QFN (Top View)

Table 1. SKY65049-360LF Signal Descriptions

Pin #	Name	Description	Pin #	Name	Description
1	BIAS1	Source lead for 1 st stage transistor	5	FEEDBACK	Connect to RFOUT/VDD2 to reduce gain of 2 nd stage transistor
2	RFIN	RF input	6	N/C	No connection
3	N/C	No connection	7	RFOUT/VDD2	RF output. Requires a DC bias using an RF choke inductor.
4	VDD1	1 st stage DC power supply	8	BIAS2	Source lead for 2 nd stage transistor

Functional Description

The SKY65049-360LF is a two stage LNA with an integrated interstage matching network and source inductors. The device has a tested low NF of 0.7 dB and gain of 17 dB. The device allows designers to adjust current and gain without degrading the NF.

The external matching network largely dictates the RF performance of the device. The matching network is required for operation and special care should be taken when designing a circuit board layout for the SKY65049-360LF. There are four separate groups of external components: input, output, biasing, and feedback.

Biasing

To properly bias a depletion mode pHEMT, both the gate and drain of the device must be biased properly. At $V_{GS} = 0\text{ V}$ and $V_{DS} > 2\text{ V}$, the amplifier stage is in its saturated state and draws the maximum amount of current, I_{DSS} . A V_{DS} of 5 V is recommended to ensure proper performance.

To eliminate the need for a negative DC supply, self-biasing should be used when a resistor is placed between one of the source leads and ground. A bypass capacitor should be placed in parallel to this resistor to provide an RF ground and to ensure performance remains unchanged at the operating frequency.

When current flows from drain to source and through the resistor, the source voltage becomes biased above DC ground. The gate pin of the device should be left unbiased at 0 V, which creates the desired negative V_{GS} value. This simplifies the design by eliminating the need for a second DC supply. Values for resistor components R1 and R2 can be changed to easily increase or decrease the bias current to a desired level.

The first stage is biased at 20 percent of I_{DSS} to achieve the best NF performance. The gain and current of the 2nd stage amplifier can be adjusted without degrading the overall NF. More current in the 2nd stage yields better IP3 performance.

Biasing components R1, R2, C1, and C2 should be placed as close to the package pins as possible. See Figure 12 for the recommended board layout.

Source Inductance

The source inductance required on pins 1 and 8 (BIAS1 and BIAS2 signals, respectively) has been integrated on the die. This simplifies board layout and reduces build variations.

Input and Output RF Matching Network

The input band-pass matching network consists of four components. Component C1 serves as the input DC blocking capacitor, C2 provides high frequency stability and improved input return loss, and L1 and L2 are responsible for the best noise match looking into the gate of the first stage amplifier.

Excess board trace should be eliminated at the input of the device to minimize board losses. High-Q components should be used to achieve the best NF of the amplifier. Murata GJM series capacitors and Coilcraft HP or CS series inductors are recommended. Any excess board or component loss on the input of the device directly adds to the total measured NF.

The output matching network is band-pass network optimized for output return loss.

The SKY65049-360LF Evaluation Board assembly diagram is shown in Figure 12 and a circuit schematic is provided in Figure 13.

Feedback

Feedback is implemented in the recommended circuit on the 2nd stage transistor. Feedback improves the input and output return loss and high frequency stability. The gain of the device can be increased by increasing the value of R3, which reduces the amount of feedback present (gain for multiple feedback resistor values is shown in Figure 11).

Measuring NF

Special care should be taken when making < 1 dB NF measurements. Ideally, measurements should be made in an RF shield room. An Agilent MXA N9020A spectrum analyzer with an internal pre-amp paired with an N4001A smart noise source was used for all noise measurements. The smart noise source has an internal thermocouple that automatically sets the T_{COLD} setting on the analyzer. If a smart noise source is unavailable, a standard low Excess Noise Ratio (ENR) source should be used. Use an external thermocouple to manually adjust the T_{COLD} setting to ensure accurate results.

Electrical and Mechanical Specifications

The absolute maximum ratings of the SKY65049-360LF are provided in Table 2. The recommended operating conditions are specified in Table 3 and electrical specifications are provided in Table 4.

Performance characteristics for the SKY65049-360LF are illustrated in Figures 3 through 11.

Table 2. SKY65049-360LF Absolute Maximum Ratings

Parameter	Symbol	Minimum	Typical	Maximum	Units
Supply voltage	V _{DD}		5.5		V
Input power	P _{IN}		+13		dBm
Supply current stage one	I _{DS1}		50		mA
Supply current stage two	I _{DS2}		100		mA
Power dissipation	P _{DIS}		530		mW
Junction temperature	T _J		150		°C
Storage temperature	T _{STG}	-65		+125	°C
Operating temperature	T _{OP}	-40		+85	°C
Thermal resistance	Q _{JC}		47		°C/W

Note: Exposure to maximum rating conditions for extended periods may reduce device reliability. There is no damage to device with only one parameter set at the limit and all other parameters set at or below their nominal value. Exceeding any of the limits listed here may result in permanent damage to the device.

CAUTION: Although this device is designed to be as robust as possible, Electrostatic Discharge (ESD) can damage this device. This device must be protected at all times from ESD. Static charges may easily produce potentials of several kilovolts on the human body or equipment, which can discharge without detection. Industry-standard ESD precautions should be used at all times.

Table 3. SKY65049-360LF Recommended Operating Conditions

Parameter	Symbol	Minimum	Typical	Maximum	Units
Operating frequency	f	1.7		2.4	GHz
Supply voltage	V _{DD}	4.75	5.00	5.25	V
Supply current	I _{DD}	30	65	100	mA

Table 4. SKY65049-360LF Electrical Specifications (Note 1)

($T_{OP} = +25\text{ }^{\circ}\text{C}$, Characteristic Impedance [Z_0] = $50\ \Omega$, $V_{DD} = 5\ \text{V}$, $I_{DD} = 65\ \text{mA}$, $f = 2.0\ \text{GHz}$, Parameters Include Recommended 1.7 to 2.1 GHz Matching Network, Unless Otherwise Noted)

Parameter	Symbol	Test Condition	Min	Typical	Max	Units
Noise Figure (Note 2)	NF			0.7	0.9	dB
Gain	IS21I		15	17	18	dB
Input return loss	IS11I			-23		dB
Output return loss	IS22I			-10		dB
Reverse isolation	IS12I			-27		dB
3 rd Order Output Intercept Point	OIP3	10 MHz spacing, $P_{IN} = -18\ \text{dBm}$ per tone		+34		dBm
3 rd Order Input Intercept Point	IIP3	10 MHz spacing, $P_{IN} = -18\ \text{dBm}$ per tone		+17		dBm
1 dB Output Compression Point	OP1dB			+17.5		dBm
1 dB Input Compression Point	IP1dB			+1.5		dBm
Stability		Unconditionally stable up to 18 GHz		>1		K

Note 1: Performance is guaranteed only under the conditions listed in this Table and is not guaranteed over the full operating or storage temperature ranges. Operation at elevated temperatures may reduce reliability of the device.

Note 2: NF of device and matching network. Input RF connector and board loss de-embedded from measurement.

Typical Performance Characteristics

($T_{OP} = +25\text{ }^{\circ}\text{C}$, Characteristic Impedance [Z_0] = $50\ \Omega$, $V_{DD} = 5\ \text{V}$, $I_{DD} = 65\ \text{mA}$, Parameters Include a Recommended 1.7 to 2.1 GHz Matching Network, Unless Otherwise Noted)

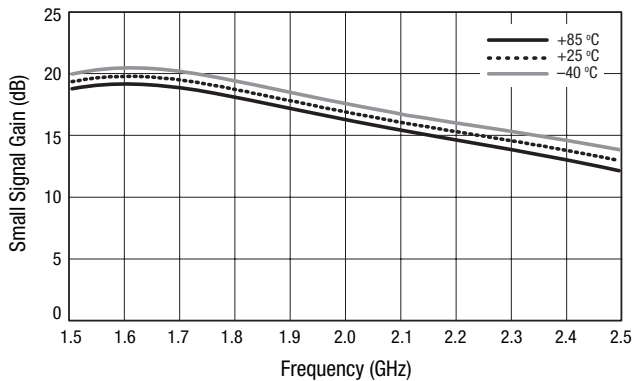

Figure 3. Small Signal Gain vs Frequency Over Temperature, ($P_{IN} = -20\ \text{dBm}$)

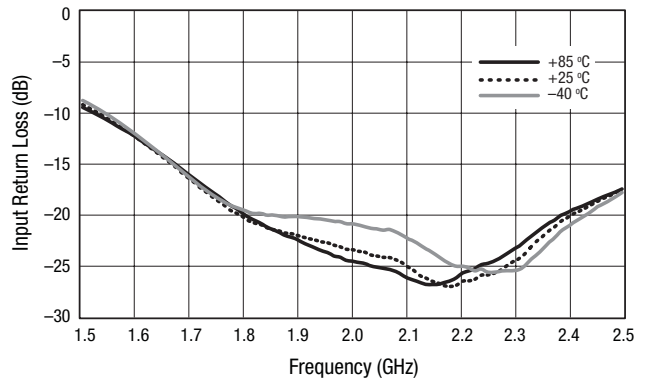

Figure 4. Input Return Loss vs Frequency Over Temperature, ($P_{IN} = -20\ \text{dBm}$)

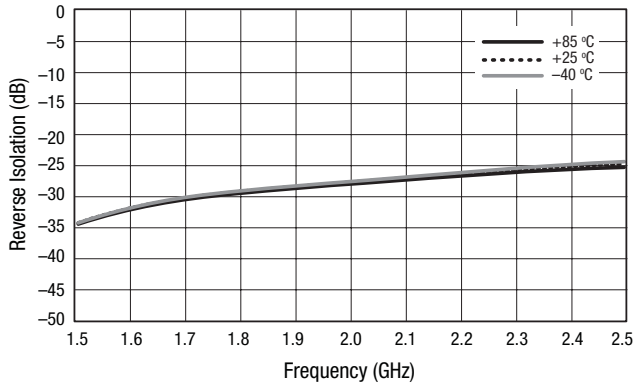

Figure 5. Reverse Isolation vs Frequency Over Temperature, ($P_{IN} = -20$ dBm)

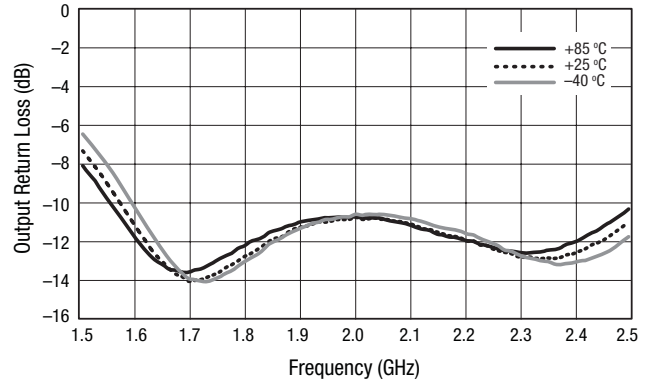

Figure 6. Output Return Loss vs Frequency Over Temperature, ($P_{IN} = -20$ dBm)

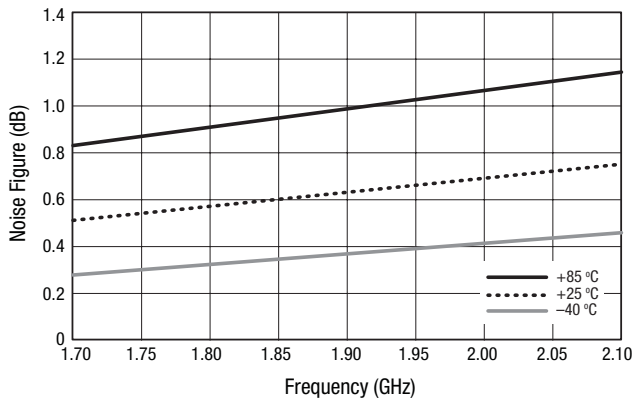

Figure 7. Noise Figure vs Frequency Over Temperature, Input RF Connector and Board Trace De-Embedded From Measurement

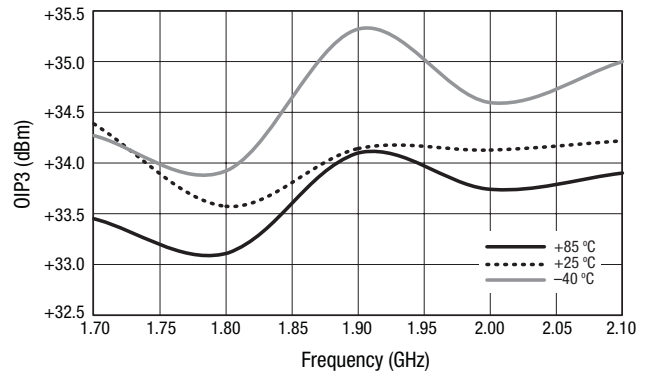

Figure 8. OIP3 vs Frequency Over Temperature, (Tone Spacing = 5 MHz, $P_{IN} = -18$ dBm/Tone)

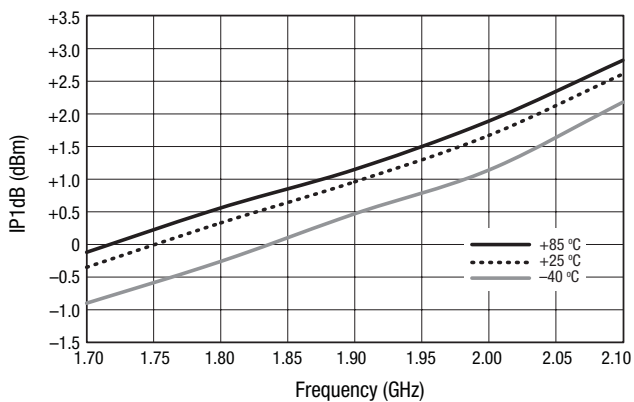

Figure 9. IP1dB vs Frequency Over Temperature

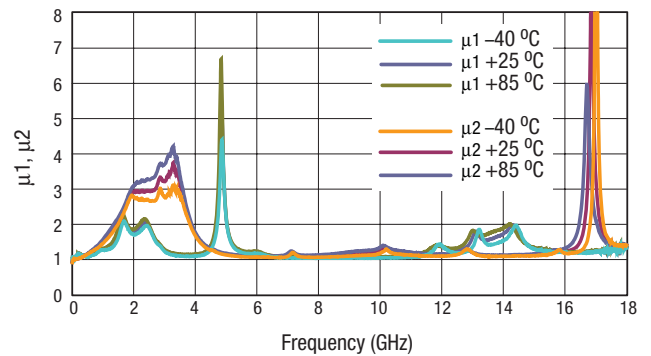

Figure 10. Stability vs Frequency Over Temperature ($P_{IN} = -20$ dBm)

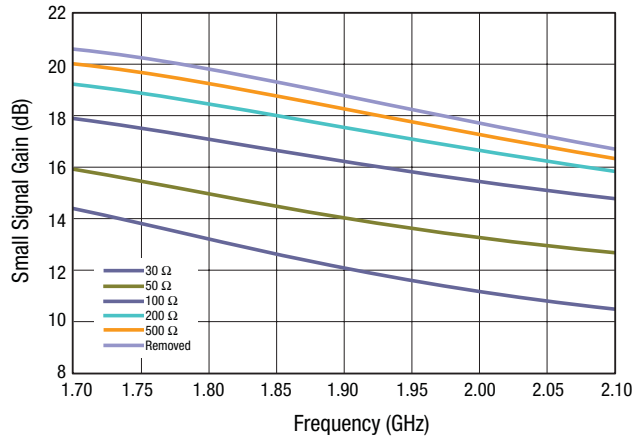

Figure 11. Small Signal Gain vs Frequency for Multiple Feedback Resistor Values

Evaluation Board Description

The SKY65049-360LF Evaluation Board is used to test the performance of the SKY65049-360LF low noise amplifier. An assembly drawing for the Evaluation Board is shown in Figure 12. The Evaluation Board schematic diagram is shown in Figure 13. Table 5 provides the Bill of Materials (BOM) list for Evaluation Board components.

Input and output trace lengths have been minimized to reduce losses. All surface mount components are 0402-sized to reduce component parasitics. The use of 0603 or larger components is not recommended. Component spacing has also been minimized. The board is provisioned with two RF connectors and a DC launch. The RF connector and board loss up to component C1 is approximately 0.1 dB at 2.0 GHz.

It is very important to place multiple ground vias as close to shunt components as possible. This ensures proper grounding and circuit performance.

Board material is 10 mil thick VT47 FR4 with 1 oz. copper cladding. RF input and output traces are 50 Ω.

Evaluation Board Test Procedure

- Step 1: Connect RF test equipment to amplifier input/output SMA connectors.
- Step 2: Connect DC ground.
- Step 3: Connect VDD to a +5 V supply with a current limit of 100 mA. Verify that the board draws approximately 65 mA.
- Step 4: Apply RF signal or noise source.

Package Dimensions

The PCB layout footprint for the SKY65049-360LF is shown in Figure 14. Typical case markings are shown in Figure 15. Package dimensions for the 8-pin QFN are shown in Figure 16, and tape and reel dimensions are provided in Figure 17.

Package and Handling Information

Instructions on the shipping container label regarding exposure to moisture after the container seal is broken must be followed. Otherwise, problems related to moisture absorption may occur when the part is subjected to high temperature during solder assembly.

THE SKY65049-360LF is rated to Moisture Sensitivity Level 1 (MSL1) at 260 °C. It can be used for lead or lead-free soldering.

Care must be taken when attaching this product, whether it is done manually or in a production solder reflow environment. Production quantities of this product are shipped in a standard tape and reel format. For packaging details, refer to the Skyworks Application Note, *Discrete Devices and IC Switch/Attenuators Tape and Reel Package Orientation*, document number 200083.

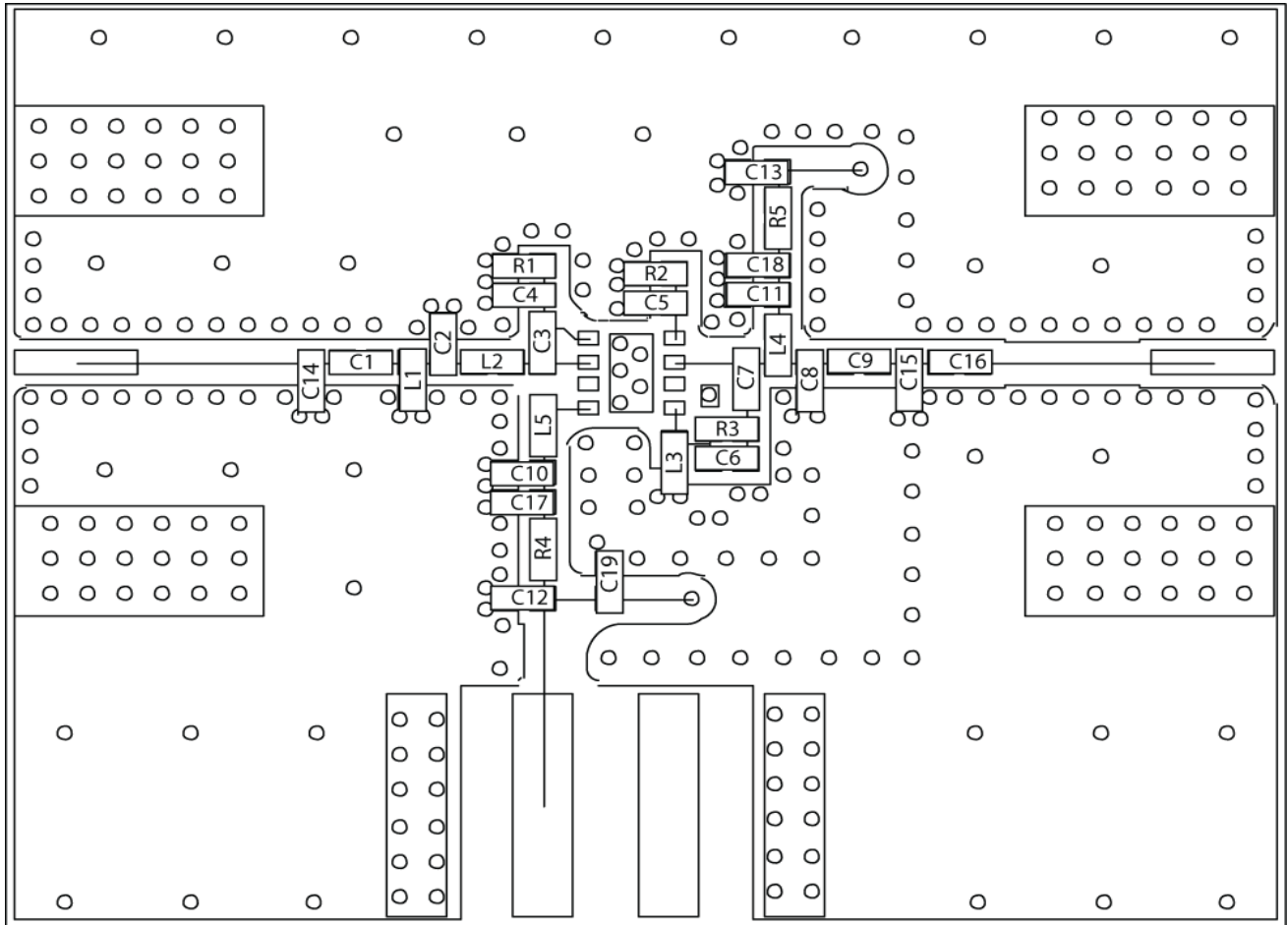

S1513

Figure 12. SKY65049-360LF Evaluation Board Assembly Diagram

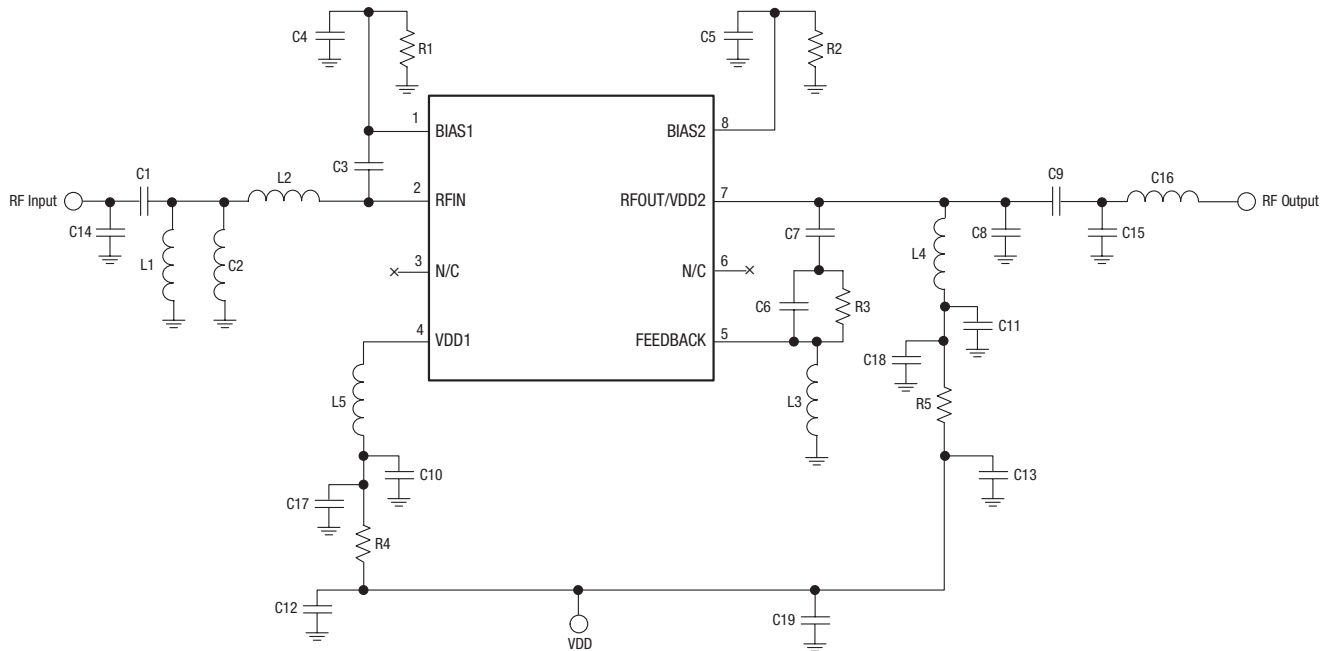

Note: Some component labels may be different than the corresponding component symbol shown here. Component values, however, as noted in Table 5, are accurate as of the date of this Data Sheet.

S1803

Figure 13. SKY65049-360LF Evaluation Board Schematic

Table 5. SKY65049-360LF (QFN Package) Evaluation Board Bill of Materials

Component	Value	Size	Manufacturer/Part Series	Component	Value	Size	Manufacturer/Part Series
C1	20 pF	0402	Murata GJM1555C	C17	2.2 pF	0402	Murata GRM1555C
C2	8.7 nH	0402	Coilcraft CS	C18	20 pF	0402	Murata GJM1555C
C3	0.2 pF	0402	Murata GJM1555C	C19	0.1 μF	0402	Murata GRM1555C
C4	4700 pF	0402	Murata GRM1555C	L1	DNP	–	–
C5	1000 pF	0402	Murata GRM1555C	L2	3.9 nH	0402	Murata
C6	0.5 pF	0402	Murata GJM1555C	L3	15 nH	0402	TDK MLG1005S
C7	2 pF	0402	Murata GJM1555C	L4	3.3 nH	0402	Taiyo Yuden HK
C8	0.75 pF	0402	Murata GJM1555C	L5	10 nH	0402	Taiyo Yuden HK
C9	8.2 pF	0402	Murata GRM1555C	R1	20 Ω	0402	Panasonic ERJ2RKF
C10	0.3 pF	0402	Murata GJM1555C	R2	9.1 Ω	0402	Panasonic ERJ2RKF
C11	10 pF	0402	Murata GRM1555C	R3	220 Ω	0402	Panasonic ERJ2RKF
C12	1000 pF	0402	Murata GRM1555C	R4	100 Ω	0402	Panasonic ERJ2RKF
C13, C14, C15	DNP	–	–	R5	20 Ω	0402	Panasonic ERJ2RKF
C16	1.5 nH	0402	TDK MLG1005S				

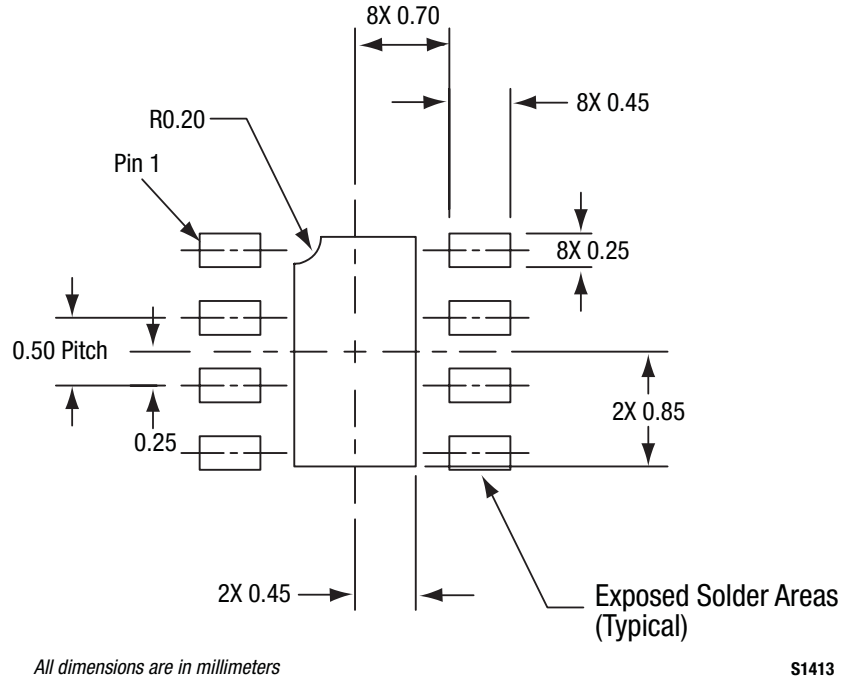

Figure 14. SKY65049-360LF PCB Layout Footprint

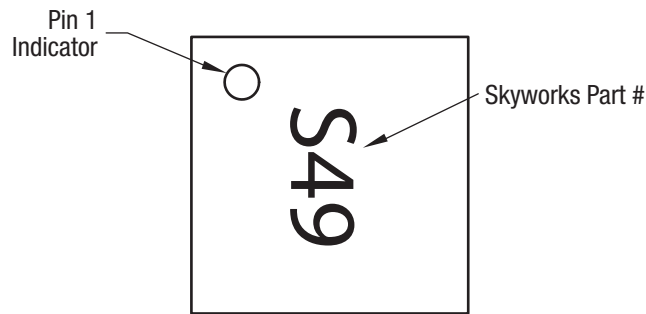
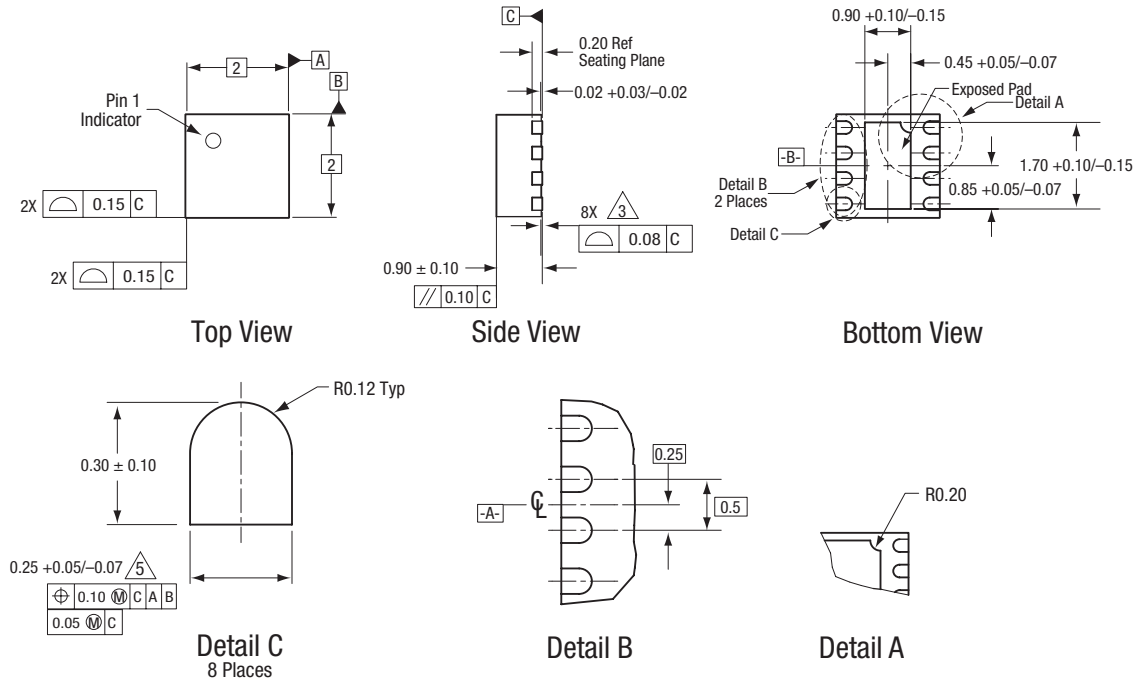

Figure 15. Typical Case Markings (Top View)



All measurements are in millimeters.
 Dimensioning and tolerancing according to ASME Y14.5M-1994.
 Coplanarity applies to the exposed heat sink slug as well as the terminals.
 Plating requirement per source control drawing (SCD) 2504.
 Dimension applies to metallized terminal and is measured between 0.15 mm and 0.30 mm from terminal tip.

S1415

Figure 16. SKY65049-360LF 8-Pin QFN Package Dimensions

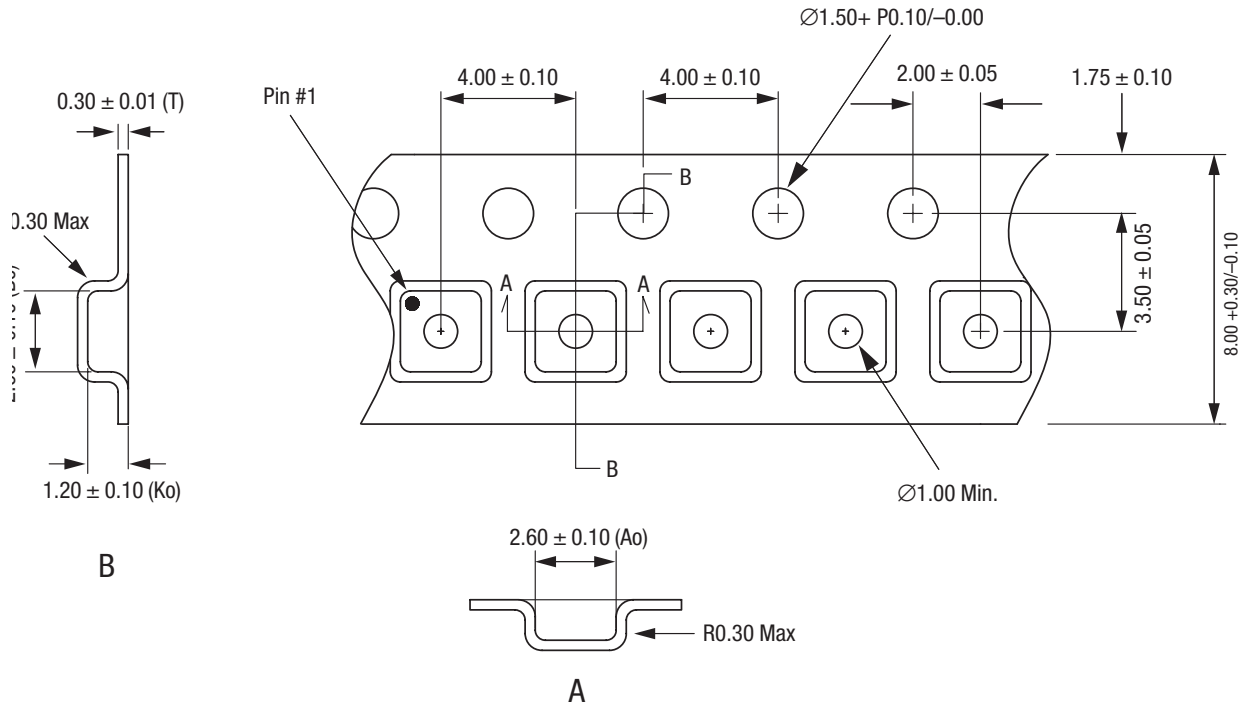

Notes:

1. Carrier tape: black conductive polystyrene.
2. Cover tape material: transparent conductive HSA.
3. Cover tape size: 5.40 mm width.
4. All measurements are in millimeters.

S1480

Figure 17. SKY65049-360LF Tape and Reel Dimensions

Ordering Information

Model Name	Manufacturing Part Number	Evaluation Kit Part Number
SKY65049-360LF Low Noise Amplifier	SKY65049-360LF (Pb-free and Green package)	SKY65049-360LF (1.7-2.1 GHz)

Copyright © 2009 Skyworks Solutions, Inc. All Rights Reserved.

Information in this document is provided in connection with Skyworks Solutions, Inc. ("Skyworks") products or services. These materials, including the information contained herein, are provided by Skyworks as a service to its customers and may be used for informational purposes only by the customer. Skyworks assumes no responsibility for errors or omissions in these materials or the information contained herein. Skyworks may change its documentation, products, services, specifications or product descriptions at any time, without notice. Skyworks makes no commitment to update the materials or information and shall have no responsibility whatsoever for conflicts, incompatibilities, or other difficulties arising from any future changes.

No license, whether express, implied, by estoppel or otherwise, is granted to any intellectual property rights by this document. Skyworks assumes no liability for any materials, products or information provided hereunder, including the sale, distribution, reproduction or use of Skyworks products, information or materials, except as may be provided in Skyworks Terms and Conditions of Sale.

THE MATERIALS, PRODUCTS AND INFORMATION ARE PROVIDED "AS IS" WITHOUT WARRANTY OF ANY KIND, WHETHER EXPRESS, IMPLIED, STATUTORY, OR OTHERWISE, INCLUDING FITNESS FOR A PARTICULAR PURPOSE OR USE, MERCHANTABILITY, PERFORMANCE, QUALITY OR NON-INFRINGEMENT OF ANY INTELLECTUAL PROPERTY RIGHT; ALL SUCH WARRANTIES ARE HEREBY EXPRESSLY DISCLAIMED. SKYWORKS DOES NOT WARRANT THE ACCURACY OR COMPLETENESS OF THE INFORMATION, TEXT, GRAPHICS OR OTHER ITEMS CONTAINED WITHIN THESE MATERIALS. SKYWORKS SHALL NOT BE LIABLE FOR ANY DAMAGES, INCLUDING BUT NOT LIMITED TO ANY SPECIAL, INDIRECT, INCIDENTAL, STATUTORY, OR CONSEQUENTIAL DAMAGES, INCLUDING WITHOUT LIMITATION, LOST REVENUES OR LOST PROFITS THAT MAY RESULT FROM THE USE OF THE MATERIALS OR INFORMATION, WHETHER OR NOT THE RECIPIENT OF MATERIALS HAS BEEN ADVISED OF THE POSSIBILITY OF SUCH DAMAGE.

Skyworks products are not intended for use in medical, lifesaving or life-sustaining applications, or other equipment in which the failure of the Skyworks products could lead to personal injury, death, physical or environmental damage. Skyworks customers using or selling Skyworks products for use in such applications do so at their own risk and agree to fully indemnify Skyworks for any damages resulting from such improper use or sale.

Customers are responsible for their products and applications using Skyworks products, which may deviate from published specifications as a result of design defects, errors, or operation of products outside of published parameters or design specifications. Customers should include design and operating safeguards to minimize these and other risks. Skyworks assumes no liability for applications assistance, customer product design, or damage to any equipment resulting from the use of Skyworks products outside of stated published specifications or parameters.

Skyworks, the Skyworks symbol, and "Breakthrough Simplicity" are trademarks or registered trademarks of Skyworks Solutions, Inc., in the United States and other countries. Third-party brands and names are for identification purposes only, and are the property of their respective owners. Additional information, including relevant terms and conditions, posted at www.skyworksinc.com, are incorporated by reference.