

MGA-62563

Current-Adjustable, Low Noise Amplifier



Data Sheet

Description

Avago's MGA-62563 is an economical, easy-to-use GaAs MMIC amplifier that offers excellent linearity and low noise figure for applications from 0.1 to 3.5 GHz. Packaged in an miniature SOT-363 package, it requires half the board space of a SOT-143 package.

One external resistor is used to set the bias current taken by the device over a wide range. This allows the designer to use the same part in several circuit positions and tailor the linearity performance (and current consumption) to suit each position.

The output of the amplifier is matched to 50Ω (below 2:1 VSWR) across the entire bandwidth and only requires minimum input matching. The amplifier allows a wide dynamic range by offering a 0.9 dB NF coupled with a +32.9 dBm Output IP3. The circuit uses state-of-the-art E-pHEMT technology with proven reliability. On-chip bias circuitry allows operation from a single +3V power supply, while internal feedback ensures stability ($K > 1$) over all frequencies.

Pin Connections and Package Marking

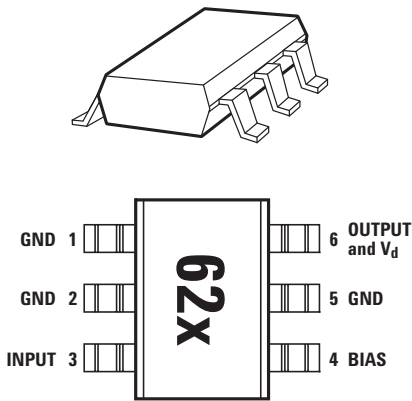

Note:
 Package marking provides orientation and identification:
 "62" = Device Code
 "x" = Date code indicates the month of manufacture.

Features

- Single +3V supply
- High linearity
- Low noise figure
- Miniature package
- Unconditionally stable

Specifications

at 500 MHz; 3V, 60 mA (Typ.)

- 0.9 dB noise figure
- 32.9 dBm OIP3
- 22 dB gain
- 17.8 dBm P_{1dB}

Simplified Schematic

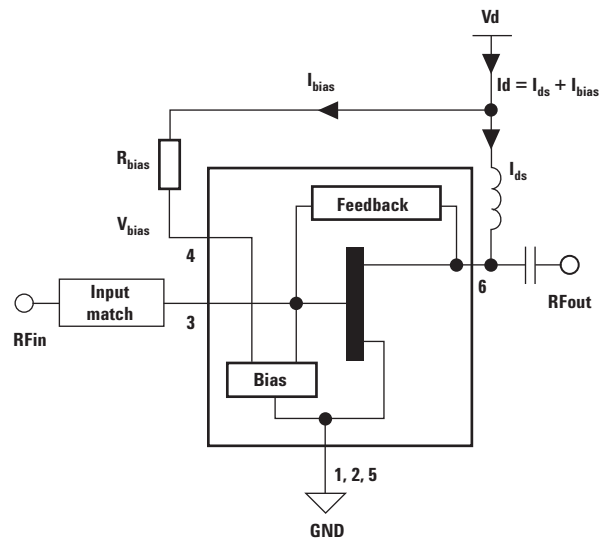

MGA-62563 Absolute Maximum Ratings^[1]

Symbol	Parameter	Units	Absolute Maximum
V_d	Device Voltage (pin 6) ^[2]	V	6
I_d	Device Current (pin 6) ^[2]	mA	100
P_{in}	CW RF Input Power (pin 3) ^[3]	dBm	21
I_{ref}	Bias Reference Current (pin 4)	mA	12
P_{diss}	Total Power Dissipation ^[4]	mW	600
T_{CH}	Channel Temperature	°C	150
T_{STG}	Storage Temperature	°C	150
θ_{ch_b}	Thermal Resistance ^[5]	°C/W	97

Notes:

1. Operation of this device above any one of these parameters may cause permanent damage.
2. Bias is assumed at DC quiescent conditions.
3. With the DC (typical bias) and RF applied to the device at board temperature $T_B = 25^\circ\text{C}$.
4. Total dissipation power is referred to board (package belly) temperature $T_B = 85^\circ\text{C}$, P_{diss} is required to derate at $10\text{ mW}/^\circ\text{C}$ for $T_B > 85^\circ\text{C}$.
5. Thermal resistance measured using 150°C Liquid Crystal Measurement method.

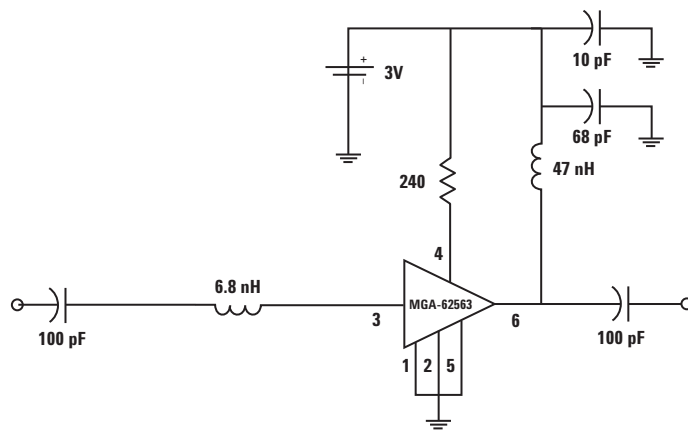

Figure 1. Test circuit of the 0.5 GHz production test board used for NF, Gain and OIP3 measurements. This circuit achieves a trade-off between optimal NF, Gain, OIP3 and input return loss. Circuit losses have been de-embedded from actual measurements.

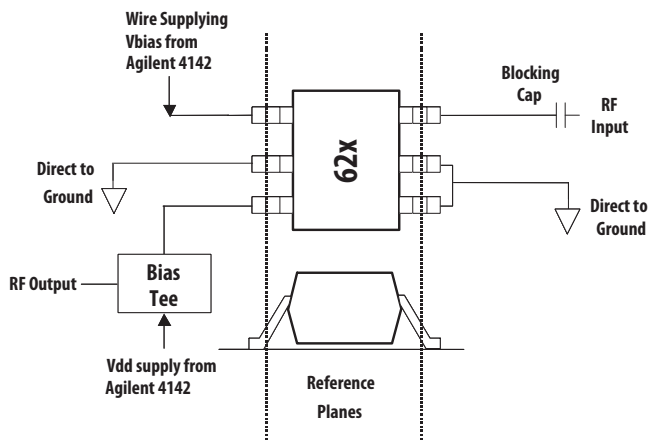

Figure 1b. A diagram showing the connection to the DUT during an S and Noise parameter measurement using an automated tuner system.

Product Consistency Distribution Charts at 3V, 0.5 GHz, $R_{bias} = 240\Omega$ ^[1]

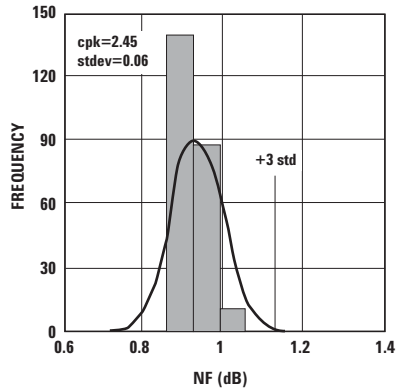

Figure 2. NF @ 2 GHz 3V 60 mA.
USL=1.4, Nominal=0.93.

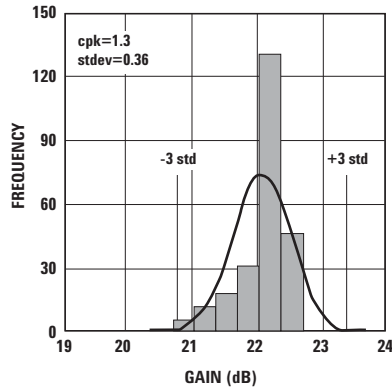

Figure 3. Gain @ 2 GHz 3V 60 mA.
LSL =20.4, Nominal = 22, USL = 23.4

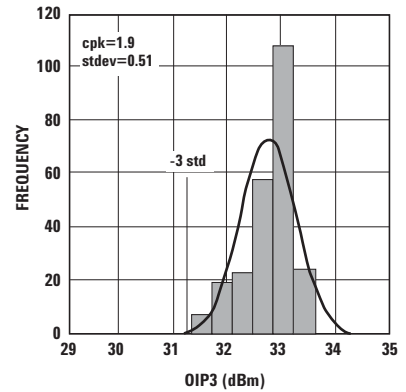

Figure 4. OIP3 @ 2 GHz 3V 60 mA.
LSL=30, Nominal=32.9.

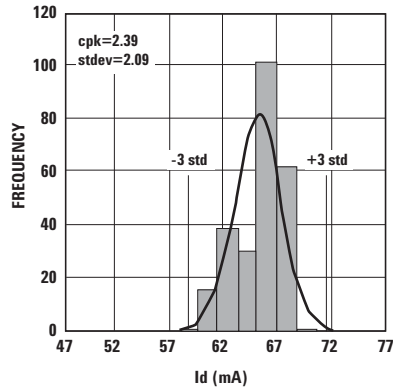

Figure 5. Id @ 3V.
LSL = 47, Nominal = 62, USL = 77

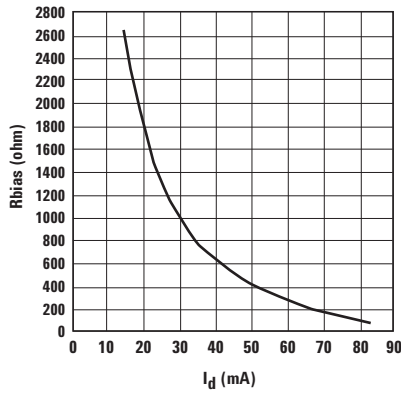

Figure 6. Rbias vs. Id (3V supply).

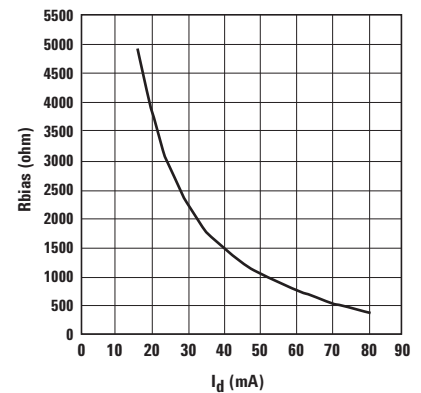

Figure 7. Rbias vs. Id (5V supply).

Note:

1. Measured on the production test circuit

MGA-62563 Electrical Specifications

$T_C = 25^\circ\text{C}$, $Z_O = 50\Omega$, $V_d = 3\text{V}$ (unless otherwise specified)

Symbol	Parameters and Test Conditions	Freq	Units	Min.	Typ.	Max.	Std Dev
$I_d^{[1,2]}$	Device Current		mA	47	62	77	2.09
$NF_{\text{test}}^{[1,2]}$	Noise Figure in test circuit ^[1]	f = 0.5 GHz	dB		0.93	1.4	0.06
$G_{\text{test}}^{[1,2]}$	Associated Gain in test circuit ^[1]	f = 0.5 GHz	dB	20.4	22	23.4	0.36
$OIP3_{\text{test}}^{[1,2]}$	Output 3 rd Order Intercept in test circuit ^[1]	f = 0.5 GHz	dBm	30	32.9		0.51
$NF_{50\Omega}^{[3]}$	Noise Figure in 50 Ω system	f = 0.1 GHz f = 0.2 GHz f = 0.5 GHz f = 1.0 GHz f = 1.5 GHz f = 2.0 GHz f = 2.5 GHz f = 3.0 GHz	dB		1.1 1.0 0.8 0.9 1.0 1.2 1.3 1.5		0.06
$ S_{21} ^2_{50\Omega}^{[3]}$	Associated Gain in 50 Ω system	f = 0.1 GHz f = 0.2 GHz f = 0.5 GHz f = 1.0 GHz f = 1.5 GHz f = 2.0 GHz f = 2.5 GHz f = 3.0 GHz	dB		23.5 23 22 20 17 15.5 14 13		0.36
$OIP3_{50\Omega}^{[3]}$	Output 3 rd Order Intercept Point in 50 Ω system	f = 0.1 GHz f = 0.2 GHz f = 0.5 GHz f = 1.0 GHz f = 1.5 GHz f = 2.0 GHz f = 2.5 GHz f = 3.0 GHz	dBm		34.7 34.7 34.8 33.5 33 32.3 32 31		0.51
$P1dB_{50\Omega}^{[3]}$	Output Power at 1dB Gain Compression in 50 Ω system	f = 0.1 GHz f = 0.2 GHz f = 0.5 GHz f = 1.0 GHz f = 1.5 GHz f = 2.0 GHz f = 2.5 GHz f = 3.0 GHz	dBm		18 18 17.6 17.6 17.7 17.9 17.7		18

Notes:

1. Guaranteed specifications are 100% tested in the production test circuit as shown in Figure 1, the typical value is based on measurement of at least 500 parts from three non-consecutive wafer lots during initial characterization of this product.
2. Circuit achieved a trade-off between optimal NF, Gain, OIP3 and input return loss.
3. Parameter quoted at 50 Ω is based on measurement of selected typical parts tested on a 50 Ω input and output test fixture.

MGA-62563 Typical Performance, $V_d = 3V, I_{ds} = 60\text{ mA}$ at 50Ω Input and Output

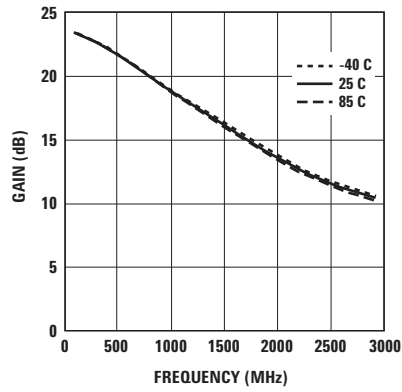

Figure 8. Gain vs. Frequency (3V 60 mA).

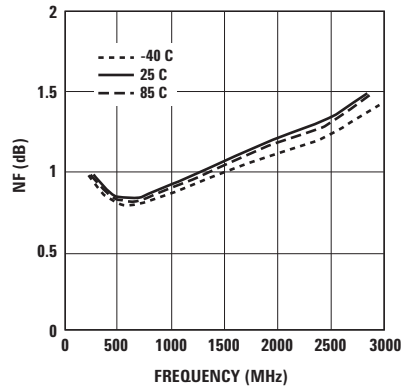

Figure 9. NF vs. Frequency (3V 60 mA).

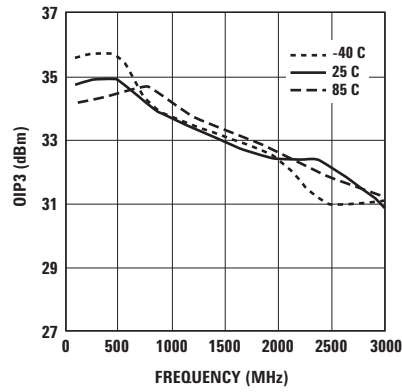

Figure 10. OIP3 vs. Frequency (3V 60 mA).

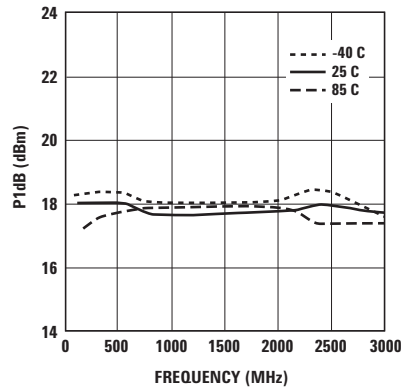

Figure 11. P1dB vs. Frequency (3V 60 mA).

MGA-62563 Typical Performance, $V_d = 3V$, $I_{ds} = 30\text{ mA}$ at 50Ω Input and Output

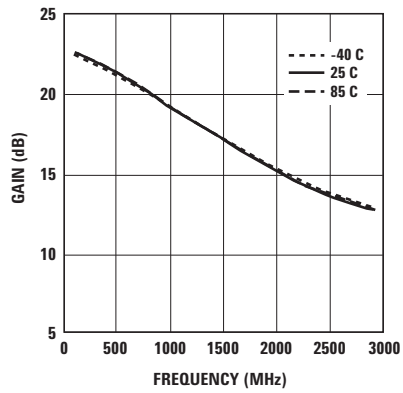

Figure 12. Gain vs. Frequency (3V 30 mA).

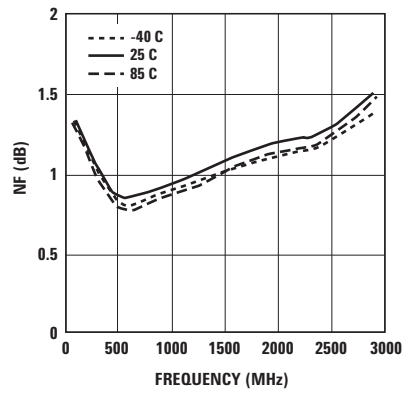

Figure 13. NF vs. Frequency (3V 30 mA).

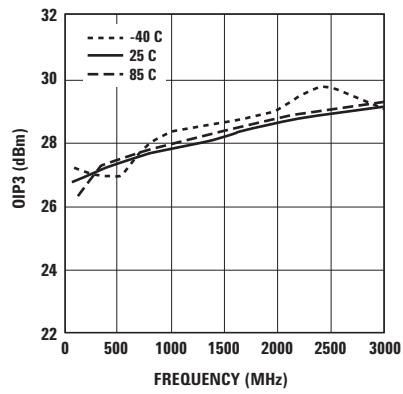

Figure 14. OIP3 vs. Frequency (3V 30 mA).

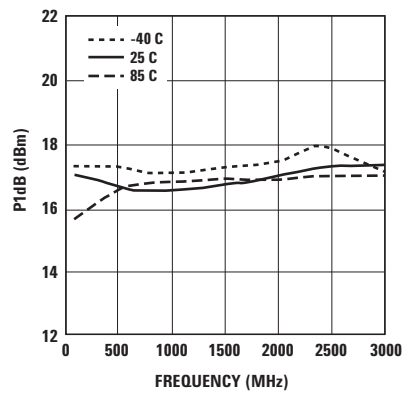

Figure 15. P1dB vs. Frequency (3V 30 mA).

MGA-62563 Typical Performance, $V_d = 5V$, $I_{ds} = 60\text{ mA}$ at 50Ω Input and Output

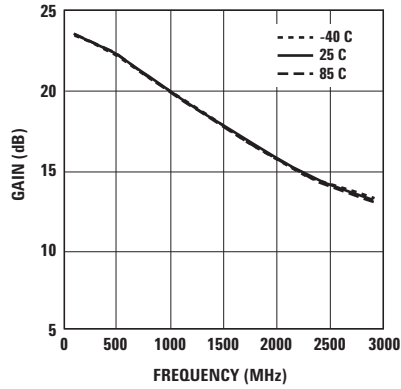

Figure 16. Gain vs. Frequency (5V 60 mA).

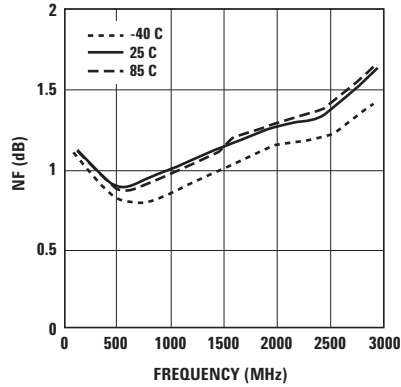

Figure 17. NF vs. Frequency (5V 60 mA).

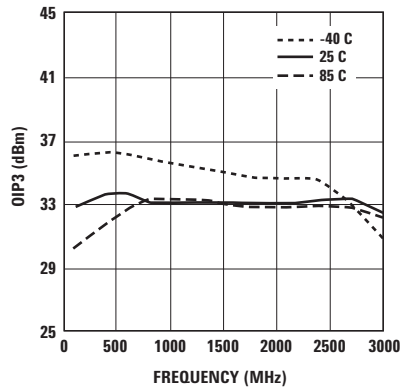

Figure 18. OIP3 vs. Frequency (5V 60 mA).

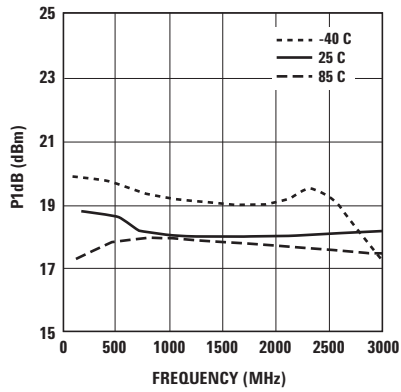

Figure 19. P1dB vs. Frequency (5V 60 mA).

MGA-62563 Typical Performance, $V_d = 5V$, $I_{ds} = 30\text{ mA}$ at 50Ω Input and Output

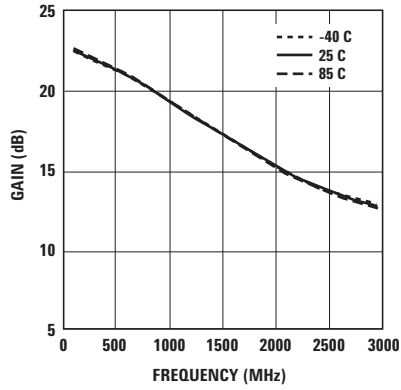

Figure 20. Gain vs. Frequency (5V 30 mA).

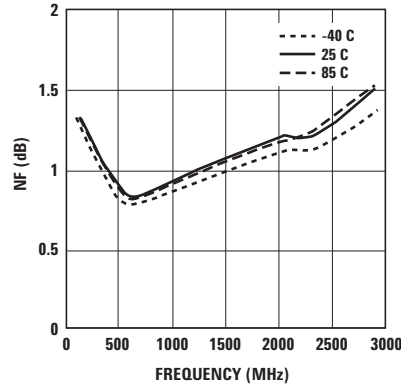

Figure 21. NF vs. Frequency (5V 30 mA).

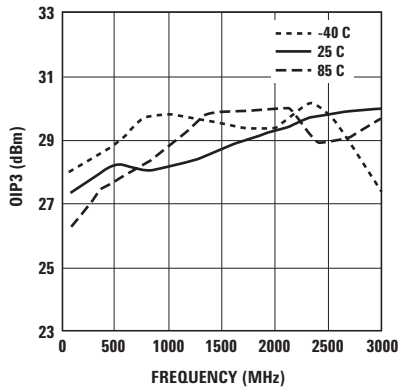

Figure 22. OIP3 vs. Frequency (5V 30 mA).

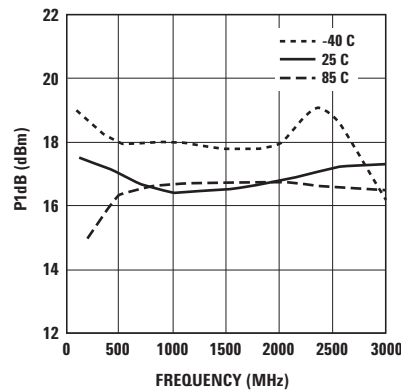

Figure 23. P1dB vs. Frequency (5V 30 mA).

MGA-62563 Typical Performance, Freq=0.5 GHz, $T_C=25^\circ\text{C}$ at 50Ω Input and Output

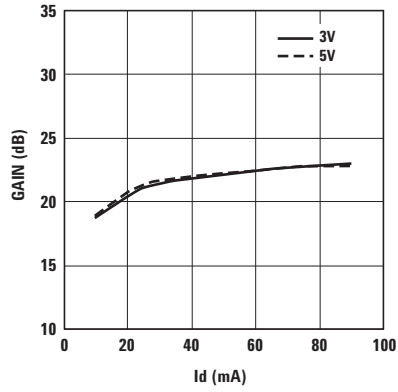

Figure 24. Gain vs. Id (500 MHz).

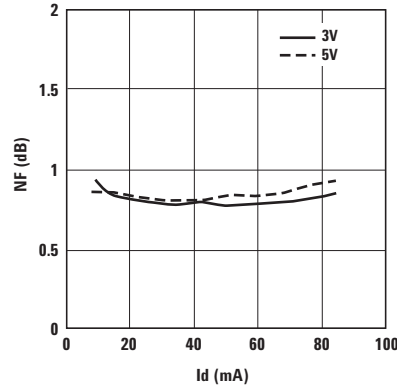

Figure 25. NF vs. Id (500 MHz).

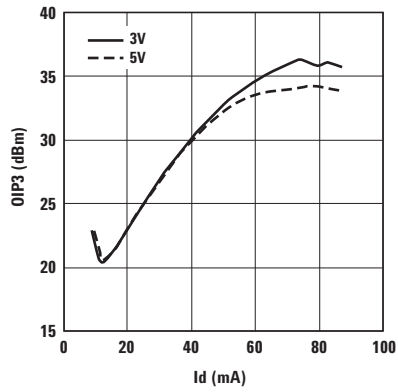

Figure 26. OIP3 vs. Id (500 MHz).

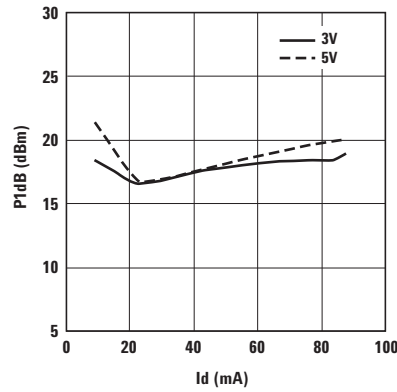

Figure 27. P1dB vs. Id (500 MHz).

MGA-62563 Typical Performance, Freq=0.1 GHz, T_C=25°C at 50Ω Input and Output

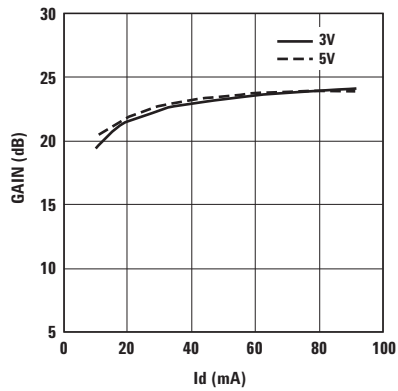

Figure 28. Gain vs. Id (100 MHz).

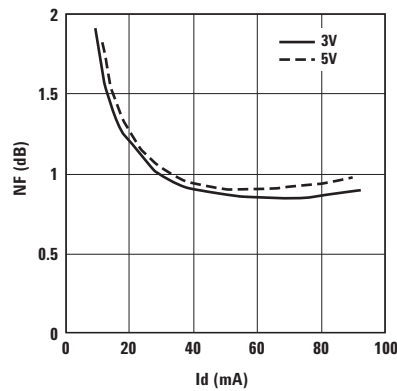

Figure 29. NF vs. Id (100 MHz).

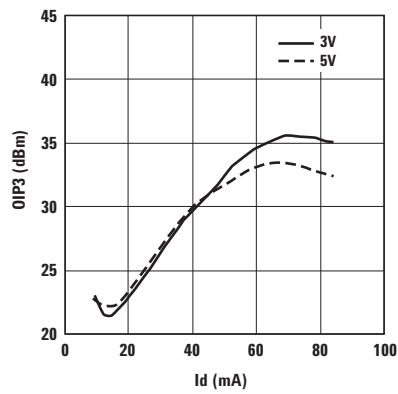

Figure 30. OIP3 vs. Id (100 MHz).

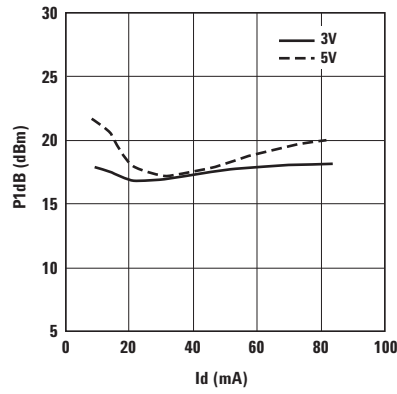

Figure 31. P1dB vs. Id (100 MHz).

MGA-62563 Typical Scattering Parameters, $T_C = 25^\circ\text{C}$, $Z_0 = 50\Omega$, $V_d = 3\text{V}$, $I_{ds} = 60\text{mA}$

Freq. GHz	S_{11}		S_{21}			S_{12}		S_{22}		K-factor
	Mag.	Ang.	dB	Mag.	Ang.	Mag.	Ang.	Mag.	Ang.	
0.1	0.185	-82.272	22.91	13.982	155.827	0.042	5.4	0.129	-164.437	1.09
0.2	0.187	-90.11	22.63	13.537	153.346	0.042	5.474	0.135	-168.363	1.1
0.3	0.193	-98.147	22.31	13.054	150.578	0.042	5.636	0.141	-172.09	1.12
0.4	0.203	-106.14	21.97	12.545	147.524	0.042	5.912	0.148	-175.737	1.15
0.5	0.217	-114.27	21.57	11.986	143.942	0.042	6.346	0.154	-179.503	1.17
0.6	0.233	-121.367	21.18	11.459	140.212	0.041	6.892	0.159	177.105	1.22
0.7	0.252	-127.882	20.78	10.945	136.065	0.041	7.583	0.163	173.986	1.25
0.8	0.272	-133.795	20.39	10.457	131.465	0.041	8.43	0.167	171.256	1.27
0.9	0.295	-138.842	20.02	10.021	126.434	0.041	9.417	0.171	168.886	1.3
1	0.317	-143.232	19.66	9.611	121.342	0.042	10.645	0.173	167.409	1.3
1.1	0.34	-147.643	19.26	9.179	116.107	0.042	12.083	0.175	166.393	1.32
1.2	0.358	-151.668	18.87	8.78	111.387	0.042	13.52	0.177	165.719	1.35
1.3	0.371	-154.625	18.48	8.397	106.965	0.043	14.99	0.172	164.894	1.36
1.4	0.378	-156.903	18.1	8.035	102.832	0.044	16.437	0.163	164.215	1.38
1.5	0.385	-159.101	17.71	7.684	98.886	0.045	17.798	0.153	164.02	1.4
1.6	0.392	-161.727	17.32	7.349	95.185	0.046	19.056	0.144	163.07	1.42
1.7	0.397	-164.752	16.92	7.015	91.424	0.048	20.227	0.132	162.822	1.42
1.8	0.4	-167.685	16.55	6.72	88.093	0.049	21.207	0.122	162.927	1.44
1.9	0.4	-170.686	16.19	6.446	84.931	0.051	22.085	0.113	163.177	1.44
2	0.4	-173.615	15.84	6.195	81.892	0.052	22.821	0.104	163.203	1.47
2.5	0.401	171.986	14.29	5.184	67.423	0.063	24.202	0.059	160.575	1.46
3	0.391	153.64	12.93	4.432	53.871	0.074	22.323	0.029	162.52	1.46
3.5	0.418	141.02	11.87	3.923	39.725	0.088	16.919	0.024	14.44	1.37
4	0.461	127.008	10.81	3.472	26.244	0.099	11.289	0.043	17.922	1.32
4.5	0.548	119.58	9.83	3.1	11.923	0.108	4.074	0.083	3.197	1.22
5	0.615	105.771	8.73	2.733	-1.958	0.119	-3.141	0.057	18.181	1.14
5.5	0.674	97.228	7.69	2.425	-13.281	0.126	-10.835	0.026	-8.344	1.05
6	0.701	85.967	7.26	2.308	-24.509	0.131	-17.126	0.096	123.432	1.01
6.5	0.698	77.659	6.44	2.099	-35.324	0.138	-24.617	0.165	105.103	1.06
7	0.69	66.448	6.33	2.072	-47.318	0.145	-31.049	0.259	92.547	1.06
7.5	0.677	55.492	5.55	1.895	-59.77	0.15	-39.087	0.284	78.001	1.14
8	0.673	45.318	5.18	1.816	-68.839	0.157	-45.822	0.294	70.774	1.14
9	0.718	26.713	4.61	1.701	-88.8	0.167	-62.304	0.323	48.33	1.07
10	0.778	15.285	4.14	1.61	-104.215	0.168	-76.006	0.364	24.415	0.99

Typical Noise Parameters at 25°C ,

$T_C = 25^\circ\text{C}$, $Z_0 = 50\Omega$, $V_d = 3\text{V}$, $I_{ds} = 60\text{mA}$

Freq GHz	F_{min} dB	Γ_{opt} Mag.	Γ_{opt} Ang.	$R_n/50$	NF@50Ω dB
0.5	0.79	0.08	57.8	0.12	0.8
1	0.65	0.07	168.2	0.07	0.65
1.5	0.76	0.12	-176.7	0.07	0.77
2	0.87	0.13	149.3	0.08	0.89
2.5	0.93	0.16	-179	0.08	0.97
3	0.96	0.23	-164.8	0.08	1.06
3.5	1.11	0.24	-150	0.09	1.22
4	1.28	0.27	-142.7	0.11	1.43
4.5	1.36	0.33	-133.7	0.12	1.61
5	1.44	0.38	-123	0.15	1.79
5.5	1.47	0.43	-114	0.19	1.97
6	1.63	0.45	-103.6	0.25	2.2
6.5	1.69	0.5	-94.5	0.34	2.47
7	1.77	0.54	-85.3	0.43	2.71
7.5	1.94	0.58	-75.1	0.57	3.08
8	2.07	0.6	-64.9	0.77	3.42
8.5	2.25	0.64	-54.6	1	3.89
9	2.4	0.67	-45.9	1.28	4.31
9.5	2.25	0.75	-39.2	1.6	4.77
10	2.44	0.74	-34	1.91	5.14

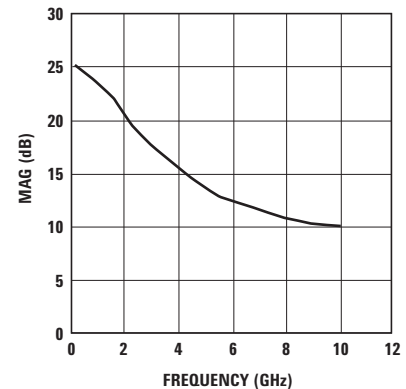

Figure 32. MAG vs. Frequency.

MGA-62563 Typical Scattering Parameters, $T_C = 25^\circ\text{C}$, $Z_0 = 50\Omega$, $V_d = 3\text{V}$, $I_{ds} = 30\text{mA}$

Freq. GHz	S_{11}		S_{21}			S_{12}		S_{22}		K-factor
	Mag.	Ang.	dB	Mag.	Ang.	Mag.	Ang.	Mag.	Ang.	
0.1	0.229	-64.839	21.81	12.314	156.524	0.049	5.851	0.088	-127.44	1.06
0.2	0.225	-72.068	21.54	11.942	153.986	0.049	5.688	0.093	-135.628	1.08
0.3	0.224	-80.018	21.24	11.537	151.158	0.049	5.569	0.1	-143.242	1.09
0.4	0.227	-88.494	20.91	11.11	148.033	0.049	5.526	0.108	-150.147	1.11
0.5	0.234	-97.66	20.54	10.643	144.386	0.048	5.588	0.116	-156.622	1.15
0.6	0.246	-106.065	20.17	10.202	140.583	0.048	5.738	0.125	-161.903	1.17
0.7	0.261	-113.999	19.8	9.774	136.408	0.048	6.002	0.133	-166.307	1.19
0.8	0.28	-121.285	19.43	9.369	131.811	0.048	6.379	0.141	-169.879	1.22
0.9	0.302	-127.551	19.1	9.012	126.834	0.048	6.887	0.15	-172.861	1.23
1	0.324	-133.004	18.77	8.676	121.818	0.049	7.629	0.158	-174.888	1.23
1.1	0.348	-138.366	18.4	8.322	116.64	0.049	8.559	0.166	-176.589	1.24
1.2	0.367	-143.111	18.05	7.993	111.957	0.049	9.506	0.174	-178.07	1.26
1.3	0.38	-146.63	17.69	7.669	107.573	0.05	10.548	0.174	-179.151	1.27
1.4	0.39	-149.336	17.33	7.356	103.466	0.051	11.645	0.168	-179.685	1.28
1.5	0.399	-151.941	16.97	7.052	99.534	0.052	12.668	0.162	-179.868	1.29
1.6	0.407	-154.928	16.6	6.758	95.851	0.053	13.646	0.156	179.214	1.31
1.7	0.413	-158.278	16.21	6.466	92.108	0.054	14.581	0.148	179.163	1.33
1.8	0.416	-161.47	15.86	6.207	88.778	0.055	15.393	0.141	179.311	1.35
1.9	0.418	-164.666	15.51	5.965	85.613	0.057	16.142	0.134	179.509	1.36
2	0.417	-167.751	15.18	5.744	82.561	0.058	16.791	0.128	179.436	1.38
2.5	0.422	177.274	13.71	4.848	67.999	0.068	18.161	0.089	176.954	1.4
3	0.412	158.337	12.41	4.174	54.232	0.079	16.464	0.062	176.77	1.42
3.5	0.442	144.969	11.39	3.71	39.961	0.092	11.54	0.015	130.879	1.35
4	0.486	129.994	10.34	3.287	26.316	0.102	6.16	0.028	68.898	1.32
4.5	0.573	121.597	9.35	2.935	11.973	0.111	-0.792	0.063	24.183	1.21
5	0.638	107.123	8.25	2.585	-2.051	0.122	-7.727	0.057	50.418	1.13
5.5	0.696	98.232	7.18	2.285	-13.425	0.128	-15.159	0.026	55.253	1.05
6	0.721	86.681	6.73	2.169	-24.666	0.131	-21.346	0.124	119.497	1
6.5	0.713	78.214	5.85	1.961	-35.535	0.139	-28.725	0.191	103.907	1.06
7	0.704	66.96	5.7	1.927	-47.61	0.146	-34.963	0.287	91.799	1.06
7.5	0.687	55.912	4.88	1.753	-60.15	0.15	-42.644	0.31	77.221	1.16
8	0.68	45.807	4.47	1.673	-69.283	0.156	-49.076	0.318	69.627	1.18
9	0.725	27.162	3.85	1.558	-89.513	0.166	-65.125	0.343	47.128	1.1
10	0.787	15.674	3.34	1.469	-105.215	0.168	-78.788	0.382	23.467	1

Typical Noise Parameters at 25°C,

$T_C = 25^\circ\text{C}$, $Z_0 = 50\Omega$, $V_d = 3\text{V}$, $I_{ds} = 30\text{mA}$

Freq GHz	F_{min} dB	Γ_{opt} Mag.	Γ_{opt} Ang.	$R_n/50$	NF@50Ω dB
0.5	0.76	0.07	92.8	0.1	0.77
1	0.66	0.06	149.8	0.08	0.67
1.5	0.79	0.09	167.2	0.07	0.8
2	0.86	0.14	142.8	0.08	0.88
2.5	0.91	0.15	167.5	0.08	0.95
3	0.94	0.23	-174.7	0.07	1.03
3.5	1.07	0.24	-159.3	0.08	1.17
4	1.21	0.27	-148.9	0.09	1.35
4.5	1.28	0.32	-140.7	0.11	1.51
5	1.39	0.36	-129.5	0.13	1.69
5.5	1.43	0.4	-119.9	0.17	1.85
6	1.58	0.42	-109.1	0.21	2.05
6.5	1.63	0.48	-100.3	0.28	2.31
7	1.68	0.53	-91	0.35	2.51
7.5	1.86	0.56	-80.2	0.48	2.87
8	1.96	0.59	-69.4	0.65	3.18
8.5	2.15	0.63	-58.6	0.85	3.61
9	2.26	0.64	-51.5	1.12	4.02
9.5	2.15	0.75	-42.4	1.4	4.49
10	2.32	0.74	-37.5	1.69	4.87

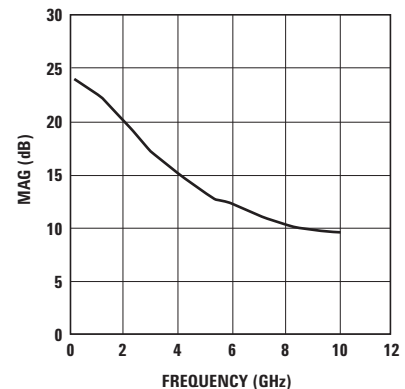

Figure 33. MAG vs. Frequency.

MGA-62563 Typical Scattering Parameters, $T_C = 25^\circ\text{C}$, $Z_0 = 50\Omega$, $V_d = 3\text{V}$, $I_{ds} = 20\text{mA}$

Freq. GHz	S_{11}		dB	S_{21}		S_{12}		S_{22}		K-factor
	Mag.	Ang.		Mag.	Ang.	Mag.	Ang.	Mag.	Ang.	
0.1	0.274	-53.949	20.92	11.121	157.035	0.054	5.715	0.094	-80.83	1.05
0.2	0.265	-60.28	20.67	10.806	154.512	0.054	5.383	0.09	-91.02	1.07
0.3	0.259	-67.514	20.39	10.459	151.71	0.054	5.086	0.089	-102.192	1.08
0.4	0.257	-75.557	20.08	10.093	148.613	0.054	4.833	0.091	-113.483	1.1
0.5	0.258	-84.672	19.72	9.687	144.952	0.054	4.637	0.095	-124.7	1.12
0.6	0.264	-93.431	19.37	9.304	141.158	0.054	4.525	0.101	-133.965	1.14
0.7	0.275	-102.057	19.02	8.932	137.004	0.054	4.504	0.109	-141.605	1.16
0.8	0.29	-110.18	18.67	8.581	132.446	0.054	4.576	0.118	-147.841	1.18
0.9	0.31	-117.309	18.35	8.271	127.543	0.054	4.783	0.129	-152.991	1.19
1	0.331	-123.571	18.04	7.983	122.588	0.054	5.195	0.139	-156.749	1.2
1.1	0.354	-129.682	17.71	7.679	117.464	0.054	5.763	0.15	-160.026	1.21
1.2	0.372	-134.998	17.38	7.396	112.827	0.054	6.374	0.16	-162.849	1.22
1.3	0.387	-138.974	17.04	7.11	108.473	0.055	7.105	0.163	-164.481	1.22
1.4	0.397	-142.056	16.69	6.828	104.388	0.055	7.939	0.16	-165.092	1.25
1.5	0.407	-145.03	16.33	6.555	100.473	0.056	8.736	0.157	-165.37	1.26
1.6	0.416	-148.334	15.97	6.289	96.786	0.057	9.514	0.152	-166.308	1.28
1.7	0.423	-151.951	15.6	6.025	93.017	0.058	10.294	0.146	-166.218	1.3
1.8	0.427	-155.37	15.25	5.789	89.657	0.059	10.984	0.141	-166.034	1.32
1.9	0.428	-158.764	14.91	5.568	86.471	0.06	11.651	0.137	-165.814	1.34
2	0.428	-161.995	14.59	5.365	83.402	0.062	12.246	0.132	-165.841	1.35
2.5	0.432	-177.573	13.16	4.549	68.702	0.07	13.701	0.098	-166.888	1.41
3	0.422	162.92	11.89	3.933	54.632	0.08	12.332	0.073	-164.868	1.45
3.5	0.453	148.816	10.89	3.503	40.096	0.092	7.985	0.024	-165.023	1.39
4	0.497	133.003	9.85	3.108	26.107	0.102	3.027	0.013	108.515	1.35
4.5	0.584	123.794	8.87	2.777	11.49	0.111	-3.486	0.044	23.417	1.24
5	0.648	108.792	7.8	2.455	-2.939	0.121	-9.998	0.044	61.186	1.15
5.5	0.705	99.614	6.75	2.174	-14.677	0.128	-17.142	0.019	83.666	1.05
6	0.729	87.836	6.32	2.07	-26.088	0.131	-23.178	0.129	125.118	1
6.5	0.719	79.179	5.46	1.875	-37.227	0.138	-30.431	0.194	108.15	1.06
7	0.709	67.879	5.33	1.847	-49.36	0.144	-36.508	0.289	94.828	1.06
7.5	0.69	56.687	4.54	1.686	-62.033	0.148	-43.977	0.312	79.896	1.17
8	0.682	46.564	4.15	1.613	-71.166	0.155	-50.351	0.321	72.003	1.19
9	0.725	27.786	3.57	1.508	-91.211	0.164	-66.308	0.344	49.405	1.11
10	0.791	15.826	3.07	1.424	-106.691	0.166	-79.9	0.382	25.395	1

Typical Noise Parameters at 25°C,

$T_C = 25^\circ\text{C}$, $Z_0 = 50\Omega$, $V_d = 3\text{V}$, $I_{ds} = 20\text{mA}$

Freq GHz	F_{min} dB	Γ_{opt} Mag.	Γ_{opt} Ang.	$R_n/50$	NF@50Ω dB
0.5	0.83	0.1	83.2	0.11	0.85
1	0.71	0.06	133.5	0.08	0.71
1.5	0.81	0.09	151.9	0.07	0.82
2	0.88	0.15	133.2	0.08	0.91
2.5	0.93	0.16	160.2	0.08	0.97
3	0.98	0.23	179.7	0.07	1.07
3.5	1.1	0.24	-164.5	0.08	1.2
4	1.2	0.28	-154	0.09	1.36
4.5	1.29	0.33	-143.9	0.1	1.52
5	1.4	0.36	-132.8	0.12	1.71
5.5	1.46	0.4	-122.9	0.16	1.88
6	1.62	0.42	-112	0.21	2.1
6.5	1.68	0.47	-102.3	0.28	2.34
7	1.74	0.52	-92.9	0.35	2.56
7.5	1.92	0.55	-82.2	0.47	2.91
8	2.04	0.57	-71.5	0.65	3.23
8.5	2.22	0.61	-60	0.85	3.65
9	2.32	0.65	-52.5	1.13	4.09
9.5	2.2	0.75	-43.5	1.41	4.55
10	2.39	0.74	-38.6	1.71	4.94

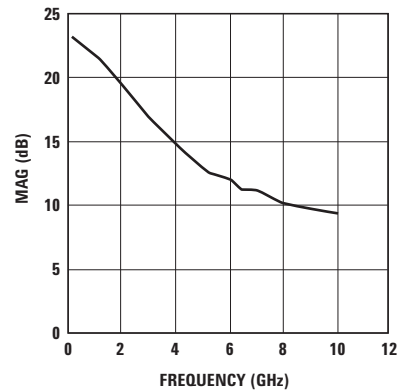

Figure 34. MAG vs. Frequency.

MGA-62563 Typical Scattering Parameters, $T_C = 25^\circ\text{C}$, $Z_0 = 50\Omega$, $V_d = 5\text{V}$, $I_{ds} = 40\text{mA}$

Freq. GHz	S ₁₁		dB	S ₂₁		S ₁₂		S ₂₂		K-factor
	Mag.	Ang.		Mag.	Ang.	Mag.	Ang.	Mag.	Ang.	
0.1	0.22	-62.539	22.22	12.911	155.715	0.046	2.6	0.041	-117.254	1.09
0.2	0.214	-69.644	21.94	12.502	153.158	0.045	2.081	0.038	-129.6	1.12
0.3	0.212	-77.541	21.62	12.057	150.317	0.045	1.608	0.038	-142.653	1.14
0.4	0.214	-86.029	21.28	11.588	147.183	0.044	1.201	0.039	-155.322	1.18
0.5	0.22	-95.298	20.89	11.075	143.514	0.043	0.89	0.041	-167.419	1.23
0.6	0.229	-103.863	20.5	10.59	139.683	0.043	0.698	0.043	-177.186	1.26
0.7	0.243	-112.001	20.1	10.12	135.429	0.042	0.643	0.045	174.82	1.31
0.8	0.259	-119.5	19.71	9.675	130.731	0.041	0.734	0.047	168.782	1.37
0.9	0.279	-125.972	19.35	9.281	125.639	0.041	1.042	0.048	164.393	1.4
1	0.299	-131.628	19	8.911	120.513	0.04	1.762	0.049	163.524	1.45
1.1	0.32	-137.177	18.61	8.521	115.245	0.039	2.85	0.048	164.901	1.51
1.2	0.336	-142.073	18.23	8.159	110.507	0.039	4.1	0.049	167.544	1.55
1.3	0.348	-145.665	17.84	7.801	106.06	0.039	5.603	0.043	170.928	1.59
1.4	0.356	-148.38	17.45	7.455	101.898	0.039	7.304	0.032	178.48	1.64
1.5	0.363	-150.989	17.05	7.121	97.936	0.039	9.091	0.024	-165.089	1.7
1.6	0.37	-154.012	16.65	6.8	94.219	0.039	10.88	0.019	-143.445	1.75
1.7	0.374	-157.396	16.23	6.481	90.464	0.04	12.735	0.02	-106.9	1.78
1.8	0.376	-160.639	15.85	6.2	87.131	0.04	14.442	0.027	-86.207	1.84
1.9	0.376	-163.914	15.47	5.939	83.969	0.041	16.084	0.035	-75.973	1.87
2	0.375	-167.082	15.12	5.699	80.94	0.042	17.612	0.043	-70.287	1.9
2.5	0.372	177.387	13.51	4.736	66.672	0.05	22.955	0.081	-58.59	1.9
3	0.356	158.01	12.14	4.047	53.37	0.059	24.196	0.112	-56.813	1.89
3.5	0.381	144.376	11.06	3.573	39.369	0.07	21.054	0.14	-52.546	1.75
4	0.423	129.789	10.03	3.175	25.905	0.08	17.196	0.146	-53.692	1.66
4.5	0.508	121.918	9.07	2.842	11.472	0.09	11.517	0.155	-54.803	1.49
5	0.576	107.907	8.06	2.528	-2.535	0.102	5.225	0.123	-67.978	1.35
5.5	0.639	99.362	7.06	2.255	-14.4	0.11	-2.316	0.122	-90.136	1.23
6	0.672	88.277	6.69	2.16	-25.888	0.122	-8.464	0.105	-150.094	1.1
6.5	0.672	79.728	5.92	1.976	-37.199	0.125	-15.947	0.121	162.804	1.18
7	0.668	68.454	5.81	1.953	-49.487	0.135	-22.415	0.187	127.855	1.15
7.5	0.657	57.275	5.12	1.803	-62.284	0.142	-30.896	0.213	108.129	1.22
8	0.655	47.003	4.75	1.728	-71.76	0.151	-38.436	0.231	98.412	1.2
9	0.704	28.227	4.24	1.629	-91.789	0.161	-55.934	0.261	73.264	1.09
10	0.772	16.7	3.85	1.558	-107.404	0.162	-68.84	0.298	44.421	0.98

Typical Noise Parameters at 25°C,

$T_C = 25^\circ\text{C}$, $Z_0 = 50\Omega$, $V_d = 5\text{V}$, $I_{ds} = 40\text{mA}$

Freq GHz	F _{min} dB	Γ_{opt} Mag.	Γ_{opt} Ang.	R _{n/50}	NF@50Ω dB
0.5	0.75	0.05	89.7	0.1	0.75
1	0.67	0.06	157.9	0.08	0.67
1.5	0.78	0.1	174	0.07	0.79
2	0.87	0.13	147.1	0.08	0.9
2.5	0.95	0.15	174.2	0.08	0.98
3	0.98	0.22	-169.9	0.08	1.07
3.5	1.1	0.23	-153.6	0.09	1.2
4	1.25	0.26	-146.3	0.1	1.4
4.5	1.33	0.31	-138.5	0.12	1.54
5	1.42	0.36	-127.2	0.14	1.73
5.5	1.44	0.4	-117.8	0.18	1.88
6	1.61	0.43	-107.4	0.22	2.1
6.5	1.66	0.48	-97.8	0.3	2.36
7	1.7	0.53	-89.1	0.38	2.57
7.5	1.92	0.56	-78.4	0.51	2.94
8	2.03	0.58	-68.2	0.69	3.27
8.5	2.21	0.62	-57.2	0.91	3.7
9	2.34	0.65	-50.2	1.18	4.15
9.5	2.23	0.75	-41.6	1.48	4.64
10	2.43	0.75	-36.6	1.8	5.06

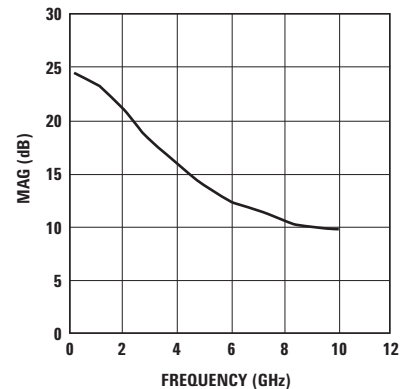

Figure 35. MAG vs. Frequency.

MGA-62563 Typical Scattering Parameters, $T_C = 25^\circ\text{C}$, $Z_0 = 50\Omega$, $V_d = 5\text{V}$, $I_{ds} = 30\text{mA}$

Freq. GHz	S_{11}		dB	S_{21}		S_{12}		S_{22}		K-factor
	Mag.	Ang.		Mag.	Ang.	Mag.	Ang.	Mag.	Ang.	
0.1	0.237	-58.467	21.8	12.306	156.126	0.048	2.335	0.051	-78.66	1.09
0.2	0.23	-65.183	21.53	11.928	153.564	0.048	1.765	0.045	-87.521	1.11
0.3	0.227	-72.749	21.23	11.518	150.716	0.047	1.228	0.039	-99.059	1.14
0.4	0.226	-81.026	20.89	11.082	147.575	0.047	0.749	0.036	-112.979	1.16
0.5	0.23	-90.235	20.51	10.603	143.898	0.046	0.336	0.033	-129.188	1.21
0.6	0.238	-98.902	20.13	10.153	140.036	0.046	0.043	0.033	-143.928	1.24
0.7	0.25	-107.258	19.75	9.716	135.78	0.045	-0.127	0.034	-156.168	1.28
0.8	0.265	-115.042	19.37	9.304	131.095	0.044	-0.173	0.036	-165.43	1.33
0.9	0.284	-121.835	19.03	8.94	126.04	0.043	-0.043	0.039	-171.896	1.38
1	0.304	-127.797	18.69	8.602	120.95	0.043	0.462	0.041	-173.502	1.4
1.1	0.325	-133.627	18.32	8.246	115.706	0.042	1.306	0.044	-172.856	1.46
1.2	0.342	-138.742	17.97	7.914	110.976	0.042	2.313	0.047	-171.524	1.48
1.3	0.354	-142.508	17.6	7.583	106.528	0.042	3.581	0.044	-166.973	1.52
1.4	0.363	-145.389	17.22	7.259	102.357	0.041	5.063	0.038	-156.713	1.6
1.5	0.371	-148.151	16.83	6.946	98.374	0.041	6.652	0.034	-141.923	1.64
1.6	0.378	-151.305	16.45	6.644	94.631	0.042	8.268	0.032	-127.89	1.66
1.7	0.383	-154.816	16.04	6.342	90.832	0.042	9.963	0.034	-108.748	1.72
1.8	0.386	-158.161	15.67	6.075	87.455	0.043	11.558	0.039	-95.871	1.74
1.9	0.386	-161.511	15.31	5.827	84.258	0.043	13.115	0.045	-87.243	1.8
2	0.385	-164.738	14.96	5.6	81.188	0.044	14.587	0.052	-81.336	1.83
2.5	0.383	179.495	13.41	4.684	66.72	0.051	19.968	0.083	-65.882	1.86
3	0.368	159.885	12.09	4.023	53.234	0.06	21.459	0.111	-61.634	1.85
3.5	0.393	145.917	11.05	3.568	39.154	0.071	18.676	0.136	-55.813	1.72
4	0.435	130.892	10.05	3.179	25.626	0.081	15.046	0.14	-56.384	1.62
4.5	0.52	122.592	9.11	2.854	11.264	0.09	9.563	0.148	-56.648	1.46
5	0.588	108.322	8.1	2.541	-2.66	0.102	3.467	0.117	-69.997	1.32
5.5	0.65	99.592	7.11	2.266	-14.387	0.11	-3.953	0.117	-92.334	1.2
6	0.682	88.363	6.72	2.167	-25.768	0.122	-10.031	0.106	-153.954	1.07
6.5	0.68	79.738	5.93	1.979	-36.871	0.125	-17.411	0.125	160.43	1.16
7	0.675	68.426	5.8	1.949	-49	0.134	-23.769	0.193	126.821	1.14
7.5	0.663	57.213	5.06	1.791	-61.602	0.141	-32.118	0.218	107.343	1.21
8	0.659	46.972	4.67	1.711	-70.948	0.15	-39.536	0.236	97.607	1.21
9	0.707	28.23	4.07	1.597	-90.845	0.16	-56.781	0.265	72.633	1.11
10	0.774	16.694	3.6	1.513	-106.409	0.161	-69.865	0.303	44.117	1

Typical Noise Parameters at 25°C,

$T_C = 25^\circ\text{C}$, $Z_0 = 50\Omega$, $V_d = 5\text{V}$, $I_{ds} = 30\text{mA}$

Freq GHz	F_{min}	Γ_{opt}	Γ_{opt}	$R_n/50$	NF@50Ω dB
	dB	Mag.	Ang.		
0.5	0.77	0.08	83.8	0.11	0.78
1	0.67	0.05	149.4	0.08	0.68
1.5	0.79	0.09	168.8	0.07	0.8
2	0.87	0.13	142.3	0.08	0.9
2.5	0.95	0.14	169.1	0.08	0.98
3	0.98	0.22	-173.6	0.08	1.06
3.5	1.09	0.23	-159.3	0.08	1.19
4	1.21	0.26	-148.7	0.1	1.35
4.5	1.29	0.31	-140.3	0.11	1.51
5	1.39	0.35	-129.6	0.13	1.68
5.5	1.42	0.39	-120.3	0.17	1.82
6	1.58	0.41	-109.2	0.21	2.03
6.5	1.62	0.47	-100	0.28	2.28
7	1.68	0.52	-90.7	0.35	2.49
7.5	1.88	0.55	-79.9	0.48	2.85
8	2	0.57	-69.8	0.65	3.17
8.5	2.17	0.62	-58.8	0.85	3.59
9	2.3	0.64	-51.3	1.12	4.03
9.5	2.25	0.72	-42.6	1.41	4.48
10	2.37	0.74	-37.8	1.7	4.91

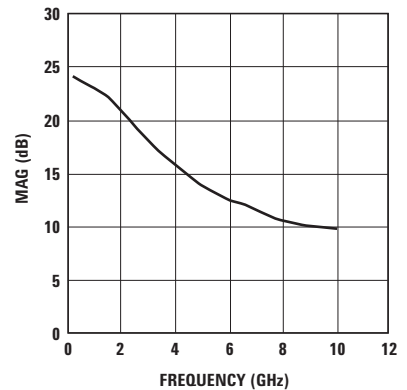

Figure 36. MAG vs. Frequency.

MGA-62563 Typical Scattering Parameters, $T_C = 25^\circ\text{C}$, $Z_0 = 50\Omega$, $V_d = 5\text{V}$, $I_{ds} = 20\text{ mA}$

Freq. GHz	S_{11}		S_{21}			S_{12}		S_{22}		K-factor
	Mag.	Ang.	dB	Mag.	Ang.	Mag.	Ang.	Mag.	Ang.	
0.1	0.276	-50.781	20.99	11.213	156.884	0.053	3.086	0.093	-52.766	1.07
0.2	0.266	-56.676	20.74	10.894	154.329	0.053	2.41	0.083	-58.024	1.09
0.3	0.259	-63.497	20.46	10.544	151.483	0.052	1.753	0.074	-64.698	1.12
0.4	0.255	-71.17	20.15	10.174	148.356	0.052	1.131	0.065	-72.808	1.14
0.5	0.254	-80.022	19.79	9.763	144.671	0.051	0.542	0.058	-83.072	1.18
0.6	0.257	-88.677	19.44	9.375	140.845	0.051	0.052	0.052	-94.078	1.2
0.7	0.265	-97.315	19.08	8.997	136.657	0.05	-0.34	0.05	-105.431	1.24
0.8	0.277	-105.608	18.73	8.641	132.057	0.05	-0.641	0.05	-116.715	1.27
0.9	0.294	-113.01	18.41	8.327	127.118	0.049	-0.769	0.052	-126.861	1.31
1	0.313	-119.584	18.1	8.038	122.134	0.049	-0.568	0.056	-133.663	1.32
1.1	0.332	-125.983	17.77	7.732	117	0.048	-0.093	0.062	-138.752	1.36
1.2	0.349	-131.536	17.44	7.446	112.349	0.048	0.54	0.067	-142.695	1.38
1.3	0.362	-135.667	17.09	7.154	107.971	0.047	1.412	0.068	-141.888	1.43
1.4	0.371	-138.843	16.73	6.864	103.851	0.047	2.497	0.066	-137.128	1.47
1.5	0.38	-141.9	16.37	6.583	99.905	0.047	3.676	0.065	-131.552	1.51
1.6	0.389	-145.323	16	6.311	96.172	0.047	4.908	0.063	-126.926	1.55
1.7	0.394	-149.051	15.62	6.037	92.39	0.047	6.242	0.063	-119.49	1.6
1.8	0.397	-152.57	15.26	5.794	89.022	0.048	7.499	0.065	-113.329	1.62
1.9	0.397	-156.063	14.91	5.566	85.817	0.048	8.774	0.067	-107.935	1.68
2	0.396	-159.406	14.58	5.357	82.739	0.049	10.021	0.07	-103.352	1.7
2.5	0.395	-175.583	13.08	4.508	68.14	0.055	14.801	0.083	-84.66	1.78
3	0.38	164.391	11.79	3.888	54.386	0.063	16.272	0.102	-74.77	1.81
3.5	0.407	149.754	10.77	3.454	40.091	0.074	13.807	0.118	-63.62	1.7
4	0.449	133.82	9.76	3.075	26.308	0.083	10.436	0.118	-61.976	1.63
4.5	0.534	124.633	8.8	2.753	11.752	0.092	5.262	0.123	-58.73	1.47
5	0.6	109.771	7.78	2.448	-2.529	0.104	-0.451	0.093	-72.766	1.33
5.5	0.661	100.709	6.77	2.179	-14.499	0.111	-7.532	0.097	-96.992	1.22
6	0.692	89.216	6.37	2.083	-26.054	0.122	-13.423	0.102	-166.868	1.09
6.5	0.688	80.407	5.56	1.897	-37.379	0.125	-20.653	0.134	151.132	1.18
7	0.681	69.043	5.43	1.868	-49.653	0.134	-26.784	0.209	121.656	1.16
7.5	0.666	57.717	4.69	1.716	-62.476	0.141	-34.82	0.234	103.118	1.24
8	0.661	47.473	4.3	1.641	-71.899	0.149	-41.982	0.25	93.688	1.24
9	0.708	28.579	3.73	1.537	-92	0.159	-58.934	0.278	69.322	1.13
10	0.774	16.789	3.28	1.459	-107.719	0.161	-72.037	0.315	41.449	1.02

Typical Noise Parameters at 25°C ,

$T_C = 25^\circ\text{C}$, $Z_0 = 50\Omega$, $V_d = 5\text{V}$, $I_{ds} = 20\text{ mA}$

Freq GHz	F_{min} dB	Γ_{opt} Mag.	Γ_{opt} Ang.	$R_n/50$	NF@50Ω dB
0.5	0.81	0.1	90	0.11	0.83
1	0.7	0.05	129.3	0.08	0.71
1.5	0.82	0.08	150.1	0.08	0.83
2	0.9	0.13	132.1	0.08	0.92
2.5	0.94	0.15	158.4	0.08	0.98
3	0.98	0.22	180	0.07	1.06
3.5	1.1	0.23	-165	0.08	1.19
4	1.19	0.27	-153.6	0.09	1.34
4.5	1.28	0.31	-144.2	0.1	1.49
5	1.39	0.35	-132.9	0.12	1.66
5.5	1.42	0.39	-122.5	0.16	1.81
6	1.58	0.4	-112	0.2	2.01
6.5	1.64	0.46	-102.7	0.27	2.26
7	1.7	0.51	-93.5	0.33	2.47
7.5	1.9	0.54	-82.5	0.45	2.82
8	1.99	0.57	-71.3	0.62	3.15
8.5	2.17	0.6	-60.2	0.82	3.54
9	2.3	0.63	-52.6	1.09	3.98
9.5	2.11	0.75	-44	1.36	4.45
10	2.41	0.73	-38.5	1.67	4.85

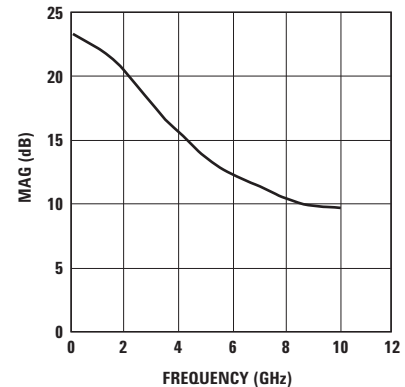

Figure 37. MAG vs. Frequency.

Refer to Avago Technologies Web Site for S-parameters at different biases. www.avagotech.com/view/rf

Device Models, Refer to Avago Technologies Web Site www.avagotech.com/view/rf

Ordering Information

Part Number	No. of Devices	Container
MGA-62563-TR1G	3000	7" Reel
MGA-62563-TR2G	10000	13" Reel
MGA-62563-BLKG	100	antistatic bag

SOT-363/SC-70 (JEDEC DFP-N) Package Dimensions

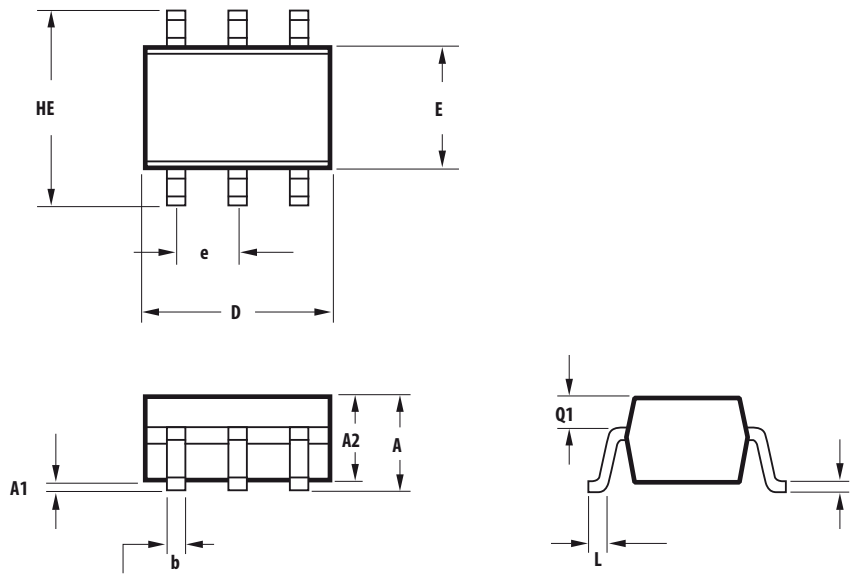

SYMBOL	DIMENSIONS (mm)	
	MIN.	MAX.
E	1.15	1.35
D	1.80	2.25
HE	1.80	2.40
A	0.80	1.10
A2	0.80	1.00
A1	0.00	0.10
Q1	0.10	0.40
e	0.650 BCS	
b	0.15	0.30
c	0.10	0.20
L	0.10	0.30

NOTES:

1. All dimensions are in mm.
2. Dimensions are inclusive of plating.
3. Dimensions are exclusive of mold flash & metal burr.
4. All specifications comply to EIAJ SC70.
5. Die is facing up for mold and facing down for trim/form, ie: reverse trim/form.
6. Package surface to be mirror finish.

Device Orientation

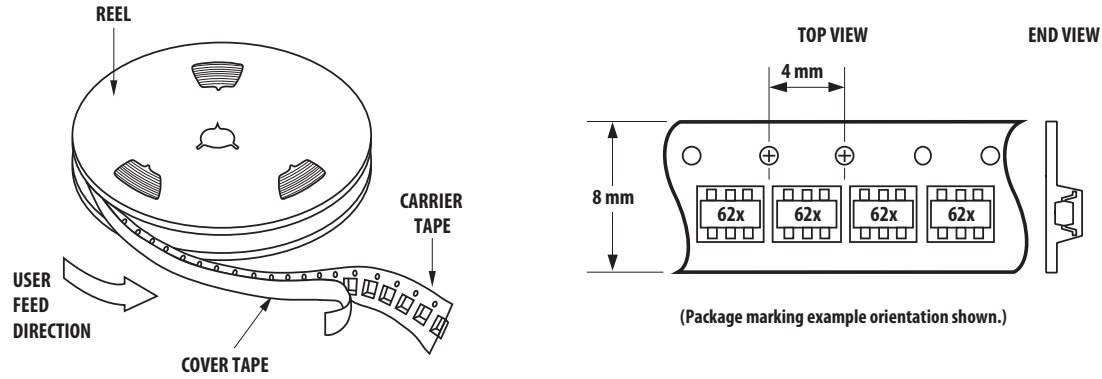

Tape Dimensions

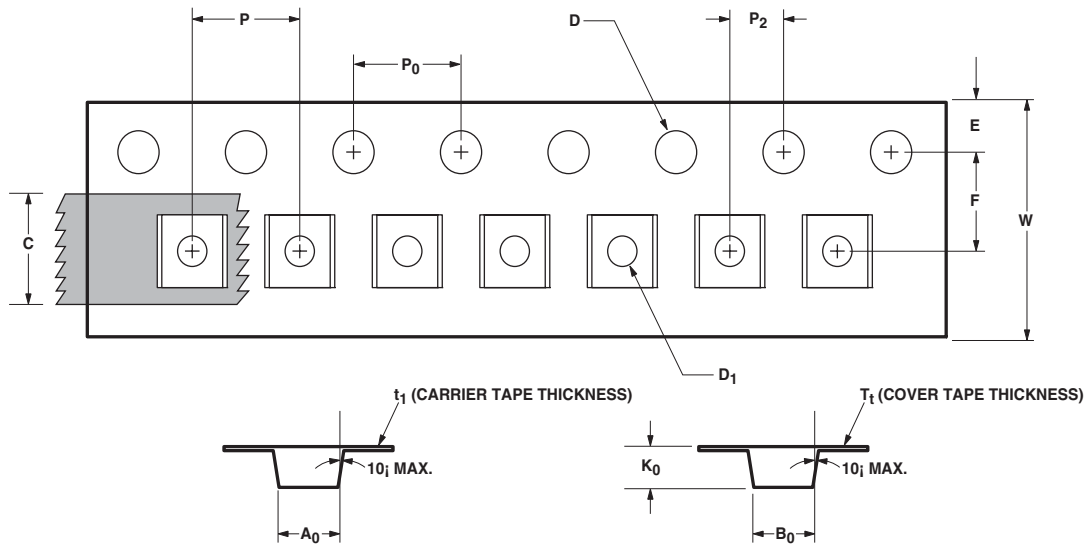

DESCRIPTION		SYMBOL	SIZE (mm)	SIZE (INCHES)
CAVITY	LENGTH	A ₀	2.40 ± 0.10	0.094 ± 0.004
	WIDTH	B ₀	2.40 ± 0.10	0.094 ± 0.004
	DEPTH	K ₀	1.20 ± 0.10	0.047 ± 0.004
	PITCH	P	4.00 ± 0.10	0.157 ± 0.004
	BOTTOM HOLE DIAMETER	D ₁	1.00 + 0.25	0.039 + 0.010
PERFORATION	DIAMETER	D	1.50 ± 0.10	0.061 ± 0.002
	PITCH	P ₀	4.00 ± 0.10	0.157 ± 0.004
	POSITION	E	1.75 ± 0.10	0.069 ± 0.004
CARRIER TAPE	WIDTH	W	8.00 ± 0.30 - 0.10	0.315 ± 0.012
	THICKNESS	t ₁	0.254 ± 0.02	0.010 ± 0.0005
COVER TAPE	WIDTH	C	5.40 ± 0.10	0.205 ± 0.004
	TAPE THICKNESS	T _t	0.062 ± 0.001	0.0025 ± 0.00004
DISTANCE	CAVITY TO PERFORATION (WIDTH DIRECTION)	F	3.50 ± 0.05	0.138 ± 0.002
	CAVITY TO PERFORATION (LENGTH DIRECTION)	P ₂	2.00 ± 0.05	0.079 ± 0.002

For product information and a complete list of distributors, please go to our web site: www.avagotech.com

Avago, Avago Technologies, and the A logo are trademarks of Avago Technologies in the United States and other countries. Data subject to change. Copyright © 2005-2010 Avago Technologies. All rights reserved. Obsoletes AV01-0642EN AV02-1237EN - July 30, 2010

AVAGO
TECHNOLOGIES