

# MGA-68563

## Current-Adjustable, Low Noise Amplifier



## Data Sheet

### Description

Avago Technologies MGA-68563 is an economical, easy-to-use GaAs MMIC amplifier that offers excellent linearity and low noise figure for applications from 0.1 to 1.5 GHz. Packaged in an miniature SOT-363 package, it requires half the board space of a SOT-143 package.

One external resistor is used to set the bias current from 5mA to 30mA. This allows the designer to use the same part in several circuit positions and tailor the linearity performance (and current consumption) to suit each position.

The output of the amplifier is matched to  $50\Omega$  (below 2:1 VSWR) across the entire bandwidth and only requires minimum input matching. The amplifier allows a wide dynamic range by offering a 1.0 dB NF coupled with a +20 dBm Output IP3. The circuit uses state-of-the-art E-pHEMT technology with proven reliability. On-chip bias circuitry allows operation from a single +3V power supply, while internal feedback ensures stability ( $K > 1$ ) over all frequencies for Id at 10mA and above.

### Applications

- LNA for DVB-T, DVB-H, T-DMB, ISDB-T, DAB and Media-FLO

### Features

- Single +3V supply
- High linearity
- Low noise figure
- Miniature package
- Unconditionally stable

### Specifications at 500 MHz; 3V, 10 mA (Typ.)

- 1.0 dB noise figure
- 20 dBm OIP3
- 19.7 dB gain
- \* This represents what Avago Technologies has managed to achieve on a device level with trade off between optimal NF, Gain, OIP3 and input return loss.



**Attention: Observe precautions for handling electrostatic sensitive devices.**  
ESD Machine Model (Class A)  
ESD Human Body Model (Class 1A)  
*Refer to Agilent Application Note A004R: Electrostatic Discharge Damage and Control.*

## Pin Connections and Package Marking

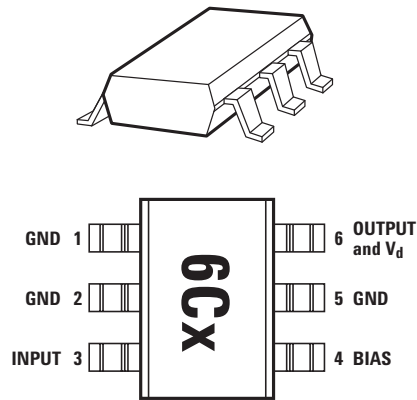

Note:  
Package marking provides orientation and identification:  
"6C" = Device Code  
"X" = Date code indicates the month of manufacture.

## Simplified Schematic

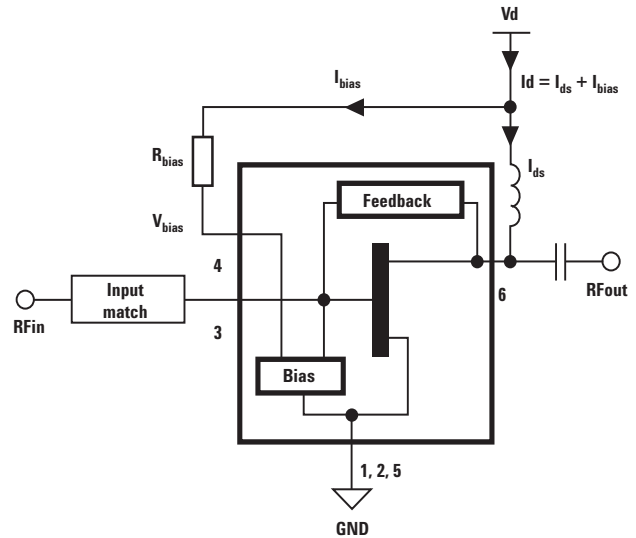

## MGA-68563 Absolute Maximum Ratings<sup>[1]</sup>

Symbol	Parameter	Units	Absolute Maximum
$V_d$	Device Voltage (pin 6) <sup>[2]</sup>	V	6
$I_d$	Device Current (pin 6) <sup>[2]</sup>	mA	100
$P_{in}$	CW RF Input (pin3)		
	( $V_d=3V, I_d=10mA$ ) <sup>[3]</sup> ( $V_d=0V, I_d=0mA$ )	dBm dBm	21 21
$I_{ref}$	Bias Reference Current (pin 4)	mA	1
$P_{diss}$	Total Power Dissipation <sup>[4]</sup>	mW	600
$T_{CH}$	Channel Temperature	°C	150
$T_{STG}$	Storage Temperature	°C	150
$\theta_{ch\_b}$	Thermal Resistance <sup>[5]</sup>	°C/W	97

Notes:

1. Operation of this device above any one of these parameters may cause permanent damage.
2. Bias is assumed at DC quiescent conditions.
3. With the DC (typical bias) and RF applied to the device at board temperature  $T_B = 25^\circ\text{C}$ .
4. Total dissipation power is referred to lead "5" temperature.  $T_c=92^\circ\text{C}$ , derate  $P_{diss}$  at  $10.3\text{mW}/^\circ\text{C}$  for  $T_c > 92^\circ\text{C}$ .
5. Thermal resistance measured using  $150^\circ\text{C}$  Liquid Crystal Measurement method.

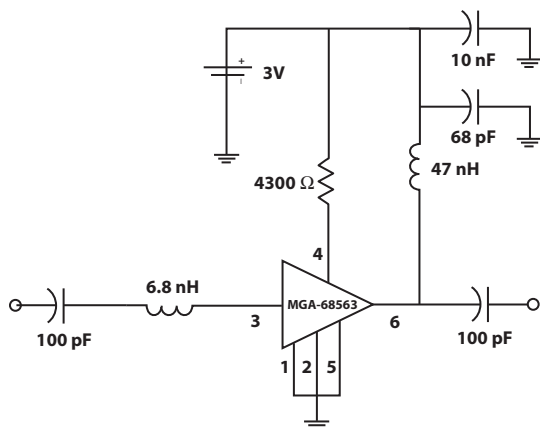

Figure 1a. Test circuit of the 0.5 GHz production test board used for NF, Gain and OIP3 measurements. This circuit achieves a trade-off between optimal NF, Gain, OIP3 and input return loss. Circuit losses have been de-embedded from actual measurements.

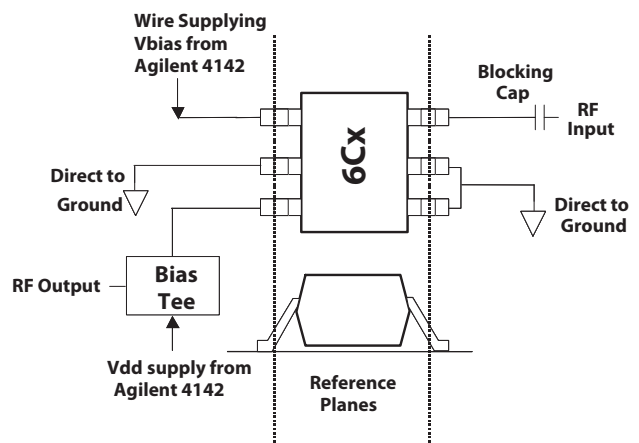

Figure 1b. A diagram showing the connection to the DUT during an S and Noise parameter measurement using an automated tuner system.

## MGA-68563 Electrical Specifications

$T_C = 25^\circ\text{C}$ ,  $Z_O = 50\Omega$ ,  $V_d = 3\text{V}$  (unless otherwise specified)

Symbol	Parameters and Test Conditions	Freq	Units	Min.	Typ.	Max.
$I_d^{[1,2]}$	Device Current		mA		11	16
$NF_{\text{test}}^{[1,2]}$	Noise Figure in test circuit <sup>[1]</sup>	f = 0.5 GHz	dB		1.0	1.4
$G_{\text{test}}^{[1,2]}$	Associated Gain in test circuit <sup>[1]</sup>	f = 0.5 GHz	dB	18	19.7	21.5
$OIP3_{\text{test}}^{[1,2]}$	Output 3 <sup>rd</sup> Order Intercept in test circuit <sup>[1]</sup>	f = 0.5 GHz	dBm	18	20.7	
$P1dB_{\text{test}}^{[1,2]}$	Output Power at 1dB Gain Compression in test circuit. <sup>[1]</sup>	f = 0.5 GHz	dBm			17.5

Notes:

- Guaranteed specifications are 100% tested in the production test circuit, the typical value is based on measurement of at least 600 parts from two non-consecutive wafer lots during initial characterization of this product.
- Circuit achieved a trade-off between optimal NF, Gain, OIP3 and input return loss.

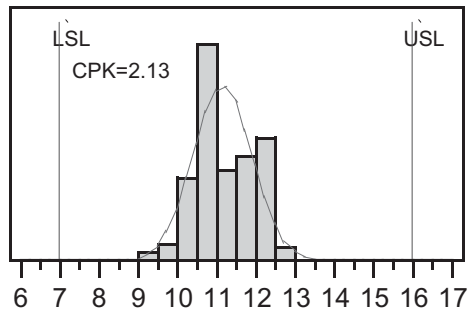

Figure 2.  $I_d$  @ 3V. LSL=7, Nominal=11, USL=16

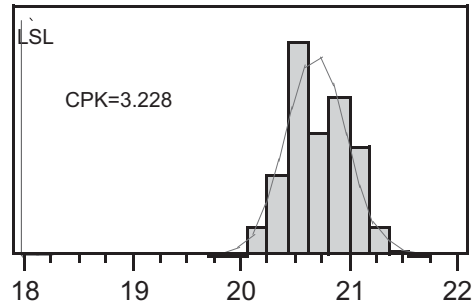

Figure 3. OIP3 @ 0.5GHz 3V. LSL=18, Nominal=20.7

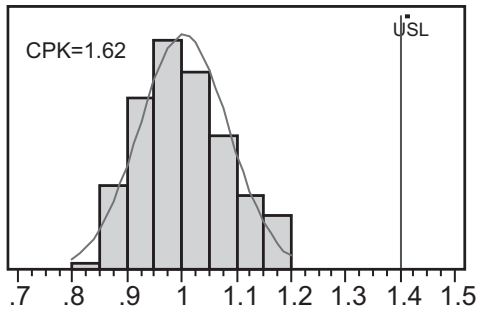

Figure 4. NF @ 0.5GHz 3V. USL=1.4, Nominal=1.0

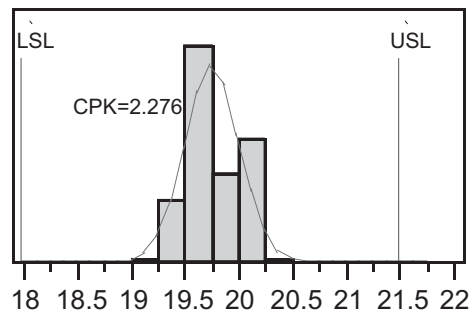

Figure 5. Gain @ 0.5GHz 3V. USL=18, Nominal=19.7, USL=21.5

Note:

Measured on the production circuit.

Distribution data sample size is 600 samples taken from 2 non-consecutive wafer lots. Future wafers allocated to this product may have nominal values anywhere between upper and lower limits.

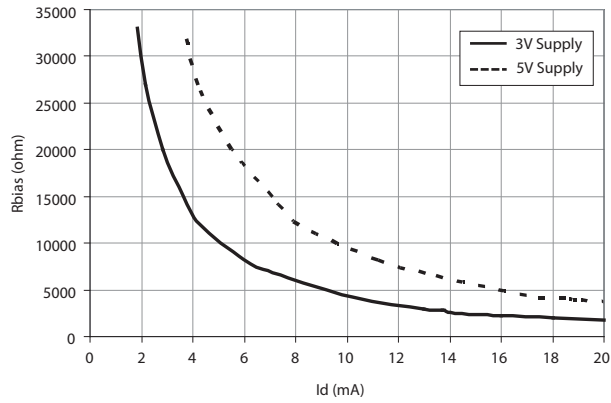

Figure 6. Rbias vs Id (3V Supply and 5V Supply)

**MGA-68563 Typical Performance, Vd = 3V, Ids (q) = 5mA at 50ohm Input and Output**

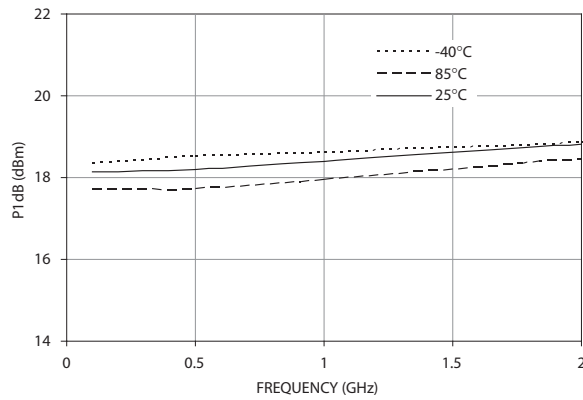

Figure 7. P1dB vs. Frequency (3V,5mA), Ids=5mA during small signal, i.e. Pin=-20dBm)

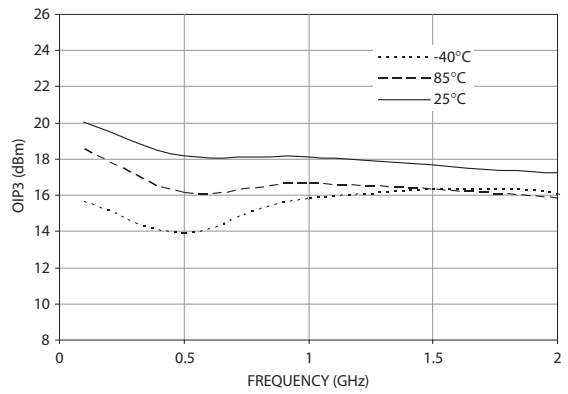

Figure 8. OIP3 vs. Frequency (3V 5mA)

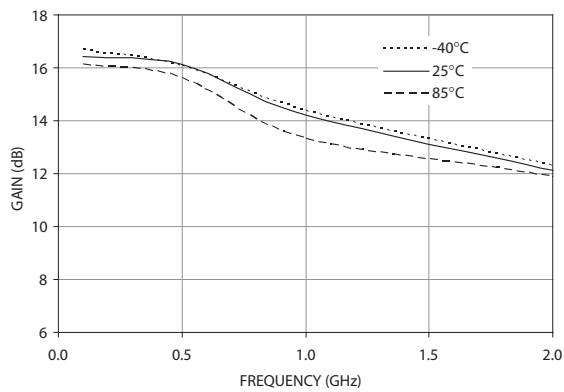

Figure 9. Gain vs. Frequency (3V 5mA)

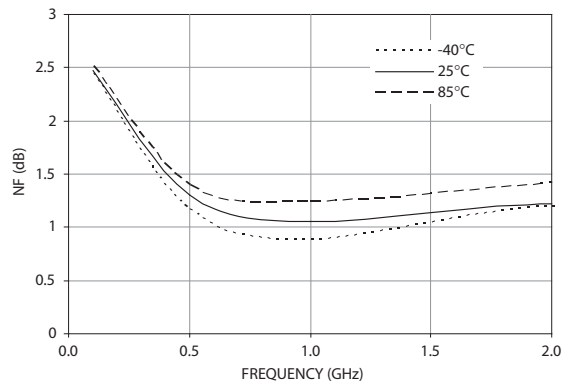

Figure 10. NF vs. Frequency (3V 5mA)

Notes:

1. Ids taken @ ambient temperature of 25°C may change with temperature variation.
2. Bias current (Ids) for the above charts are quiescent conditions. Actual level may increase or decrease depending on amount of RF drive.

## MGA-68563 Typical Performance, $V_d = 3V$ , $I_{ds}(q) = 10mA$ at 50ohm Input and Output

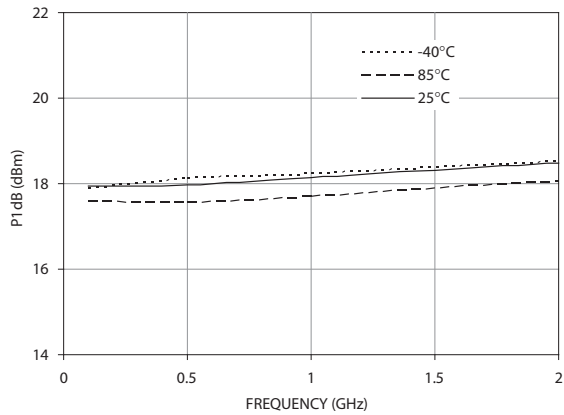

Figure 11. P1dB vs. Frequency (3V,10mA),  $I_{ds}=10mA$  during small signal, i.e.  $P_{in}=-20dBm$

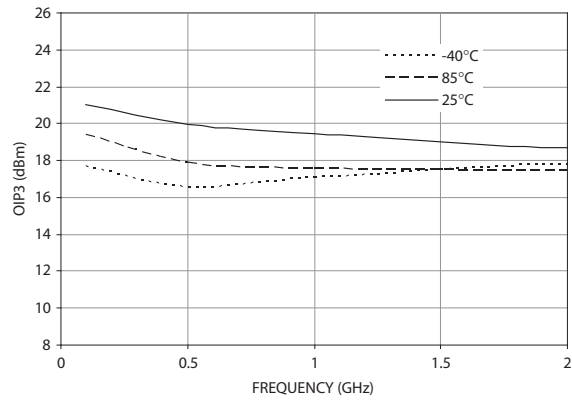

Figure 12. OIP3 vs. Frequency (3V 10mA)

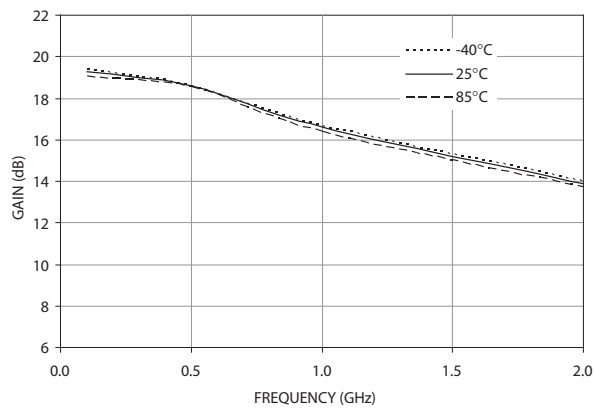

Figure 13. Gain vs. Frequency (3V 10mA)

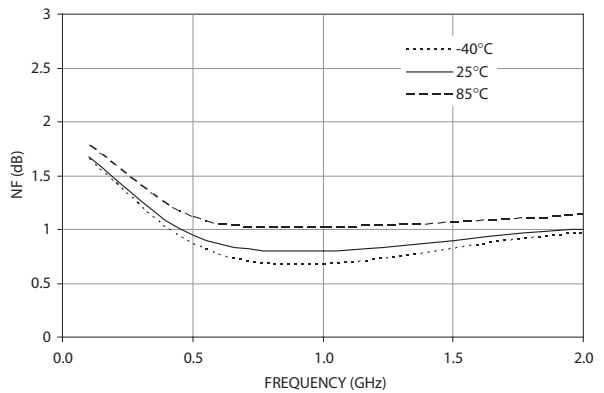
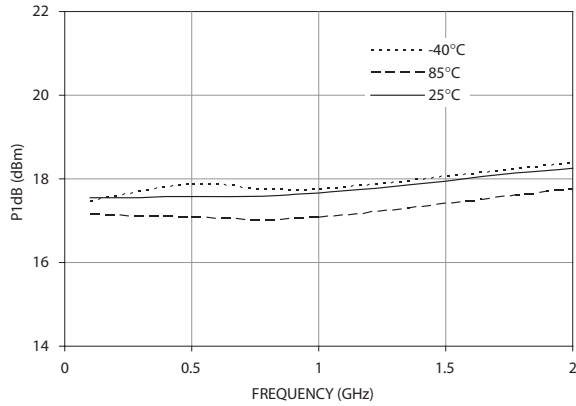

Figure 14. NF vs. Frequency (3V 10mA)

### Notes:

1.  $I_{ds}$  taken @ ambient temperature of 25°C may change with temperature variation.
2. Bias current ( $I_{ds}$ ) for the above charts are quiescent conditions. Actual level may increase or decrease depending on amount of RF drive.

**MGA-68563 Typical Performance, Vd = 3V, Ids (q) = 15mA at 50ohm Input and Output**



**Figure 15. P1dB vs. Frequency (3V,15mA), Ids=15mA during small signal, i.e. Pin=-20dBm)**

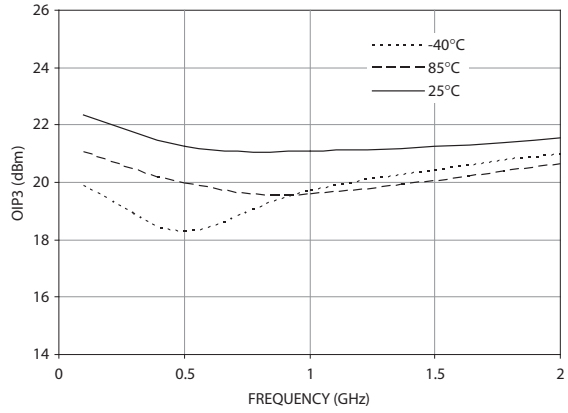

**Figure 16. OIP3 vs. Frequency (3V 15mA)**

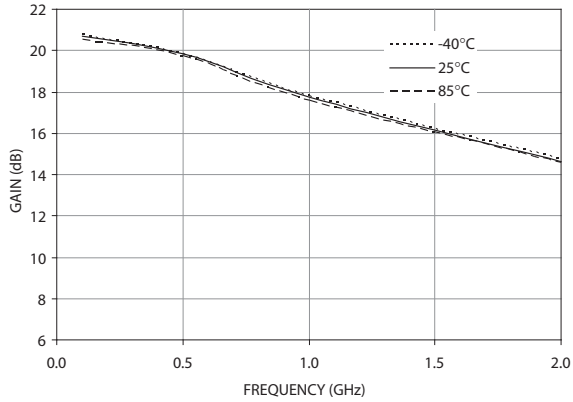

**Figure 17. Gain vs. Frequency (3V 15mA)**

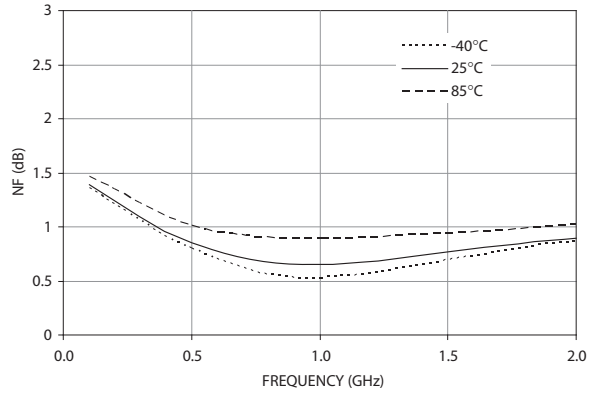

**Figure 18. NF vs. Frequency (3V 15mA)**

**Notes:**

1. Ids taken @ ambient temperature of 25°C may change with temperature variation.
2. Bias current (Ids) for the above charts are quiescent conditions. Actual level may increase or decrease depending on amount of RF drive.

## MGA-68563 Typical Performance, $V_d = 5V$ , $I_{ds}(q) = 5mA$ at 50ohm Input and Output

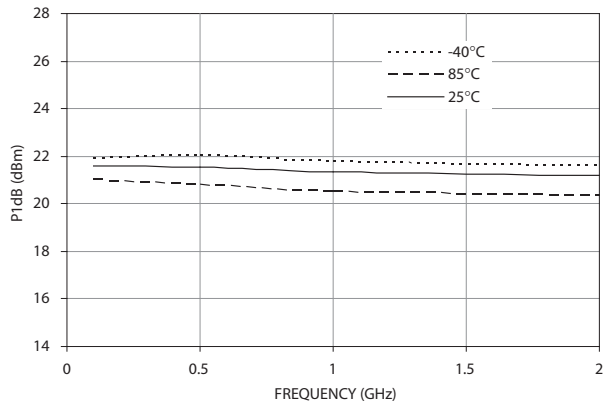

Figure 19. P1dB vs. Frequency (5V,5mA),  $I_{ds}=5mA$  during small signal, i.e.  $P_{in}=-20dBm$

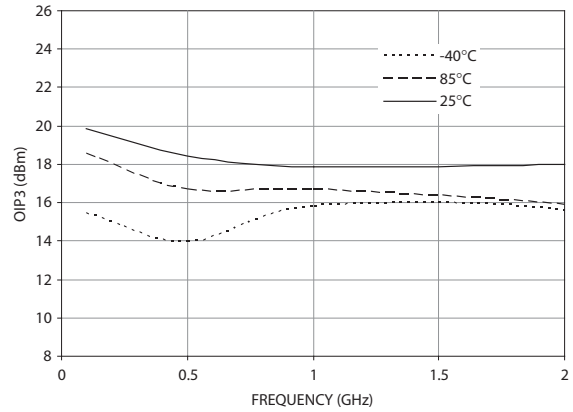

Figure 20. OIP3 vs. Frequency (5V 5mA)

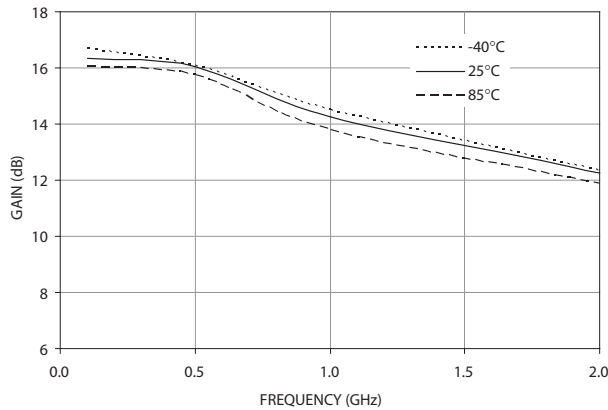

Figure 21. Gain vs. Frequency (5V 5mA)

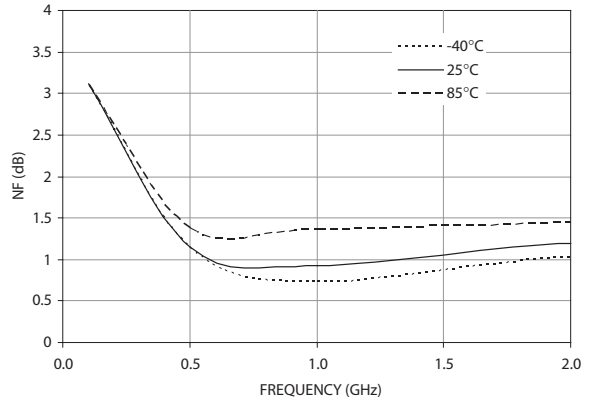
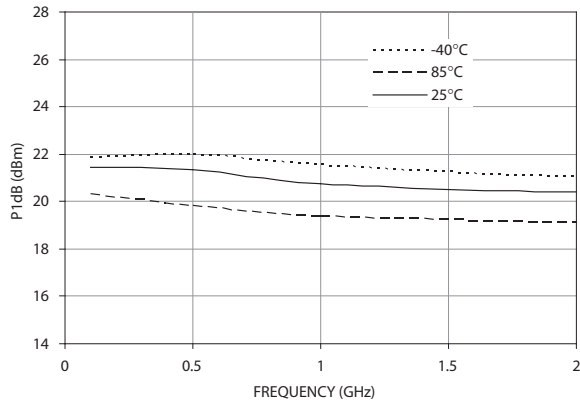

Figure 22. NF vs. Frequency (5V 5mA)

### Notes:

1.  $I_{ds}$  taken @ ambient temperature of 25°C may change with temperature variation.
2. Bias current ( $I_{ds}$ ) for the above charts are quiescent conditions. Actual level may increase or decrease depending on amount of RF drive.

**MGA-68563 Typical Performance, Vd = 5V, Ids (q) = 10mA at 50ohm Input and Output**



**Figure 23. P1dB vs. Frequency (5V,10mA), Ids=10mA during small signal, i.e. Pin=-20dBm)**

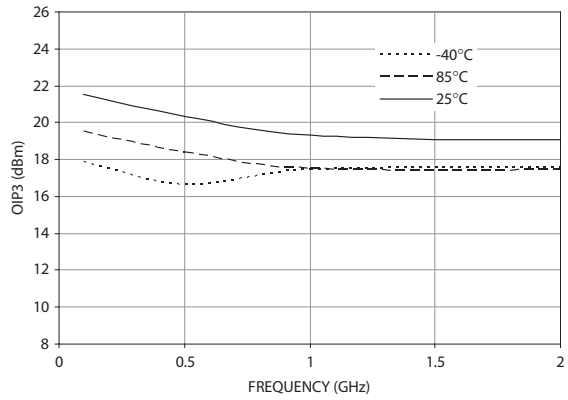

**Figure 24. OIP3 vs. Frequency (5V 10mA)**

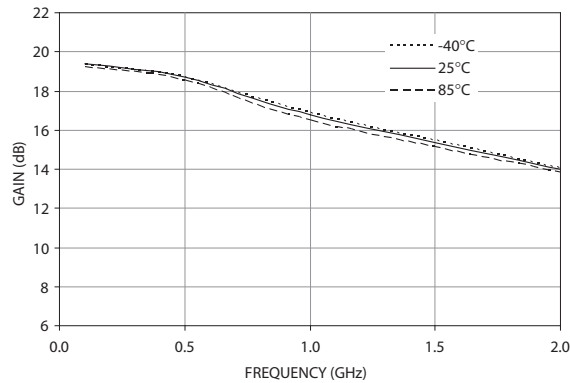

**Figure 25. Gain vs. Frequency (5V 10mA)**

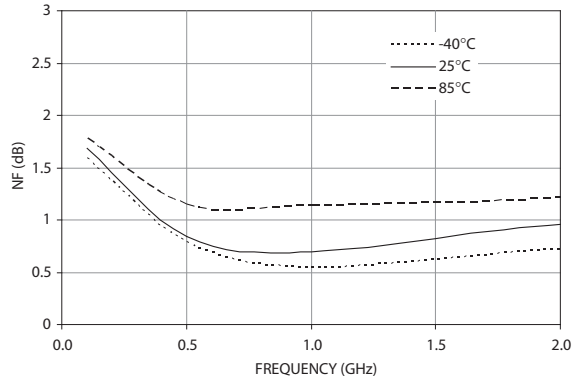

**Figure 26. NF vs. Frequency (5V 10mA)**

**Notes:**

1. Ids taken @ ambient temperature of 25°C may change with temperature variation.
2. Bias current (Ids) for the above charts are quiescent conditions. Actual level may increase or decrease depending on amount of RF drive.



**MGA-68563 Typical Performance, Vd = 5V, Ids (q) = 15mA at 50ohm Input and Output**

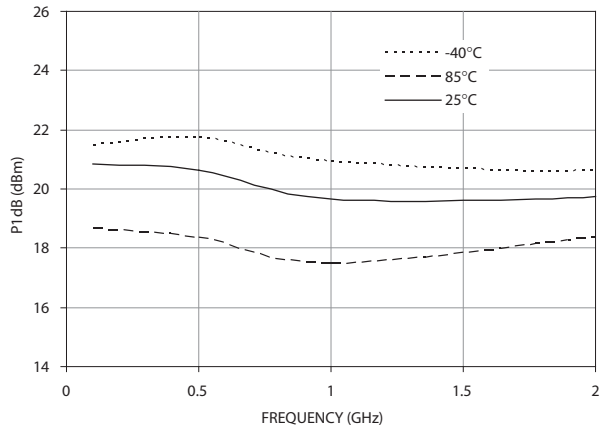

**Figure 27. P1dB vs. Frequency (5V,15mA), Ids=15mA during small signal, i.e. Pin=-20dBm)**

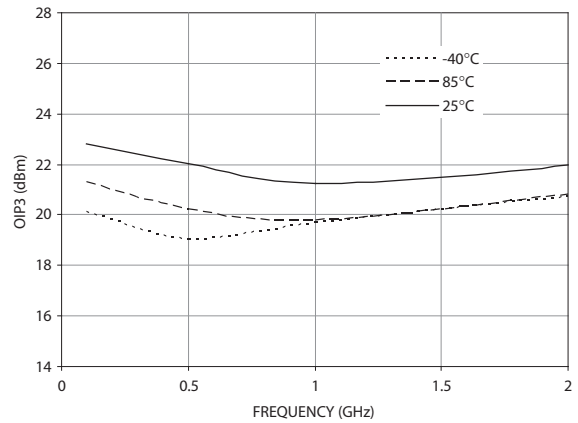

**Figure 28. OIP3 vs. Frequency (5V 15mA)**

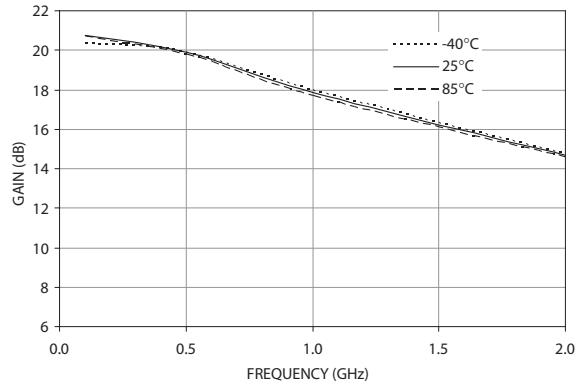

**Figure 29. Gain vs. Frequency (5V 15mA)**

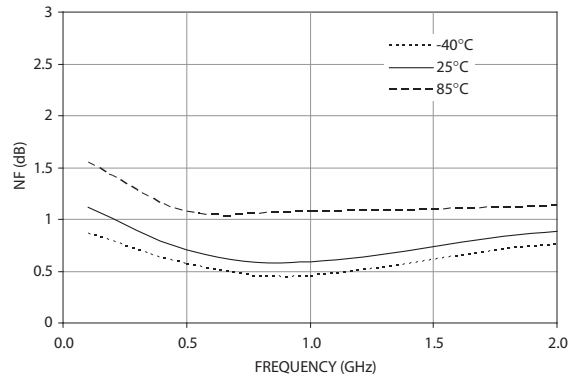
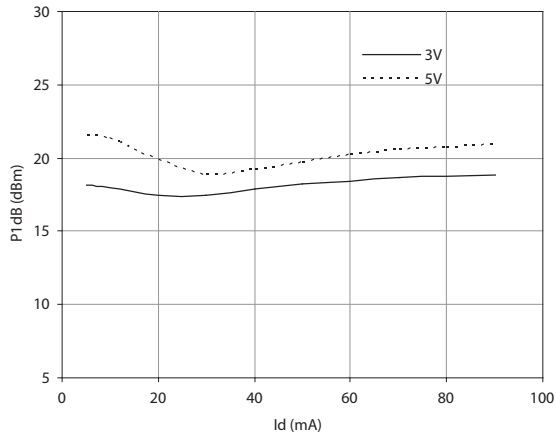

**Figure 30. NF vs. Frequency (5V 15mA)**

**Notes:**

1. Ids taken @ ambient temperature of 25°C may change with temperature variation.
2. Bias current (Ids) for the above charts are quiescent conditions. Actual level may increase or decrease depending on amount of RF drive.

**MGA-68563 Typical Performance, Freq = 0.5GHz, Tc = 25°C at 50ohm Input and Output**



**Figure 31. P1dB vs. Id (500MHz), Id at small signal, i.e. Pin=-20dBm)**

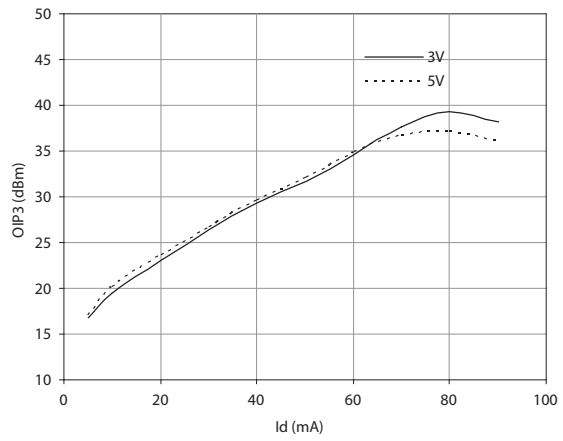

**Figure 32. OIP3 vs. Id (500 MHz)**

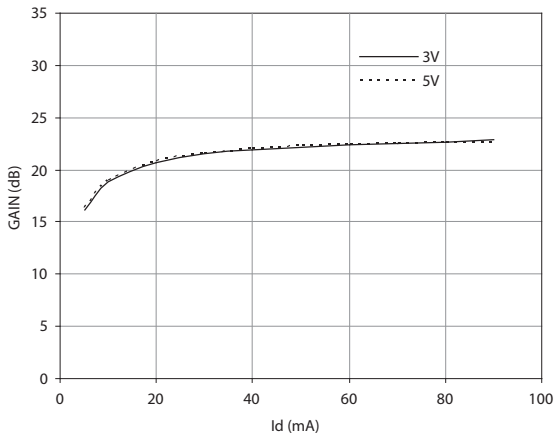

**Figure 33. Gain vs. Id (500 MHz)**

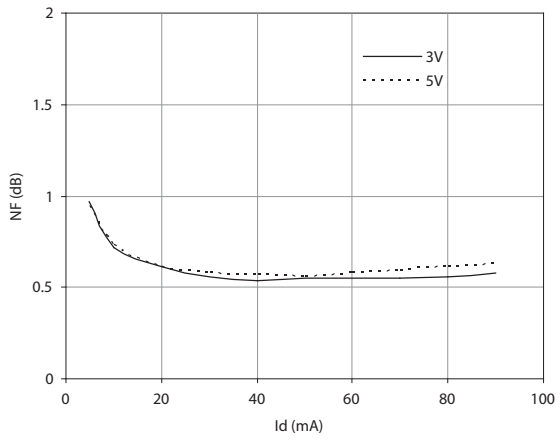
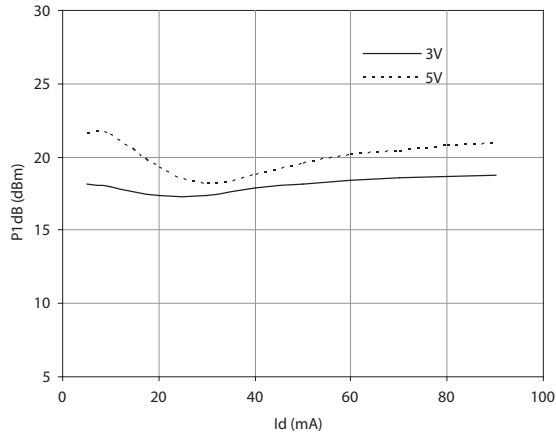

**Figure 34. NF vs. Id (500 MHz)**

**Notes:**

1. Bias current (Ids) for the above charts are quiescent conditions. Actual level may increase or decrease depending on amount of RF drive.

**MGA-68563 Typical Performance, Freq = 0.1GHz, Tc = 25°C at 50ohm Input and Output**



**Figure 35. P1dB vs. Id (100MHz), Id at small signal, i.e. Pin=-20dBm**

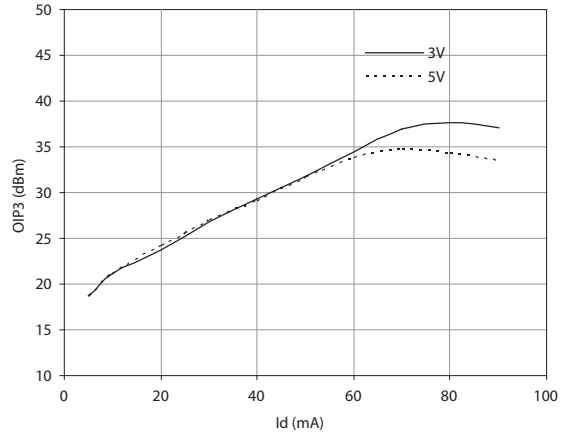

**Figure 36. OIP3 vs. Id (100 MHz)**

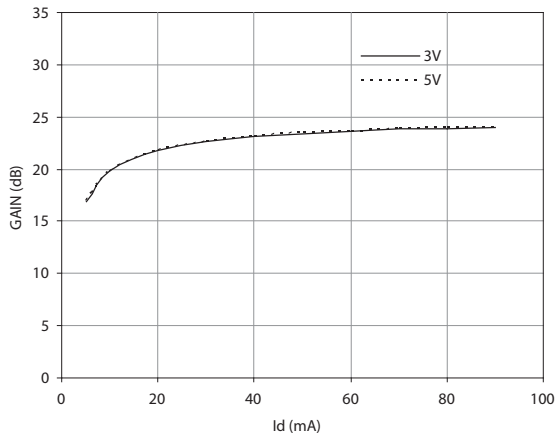

**Figure 37. Gain vs. Id (500 MHz)**

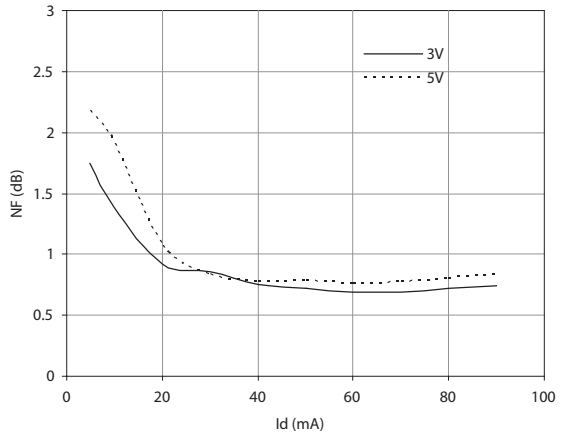
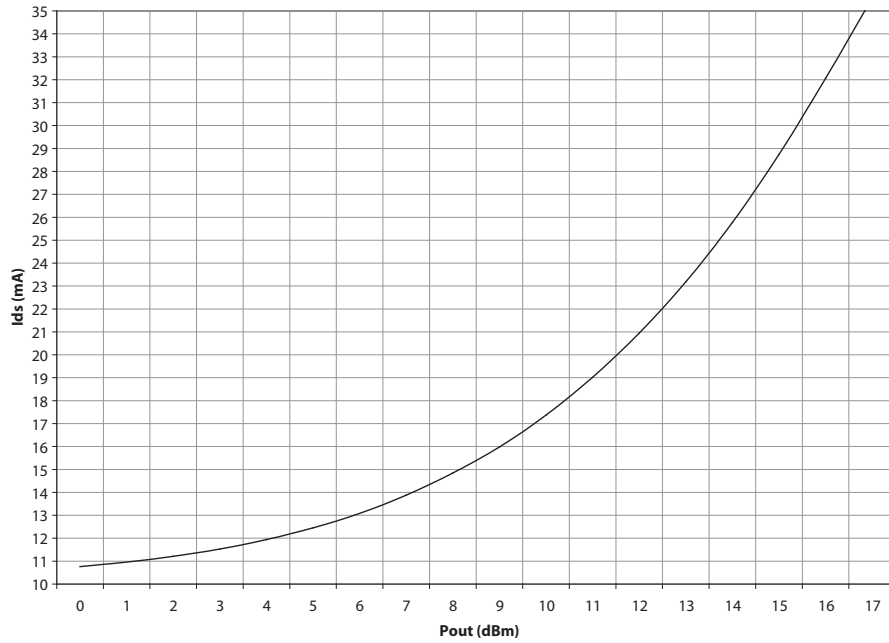

**Figure 38. NF vs. Id (500 MHz)**

**Notes:**

1. Bias current (Ids) for the above charts are quiescent conditions. Actual level may increase or decrease depending on amount of RF drive.

**MGA-68563 Typical Performance, Freq = 0.5GHz,  $I_{ds}(q) = 10mA$ ,  $T_c=25^\circ C$  at 50ohm Input and Output**



**Figure 39.  $I_{ds}$  vs.  $P_{out}$  ( $V_d = 3V$ )**

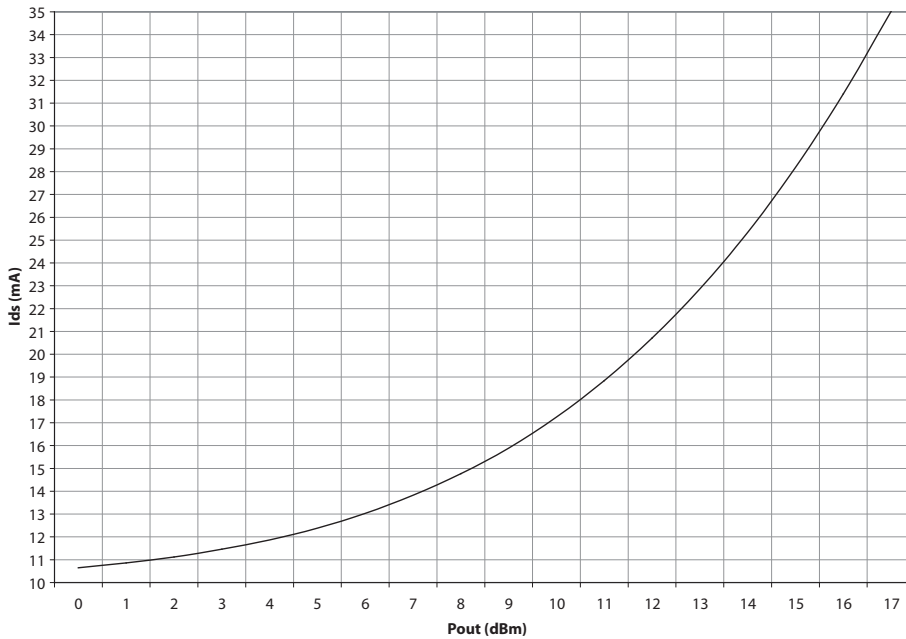

**Figure 40.  $I_{ds}$  vs.  $P_{out}$  ( $V_d = 5V$ )**

**Notes:**

1. Bias current ( $I_{ds} = 10mA$ ) for the above charts are quiescent conditions.

**MGA-68563 Typical Scattering Parameters, Tc = 25°C, Zo = 50ohm, Vd = 3V, Ids = 10mA**

Freq. GHz	S11		S21			S12		S22		K-factor
	Mag.	Ang.	dB	Mag.	Ang.	Mag.	Ang.	Mag.	Ang.	
0.3	0.42	-37.10	19.26	9.18	158.40	0.07	5.40	0.27	-32.20	1.01
0.5	0.36	-57.20	18.81	8.72	145.00	0.07	3.80	0.19	-47.50	1.04
0.7	0.38	-76.30	18.16	8.09	133.90	0.07	3.90	0.19	-63.10	1.02
0.9	0.40	-92.50	17.43	7.44	123.90	0.07	4.10	0.18	-75.80	1.03
1.0	0.41	-99.70	17.07	7.14	119.30	0.07	4.10	0.17	-81.80	1.03
1.1	0.42	-106.70	16.70	6.84	115.00	0.07	4.20	0.17	-86.30	1.04
1.3	0.44	-119.50	16.00	6.31	106.80	0.07	4.40	0.16	-95.10	1.04
1.5	0.45	-132.30	15.36	5.86	99.40	0.07	4.50	0.17	-98.30	1.06
1.7	0.47	-141.10	14.71	5.44	92.30	0.07	4.60	0.16	-107.70	1.08
1.9	0.48	-150.50	14.09	5.06	85.60	0.08	4.60	0.15	-115.30	1.11
2.0	0.49	-154.60	13.81	4.90	82.50	0.08	4.60	0.15	-116.20	1.11
2.5	0.51	-176.40	12.46	4.20	67.00	0.08	3.10	0.14	-131.90	1.16
3.0	0.50	160.80	11.13	3.60	53.80	0.09	2.00	0.15	-153.10	1.28
3.5	0.50	142.70	10.13	3.21	41.80	0.09	0.30	0.15	-176.10	1.35
4.0	0.51	126.90	9.74	3.07	25.20	0.11	-8.60	0.08	162.40	1.29

**Typical Noise Parameters at 25°C,**

Tc = 25°C, Zo = 50ohm, Vd = 3V, Ids = 10mA

Freq. GHz	Fmin dB	opt		Rn/50	NF@50
		Mag.	Ang.		dB
0.5	0.83	0.12	108.80	0.11	0.85
1.0	0.74	0.05	109.80	0.08	0.74
1.5	0.76	0.16	151.40	0.07	0.80
2.0	0.88	0.21	147.90	0.07	0.94
2.5	1.05	0.24	161.50	0.06	1.12
3.0	1.24	0.26	-173.10	0.09	1.31

**MGA-68563 Typical Scattering Parameters, Tc = 25°C, Zo = 50ohm, Vd = 3V, Ids = 5mA**

Freq.	S11		S21		S12		S22		K-factor	
	GHz	Mag.	Ang.	dB	Mag.	Ang.	Mag.	Ang.		Mag.
0.3	0.54	-28.80	16.61	6.77	160.50	0.07	6.50	0.43	-24.60	1.01
0.5	0.47	-44.40	16.31	6.54	147.20	0.08	4.20	0.35	-36.80	1.02
0.7	0.48	-60.80	15.77	6.15	136.80	0.08	4.00	0.33	-49.10	1.00
0.9	0.48	-75.60	15.15	5.72	127.10	0.08	3.60	0.31	-59.50	0.98
1.0	0.48	-82.30	14.85	5.53	122.60	0.08	3.10	0.30	-64.30	0.98
1.1	0.49	-89.20	14.53	5.33	118.40	0.08	2.80	0.29	-68.50	0.98
1.3	0.50	-102.00	13.93	4.97	110.30	0.09	2.00	0.28	-76.00	0.98
1.5	0.50	-114.50	13.37	4.66	102.90	0.09	1.10	0.28	-81.10	0.98
1.7	0.52	-124.30	12.82	4.38	95.80	0.09	0.10	0.25	-88.20	0.98
1.9	0.52	-134.20	12.27	4.11	88.90	0.09	-1.10	0.24	-94.80	1.01
2.0	0.53	-138.60	12.03	3.99	85.70	0.09	-1.50	0.23	-96.00	1.02
2.5	0.55	-162.10	10.86	3.49	69.70	0.10	-5.30	0.21	-110.40	1.07
3.0	0.53	173.50	9.61	3.02	55.60	0.10	-8.00	0.20	-127.80	1.23
3.5	0.51	153.90	8.67	2.71	42.90	0.10	-10.40	0.18	-146.80	1.35
4.0	0.53	137.40	8.38	2.62	26.70	0.11	-18.20	0.12	-153.40	1.32

**Typical Noise Parameters at 25°C,**

Tc = 25°C, Zo = 50ohm, Vd = 3V, Ids = 5mA

Freq.	Fmin	Γopt		Rn/50	NF@50Ω
		Mag.	Ang.		dB
GHz	dB				
0.5	1.21	0.15	97.70	0.14	1.25
1.0	1.01	0.12	62.80	0.11	1.03
1.5	1.04	0.18	114.20	0.11	1.10
2.0	1.07	0.24	123.90	0.09	1.17
2.5	1.20	0.28	141.00	0.08	1.33
3.0	1.41	0.29	162.20	0.10	1.50

**MGA-68563 Typical Scattering Parameters, Tc = 25°C, Zo = 50ohm, Vd = 3V, Ids = 15mA**

Freq.	S11		S21			S12		S22		K-factor
	GHz	Mag.	Ang.	dB	Mag.	Ang.	Mag.	Ang.	Mag.	
0.3	0.35	-43.60	20.54	10.64	157.30	0.06	5.00	0.18	-41.30	1.01
0.5	0.30	-67.40	19.99	9.99	143.70	0.06	3.90	0.11	-64.30	1.04
0.7	0.33	-87.40	19.27	9.20	132.40	0.06	4.40	0.12	-82.80	1.05
0.9	0.36	-103.80	18.49	8.41	122.20	0.06	5.30	0.12	-96.80	1.06
1.0	0.37	-110.90	18.10	8.03	117.60	0.06	5.60	0.12	-103.50	1.07
1.1	0.39	-117.60	17.70	7.68	113.20	0.06	6.10	0.12	-107.50	1.07
1.3	0.41	-129.90	16.95	7.04	105.00	0.06	7.10	0.12	-116.50	1.10
1.5	0.43	-142.10	16.26	6.50	97.60	0.06	7.90	0.12	-116.30	1.12
1.7	0.46	-150.20	15.57	6.00	90.70	0.07	8.60	0.12	-127.30	1.13
1.9	0.46	-159.10	14.91	5.56	84.00	0.07	9.10	0.12	-134.70	1.17
2.0	0.47	-162.90	14.61	5.38	81.00	0.07	9.30	0.11	-135.30	1.16
2.5	0.50	176.50	13.19	4.56	65.80	0.08	8.70	0.12	-149.80	1.20
3.0	0.50	154.70	11.82	3.90	53.00	0.08	7.90	0.14	-170.30	1.30
3.5	0.50	137.50	10.80	3.47	41.40	0.09	5.90	0.15	167.50	1.33
4.0	0.50	122.10	10.35	3.29	24.70	0.11	-3.90	0.09	137.50	1.27

**Typical Noise Parameters at 25°C,**

Tc = 25°C, Zo = 50ohm, Vd = 3V, Ids = 15mA

Freq.	Fmin	opt		Rn/50	NF@50
		Mag.	Ang.		dB
0.5	0.65	0.10	119.90	0.09	0.66
1.0	0.55	0.06	158.20	0.07	0.56
1.5	0.59	0.13	163.00	0.07	0.62
2.0	0.81	0.21	160.60	0.06	0.86
2.5	0.99	0.22	172.00	0.06	1.05
3.0	1.17	0.25	-163.70	0.09	1.22

## SOT-363/SC-70 (JEDEC DFP-N) Package Dimensions

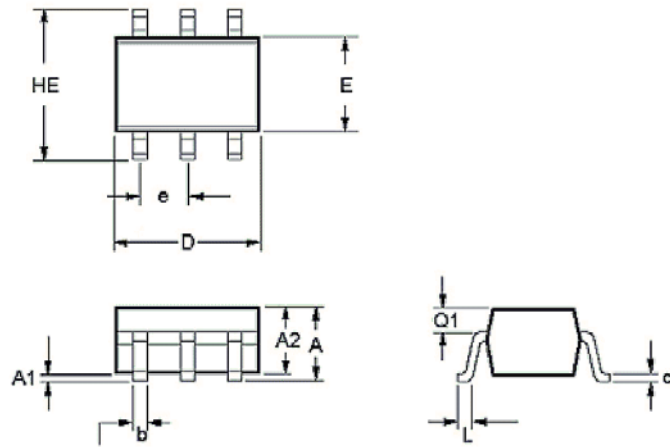

Symbol	Dimensions	
	Min (mm)	Max (mm)
E	1.15	1.35
D	1.80	2.25
HE	1.80	2.40
A	0.80	1.10
A2	0.80	1.00
A1	0.00	0.10
e	0.650 BCS	0.650 BCS
b	0.15	0.30
c	0.08	0.25
L	0.26	0.46

## Recommended PCB Pad Layout for Avago Technologies SC70 6L/SOT-363 Products

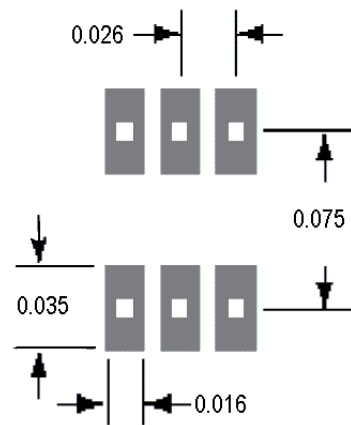

(dimensions in inches)



## Device Orientation

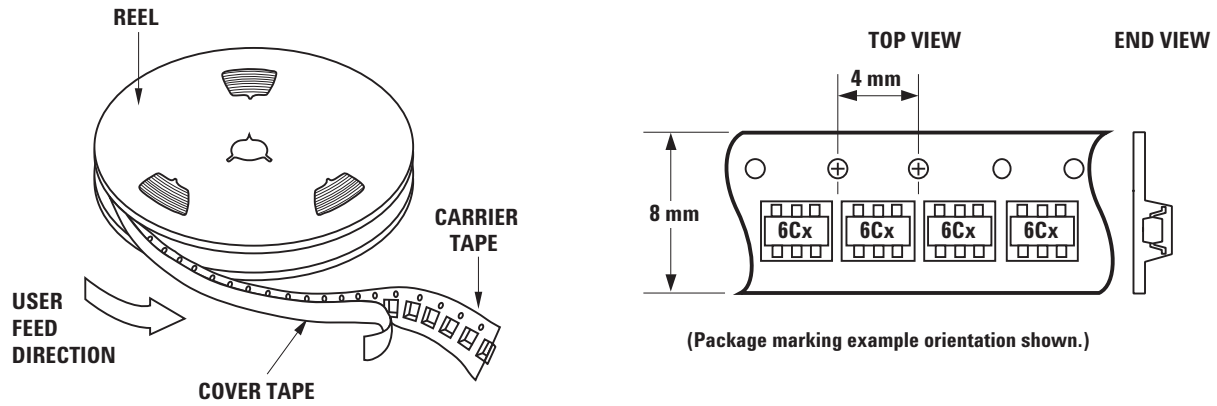

## Tape Dimensions

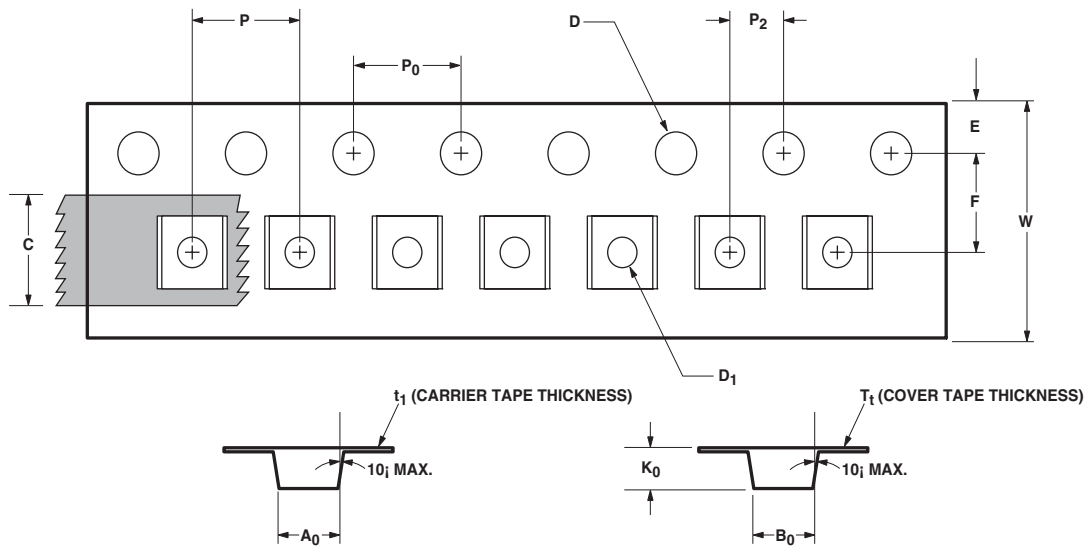

DESCRIPTION		SYMBOL	SIZE (mm)	SIZE (INCHES)
CAVITY	LENGTH	A <sub>0</sub>	2.40 ± 0.10	0.094 ± 0.004
	WIDTH	B <sub>0</sub>	2.40 ± 0.10	0.094 ± 0.004
	DEPTH	K <sub>0</sub>	1.20 ± 0.10	0.047 ± 0.004
	PITCH	P	4.00 ± 0.10	0.157 ± 0.004
	BOTTOM HOLE DIAMETER	D <sub>1</sub>	1.00 ± 0.25	0.039 ± 0.010
PERFORATION	DIAMETER	D	1.50 ± 0.10	0.061 ± 0.002
	PITCH	P <sub>0</sub>	4.00 ± 0.10	0.157 ± 0.004
	POSITION	E	1.75 ± 0.10	0.069 ± 0.004
CARRIER TAPE	WIDTH	W	8.00 ± 0.30 - 0.10	0.315 ± 0.012
	THICKNESS	t <sub>1</sub>	0.254 ± 0.02	0.010 ± 0.0005
COVER TAPE	WIDTH	C	5.40 ± 0.10	0.205 ± 0.004
	TAPE THICKNESS	T <sub>t</sub>	0.062 ± 0.001	0.0025 ± 0.00004
DISTANCE	CAVITY TO PERFORATION (WIDTH DIRECTION)	F	3.50 ± 0.05	0.138 ± 0.002
	CAVITY TO PERFORATION (LENGTH DIRECTION)	P <sub>2</sub>	2.00 ± 0.05	0.079 ± 0.002

### Ordering Information

Part No.	No. of Devices	Container
MGA-68563-TR1G	3000	7" Reel
MGA-68563-TR2G	10000	13" Reel
MGA-68563-BLKG	100	antistatic bag

For product information and a complete list of distributors, please go to our web site: [www.avagotech.com](http://www.avagotech.com)

Avago, Avago Technologies, and the A logo are trademarks of Avago Technologies in the United States and other countries.  
Data subject to change. Copyright © 2005-2011 Avago Technologies. All rights reserved. Obsoletes AV01-0474EN  
AV02-0654EN - April 4, 2011

