

ADA-4643

Silicon Bipolar Darlington Amplifier



Data Sheet

Description

Avago Technologies' ADA-4643 is an economical, easy-to-use, general purpose silicon bipolar RFIC gain block amplifiers housed in a 4-lead SC-70 (SOT-343) surface mount plastic package which requires only half the board space of a SOT-143 package.

The Darlington feedback structure provides inherent broad bandwidth performance, resulting in useful operating frequency up to 2.5 GHz. This is an ideal device for small-signal gain cascades or IF amplification.

ADA-4643 is fabricated using Avago's HP25 silicon bipolar process, which employs a double-diffused single polysilicon process with self-aligned submicron emitter geometry. The process is capable of simultaneous high f_T and high NPN breakdown (25 GHz f_T at 6V BVCEO). The process utilizes industry standard device oxide isolation technologies and submicron aluminum multilayer interconnect to achieve superior performance, high uniformity, and proven reliability.

Surface Mount Package SOT-343

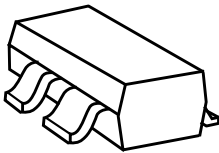

Pin Connections and Package Marking

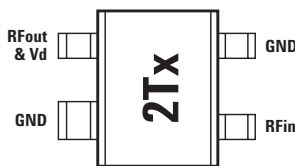

Note:

Top View. Package marking provides orientation and identification.

"2T" = Device Code

"x" = Date code character identifies month of manufacture.

Features

- Small Signal gain amplifier
- Operating frequency DC – 2.5 GHz
- Unconditionally stable
- 50 Ohms input & output
- Flat, Broadband Frequency Response up to 1 GHz
- Operating Current: 20 to 60 mA
- Industry standard SOT-343 package
- Lead-free option available

Specifications

900 MHz, 3.5V, 35 mA (typ.)

- 17 dB associated gain
- 13.4 dBm P_{1dB}
- 28.3 dBm OIP_3
- 4 dB noise figure
- VSWR < 2.2 throughput operating frequency
- Single supply, typical $I_d = 35$ mA

Applications

- Cellular/PCS/WLL base stations
- Wireless data/WLAN
- Fiber-optic systems
- ISM

Typical Biasing Configuration

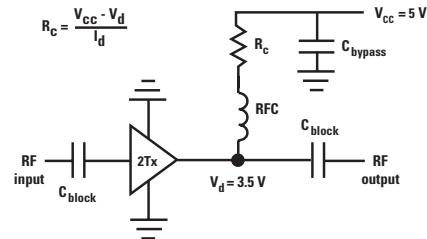

Attention:

Observe precautions for handling electrostatic sensitive devices.

ESD Machine Model (Class A)

ESD Human Body Model (Class 1B)

Refer to Avago Application Note A004R: Electrostatic Discharge Damage and Control.

ADA-4643 Absolute Maximum Ratings^[1]

Symbol	Parameter	Units	Absolute Maximum
I_d	Device Current	mA	70
P_{diss}	Total Power Dissipation ^[2]	mW	270
$P_{in\ max.}$	RF Input Power	dBm	18
T_j	Channel Temperature	°C	150
T_{STG}	Storage Temperature	°C	-65 to 150
θ_{jc}	Thermal Resistance ^[3]	°C/W	152

Notes:

1. Operation of this device above any one of these parameters may cause permanent damage.
2. Ground lead temperature is 25°C. Derate 6.6 mW/°C for TL >109°C.
3. Junction-to-case thermal resistance measured using 150°C Liquid Crystal Measurement method.

ADA-4643 Electrical Specifications

$T_A = 25^\circ\text{C}$, $Z_0 = 50\Omega$, $P_{in} = -25\ \text{dBm}$, $I_d = 35\ \text{mA}$ (unless specified otherwise)

Symbol	Parameter and Test Condition: $I_d = 35\ \text{mA}$, $Z_0 = 50\Omega$	Frequency	Units	Min.	Typ.	Max.	Std. Dev.
V_d	Device Voltage $I_d = 35\ \text{mA}$		V	3.2	3.5	3.9	
G_p	Power Gain ($ S_{21} ^2$)	100 MHz 900 MHz ^[1,2]	dB	15.5	17.5 17.0	18.5	
ΔG_p	Gain Flatness	100 to 900 MHz 0.1 to 2 GHz	dB		0.5 1.8		
F_{3dB}	3 dB Bandwidth		GHz		3.2		
$VSWR_{in}$	Input Voltage Standing Wave Ratio	0.1 to 6 GHz			2.0:1		
$VSWR_{out}$	Output Voltage Standing Wave Ratio	0.1 to 6 GHz			1.6:1		
NF	50Ω Noise Figure	100 MHz 900 MHz ^[1,2]	dB		3.9 4.0		0.07 0.1
P_{1dB}	Output Power at 1dB Gain Compression	100 MHz 900 MHz ^[1,2]	dBm		14.7 13.4		
OIP_3	Output 3 rd Order Intercept Point	100 MHz ^[3] 900 MHz ^[1,2,3]	dBm		29.0 28.3		
DV/dT	Device Voltage Temperature Coefficient		mV/°C		-5.3		

Notes:

1. Typical value determined from a sample size of 500 parts from 3 wafers.
2. Measurement obtained using production test board described in the block diagram below.
3. I) 900 MHz OIP_3 test condition: $F_1 = 900\ \text{MHz}$, $F_2 = 905\ \text{MHz}$ and $P_{in} = -25\ \text{dBm}$ per tone.
II) 100 MHz OIP_3 test condition: $F_1 = 100\ \text{MHz}$, $F_2 = 105\ \text{MHz}$ and $P_{in} = -25\ \text{dBm}$ per tone.

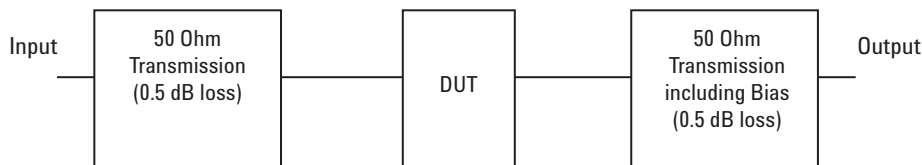

Block diagram of 900 MHz production test board used for V_d , Gain, P_{1dB} , OIP_3 , and NF measurements. Circuit losses have been de-embedded from actual measurements.

Product Consistency Distribution Charts at 900 MHz, $I_d = 35$ mA

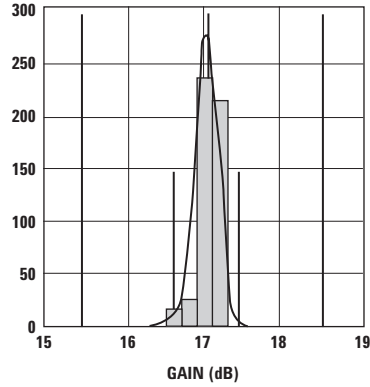

Figure 1. Gain distribution @ 35 mA.
LSL = 15.5, Nominal = 17, USL = 18.5

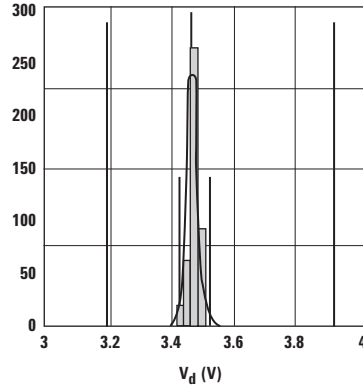

Figure 2. V_d distribution @ 35 mA.
LSL = 3.2, Nominal = 3.5, USL = 3.9

Notes:

1. Statistics distribution determined from a sample size of 500 parts taken from 3 different wafers.
2. Future wafers allocated to this product may have typical values anywhere between the minimum and maximum specification limits.

ADA-4643 Typical Performance Curves (at 25°C, unless specified otherwise)

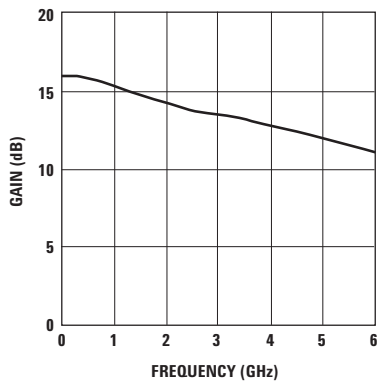

Figure 3. Gain vs. Frequency at $I_d = 35$ mA.

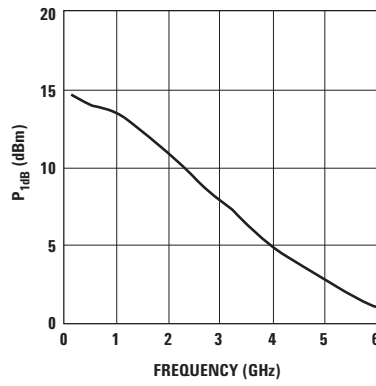

Figure 4. P_{1dB} vs. Frequency at $I_d = 35$ mA.

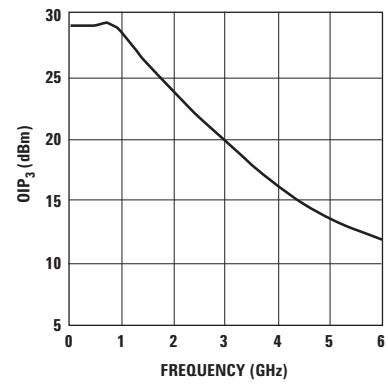

Figure 5. OIP_3 vs. Frequency at $I_d = 35$ mA.

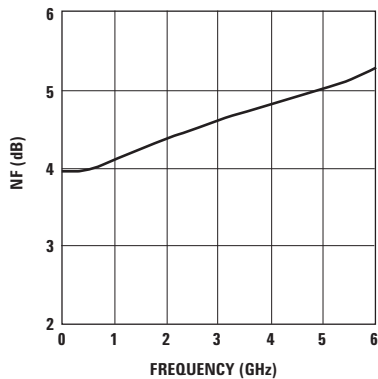

Figure 6. NF vs. Frequency at $I_d = 35$ mA.

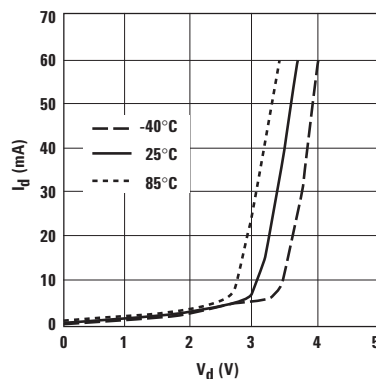

Figure 7. I_d vs. V_d and Temperature.

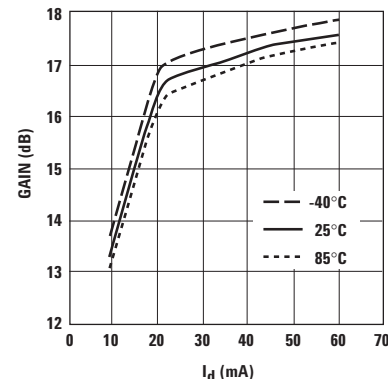

Figure 8. Gain vs. I_d and Temperature at 900 MHz.

ADA-4643 Typical Performance Curves (at 25°C, unless specified otherwise), continued

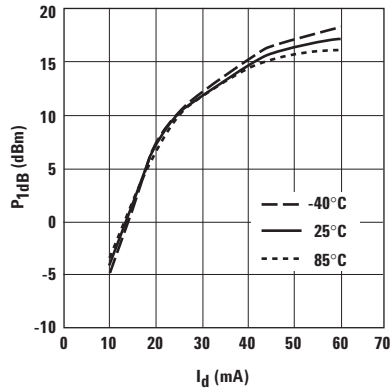

Figure 9. P_{1dB} vs. I_d and Temperature at 900 MHz.

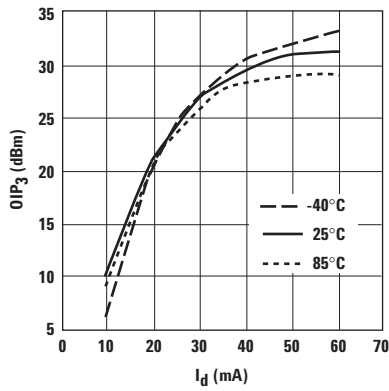

Figure 10. OIP₃ vs. I_d and Temperature at 900 MHz.

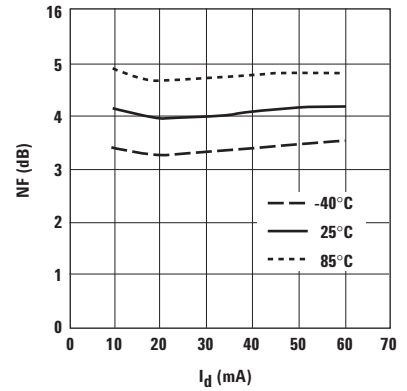

Figure 11. NF vs. I_d and Temperature at 900 MHz.

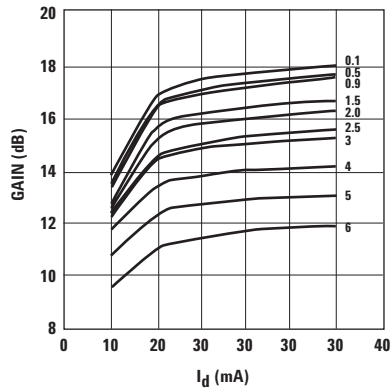

Figure 12. Gain vs. I_d and Frequency (GHz).

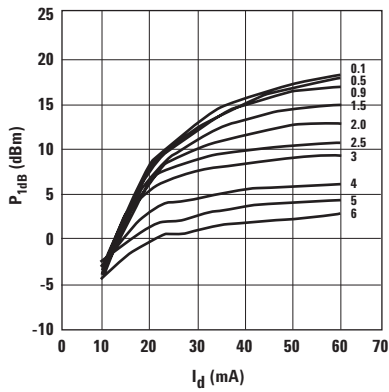

Figure 13. P_{1dB} vs. I_d and Frequency (GHz).

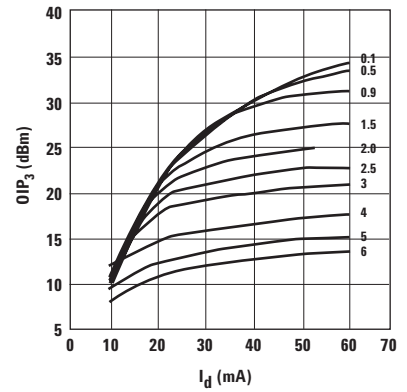

Figure 14. OIP₃ vs. I_d and Frequency (GHz).

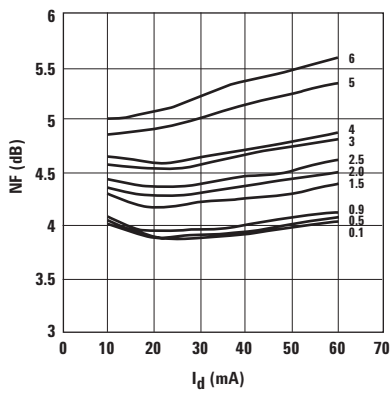

Figure 15. NF vs. I_d and Frequency (GHz).

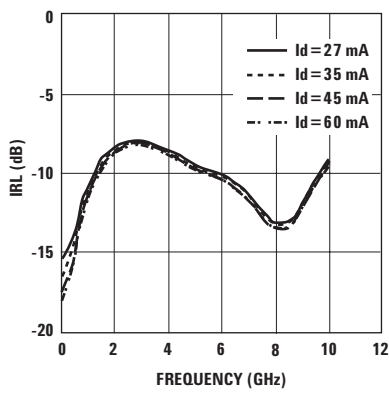

Figure 16. Input Return Loss vs. I_d and Frequency (GHz).

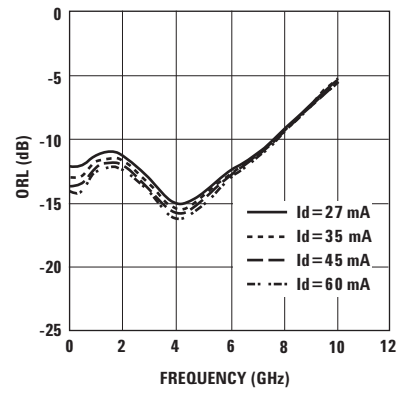

Figure 17. Output Return Loss vs. I_d and Frequency (GHz).

ADA-4643 Typical Scattering Parameters, $T_A = 25^\circ\text{C}$, $I_d = 27\text{ mA}$

Freq. GHz	S ₁₁			S ₂₁			S ₁₂		S ₂₂		K
	Mag.	Ang.	dB	Mag.	Ang.	Mag.	Ang.	Mag.	Ang.		
0.1	0.172	1.1	17.2	7.246	175.9	0.093	-0.8	0.245	-4.1	1.1	
0.5	0.202	10	17.04	7.113	160.2	0.091	-4.5	0.245	-12.6	1.1	
0.9	0.277	12.3	16.67	6.814	144.7	0.088	-7.4	0.269	-20.4	1.1	
1.0	0.286	9.9	16.56	6.726	141.1	0.087	-7.9	0.274	-23.1	1.1	
1.5	0.349	-2.8	15.98	6.292	124.2	0.083	-9.3	0.28	-37.6	1.1	
1.9	0.375	-11.3	15.54	5.984	111.4	0.080	-9.5	0.273	-48.9	1.2	
2.0	0.382	-13.8	15.44	5.918	108.3	0.08	-9.5	0.271	-51.7	1.2	
2.5	0.397	-24.2	14.93	5.581	93.2	0.078	-8.9	0.249	-65.8	1.2	
3.0	0.402	-34.7	14.47	5.29	78.6	0.078	-7.8	0.22	-81.7	1.3	
3.5	0.394	-46	14.02	5.021	64.2	0.079	-6.6	0.192	-100.9	1.3	
4.0	0.378	-58.7	13.58	4.775	50	0.082	-5.4	0.176	-123.8	1.3	
4.5	0.361	-73.1	13.16	4.55	35.9	0.087	-4.6	0.179	-148.6	1.3	
5.0	0.340	-89.3	12.64	4.284	21.9	0.094	-4.9	0.191	-169.9	1.3	
5.5	0.328	-107.1	12.15	4.05	8.3	0.102	-5.9	0.212	173.3	1.2	
6.0	0.318	-124.8	11.6	3.803	-5.4	0.112	-8.3	0.233	158.2	1.2	
6.5	0.299	-141.1	11.09	3.584	-18.6	0.124	-11.5	0.25	141.6	1.1	
7.0	0.274	-159.7	10.56	3.371	-32	0.138	-16.5	0.27	123	1.1	
7.5	0.243	177.3	9.96	3.149	-45.6	0.150	-22.8	0.3	103.6	1.1	
8.0	0.222	148.7	9.29	2.914	-59.1	0.161	-30	0.337	84.8	1.1	
8.5	0.226	119.9	8.41	2.632	-71.8	0.168	-36.7	0.381	70.1	1.1	
9.0	0.26	95.4	7.62	2.406	-83.7	0.177	-43	0.429	58.4	1.1	
9.5	0.305	75.2	6.67	2.155	-96.1	0.187	-49.9	0.481	48.4	1.1	
10.0	0.356	60.1	5.82	1.954	-107.1	0.195	-57.3	0.529	39.7	1	

Notes:

1. S-parameters are measured on a microstrip line made on 0.025 inch thick alumina carrier. The input reference plane is at the end of the input lead. The output reference plane is at the end of the output lead.

ADA-4643 Typical Scattering Parameters, $T_A = 25^\circ\text{C}$, $I_d = 35\text{ mA}$

Freq. GHz	S ₁₁			S ₂₁			S ₁₂		S ₂₂		K
	Mag.	Ang.	dB	Mag.	Ang.	Mag.	Ang.	Mag.	Ang.		
0.1	0.151	1.6	17.51	7.504	175.9	0.091	-0.8	0.223	-4.1	1.1	
0.5	0.185	13.1	17.35	7.367	160.1	0.09	-4.2	0.224	-11.7	1.1	
0.9	0.265	14.9	16.98	7.06	144.6	0.087	-7	0.251	-19	1.1	
1.0	0.272	12.4	16.86	6.97	140.9	0.086	-7.5	0.256	-21.7	1.1	
1.5	0.340	-0.7	16.27	6.511	123.9	0.082	-8.8	0.264	-36.2	1.1	
1.9	0.367	-9.5	15.82	6.178	111	0.080	-9.1	0.259	-47.6	1.2	
2.0	0.373	-12.1	15.72	6.107	108	0.079	-9.1	0.256	-50.3	1.2	
2.5	0.39	-22.7	15.19	5.745	92.8	0.078	-8.5	0.236	-64.4	1.2	
3.0	0.395	-33	14.71	5.436	78.3	0.077	-7.3	0.209	-80.4	1.3	
3.5	0.387	-44.3	14.23	5.149	63.9	0.079	-6	0.181	-99.9	1.3	
4.0	0.370	-57.4	13.79	4.89	49.9	0.082	-4.8	0.166	-123.4	1.3	
4.5	0.353	-71.6	13.36	4.657	35.9	0.087	-3.9	0.17	-148.9	1.3	
5.0	0.332	-87.7	12.84	4.383	21.9	0.093	-4.2	0.185	-170.6	1.2	
5.5	0.319	-106	12.34	4.141	8.3	0.102	-5.1	0.207	172.5	1.2	
6.0	0.310	-123.6	11.8	3.889	-5.4	0.112	-7.5	0.23	157.5	1.2	
6.5	0.293	-140.2	11.28	3.666	-18.6	0.124	-10.8	0.248	140.9	1.1	
7.0	0.266	-158.8	10.75	3.449	-32	0.138	-15.8	0.27	122.3	1.1	
7.5	0.238	177.8	10.15	3.219	-45.5	0.151	-22.2	0.301	103	1.1	
8.0	0.217	148.5	9.48	2.979	-59	0.161	-29.3	0.34	84.3	1.1	
8.5	0.222	119.5	8.62	2.697	-71.7	0.169	-36.1	0.385	69.6	1.1	
9.0	0.256	95	7.81	2.458	-83.4	0.178	-42.5	0.434	57.9	1.1	
9.5	0.300	74.9	6.88	2.208	-95.8	0.188	-49.5	0.486	47.9	1	
10.0	0.357	59.1	6.01	1.996	-107.2	0.196	-56.9	0.534	39.2	1	

Notes:

1. S-parameters are measured on a microstrip line made on 0.025 inch thick alumina carrier. The input reference plane is at the end of the input lead. The output reference plane is at the end of the output lead.

ADA-4643 Typical Scattering Parameters, $T_A = 25^\circ\text{C}$, $I_d = 45\text{ mA}$

Freq. GHz	S ₁₁			S ₂₁			S ₁₂		S ₂₂		K
	Mag.	Ang.	dB	Mag.	Ang.	Mag.	Ang.	Mag.	Ang.		
0.1	0.137	2.4	17.72	7.691	175.9	0.09	-0.7	0.207	-4	1.1	
0.5	0.174	15.3	17.56	7.547	160	0.089	-4	0.209	-10.9	1.1	
0.9	0.257	17.4	17.19	7.234	144.5	0.086	-6.8	0.238	-17.6	1.1	
1.0	0.267	14.7	17.08	7.144	140.8	0.085	-7.2	0.243	-20.3	1.1	
1.5	0.334	0.7	16.47	6.664	123.7	0.081	-8.5	0.253	-34.8	1.1	
1.9	0.36	-8.4	16.01	6.317	110.7	0.079	-8.7	0.249	-46.1	1.1	
2.0	0.367	-10.9	15.91	6.241	107.7	0.079	-8.7	0.247	-48.9	1.2	
2.5	0.386	-21.6	15.36	5.862	92.5	0.077	-8.1	0.227	-62.9	1.2	
3.0	0.39	-32.1	14.86	5.534	78	0.077	-7	0.201	-78.9	1.2	
3.5	0.382	-43.4	14.38	5.237	63.6	0.078	-5.7	0.174	-98.4	1.3	
4.0	0.365	-56.4	13.93	4.971	49.7	0.081	-4.5	0.159	-122.3	1.3	
4.5	0.348	-70.8	13.5	4.732	35.7	0.086	-3.6	0.164	-148.3	1.3	
5.0	0.327	-86.8	12.97	4.45	21.7	0.093	-3.9	0.179	-170.4	1.2	
5.5	0.314	-105.1	12.48	4.205	8.2	0.101	-4.8	0.202	172.6	1.2	
6.0	0.304	-122.8	11.93	3.947	-5.5	0.112	-7.1	0.226	157.6	1.2	
6.5	0.287	-139.6	11.41	3.721	-18.7	0.124	-10.4	0.245	140.9	1.1	
7.0	0.26	-159.1	10.88	3.498	-32	0.138	-15.4	0.268	122.3	1.1	
7.5	0.232	177.6	10.28	3.264	-45.6	0.151	-21.8	0.3	102.9	1.1	
8.0	0.213	147.8	9.6	3.02	-59.1	0.161	-28.9	0.339	84.2	1.1	
8.5	0.218	120.2	8.7	2.724	-71.7	0.169	-35.8	0.385	69.5	1.1	
9.0	0.26	94.2	7.95	2.498	-83.7	0.179	-42.1	0.434	57.9	1.1	
9.5	0.303	74	6.98	2.233	-96.2	0.189	-49.2	0.487	47.9	1	
10.0	0.352	59.4	6.14	2.027	-107.1	0.196	-56.6	0.535	39.1	1	

Notes:

1. S-parameters are measured on a microstrip line made on 0.025 inch thick alumina carrier. The input reference plane is at the end of the input lead. The output reference plane is at the end of the output lead.

ADA-4643 Typical Scattering Parameters, $T_A = 25^\circ\text{C}$, $I_d = 60\text{ mA}$

Freq. GHz	S_{11}		dB	S_{21}		S_{12}		S_{22}		K
	Mag.	Ang.		Mag.	Ang.	Mag.	Ang.	Mag.	Ang.	
0.1	0.126	2.4	17.88	7.834	175.9	0.089	-0.7	0.194	-3.8	1.1
0.5	0.165	18.1	17.73	7.696	159.9	0.088	-3.8	0.196	-9.9	1.1
0.9	0.252	19.6	17.36	7.377	144.3	0.085	-6.4	0.227	-16.1	1.1
1.0	0.261	16.4	17.24	7.28	140.6	0.085	-6.9	0.233	-18.8	1.1
1.5	0.33	2	16.63	6.787	123.3	0.081	-8.2	0.244	-33.2	1.1
1.9	0.359	-7.4	16.16	6.424	110.3	0.079	-8.4	0.241	-44.4	1.1
2.0	0.365	-9.8	16.05	6.343	107.2	0.078	-8.4	0.239	-47.2	1.1
2.5	0.386	-21	15.49	5.948	91.9	0.077	-7.8	0.221	-61	1.2
3.0	0.387	-31.5	14.98	5.61	77.4	0.077	-6.7	0.195	-76.8	1.2
3.5	0.381	-43	14.49	5.301	63.1	0.078	-5.5	0.168	-96.2	1.3
4.0	0.363	-56	14.02	5.025	49	0.081	-4.3	0.153	-120.3	1.3
4.5	0.344	-70.7	13.58	4.777	35	0.086	-3.5	0.157	-146.9	1.3
5.0	0.323	-87.3	13.04	4.488	21	0.093	-3.7	0.172	-169.4	1.2
5.5	0.31	-105.8	12.54	4.235	7.5	0.101	-4.6	0.195	173.4	1.2
6.0	0.301	-123.6	11.98	3.971	-6.2	0.111	-6.9	0.22	158.2	1.2
6.5	0.281	-140.6	11.44	3.735	-19.4	0.124	-10.2	0.239	141.4	1.1
7.0	0.257	-159.9	10.9	3.507	-32.7	0.138	-15.2	0.262	122.5	1.1
7.5	0.228	176.3	10.29	3.271	-46.3	0.151	-21.5	0.294	103	1.1
8.0	0.212	145.6	9.61	3.022	-59.8	0.161	-28.6	0.333	84.3	1.1
8.5	0.218	117.8	8.72	2.728	-72.4	0.169	-35.6	0.38	69.5	1.1
9.0	0.257	92.7	7.94	2.494	-84.1	0.178	-41.8	0.429	57.9	1.1
9.5	0.302	72.9	6.98	2.234	-96.4	0.189	-48.9	0.482	47.9	1
10.0	0.359	57.7	6.11	2.02	-107.7	0.196	-56.4	0.531	39.2	1

Notes:

1. S-parameters are measured on a microstrip line made on 0.025 inch thick alumina carrier. The input reference plane is at the end of the input lead. The output reference plane is at the end of the output lead.

Ordering Information

Part Number	No. of Devices	Container
ADA-4643-TR1	3000	7" Reel
ADA-4643-TR2	10000	13" Reel
ADA-4643-BLK	100	antistatic bag
ADA-4643-TR1G	3000	7" Reel
ADA-4643-TR2G	10000	13" Reel
ADA-4643-BLKG	100	antistatic bag

Note: For lead-free option, the part number will have the character "G" at the end.

Package Dimensions Outline 43 SOT-343 (SC70 4-lead)

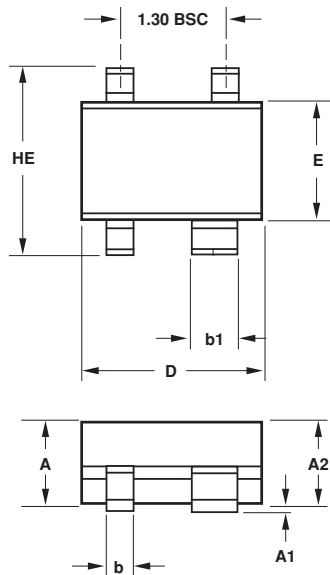

SYMBOL	DIMENSIONS (mm)	
	MIN.	MAX.
E	1.15	1.35
D	1.85	2.25
HE	1.80	2.40
A	0.80	1.10
A2	0.80	1.00
A1	0.00	0.10
b	0.25	0.40
b1	0.55	0.70
c	0.10	0.20
L	0.10	0.46

NOTES:

1. All dimensions are in mm.
2. Dimensions are inclusive of plating.
3. Dimensions are exclusive of mold flash & metal burr.
4. All specifications comply to EIAJ SC70.
5. Die is facing up for mold and facing down for trim/form, ie: reverse trim/form.
6. Package surface to be mirror finish.

Recommended PCB Pad Layout for Avago's SC70 4L/SOT-343 Products

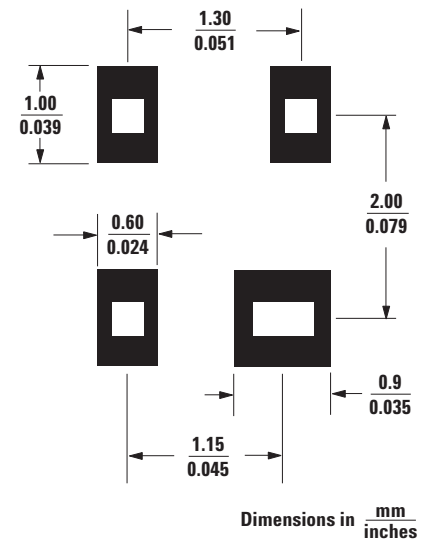

Device Orientation

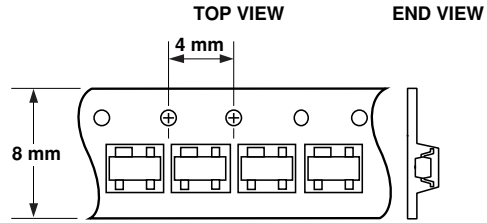
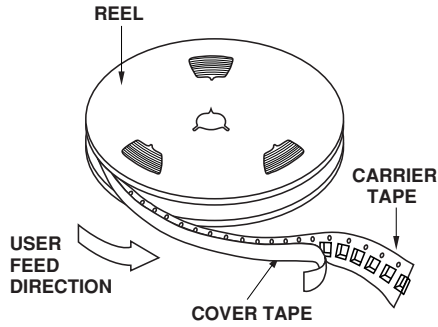

Tape Dimensions For Outline 4T

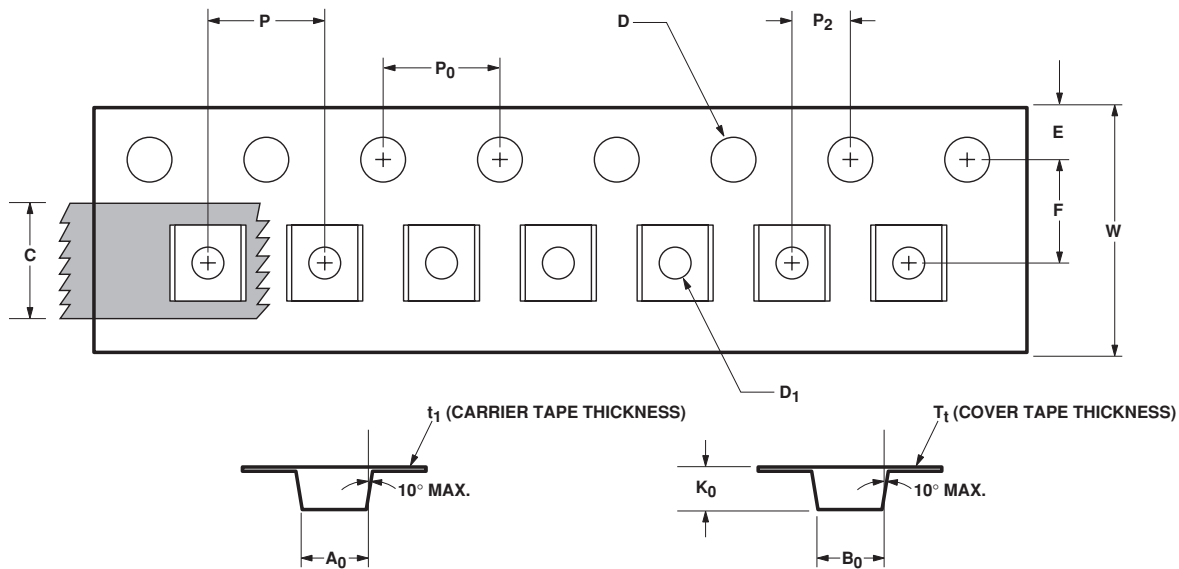

	DESCRIPTION	SYMBOL	SIZE (mm)	SIZE (INCHES)
CAVITY	LENGTH	A_0	2.40 ± 0.10	0.094 ± 0.004
	WIDTH	B_0	2.40 ± 0.10	0.094 ± 0.004
	DEPTH	K_0	1.20 ± 0.10	0.047 ± 0.004
	PITCH	P	4.00 ± 0.10	0.157 ± 0.004
	BOTTOM HOLE DIAMETER	D_1	1.00 ± 0.25	0.039 ± 0.010
PERFORATION	DIAMETER	D	1.50 ± 0.10	0.061 ± 0.002
	PITCH	P_0	4.00 ± 0.10	0.157 ± 0.004
	POSITION	E	1.75 ± 0.10	0.069 ± 0.004
CARRIER TAPE	WIDTH	W	$8.00 \pm 0.30 - 0.10$	0.315 ± 0.012
	THICKNESS	t_1	0.254 ± 0.02	0.0100 ± 0.0008
COVER TAPE	WIDTH	C	5.40 ± 0.10	0.205 ± 0.004
	TAPE THICKNESS	T_t	0.062 ± 0.001	0.0025 ± 0.0004
DISTANCE	CAVITY TO PERFORATION (WIDTH DIRECTION)	F	3.50 ± 0.05	0.138 ± 0.002
	CAVITY TO PERFORATION (LENGTH DIRECTION)	P_2	2.00 ± 0.05	0.079 ± 0.002

For product information and a complete list of distributors, please go to our web site:
www.avagotech.com

Avago, Avago Technologies, and the A logo are trademarks of Avago Technologies, Limited in the United States and other countries.

Data subject to change. Copyright © 2006 Avago Technologies, Limited. All rights reserved.
 Obsoletes 5989-1975EN
 5989-3753EN May 22, 2006

AVAGO
 TECHNOLOGIES