

TOSHIBA Bipolar Linear Integrated Circuit Silicon Monolithic
TA31275FN, TA31275FNG

AM/FM RF/IF Detector IC for Low Power Wireless System

The TA31275FN is an RF/IF detector IC for AM/FM radio.
 The IC incorporates an RF amp, 2-level comparator, and local $\times 8$ circuit

Features

- RF frequency: 240 to 450 MHz (multiplication is used)
 100 to 450 MHz (multiplication is not used)
- IF frequency: 10.7 MHz
- Operating voltage range: 2.4 to 5.5 V
- Current dissipation: 5.8 mA (FM)/5.4 mA (AM)
 (except current at oscillator circuit)
- Current dissipation at BS: 0 μ A (typ.)
- Small package: 24-pin SSOP (0.65 mm pitch)

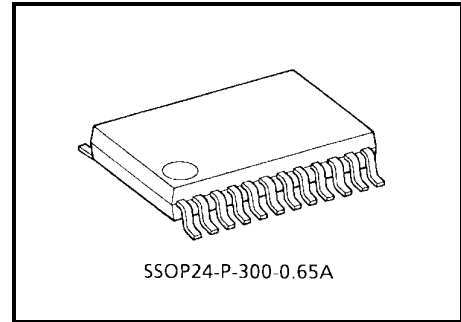

Weight: 0.09 g (typ.)

Block Diagram

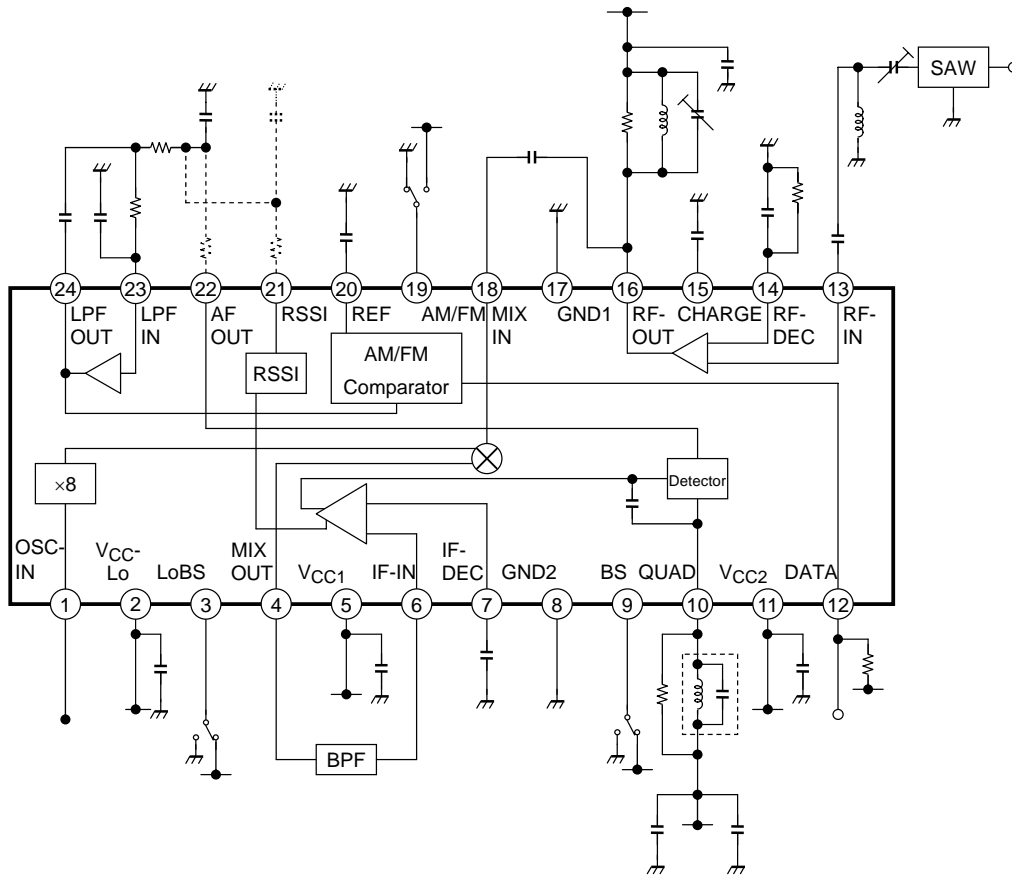

Pin Description

(the values of resistor and capacitor in the internal equivalent circuit are typical.)

Pin No.	Pin Name	Function	Internal Equivalent Circuit
1	OSC IN	Local oscillator input pin.	
2	VCC-Lo	Local power supply pin	—
3	LOBS	Lo switch pin. H: x8 circuit pin. L: Through pass	
4	MIX OUT	Mixer output pin. The output impedance of the pin is typically 330 Ω.	
5	VCC1	Power supply pin 1.	—
6	IF IN	IF amp input pin.	
7	IF DEC	IF amp input pin. Used as a bias coupling pin.	
8	GND2	GND pin 2.	—
9	BS	Battery saving pin.	

Pin No.	Pin Name	Function	Internal Equivalent Circuit
10	QUAD	Phase-shift input terminal for the FSK Demodulator. Connect to the discriminator or LC.	
11	V _{CC2}	Power supply pin 2.	—
12	DATA	FM/AM waveform shaping output pin. Open collector output. Connect a pull-up resistor.	
13	RF IN	RF signal input pin.	
14	RF DEC	Emitter pin for internal transistor.	
16	RF OUT	RF amp output pin.	
15	CHARGE	Control terminal for quick charge circuit. To use the quick charge circuit, attach a capacitor.	
17	GND1	GND pin 1.	—
18	MIX IN	Mixer input pin.	
19	AM/FM	Changeover switch for ASK/FSK. Hi: AM Lo: FM	

Pin No.	Pin Name	Function	Internal Equivalent Circuit
20	REF	Threshold input terminal for 2-level FM/AM comparator.	
21	RSSI	RSSI output pin.	
22	AFOUT	Output terminal for FM demodulator.	
23	LPF IN	FM/AM LPF input pin.	
24	LPF OUT	FM/AM LPF output pin.	

Equivalent circuits are given to help understand design of the external circuits to be connected. They do not accurately represent the internal circuits.

Functions

1. Waveform Shaper Circuit (comparator)

The output data (pin 12) are inverted.

2. RSSI Function

DC potential corresponding to the input level of IF IN (pin 6) is output to RSSI (pin 21). Output to RSSI (pin 21) is converted to a voltage by the internal resistance. Thus, connecting external resistance R to pin 21 varies the gradient of the RSSI output as shown below. Note that due to the displacement of temperature coefficients between external resistor R and the internal IC resistor IC resistor, the temperature characteristic of the RSSI output may change. Also, the maximum RSSI value should be $V_{CC} - 1\text{ V}$ or less, because AM doesn't correct movement Filter AMP when voltage of RSSI high.

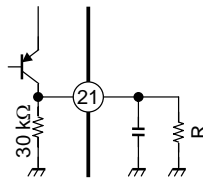

Figure 1

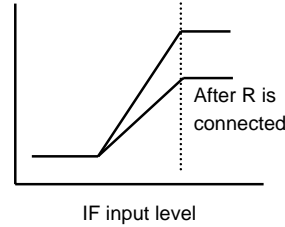

Figure 2

3. VCC Pin and GND Pin

Use the same voltage supply for $V_{CC} - Lo$ (2 pin) and V_{CC1} (5 pin) and V_{CC2} (11 pin) (or connect them). Also, use the same voltage supply source for $GND1$ (17 pin) and $GND2$ (8 pin) (or connect them).

4. Local Oscillator Circuit

The local oscillator circuit is external-input-only. The device incorporates no transistor for oscillation. Input to pin 1 at a level from 95 to 105dB μ V.

Adjust the values of constants C107 and C108 shown in the application circuit diagram so that the input level will become approximately 100dB μ V.

By switching the Lo switch (LOBS), the frequency set by the external circuit can be used as-is without using the $\times 8$ circuit.

Lo Switch (LOBS)	H	L
Local oscillation status	$\times 8$ circuit in operation	$\times 8$ circuit halted/through pass

5. RF Amp Current Adjustment

The RF amp current dissipation can be regulated by varying resistor R as shown in the figure below. When $R = 1\text{ k}\Omega$, the current dissipation is approximately 600 μ A.

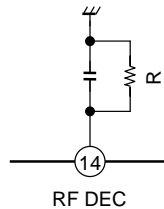

Figure 3

6. Battery-Saving (BS) Function and Lo Switch LOBS Function

The IC incorporates a battery-saving function and a Lo switch function. These function offer the following selection.

FM Mode (FM/AM pin: L)

BS Pin/LOBS Pin	Circuit Status in the IC	IC Current Dissipation (at no signal)
H/H	Circuits in operation: <ul style="list-style-type: none"> • ×8 circuit • Mixer • RF amp • Comparator • IF amp • Detector circuit • RSSI • Comparator capacitor charger circuit 	5.8 mA (typ.)
H/L	×8 circuit only halted, Frequency set by External circuit can be used as-is.	3.5 mA (typ.)
L/H	×8 circuit only in operation	2.6 mA (typ.)
L/L	All circuits	0 mA (typ.)

AM Mode (FM/AM pin: H)

BS Pin/LOBS Pin	Circuit Status in the IC	IC Current Dissipation (at no signal)
H/H	Circuits in operation: <ul style="list-style-type: none"> • ×8 circuit • Mixer • RF amp • Comparator • IF amp • RSSI • Comparator capacitor charger circuit 	5.4 mA (typ.)
H/L	×8 circuit only halted, Frequency set by External circuit can be used as-is.	3.1 mA (typ.)
L/H	×8 circuit only in operation	2.6 mA (typ.)
L/L	All circuits	0 mA (typ.)

7. RF Amp Gain 2

RF amp gain 2 ($G_v(RF) 2$) is a reference value calculated as follows. Measure G_{RF} in the following figure.

$G_v(RF) 2$ is calculated as follows:

$$G_v(RF) 2 = G_{RF} - G_v(MIX)$$

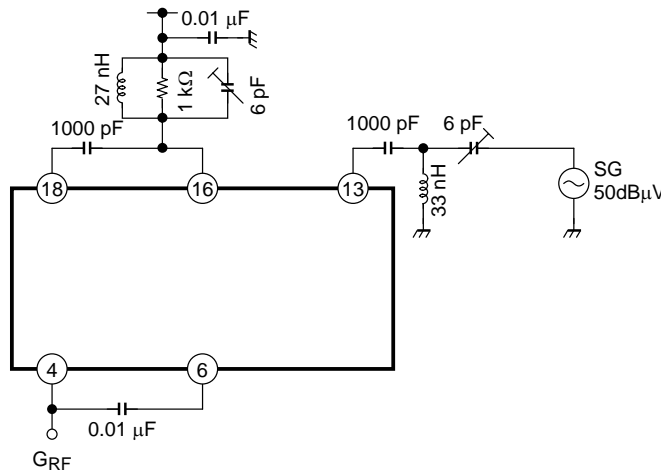

Figure 4

8. IF Amp Gain

The intended value is 75dB.

9. Waveform-Shaping Output Duty Cycle

The specified range of electrical characteristics is only available for single-tone.

10. Local Frequency Range (after multiplying frequency by 8)

When the multiplier circuit is used, the local frequency will be in the range 250.7 MHz to 439.3 MHz.

11. Treatment of FM Terminal when Using AM

When using AM, it is not necessary to treat the QUAD pin (pin 10). Leave it open or connected to an FM external circuit. To use the bit rate filter, connect the RSSI pin (pin 21) to the bit rate filter through a resistor. The AF-OUT pin (pin 22) should be left open.

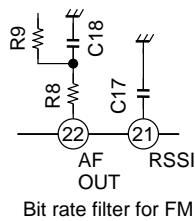

Figure 5

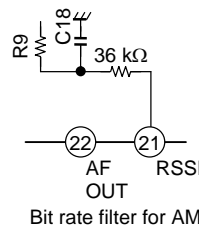

Figure 6

Using AM causes current to flow through the AM/FM pin (pin 19). Ground the AM/FM pin (pin 19) or connect it to the BS pin (pin 9).

12. Control Terminal for Quick Charge Circuit (CHARGE)

CHARGE (15 pin) is control terminal for quick charge circuit. REF (20 pin) control terminal for quick charge a given period by time constant of internal resistance and outside capacitance. Enabling the CHARGE pin requires an external capacitor. In normal operation, connect a capacitor having the same capacitance as that of the capacitor connected to the REF pin (pin 20).

If the connected external capacitor (C11) is 0.1 μ F, the quick charge time is 7 ms (typically).

13. Bit Rate Filter for FM

The current FM bit rate filter is used as a tertiary filter.

If the filter is to be used at a rate other than 1200 bps, please change the filter constant.

Quadratic Filter (NRZ)

	R10	R9	R8	C20	C19	C18
1200 bps	68 k Ω	68 k Ω	68 k Ω	0.01 μ F	560 pF	3300 pF
2400 bps	68 k Ω	68 k Ω	68 k Ω	4700 pF	270 pF	1500 pF
4800 bps	68 k Ω	68 k Ω	68 k Ω	2200 pF	150 pF	680 pF

14. Bit Rate Filter for AM

The current AM bit rate filter is used as a quadratic filter.

If the filter is to be used at a rate other than 1200 bps, please change the filter constant.

Quadratic Filter (NRZ)

(the bit rate filter time constant takes into account the internal resistance RSSI (30 k Ω))

	R	R10	C20	C19
1200 bps	36 k Ω	68 k Ω	4700 pF	1500 pF
2400 bps	36 k Ω	68 k Ω	2200 pF	680 pF
4800 bps	36 k Ω	68 k Ω	1000 pF	390 pF

When the filter constants shown below are used, it is not necessary to set the R constant value.

	R	R10	C20	C19
1200 bps	—	30 k Ω	6800 pF	2200 pF
2400 bps	—	30 k Ω	3300 pF	1500 pF
4800 bps	—	30 k Ω	1800 pF	820 pF

In addition, the current AM bit rate filter can be used as a tertiary filter.

If the filter is to be used at a rate other than 1200 bps, please change the filter constant.

Quadratic Filter (NRZ)

(the bit rate filter time constant takes into account the internal resistance RSSI (30 kΩ))

	R	R9	R10	C20	C19	C18
1200 bps	36 kΩ	68 kΩ	68 kΩ	0.01 μF	560 pF	3300 pF
2400 bps	36 kΩ	68 kΩ	68 kΩ	4700 pF	270 pF	1500 pF
4800 bps	36 kΩ	68 kΩ	68 kΩ	2200 pF	150 pF	680 pF

When the filter constants shown below are used, it is not necessary to set the R constant value.

	R	R9	R10	C20	C19	C18
1200 bps	—	30 kΩ	30 kΩ	0.033 μF	2200 pF	8200 pF
2400 bps	—	30 kΩ	30 kΩ	0.015 μF	1000 pF	3900 pF
4800 bps	—	30 kΩ	30 kΩ	6800 pF	470 pF	1800 pF

For the cutoff frequency of the bit rate filter, specify a sufficiently high value for the bit rate to be used. Specifying a relatively high cutoff frequency for the bit rate filter enables a low capacitor to be used at the REF pin, therefore making the pulse rise quickly.

When AM is used, the internal resistance of RSSI is used. So, take the output resistance into account when specifying a cutoff frequency.

Cautions for Designing Circuit Board Patterns

Observe the following cautions when designing circuit patterns for this product.

Local Oscillator Circuit (pin 1)

Isolate the local oscillator circuit block sufficiently from the RF amp block.

Isolate the local oscillator circuit block securely so that its output will not get in the IF input, IF filter, or mixer input.

Do not place the local oscillator circuit block too close to the ceramic filter.

Subdivide the ground pattern for the local oscillator circuit block, and connect the subdivisions with thin lines.

Mixer Output Block (pin 4) to IF Input Block (pin 6)

Isolate the input and output patterns of the IF filter securely from each other.

Demodulator Circuit Block (pin 10)

Isolate the demodulator circuit block sufficiently from the IF input block (pin 6).

Do not place the LC too close to the IC device.

Data Output Block (pin 12)

Isolate the data output block sufficiently from the IF input block (pin 6).

Isolate the output pattern of the data output block from other circuits as much as possible, so any noise from a stage subsequent to the output will not affect them.

RF Amp Circuit Block

(1) Preventing RF amp oscillation

Do not place the patterns connected to pins 13 and 14 too close to each other.

Isolate the patterns connected to the input block (pin 13) and output block (pin 16) from each other.

Make the RF input signal line relatively thin.

Place a relatively wide ground pattern between the RF-IN pin (pin 13) and RF-DEC pin (pin 14).

Connect the RF-OUT pin (pin 16) and MIX-IN pin (pin 18) with the shortest possible pattern.

(2) Attaining a sufficient gain

To attain a sufficient RF amp gain, select an optimum value for the input matching circuit block (pin 13) according to the board circuit pattern.

IC Mounting Area

Provide a ground pattern under the IC device, and prepare relatively many through holes.

Maximum Ratings

(unless otherwise specified, Ta = 25°C. the voltage is with reference to the ground level.)

Characteristics	Symbol	Rating	Unit
Supply voltage	V _{CC}	6	V
Power dissipation	P _D	780	mW
Operating temperature range	T _{opr}	-40 to 85	°C
Storage temperature range	T _{stg}	-55 to 150	°C

The maximum ratings must not be exceeded at any time. Do not operate the device under conditions outside the above ratings.

Operable Range

(unless otherwise specified, Ta = 25°C. the voltage is with reference to the ground level.)

Characteristics	Symbol	Test Circuit	Test Condition	Min	Typ.	Max	Unit
Operating voltage range	V _{CC}	—	—	2.4	5.0	5.5	V
RF operating frequency 1	f _{RF1}	—	When frequency multiplication is used	240	—	450	MHz
RF operating frequency 2	f _{RF2}	—	When frequency multiplication is not used	100	—	450	MHz
Local frequency	f _{LO}	—	When frequency multiplication is used (x8)	250.7	—	439.3	MHz

Operating ranges indicate the conditions for which the device is intended to be functional even with the electrical changes.

Electrical Characteristics (unless otherwise specified: Ta = 25°C, V_{CC} = 5 V, fin (RF) = fin (MIX) = 314.9 MHz, fin (IF) = 10.7 MHz)

Characteristics	Symbol	Test Circuit	Test Condition	Min	Typ.	Max	Unit
Current dissipation at battery saving	I _{cco}	3	BS = "L", LOBS = "L"	—	0	5	μA
RF amp gain 1	G _v (RF) 1	1 (5)	The input and output impedances are 50 Ω.	-9.0	-6.0	-3.0	dB
Mixer conversion gain	G _v (MIX)	—	—	17	21	25	dB
RSSI output voltage 1	V _{RSSI1}	—	V _{in} (IF) = 35dBμVEMF	0.05	0.25	0.45	V
RSSI output voltage 2	V _{RSSI2}	—	V _{in} (IF) = 65dBμVEMF	0.8	1.05	1.3	V
RSSI output voltage 3	V _{RSSI3}	—	V _{in} (IF) = 100dBμVEMF	1.6	1.95	2.3	V
RSSI output resistance	R _{RSSI}	—	—	22	30	38	kΩ
Comparator input resistance	R _{COMP}	—	—	75	100	125	kΩ
Data output voltage (L level)	V _{DATAL}	1 (3)	I _{DATAL} = 500 μA	—	—	0.4	V
Data output leakage current (H level)	I _{DATAH}	1 (4)	—	—	—	2	μA
BS pin H-level input voltage	V _{BSH}	—	—	2.2	—	5.5	V
BS pin L-level input voltage	V _{BSL}	—	—	0	—	0.2	V
LOBS pin H-level input voltage	V _{LOBSH}	—	—	2.2	—	5.5	V
LOBS pin L-level input voltage	V _{LOBSL}	—	—	0	—	0.2	V

FM Mode (Ta = 25°C, V_{CC} = 5.0 V, fin (RF) = fin (MIX) = 314.9 MHz, fin (IF) = 10.7 MHz, dev = ±20 kHz, fmod = 600 Hz (single wave))

Characteristics	Symbol	Test Circuit	Test Condition	Min	Typ.	Max	Unit
Quiescent current consumption (for FM)	I _{ccqfm}	2 (1)	BS/LOBS/FMAM = "H/H/L" Fin (Lo) = 40.7 MHz	4.3	5.8	7.3	mA
Demodulated output level	V _{od}	—	V _{in (IF)} = 80dBμVEMF	30	40	55	mVrms
Waveform shaping duty ratio	DR _{fm}	1 (2)	V _{in (IF)} = 80dBμVEMF For single tone	45	50	55	%

AM Mode (Ta = 25°C, V_{CC} = 5.0 V, fin (RF) = fin (MIX) = 314.9 MHz, fin (IF) = 10.7 MHz, AM = 90%, fmod = 600 Hz (square wave))

Characteristics	Symbol	Test Circuit	Test Condition	Min	Typ.	Max	Unit
Quiescent current consumption (for AM)	I _{ccqam}	2 (2)	BS/LOBS/FMAM = "H/H/H" Fin (Lo) = 40.7 MHz	4.0	5.4	6.8	mA
Reference characteristic data	DR _{am}	1 (2)	V _{in (IF)} = 80dBμVEMF For single tone	45	50	55	%

Reference Characteristic Data*

Characteristics	Symbol	Test Circuit	Test Condition	Typ.	Unit
IF amp input resistance	R _{(IF) IN}	—	—	330	Ω
RF amp gain 2	G _{v (RF) 2}	—	—	31	dB
RF amp input resistance	R _{(RF) IN}	—	—	1.2	kΩ
RF amp input capacitance	C _{(RF) IN}	—	—	2.0	pF
RF amp output capacitance	C _{(RF) OUT}	—	—	2.0	pF
Mixer input resistance	R _{(MIX) IN}	—	—	1.5	kΩ
Mixer input capacitance	C _{(MIX) IN}	—	—	1.5	pF
Mixer output resistance	R _{(MIX) OUT}	—	—	330	Ω
Mixer intercept point	IP ₃	—	—	96	dBμV

*: These characteristic data values are listed just for reference purposes. They are not guaranteed values.

Reference Characteristic Data (FM mode)*

Characteristics	Symbol	Test Circuit	Test Condition	Typ.	Unit
Limiting sensitivity	V _{i (LIM)}	—	IF input	35	dBμV EMF
Signal-to-noise ratio 1	S/N ₁	1 (8)	V _{in (IF)} = 40dBμVEMF	40	dB
Signal-to-noise ratio 2	S/N ₂	1 (8)	V _{in (IF)} = 80dBμVEMF	57	dB

*: These characteristic data values are listed just for reference purposes. They are not guaranteed values.

Typical Test Circuit (FSK)

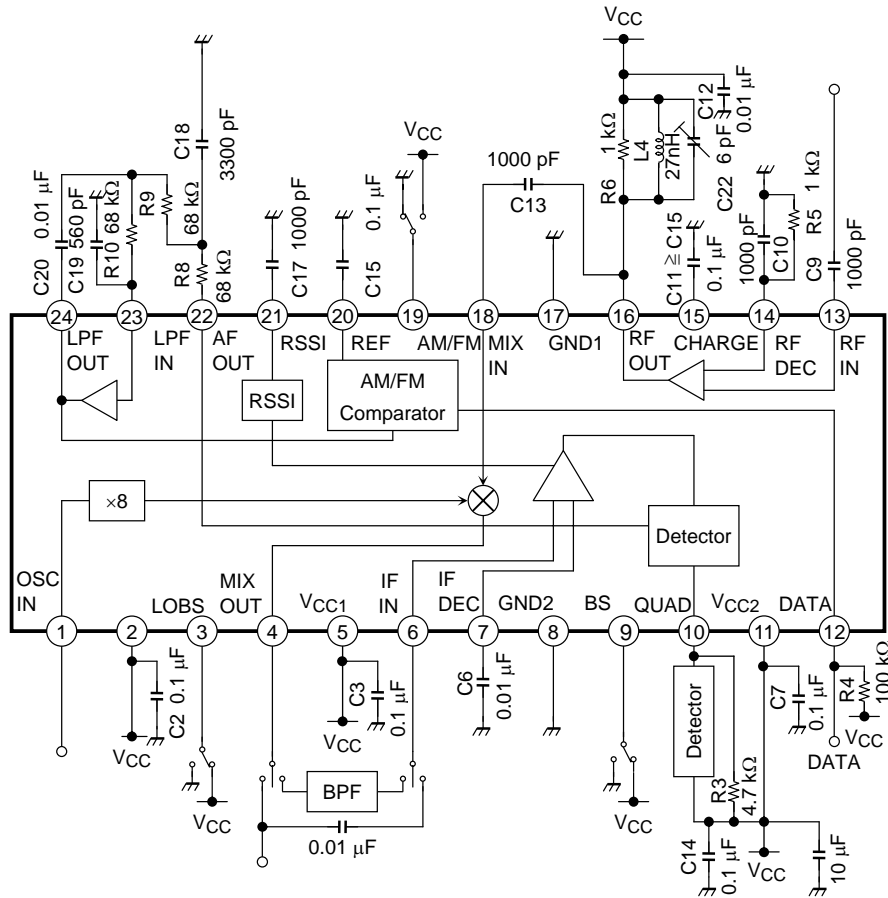

Test Circuit 1

(1) VRSSI

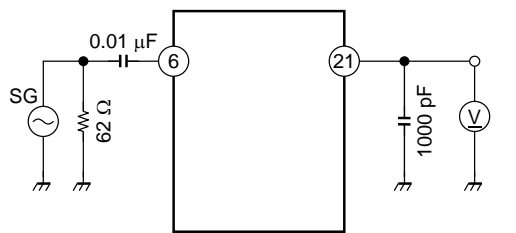

(2) DR

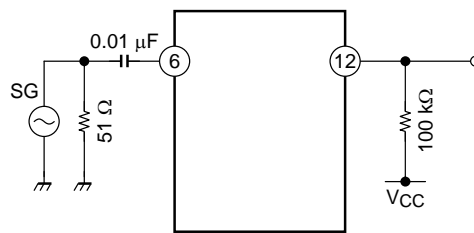

(3) VDATAL

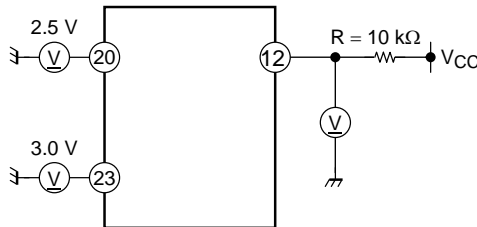

(4) IDATAH

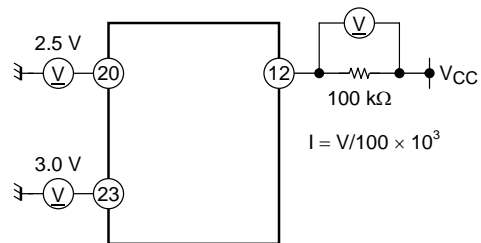

(5) G_v (RF) 1

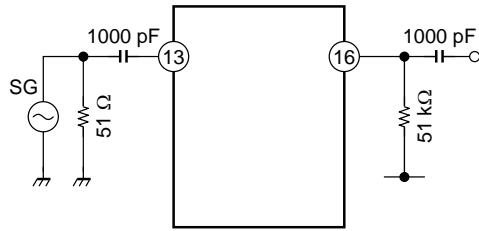

(6) G_v (MIX)

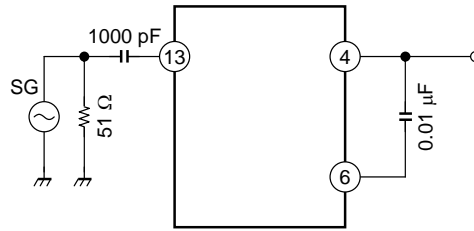

(7) G_v (MIX) vs VLO

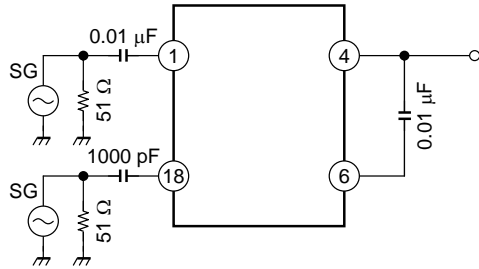

(8) S/N1, 2

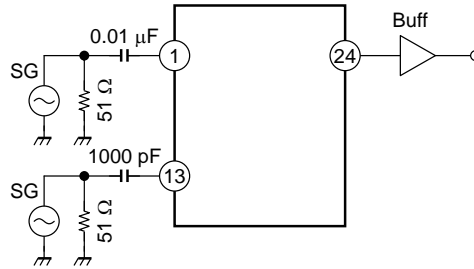

Test Circuit 2

I_{ccqfm}

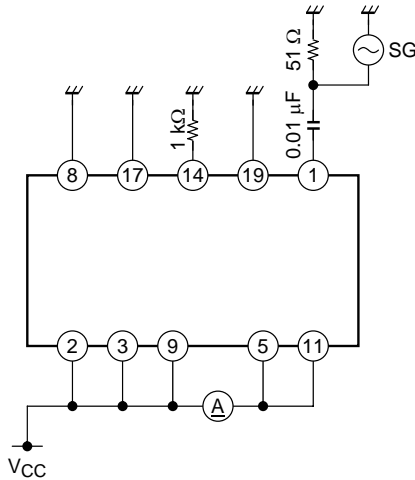

I_{ccqam}

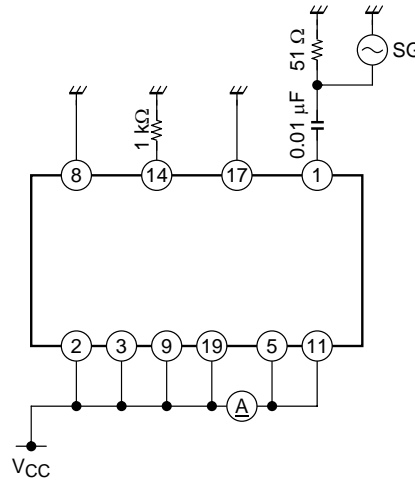

Test Circuit 3

I_{cco}

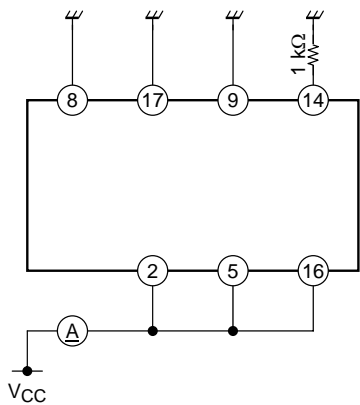

Reference Data (This is characteristics data when it used evaluation boards. This is not guarantee on condition that it is stating except electrical characteristics.)

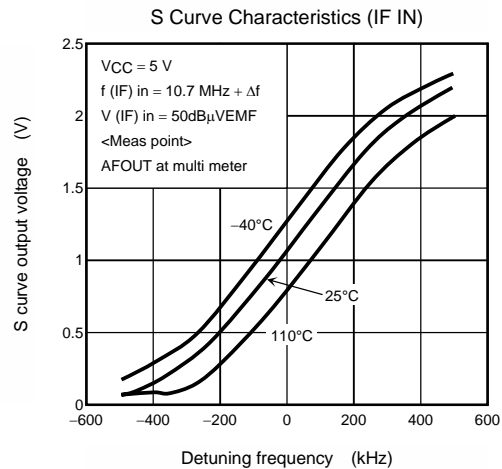
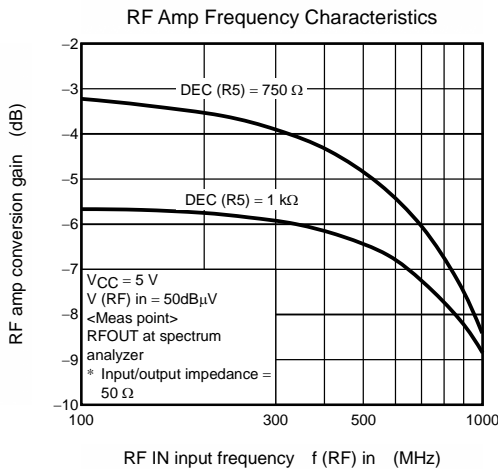
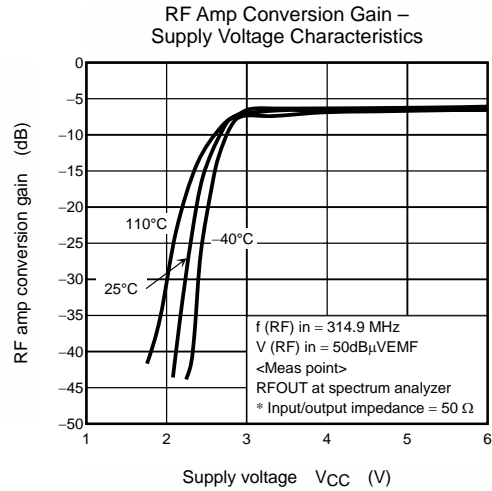
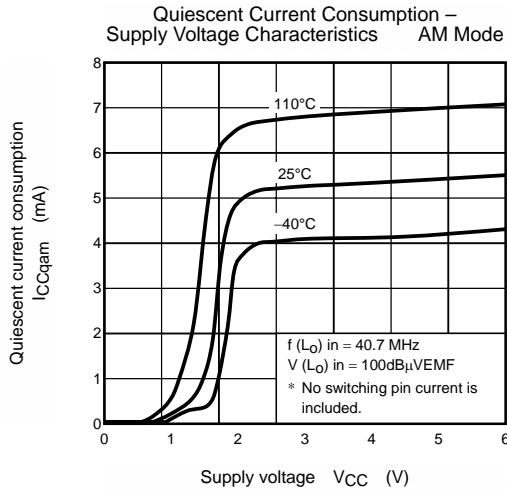
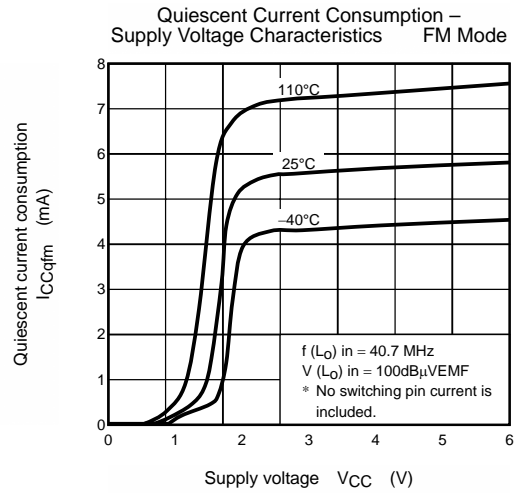
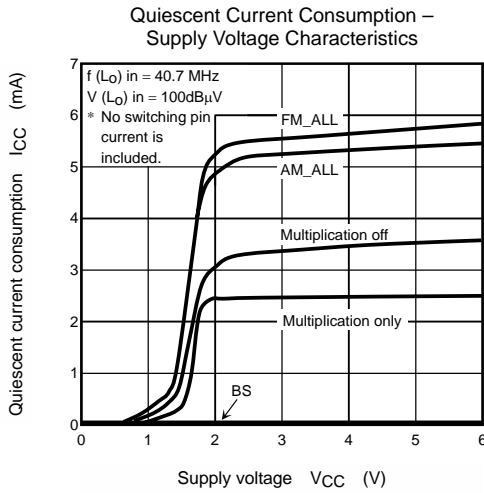

Reference Data (This is characteristics data when it used evaluation boards. This is not guarantee on condition that it is stating except electrical characteristics.)

RSSI Output Voltage Characteristics (IF, MIX, and RF inputs)

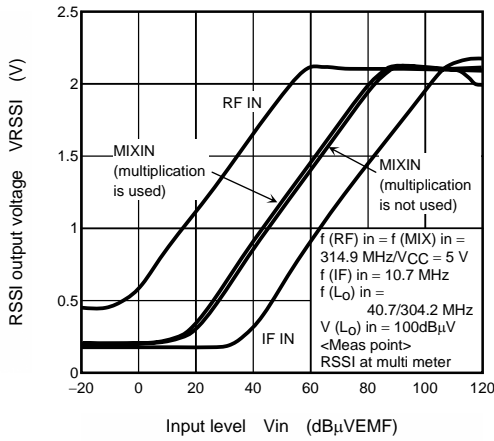

RSSI Output Voltage Characteristics (MIX inputs)

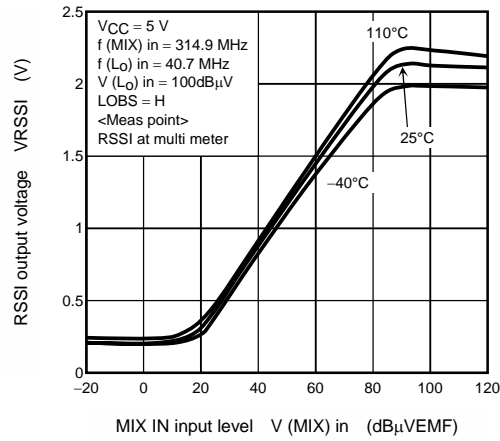

S/N Characteristics (IF input) in the FM Mode

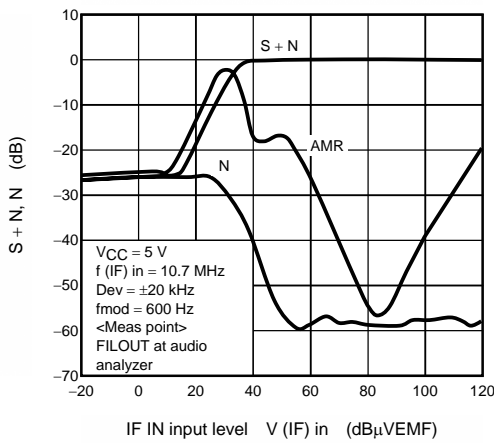

S/N Characteristics (IF input) in the AM Mode

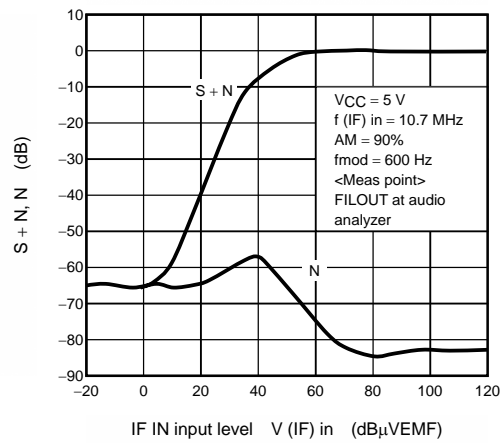

S/N Characteristics (MIX input) in the AM Mode when Multiplication is Used

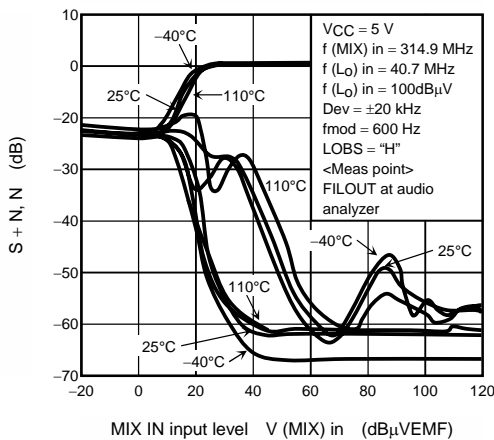

S/N Characteristics (MIX input) in the AM Mode when Multiplication is Used

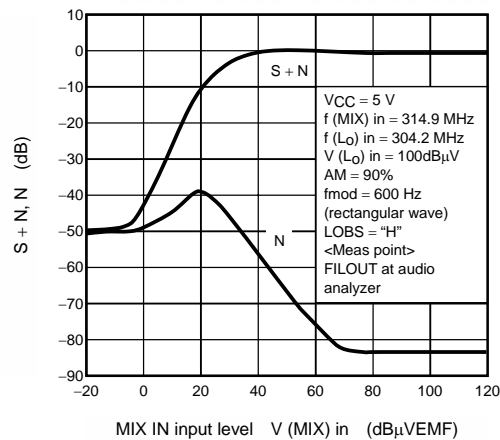

Reference Data (This is characteristics data when it used evaluation boards. This is not guarantee on condition that it is stating except electrical characteristics.)

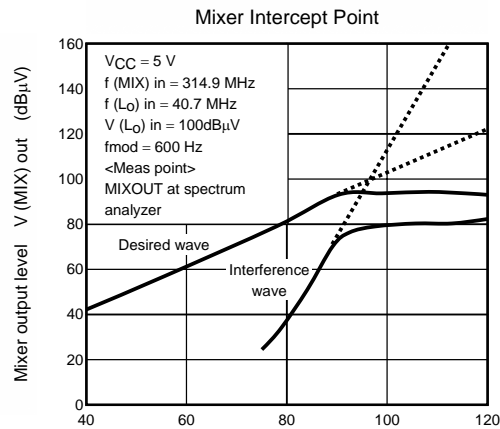
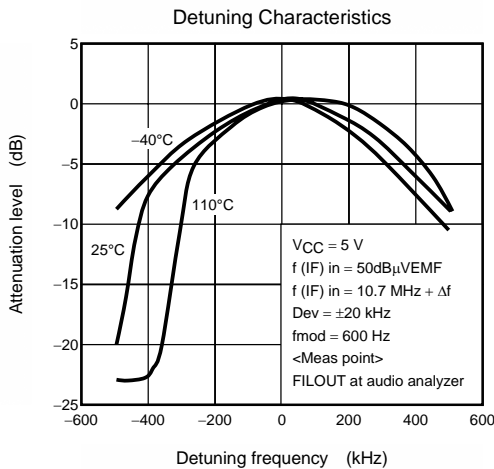
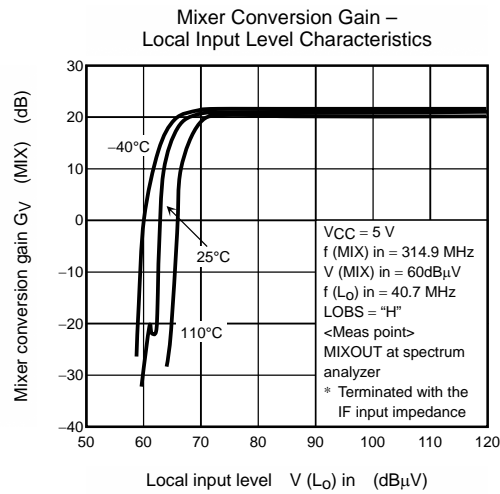
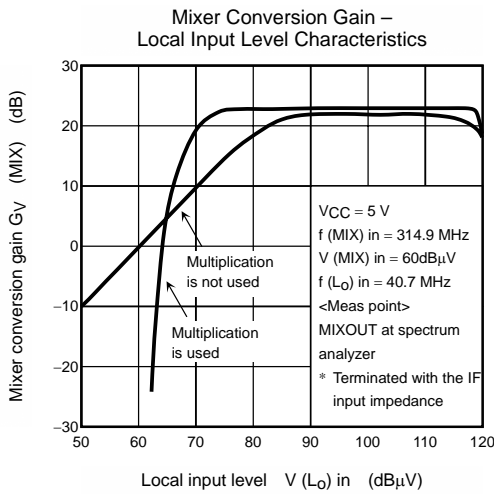
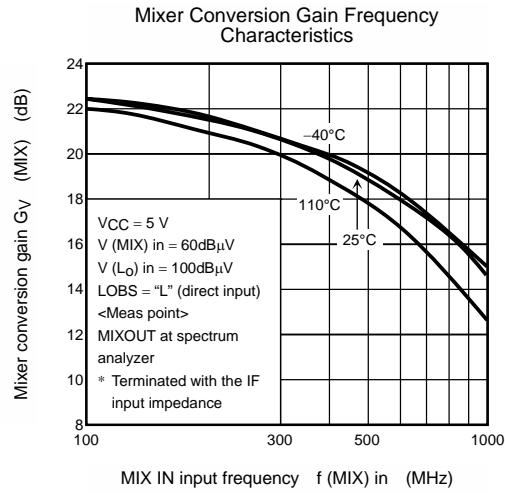
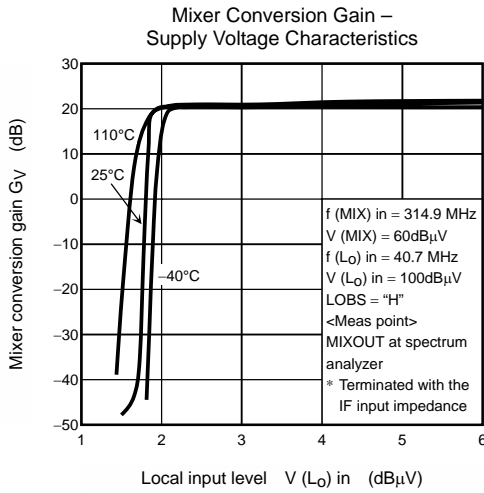

Reference Data (This is characteristics data when it used evaluation boards. This is not guarantee on condition that it is stating except electrical characteristics.)

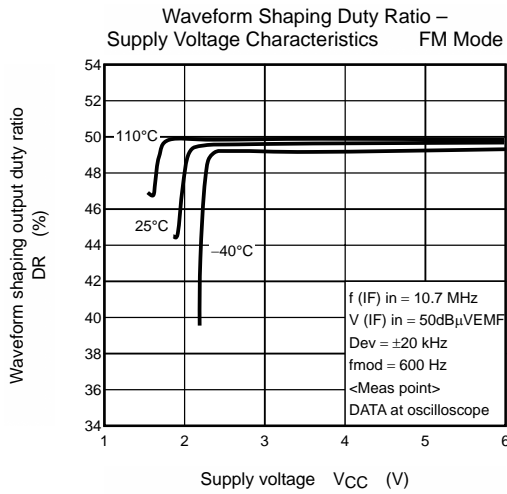
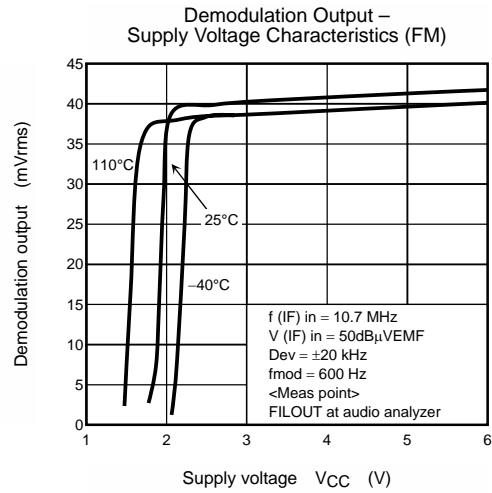
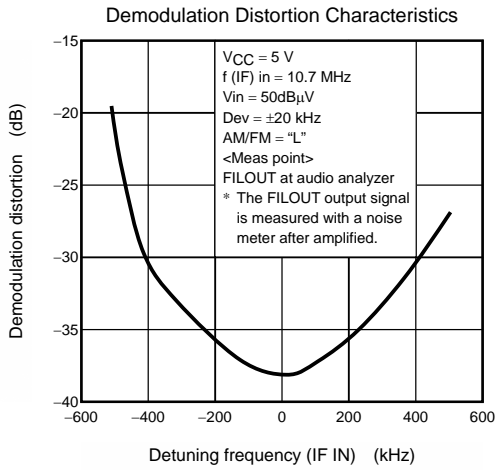

Reference Data (with a broadband ceramic filter (280 k) used)

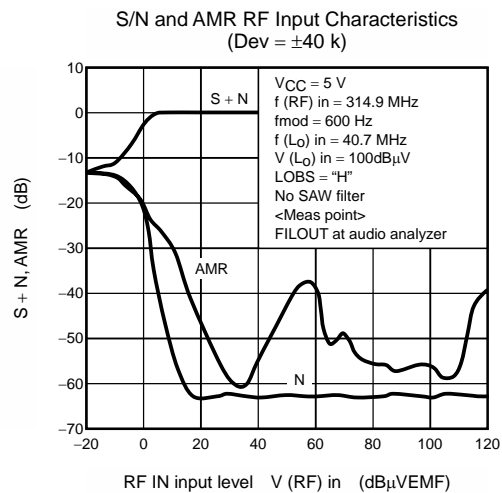
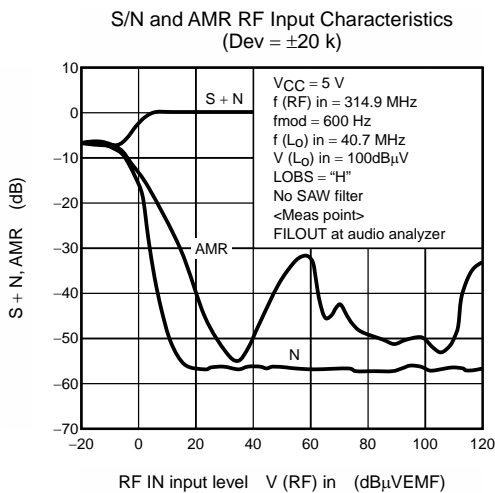
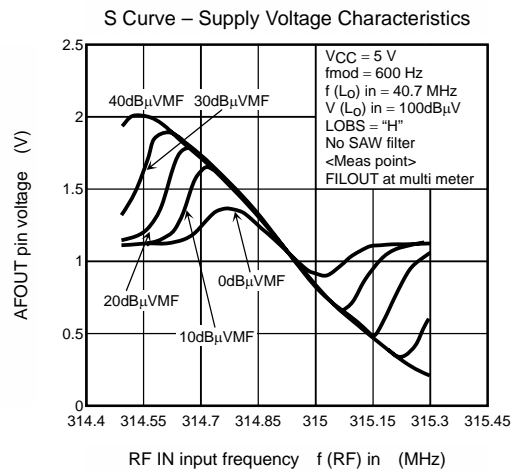
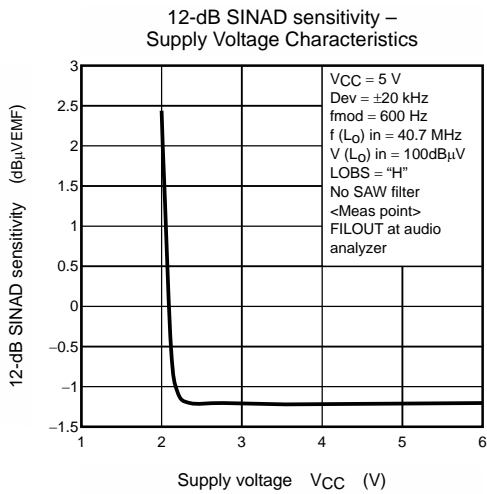
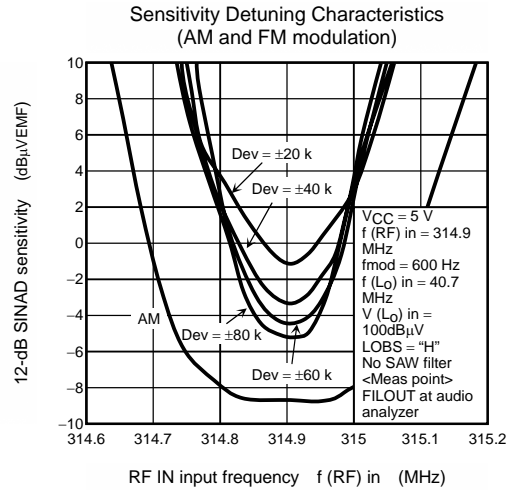
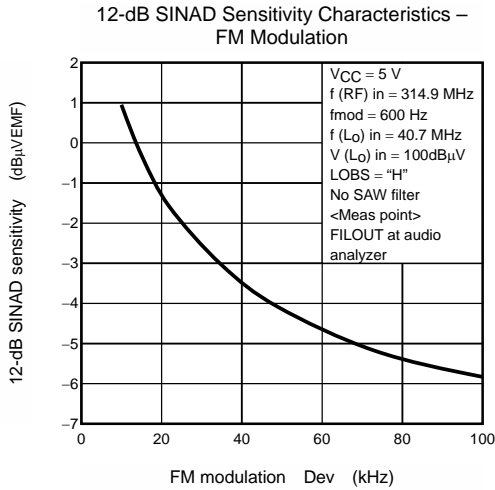

Reference Data (with a broadband ceramic filter (280 k) used)

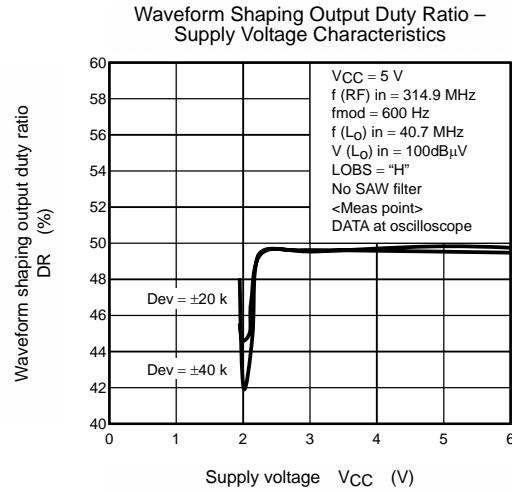
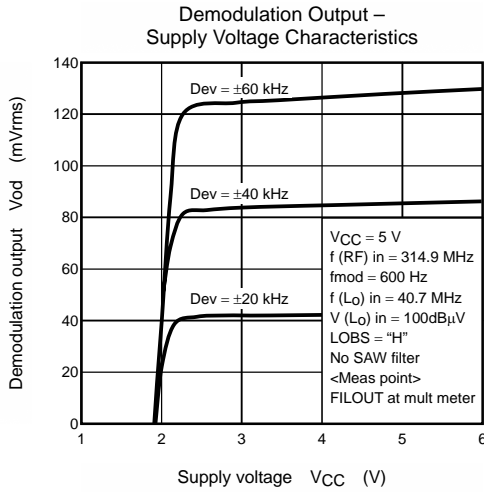

Reference Data (with a narrowband ceramic filter (150 k) used)

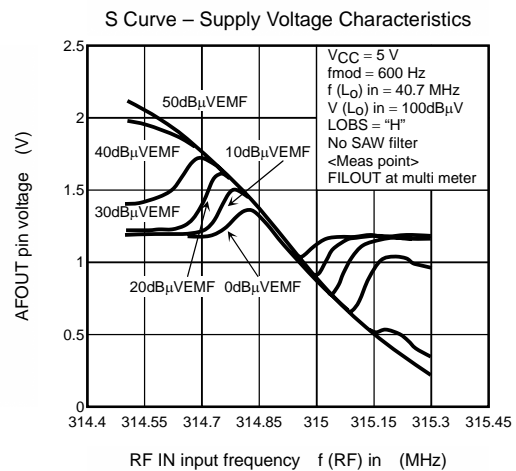
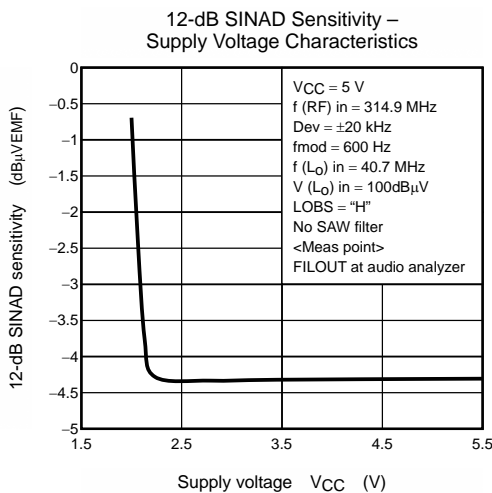
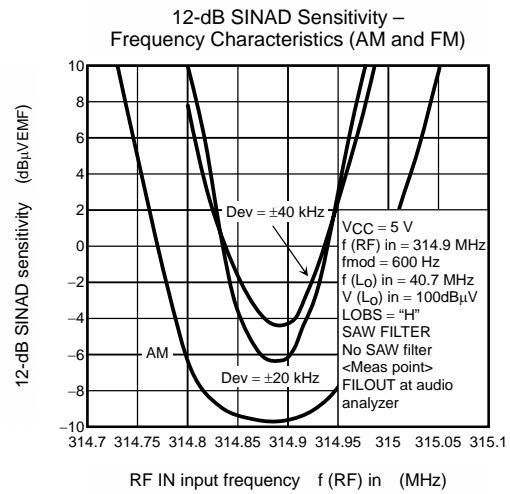
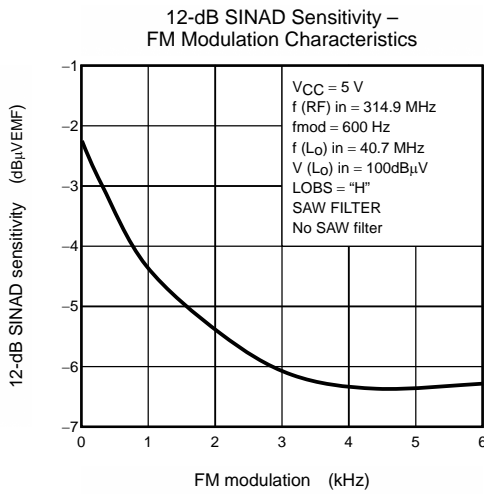

Reference Data (with a narrowband ceramic filter (150 k) used)

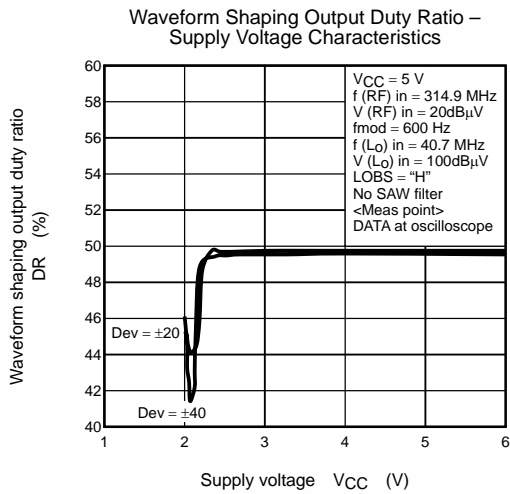
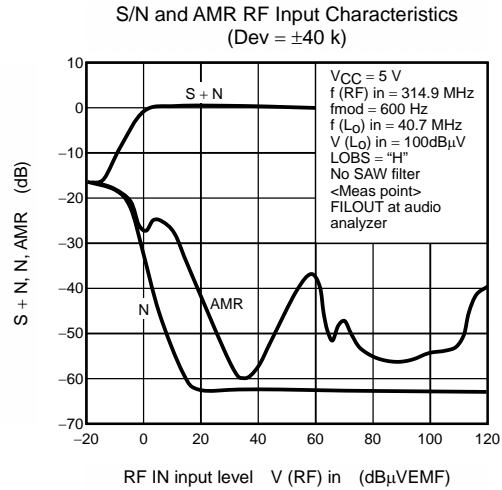
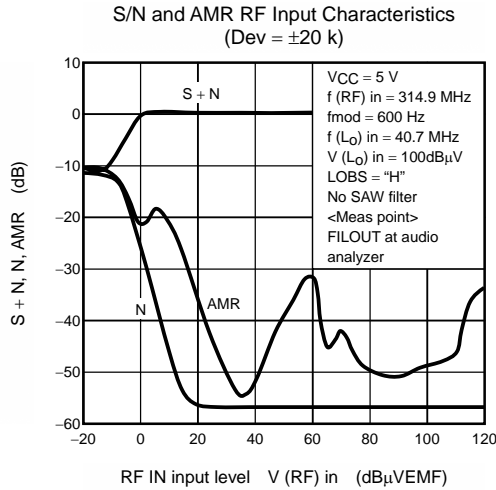

Application Circuit (FSK)

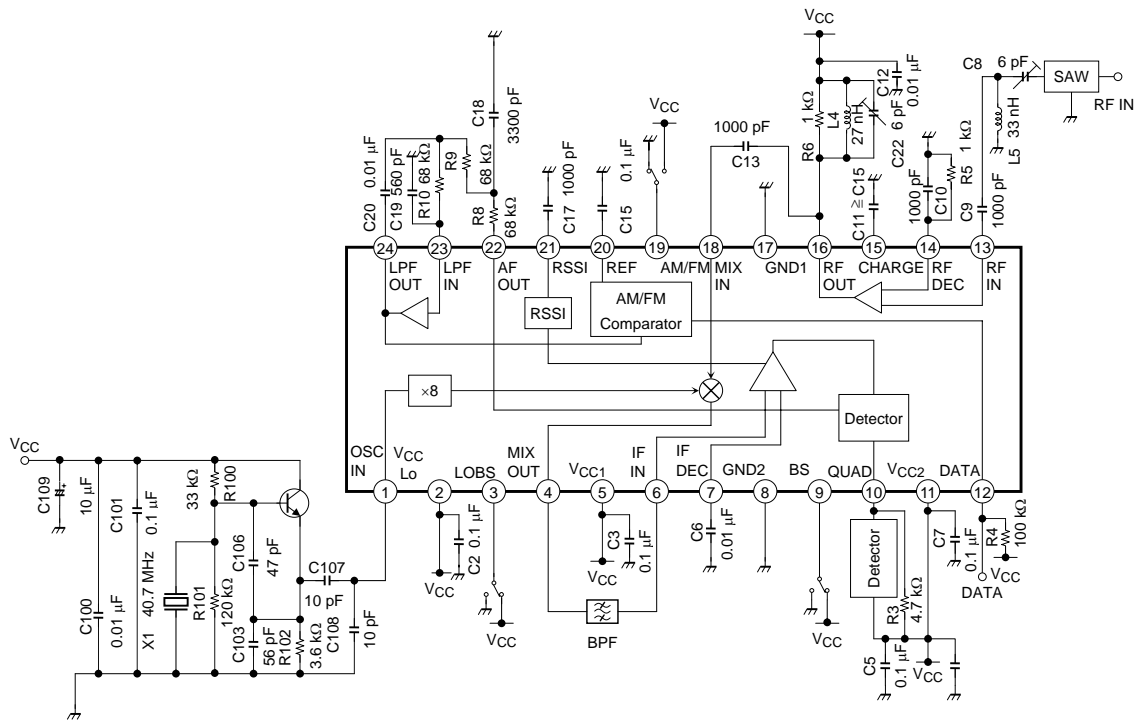

CF: SFELA10M7FA00-B0 (Murata Mfg. Co., Ltd.)--broadband (280 k)
 SFELA10M7JAA0-B0 (Murata Mfg. Co., Ltd.)--narrowband (150 k)
 LC: P-5DJ (Sumida Corporation)

Application Circuit (ASK)

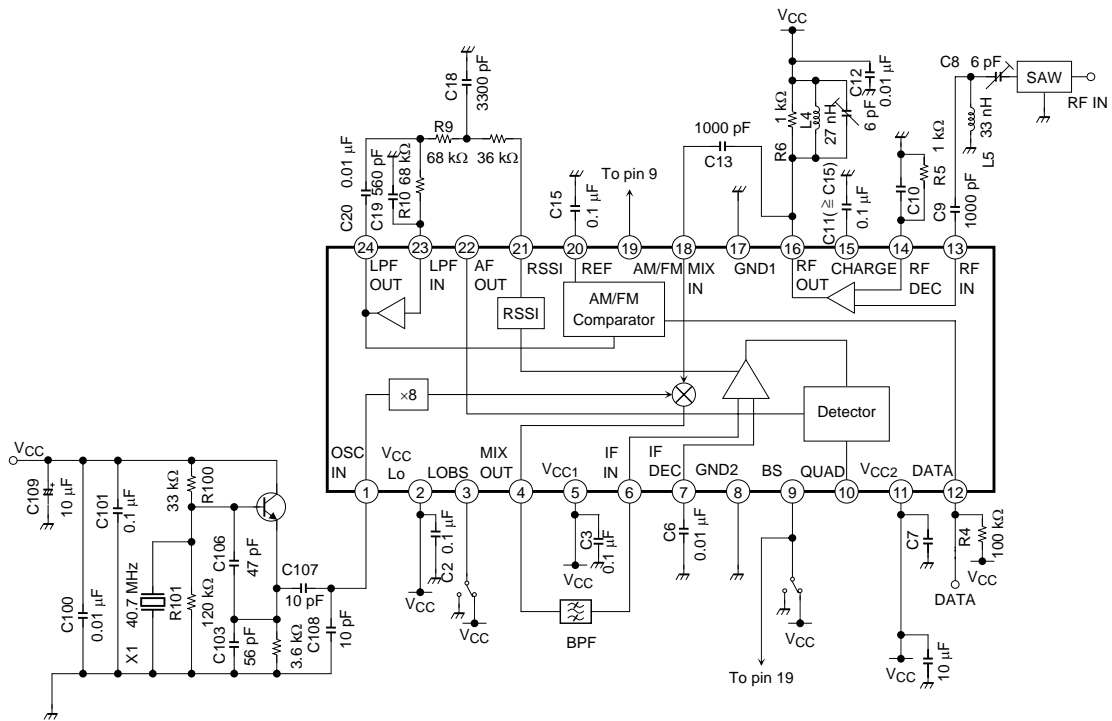

CF: SFELA10M7FA00-B0 (Murata Mfg. Co., Ltd.)--broadband (280 k)
 SFELA10M7JAA0-B0 (Murata Mfg. Co., Ltd.)--narrowband (150 k)

Package Dimensions

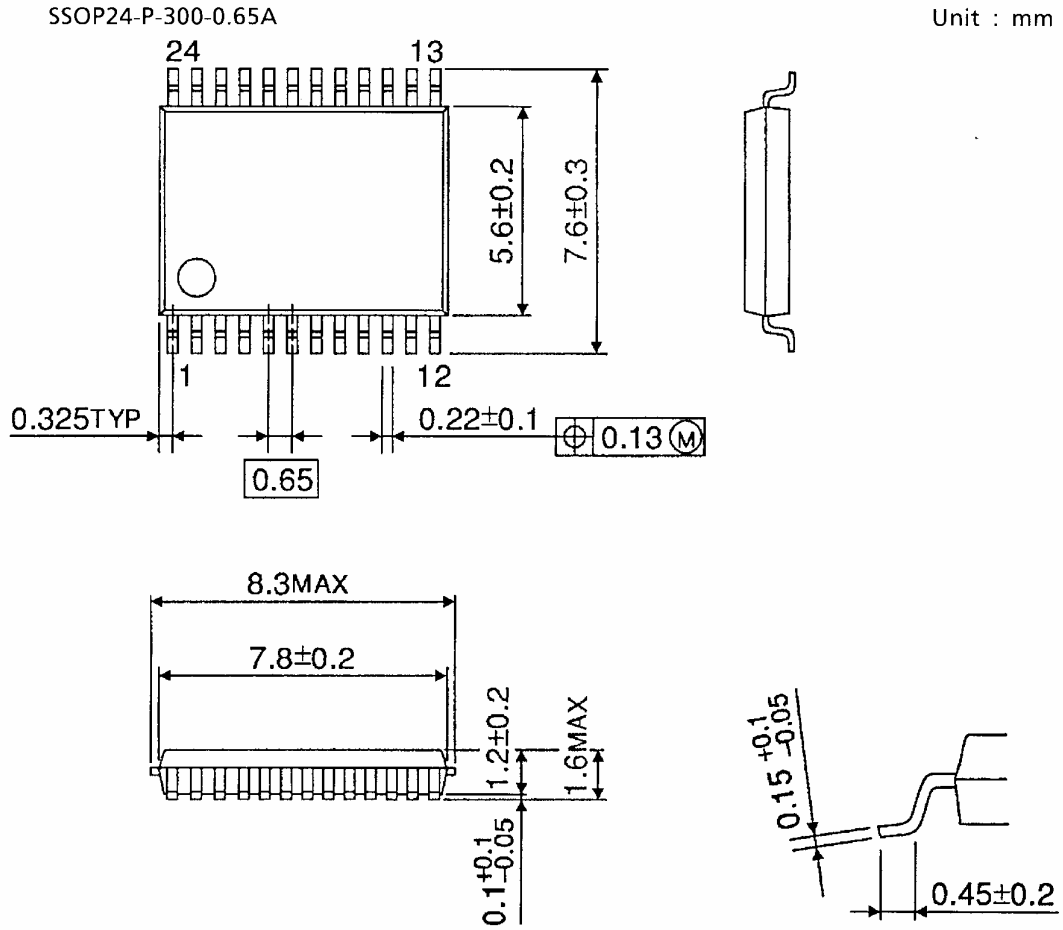

Weight: 0.09 g (typ.)

RESTRICTIONS ON PRODUCT USE

000707EBA

- TOSHIBA is continually working to improve the quality and reliability of its products. Nevertheless, semiconductor devices in general can malfunction or fail due to their inherent electrical sensitivity and vulnerability to physical stress. It is the responsibility of the buyer, when utilizing TOSHIBA products, to comply with the standards of safety in making a safe design for the entire system, and to avoid situations in which a malfunction or failure of such TOSHIBA products could cause loss of human life, bodily injury or damage to property.
In developing your designs, please ensure that TOSHIBA products are used within specified operating ranges as set forth in the most recent TOSHIBA products specifications. Also, please keep in mind the precautions and conditions set forth in the "Handling Guide for Semiconductor Devices," or "TOSHIBA Semiconductor Reliability Handbook" etc..
- The TOSHIBA products listed in this document are intended for usage in general electronics applications (computer, personal equipment, office equipment, measuring equipment, industrial robotics, domestic appliances, etc.). These TOSHIBA products are neither intended nor warranted for usage in equipment that requires extraordinarily high quality and/or reliability or a malfunction or failure of which may cause loss of human life or bodily injury ("Unintended Usage"). Unintended Usage include atomic energy control instruments, airplane or spaceship instruments, transportation instruments, traffic signal instruments, combustion control instruments, medical instruments, all types of safety devices, etc.. Unintended Usage of TOSHIBA products listed in this document shall be made at the customer's own risk.
- The products described in this document are subject to the foreign exchange and foreign trade laws.
- The information contained herein is presented only as a guide for the applications of our products. No responsibility is assumed by TOSHIBA CORPORATION for any infringements of intellectual property or other rights of the third parties which may result from its use. No license is granted by implication or otherwise under any intellectual property or other rights of TOSHIBA CORPORATION or others.
- The information contained herein is subject to change without notice.