

# MODELS

## SS103VD, SFN06VD

Voltage divider circuit  
Thin film resistor network  
RoHS compliant available

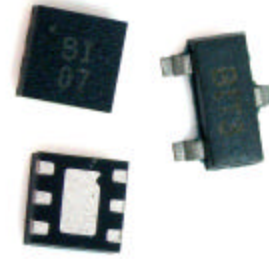

### FEATURES

Precision Nichrome Resistors on Silicon	Passivation coating provides protection in humid environments
Industry Standard Packaging	6 pad SON <sup>1</sup> 2mm square with 0.65 mm pitch (JEDEC MO-229D) 3 lead SOT23 (JEDEC TO-239)
Ratio Tolerances	< ± 0.05%
TCR Tracking Tolerances	< ± 5 ppm/°C

### CIRCUIT SCHEMATIC

3 lead SOT23

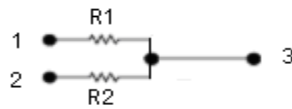

6 pad SON 2mm square

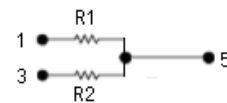

### ELECTRICAL<sup>2</sup>

Standard Resistance Range	1K ohms to 100K ohms
Resistor Tolerances	± 0.25%
Ratio Tolerances	± 0.05%
TCR	Reference TCR table
Operating Temperature Range	-55°C to +125°C
Interlead Capacitance	< 2 pF
Insulation Resistance	= 10,000 Megohms
Maximum Operating Voltage	100 Vdc or v PR
Noise, Maximum (MIL-STD-2002, Method 308)	-25 dB
Maximum Package Power @ 70°C	0.2 Watts

### RESISTANCE TOLERANCES

Accuracy Code at 25°C	CA	CB	D	FA	F	G	J
Absolute Resistance Tolerances (%)	± 0.25	± 0.25	± 0.5	± 1.0	± 1.0	± 2.0	± 5.0
Ratio Tolerances (R1 Ref) (%)	± 0.05	± 0.1	± 0.1	± 0.05	± 1.0	N/A	N/A

<sup>1</sup> Small outline no lead (SON) package is also referred to as quad flat no lead (QFN) or dual flat no lead (DFN) packages.

<sup>2</sup> Specifications subject to change without notice.

**BI Technologies Corporation**

4200 Bonita Place  
Fullerton, CA 92835 USA

Website: [www.bitechnologies.com](http://www.bitechnologies.com)

May 6, 2009



## TEMPERATURE COEFFICIENT OF RESISTANCE (TCR)

TCR Code (-55°C to 125°C)	Q	P	S	L
Absolute (ppm/°C)	± 25	± 50	± 100	± 200
Tracking (R1 Ref) (ppm/°C)	± 5	± 5	N/A	N/A

## POWER DERATING CURVE

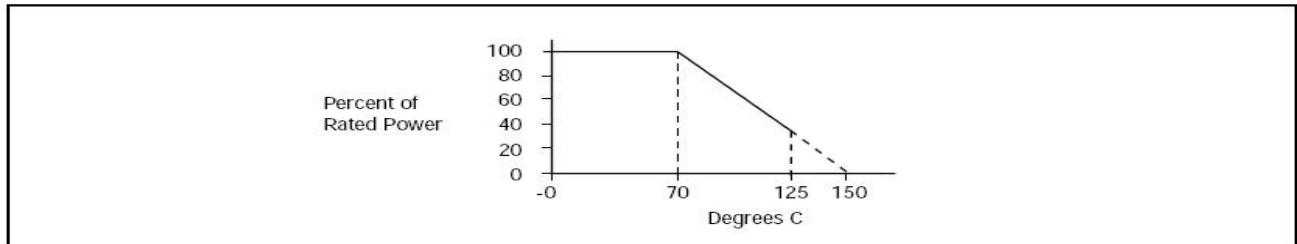

## ENVIRONMENTAL (MIL-R-83401)

Thermal Shock plus Power Conditioning	ΔR 0.25%
Short Time Overload	ΔR 0.1%
Moisture Resistance	ΔR 0.2%
Mechanical Shock	ΔR 0.25%
Vibration	ΔR 0.25%
Low Temperature Operation	ΔR 0.1%
High Temperature Exposure	ΔR 0.1%
Resistance to Solder Heat	ΔR 0.05%
Marking Permanency	Per MIL-STD-202, Method 215
Storage Temperature Range	-55°C to +125°C

## MECHANICAL

Lead Plating	80/20 Tin Lead (Standard) 100 matte Tin (RoHS)
Lead Material	Copper Alloy
Lead Configurations (SLP/SS1)	No lead, Gull Wing
Lead Coplanarity (SS1 only)	0.003" (0.102 mm)
Substrate Material	Silicon
Resistor Material	Passivated Nichrome
Body Material	Molded Epoxy
Package Types	6 pad SON 2mm square, 3 lead SOT23

**DIVIDER RATIO**

Resistance Code	Ratio (R2/R1)	R1 (ohms)	R2 (ohms)
01	1.613	12.4K	20K
02	10	10K	100K
03	4	5K	20K
05	1	20K	20K
06	9	11.3K	101.7K
07	2	10K	20K
08	3	3.333K	10K
09	2	5K	10K
10	1	10K	10K
11	2	1K	2K
12	2	50K	100K

**ORDERING INFORMATION<sup>3</sup>**

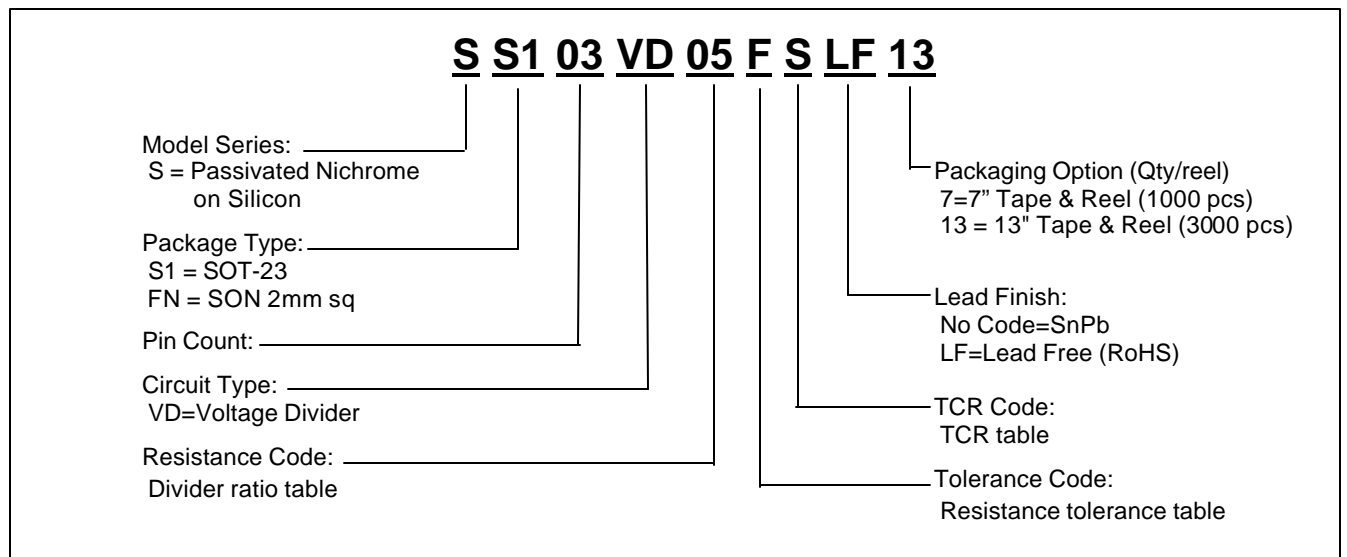

**TYPICAL MARKING**

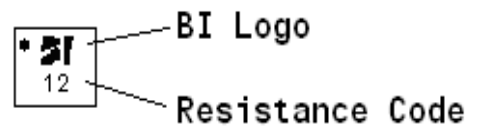
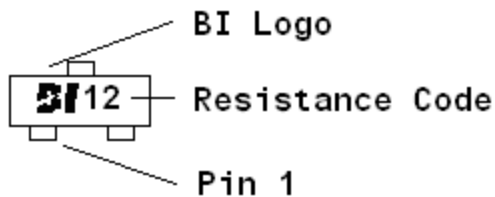

<sup>3</sup> Contact our customer service for custom designs and features.

**BI Technologies Corporation**

4200 Bonita Place  
Fullerton, CA 92835 USA

Website: [www.bitechnologies.com](http://www.bitechnologies.com)

May 6, 2009

