

Title	<i>Reference Design Report for Active Discharging of the X Capacitor for Reduced No-load Power Consumption Using CAPZero™ CAP014DG</i>
Specification	85 VAC – 264 VAC Input
Application	General Purpose
Author	Applications Engineering Department
Document Number	RDR-252
Date	April 14, 2010
Revision	1.0

Summary and Features

- Very low no-load input power (<5 mW actual dissipation)
- Passes surge testing to EN6100-4-5 Class 4 (2 kV DM / 4 kV CM)
- Safely discharges the X capacitor with a time constant of less than 1 second.

PATENT INFORMATION

The products and applications illustrated herein (including transformer construction and circuits external to the products) may be covered by one or more U.S. and foreign patents, or potentially by pending U.S. and foreign patent applications assigned to Power Integrations. A complete list of Power Integrations' patents may be found at www.powerint.com. Power Integrations grants its customers a license under certain patent rights as set forth at <<http://www.powerint.com/ip.htm>>.

Power Integrations

5245 Hellyer Avenue, San Jose, CA 95138 USA.

Tel: +1 408 414 9200 Fax: +1 408 414 9201

www.powerint.com

Table of Contents

1	Introduction.....	3
2	Specification	4
3	Schematic.....	5
4	Circuit Description	6
5	PCB Layout	7
6	Bill of Materials	8
7	No-load Input Power Performance	9
7.1	CAPZero IC Consumption (X Capacitor + MOV Removed From Board).....	10
7.2	No-load Consumption Including Effect of X Capacitor and MOV.....	11
7.3	No-load Input Power Including MOV and CAPZero (X Capacitor Removed)	12
8	X Capacitor Discharge Waveforms.....	13
8.1	AC Disconnect at Room Temperature.....	13
8.2	AC Disconnect at 105 °C Ambient.....	13
8.3	AC Disconnect at -5 °C Ambient	14
8.4	Input Arcing Test Room Temperature	15
8.5	AC Input Arcing Test at 105 °C Ambient	17
8.6	AC Input Arcing Test at -5 °C Ambient	19
9	AC Surge and Ring Wave Test.....	21
9.1	Ring Wave Test.....	21
9.2	Differential Mode Surge, 1.2 / 50 μsec	21
9.3	Common Mode Surge, 1.2 / 50 μsec.....	21
9.4	AC Disconnect Test After Surge.....	22
10	EMI Tests.....	23
11	Revision History	25

Important Note:

Although this board is designed to satisfy safety isolation requirements, the engineering prototype has not been agency approved. Therefore, all testing should be performed using an isolation transformer to provide the AC input to the prototype board.



1 Introduction

This engineering report describes a CAPZero™ demonstration board employing the Power Integrations CAP014DG. This demonstration board operates over a universal input range. It has been designed and tested to operate with an ambient temperature environment of up to 105 °C.

This document provides complete design details including specifications, the schematic, bill of materials. This information includes performance results, surge tests and EMI scans.

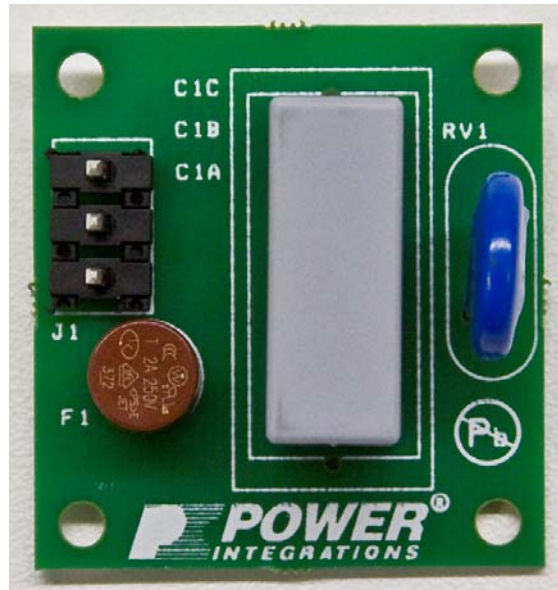

Figure 1 – Populated Circuit Board Photograph, Component Side.

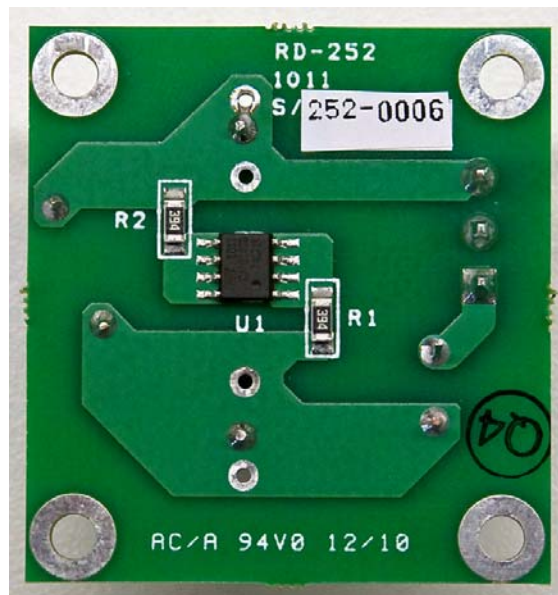

Figure 2 – Populated Circuit Board Photograph, Solder Side.



2 Specification

The table below represents the minimum acceptable performance of the design. Actual performance is listed in the results section.

Description	Symbol	Min	Typ	Max	Units	Comment
Input						
Voltage	V_{IN}	85		264	VAC	2 Wire – no P.E.
Frequency	f_{LINE}	47	50/60	63	Hz	
No-load Input Power (230 VAC)				0.08	W	Including MOV leakage and reactive current generated input cable losses
RC discharge time constant				1		second
Conducted EMI						Meets CISPR22B / EN55022B
Safety						Designed to meet IEC950 / UL1950 Class II
Line Surge						1.2/50 μ s surge, IEC 1000-4-5, Series Impedance:
Differential Mode (L1-L2)		2			kV	Differential Mode: 2 Ω
Common Mode (L1+L2-PE)		4			kV	Common Mode: 12 Ω
Ring Wave test						1.2/50 μ s surge, IEC 1000-4-5, Series Impedance:
Differential Mode (L1-L2)		1			kV	Differential Mode: 2 Ω
Ambient Temperature	T_{AMB}	-5		105	$^{\circ}$ C	Free convection, sea level



3 Schematic

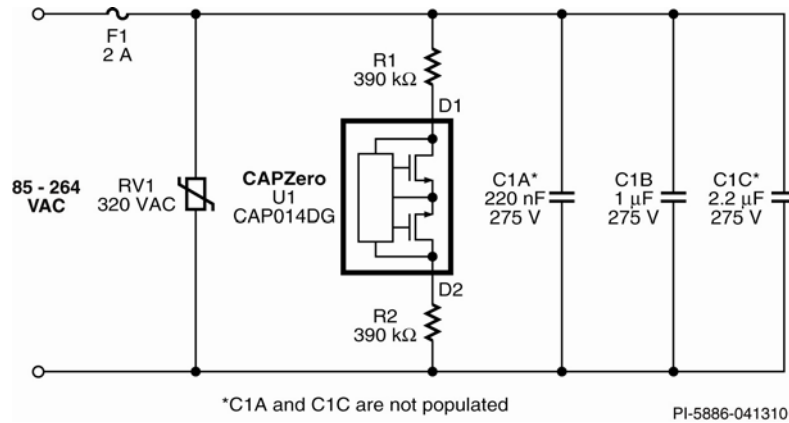

Figure 3 – Schematic.

*Note: C1A and C1C are optional components and are not populated on this board. These allow the board to be used in conjunction with larger or smaller X capacitors to test the functionality of larger or smaller devices.



4 Circuit Description

During normal operation, the controller within U1 detects the presence of AC input by detecting that the voltage between D1 and D2 is reversing polarity at fixed time intervals. Failure to detect polarity reversal is an indication of removal of AC input. This is used as a signal to turn on the MOSFETs within U1 and discharge the X capacitor. The values of resistors are chosen to guarantee that the time constant of the X capacitor and the discharge resistors is less than 1 second.



5 PCB Layout

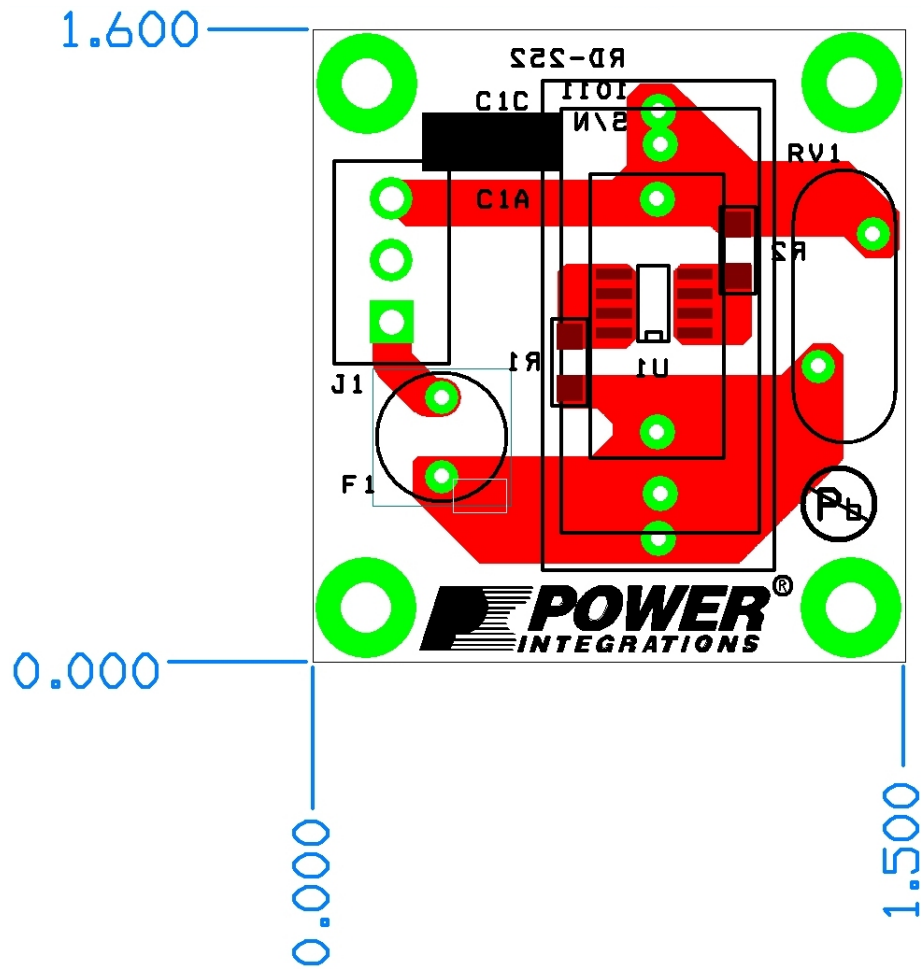

Figure 4 – Printed Circuit Board Layout.



6 Bill of Materials

Item	Qty	Ref Des	Description	Mfg Part Number	Manufacturer
1	1	C1	1 μ F, 275 VAC, Polyester Film, X2	BFC2 338 20105	Vishay BC components
2	1	F1	2 A, 250 V, Slow, TR5	3721200041	Wickman
3	1	J1	3 Position (1 x 3) header, 0.156 pitch, Vertical	26-48-1031	Molex
4	2	R1 R2	390 k Ω , 5%, 1/4 W, Thick Film, 1206	ERJ-8GEYJ394V	Panasonic
5	1	RV1	320 V, 14 mm, RADIAL	S14K320	Littlefuse
6	1	U1	CAPZero, CAP014DG, SO-8	CAP014DG	Power Integrations



7 No-load Input Power Performance

To correctly measuring the no-load input power of the CAPZero device itself the X capacitor and MOV should be removed from the board. The presence of the X capacitor causes reactive currents which flow in the input cables. This results in a real power loss component which is then measured by the AC power meter. Therefore to eliminate this error when measuring the power consumption of the CAPZero IC the capacitor should be removed.

The MOV has a small leakage current which also generates a power loss measured by the power meter so again should be removed to correctly measure the CAPZero consumption.

To illustrate these effects power consumption was measured with and without the capacitor and MOV fitted.

Input Line	MOV and X Capacitor Removed (mW)	MOV Removed (mW)	All Components Present (mW)
85 V / 50 Hz	1.5	1.5	2
100 V / 50 Hz	1.7	1.9	2.8
115 V / 60 Hz	2	2.3	3
132 V / 60 Hz	2.3	2.8	4.8
230 V / 50 Hz	4	5.7	8
240 V / 50 Hz	4.1	6.1	11
265 V / 50 Hz	4.6	7.5	12



7.1 CAPZero IC Consumption (X Capacitor + MOV Removed From Board)

No-load power is measured at room temperature without X capacitor C1B or MOV RV1 fitted. This data represents the true consumption of the CAPZero IC.

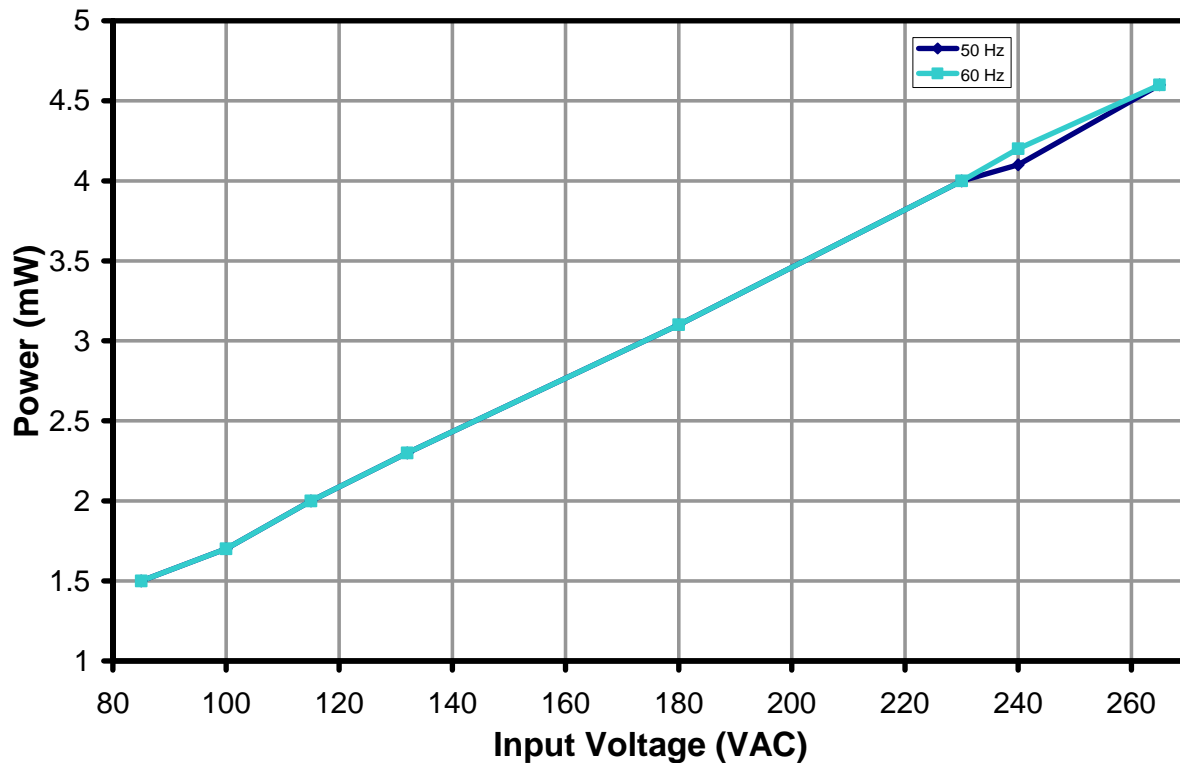

Figure 5 – No-load Input Power vs. Input Line Voltage, Room Temperature, 60 Hz.

Input Line	P_{IN} (mW)
85 V / 50 Hz	1.5
100 V / 50 Hz	1.7
115 V / 60 Hz	2.0
132 V / 60 Hz	2.3
230 V / 50 Hz	4
240 V / 50 Hz	4.1
265 V / 50 Hz	4.6

Table 1 – No-load Input Power vs. Input Voltage with X Capacitor and MOV Removed.



7.2 No-load Consumption Including Effect of X Capacitor and MOV

The following measurements include cable loss as a result of the reactive current drawn by the X capacitor and leakage current of the MOV.

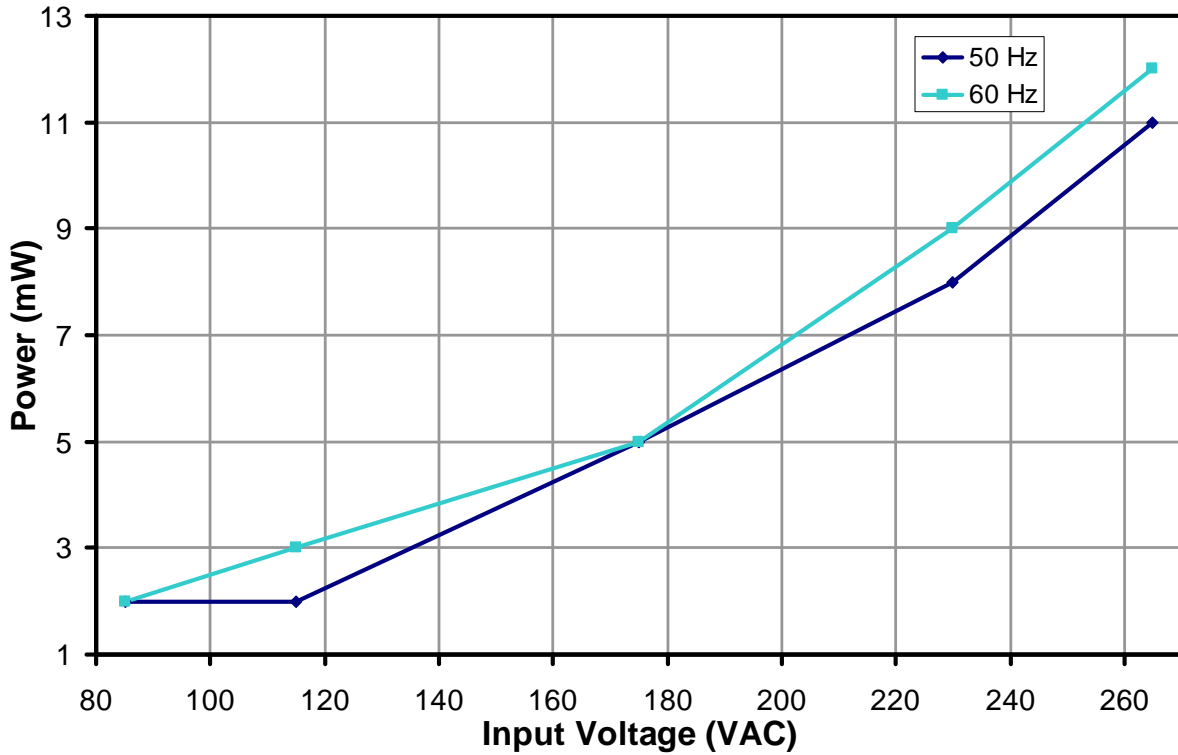

Figure 6 – No-load Input Power with X Capacitor Populated on Board.

Input Line	P _{IN} (mW)
85 V / 50 Hz	2
115 V / 50 Hz	2
175 V / 50 Hz	5
230 V / 50 Hz	8
265 V / 50 Hz	11
85 V / 60 Hz	2
115 V / 60 Hz	3
175 V / 60 Hz	5
230 V / 60 Hz	9
265 V / 60 Hz	12

Table 2 – No-load Input Power vs. Input Voltage Including Effect of X Capacitor and MOV.

7.3 No-load Input Power Including MOV and CAPZero (X Capacitor Removed)

Following measurements are with the X capacitor removed. MOV and CAPZero IC were on the board.

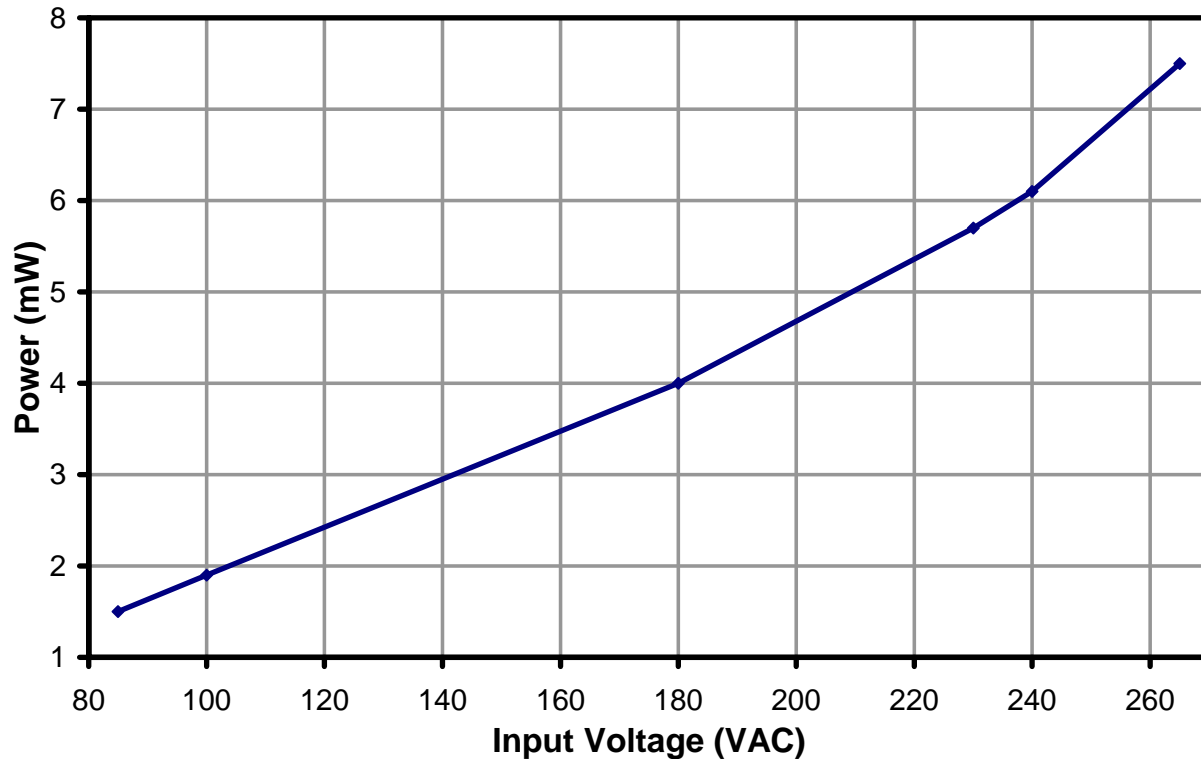

Figure 7 – No-load Input Power vs. Input Line Voltage, Room Temperature, 60 Hz.

Input Line	P_{IN} (mW)
85 V / 50 Hz	1.5
100 V / 50 Hz	1.9
115 V / 60 Hz	2.3
132 V / 60 Hz	2.8
180 V / 50 Hz	4
230 V / 50 Hz	5.7
240 V / 50 Hz	6.1
265 V / 50 Hz	7.5

Table 3 – No-load Input Power vs. Input Voltage Including Effect of MOV Leakage



8 X Capacitor Discharge Waveforms

8.1 AC Disconnect at Room Temperature

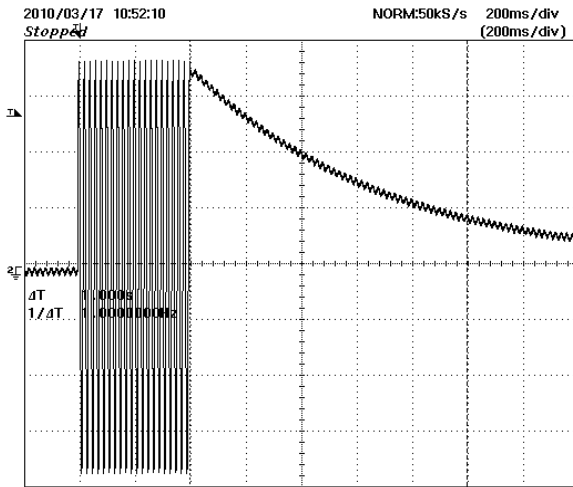

Figure 8 – 265 VAC 50 Hz, No-load.
 V_{IN} , 100 V / div.

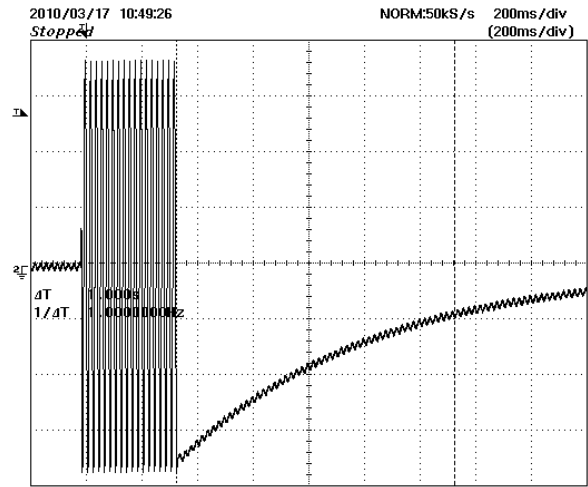

Figure 9 – 265 VAC 50 Hz, No-load.
 V_{IN} , 100 V / div.

8.2 AC Disconnect at 105 °C Ambient

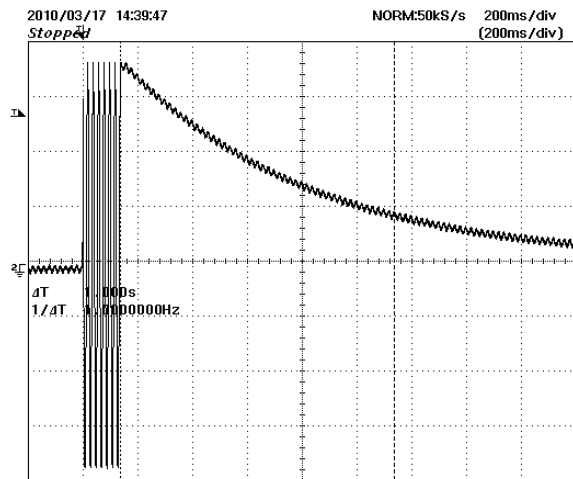

Figure 10 – 265 VAC 50 Hz, No-load.
 V_{IN} , 100 V / div.

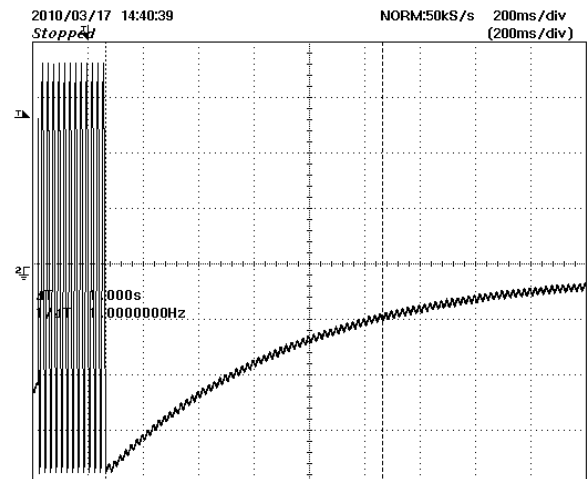

Figure 11 – 265 VAC 50 Hz, No-load.
 V_{IN} , 100 V / div.



8.3 AC Disconnect at -5 °C Ambient

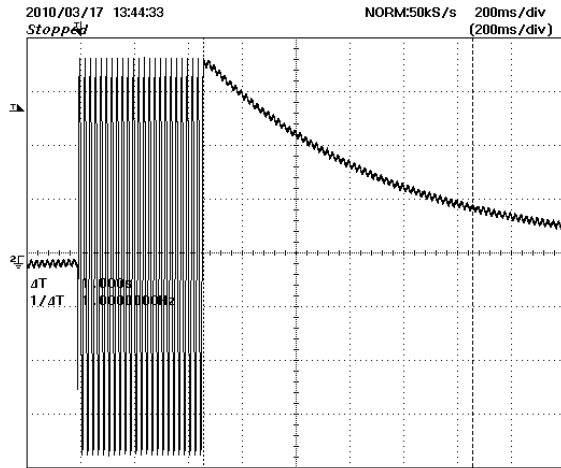

Figure 12 – 265 VAC 50 Hz, No-load.
 V_{IN} , 100 V / div.

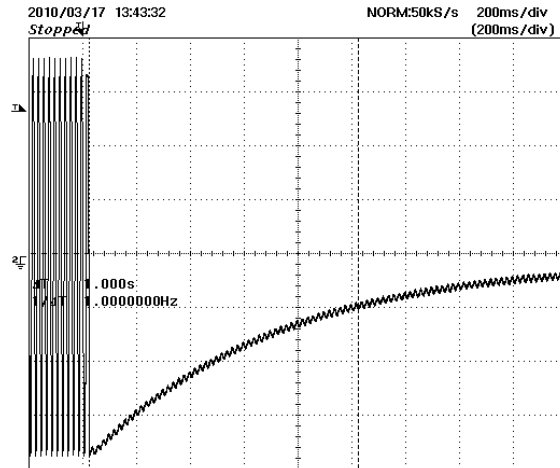

Figure 13 – 265 VAC 50 Hz, No-load.
 V_{IN} , 100 V / div.



8.4 Input Arcing Test Room Temperature

The AC input was connected loosely in a manner so as to generate arcing at the contacts. The test to demonstrate that the CAPZero does not stay “latched-off” due to the arcing event and that it properly detects loss of AC power and safely discharges the X capacitor once the AC is removed.

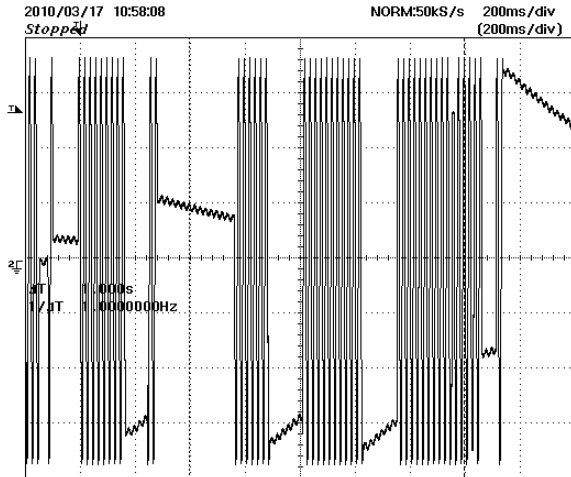

Figure 14 – 265 VAC 50 Hz, No-load.
 V_{IN} , 100 V / div.

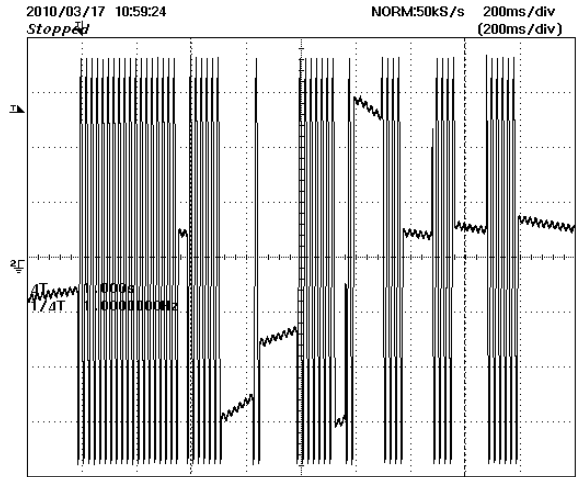

Figure 15 – 265 VAC 50 Hz, No-load.
 V_{IN} , 100 V / div.

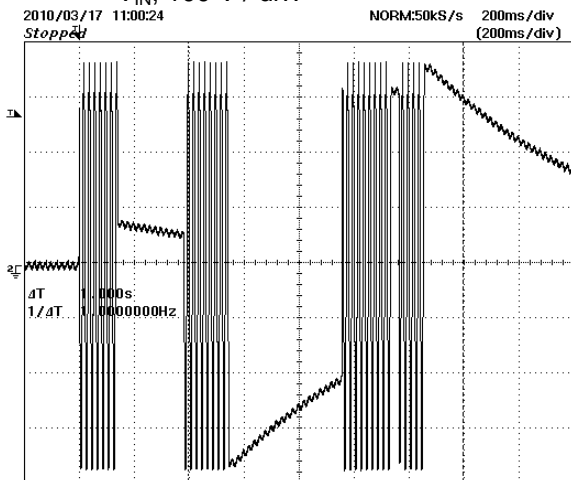

Figure 16 – 265 VAC 50 Hz, No-load.
 V_{IN} , 100 V / div.

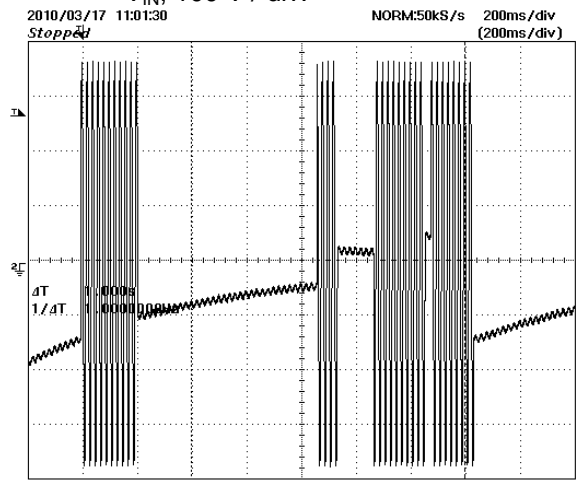

Figure 17 – 265 VAC 50 Hz, No-load.
 V_{IN} , 100 V / div.

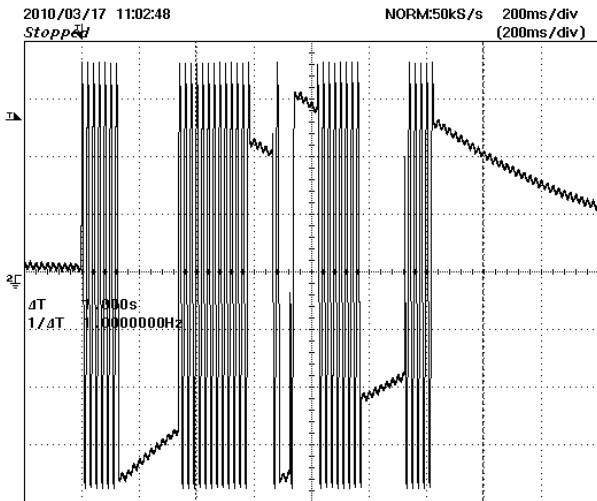

Figure 18 – 265 VAC 50 Hz, No-load.
 V_{IN} , 100 V / div.

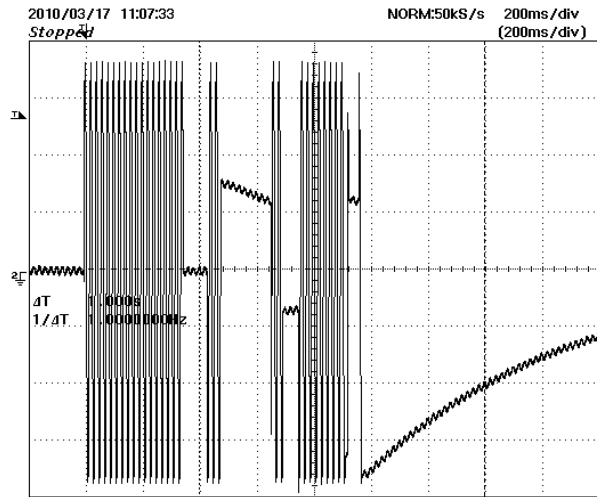

Figure 19 – 265 VAC 50 Hz, No-load.
 V_{IN} , 100 V / div.



8.5 AC Input Arcing Test at 105 °C Ambient

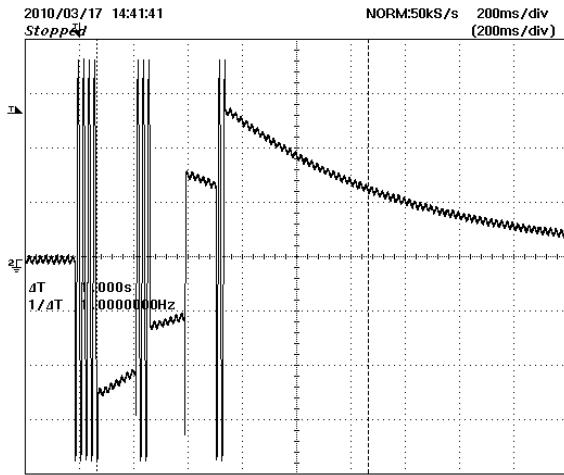

Figure 20 – 265 VAC 50 Hz, No-load.
 V_{IN} , 100 V / div., 200 ms / div.

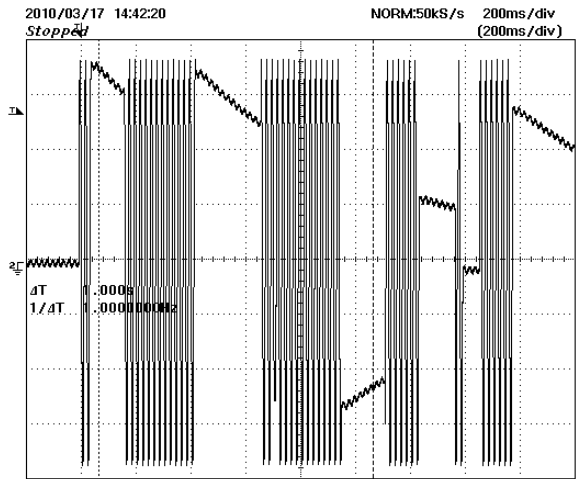

Figure 21 – 265 VAC 50 Hz, No-load.
 V_{IN} , 100 V / div., 200 ms / div.

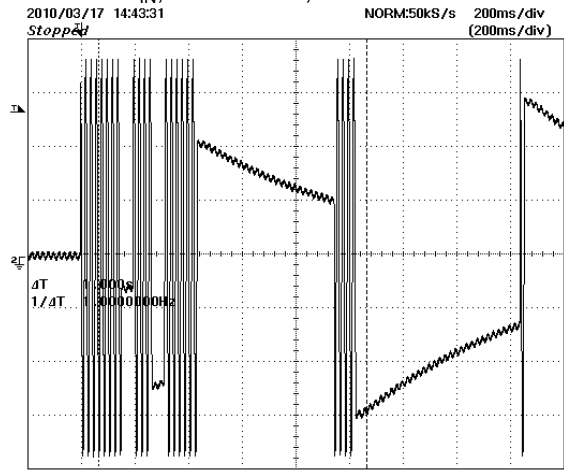

Figure 22 – 265 VAC 50 Hz, No-load.
 V_{IN} , 100 V / div., 200 ms / div.

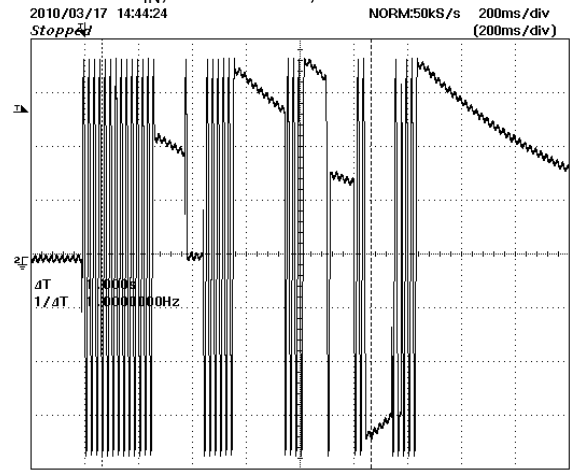

Figure 23 – 265 VAC 50 Hz, No-load.
 V_{IN} , 100 V / div., 200 ms / div.



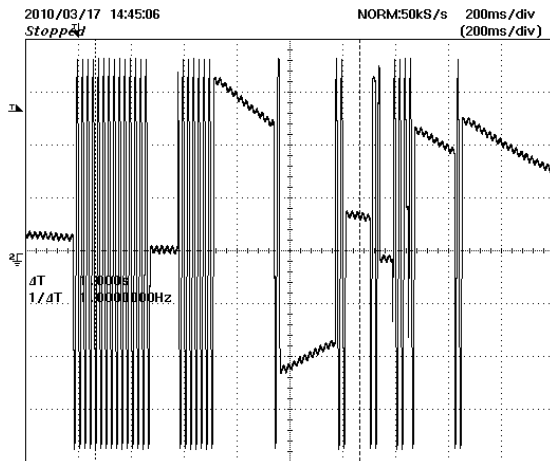

Figure 24 – 265 VAC 50 Hz, No-load.
 V_{IN} Zoom, 100 v / div., 20 ms / div.

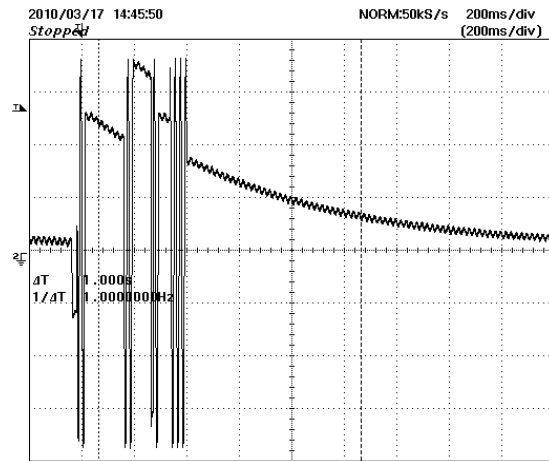

Figure 25 – 265 VAC 50 Hz, No-load.
 V_{IN} , 100 V / div., 200 ms / div.



8.6 AC Input Arcing Test at -5°C Ambient

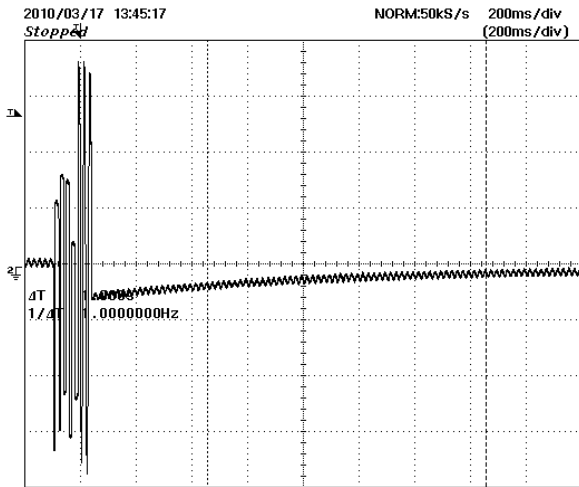

Figure 26 – 265 VAC 50 Hz, No-load.
 V_{IN} , 100 V / div., 200 ms / div.

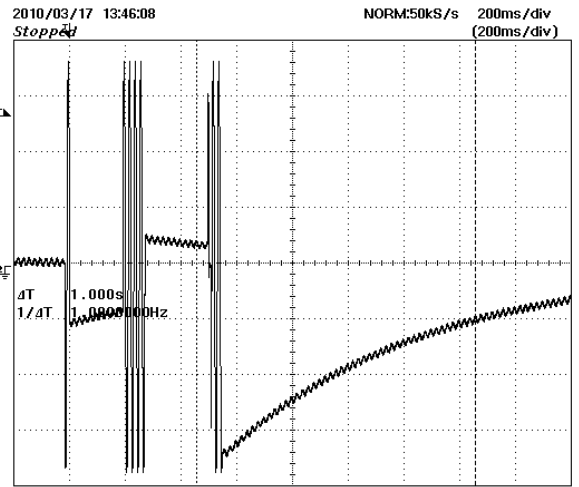

Figure 27 – 265 VAC 50 Hz, No-load.
 V_{IN} , 100 V / div., 200 ms / div.

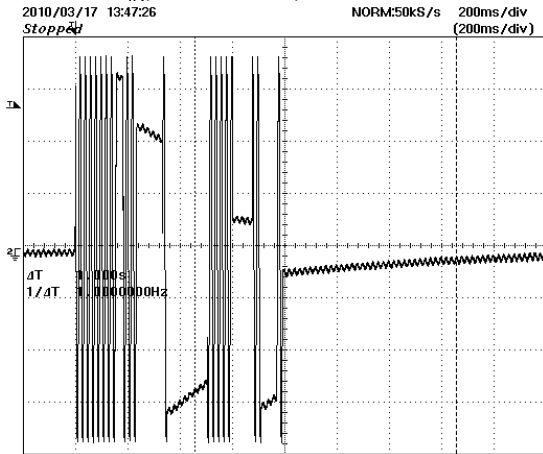

Figure 28 – 265 VAC 50 Hz, No-load.
 V_{IN} , 100 V / div., 200 ms / div.

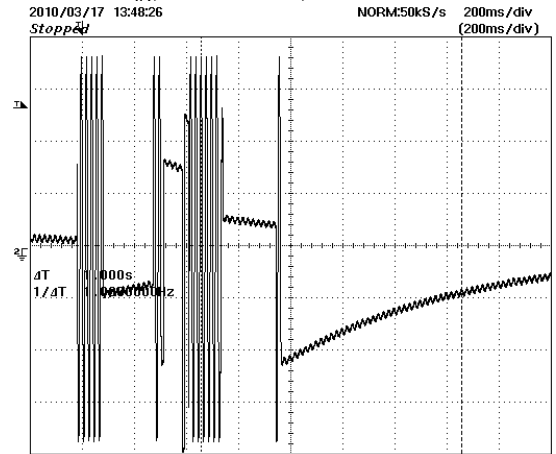

Figure 29 – 265 VAC 50 Hz, No-load.
 V_{IN} , 100 V / div., 200 ms / div.

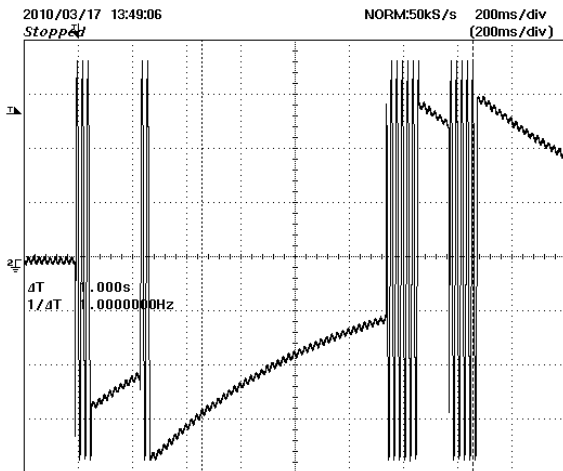

Figure 30 – 265 VAC 50 Hz, No-load.
 V_{IN} , 100 V / div., 200 ms / div.

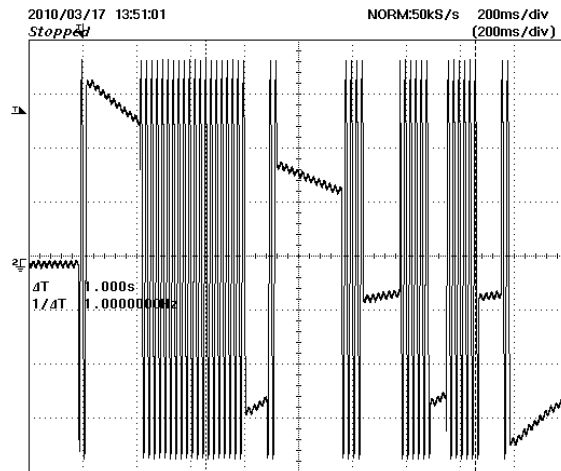

Figure 31 – 265 VAC 50 Hz, No-load.
 V_{IN} , 100 V / div., 200 ms / div.



9 AC Surge and Ring Wave Test

The board was tested at 230 VAC with a 1 μ F capacitor and 2 x 390 k Ω resistors.

9.1 Ring Wave Test

Test Voltage (kV)	Phase Angle (°)	Waveform (A)	Number of Strikes	Test Result
1	90	200	10	PASS
1	270	200	10	PASS

9.2 Differential Mode Surge, 1.2 / 50 μ sec

Surge Voltage (kV)	Phase Angle (°)	Generator Impedance (Ω)	Number of Strikes	Test Result
1.5	90	2	10	PASS
1.5	270	2	10	PASS
2	90	2	10	PASS
2	270	2	10	PASS

9.3 Common Mode Surge, 1.2 / 50 μ sec

Surge Voltage (kV)	Phase Angle (°)	Generator Impedance (Ω)	Number of Strikes	Test Result
4	90	12	10	PASS
4	270	12	10	PASS



9.4 AC Disconnect Test After Surge

Proper operation of CAPZero was verified after 10 strikes of surge test and ring wave test.

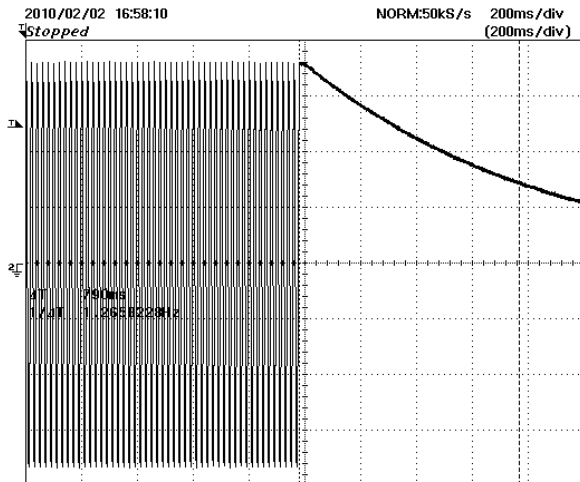

Figure 32 – 265 VAC 50 Hz, No-load.
Upper: V_{IN} , 100 V / div., 200 ms / div.
Lower: V_{IN} Zoom, 100 V / div., 20 ms / div.

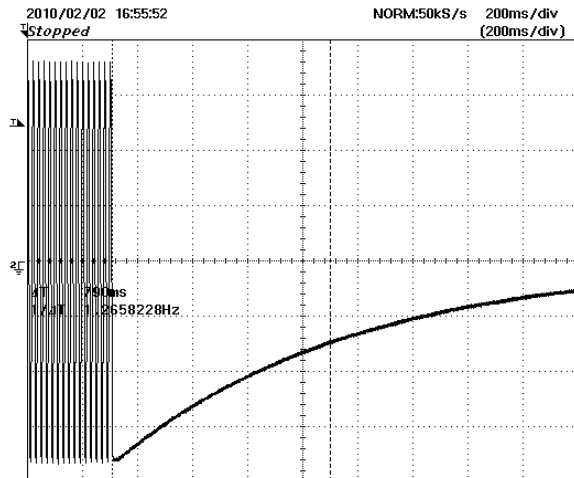

Figure 33 – 265 VAC 50 Hz, No-load.
Upper: V_{IN} , 100 V / div., 200 ms / div.
Lower: V_{IN} Zoom, 100 V / div., 20 ms / div.



10 EMI Tests

EMI performance was tested at no-load with 1 μF capacitors and 2 x 390 k Ω resistors on the board. Comparing results to backgrounds scan it can be seen that CAPZero generates no measurable conducted EMI.

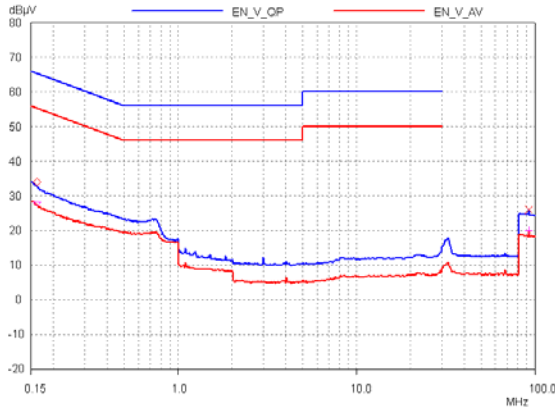

Figure 34 – 115 V Neutral.

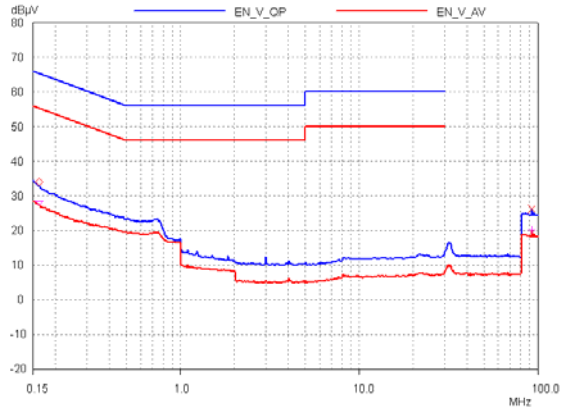

Figure 35 – 115 V Line.

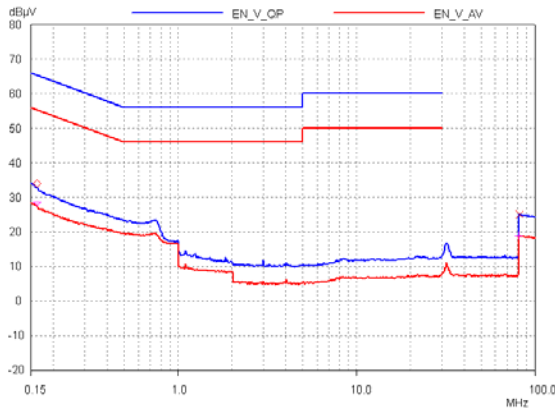

Figure 36 – 230 V Neutral.

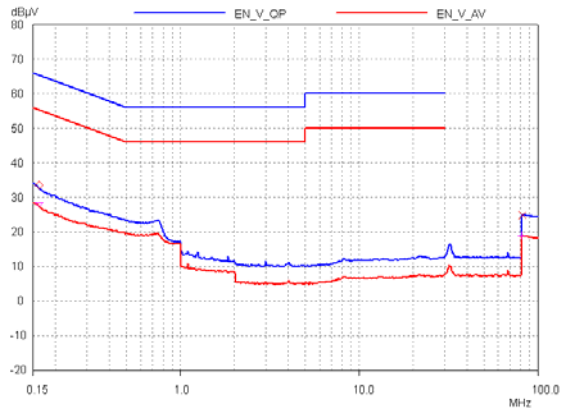

Figure 37 – 230 V Line.

The following EMI scans are done with the unit disconnected to show the background noise level of the test setup.

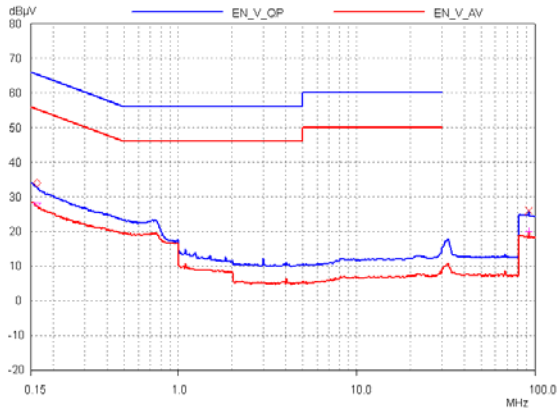

Figure 38 – 115 V Neutral Background Noise.

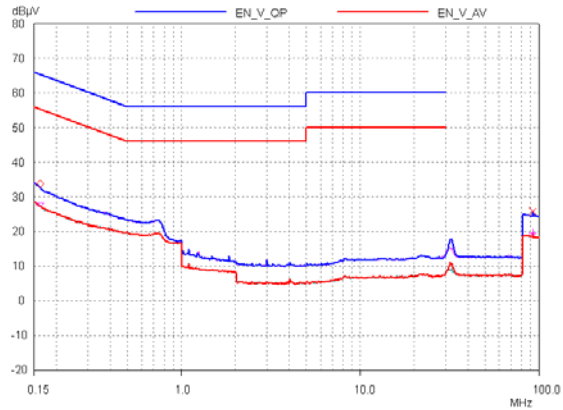

Figure 39 – 115 V Line Background Noise.

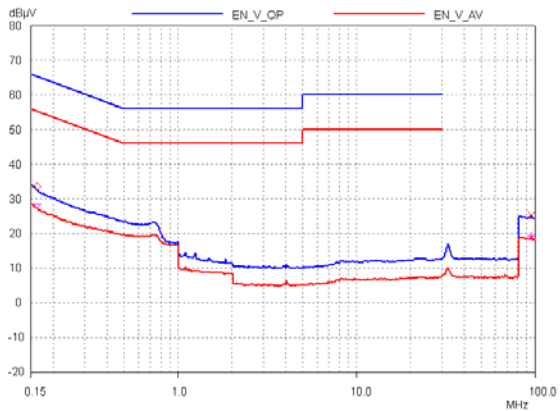

Figure 40 – 230 V Neutral Background Noise.

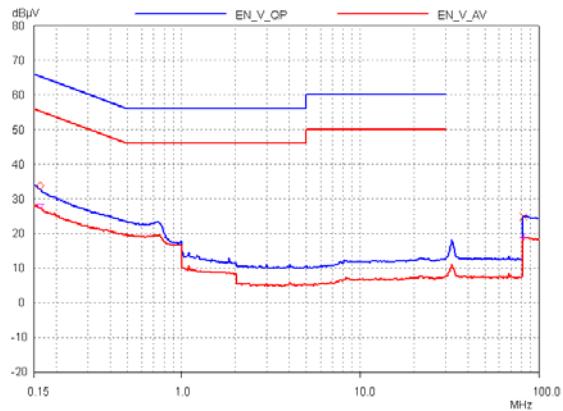

Figure 41 – 230 V Line Background Noise.



11 Revision History

Date	Author	Revision	Description & changes	Reviewed
14-Apr-10	PL	0.6	Initial Release	Apps & Mktg



For the latest updates, visit our website: www.powerint.com

Power Integrations reserves the right to make changes to its products at any time to improve reliability or manufacturability. Power Integrations does not assume any liability arising from the use of any device or circuit described herein. POWER INTEGRATIONS MAKES NO WARRANTY HEREIN AND SPECIFICALLY DISCLAIMS ALL WARRANTIES INCLUDING, WITHOUT LIMITATION, THE IMPLIED WARRANTIES OF MERCHANTABILITY, FITNESS FOR A PARTICULAR PURPOSE, AND NON-INFRINGEMENT OF THIRD PARTY RIGHTS.

PATENT INFORMATION

The products and applications illustrated herein (including transformer construction and circuits external to the products) may be covered by one or more U.S. and foreign patents, or potentially by pending U.S. and foreign patent applications assigned to Power Integrations. A complete list of Power Integrations' patents may be found at www.powerint.com. Power Integrations grants its customers a license under certain patent rights as set forth at <http://www.powerint.com/ip.htm>.

The PI Logo, TOPSwitch, TinySwitch, LinkSwitch, DPA-Switch, PeakSwitch, EcoSmart, Clampless, E-Shield, Filterfuse, StackFET, PI Expert and PI FACTS are trademarks of Power Integrations, Inc. Other trademarks are property of their respective companies. ©Copyright 2010 Power Integrations, Inc.

Power Integrations Worldwide Sales Support Locations

WORLD HEADQUARTERS

5245 Hellyer Avenue
San Jose, CA 95138, USA.
Main: +1-408-414-9200
Customer Service:
Phone: +1-408-414-9665
Fax: +1-408-414-9765
e-mail:
usasales@powerint.com

GERMANY

Rueckertstrasse 3
D-80336, Munich
Germany
Phone: +49-89-5527-3911
Fax: +49-89-5527-3920
e-mail:
eurosales@powerint.com

JAPAN

Kosei Dai-3 Building
2-12-11, Shin-Yokohama,
Kohoku-ku, Yokohama-shi,
Kanagawa 222-0033
Japan
Phone: +81-45-471-1021
Fax: +81-45-471-3717
e-mail: japansales@powerint.com

TAIWAN

5F, No. 318, Nei Hu Rd., Sec. 1
Nei Hu District
Taipei 114, Taiwan R.O.C.
Phone: +886-2-2659-4570
Fax: +886-2-2659-4550
e-mail:
taiwansales@powerint.com

CHINA (SHANGHAI)

Rm 1601/1610, Tower 1
Kerry Everbright City
No. 218 Tianmu Road West
Shanghai, P.R.C. 200070
Phone: +86-021-6354-6323
Fax: +86-021-6354-6325
e-mail:
chinasales@powerint.com

INDIA

#1, 14th Main Road
Vasanthanagar
Bangalore-560052
India
Phone: +91-80-4113-8020
Fax: +91-80-4113-8023
e-mail:
indiasales@powerint.com

KOREA

RM 602, 6FL
Korea City Air Terminal B/D, 159-6
Samsung-Dong, Kangnam-Gu,
Seoul, 135-728
Korea
Phone: +82-2-2016-6610
Fax: +82-2-2016-6630
e-mail: koreasales@powerint.com

UNITED KINGDOM

1st Floor, St. James's House
East Street,
Farnham Surrey, GU9 7TJ
United Kingdom
Phone: +44 (0) 1252-730-141
Fax: +44 (0) 1252-727-689
e-mail:
eurosales@powerint.com

CHINA (SHENZHEN)

Rm A, B & C 4th Floor, Block C,
Electronics Science and
Technology Building
2070 Shennan Zhong Road
Shenzhen, Guangdong,
P.R.C. 518031
Phone: +86-755-8379-3243
Fax: +86-755-8379-5828
e-mail:
chinasales@powerint.com

ITALY

Via De Amicis 2
20091 Bresso MI
Italy
Phone: +39-028-928-6000
Fax: +39-028-928-6009
e-mail:
eurosales@powerint.com

SINGAPORE

51 Newton Road,
#15-08/10 Goldhill Plaza
Singapore, 308900
Phone: +65-6358-2160
Fax: +65-6358-2015
e-mail:
singaporesales@powerint.com

APPLICATIONS HOTLINE

World Wide +1-408-414-9660

APPLICATIONS FAX

World Wide +1-408-414-9760



Power Integrations, Inc.

Tel: +1 408 414 9200 Fax: +1 408 414 9201
www.powerint.com