

ITEM	Q'TY	PART NUMBER	PART DESCRIPTION
1	1	PMS-3	LED Holder, 3-Lead Panel Mount, Press Fit, (5mm)
2	1	5BC-3-XX	T1 ¼ (5mm) 3-Lead Shouldered LED, See Page 2.
3	1	BWS24-1061-GN	24AWG Wire Lead U.L. 1061, Green
4	1	BWS24-1061-BK	24AWG Wire Lead U.L. 1061, Black
5	1	BWS24-1061-RD	24AWG Wire Lead U.L. 1061, Red

REV.	DESCRIPTION	DATE	APPROVED
A	Engineering Release	12/02/08	T. Y.
B	Updated 5BC-3 LED on Polarity Diagram	09/01/09	T. Y.

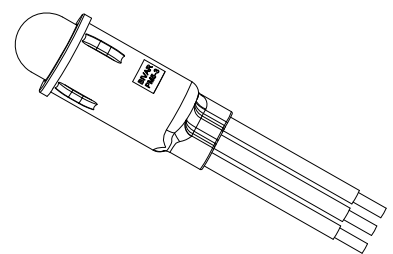
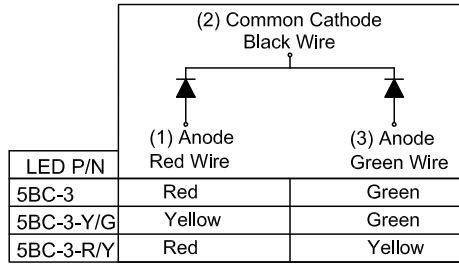
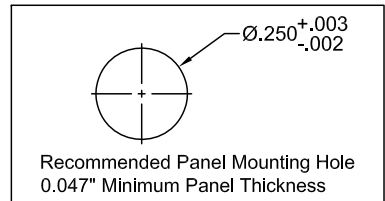
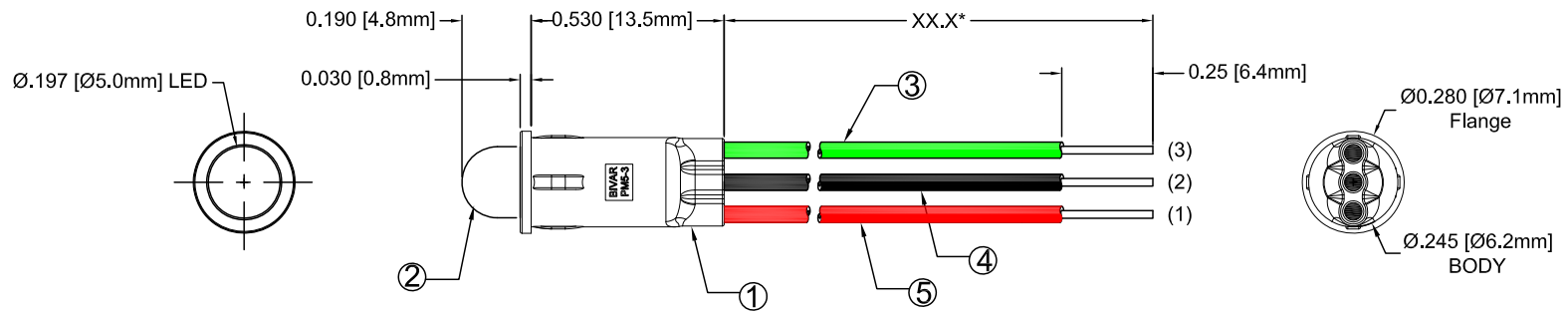

### ABSOLUTE MAXIMUM RATINGS (Ta = 25°C)

- REVERSE VOLTAGE \_\_\_\_\_ 5V
- REVERSE CURRENT ( VR=5V) \_\_\_\_\_ 100µA
- OPERATING TEMPERATURE RANGE \_\_\_\_\_ -25°C ~ 85°C
- STORAGE TEMPERATURE \_\_\_\_\_ -30°C ~ 100°C
- LEAD SOLDERING TEMPERATURE (1/16" FROM BODY) \_\_\_\_\_ 260°C for 5 Seconds



STANDARD TOLERANCE ( UNLESS OTHERWISE SPECIFIED )		 4 THOMAS, IRVINE, CA, 92618 TEL: (949) 951-8808 FAX: (949) 951-3974	
DECIMALS	ANGULAR		
.X ±.1	X° ±1°	 <b>TITLE:</b> T1 ¼ (5mm) PANEL MOUNT ASSEMBLY, 3-LEAD BI-COLOR	<b>REVISION:</b> B
.XX ±.02			
.XXX ±.010		<b>PART NO:</b> PM53-XXWXX.X	<b>SHEET #</b> 1 OF 2
DESIGNED: Brian Oliver	DATE: 12/02/08	<b>CAGE CODE :</b> 32559	
CHECKED: F. Jensen	DATE: 12/02/08	<b>SHEET #</b> 1 OF 2	
CAD GENERATED DOCUMENT. DO NOT MEASURE DRAWING.			

REV.	DESCRIPTION	DATE	APPROVED
	SEE SHEET#1.		

Assembly Part No.	Emitted Colors	LED Part No.
PM53-BCWXX.X	RED/GREEN	5BC-3
PM53-YGWXX.X	YELLOW/GREEN	5BC-3-Y/G
PM53-RYWXX.X	RED/YELLOW	5BC-3-R/Y

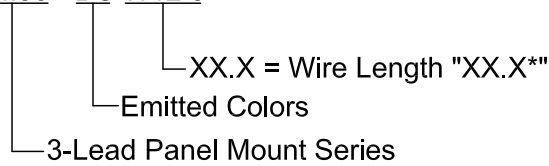
PM53 - BC W12.5



STANDARD TOLERANCE ( UNLESS OTHERWISE SPECIFIED ) ±10% ALL VALUES    ANGULAR		 4 THOMAS, IRVINE, CA, 92618 TEL: (949) 951-8808    FAX: (949) 951-3974	
			<b>TITLE:</b> T-1¼ (5mm) Panel Mount Assembly
DESIGNED: <b>Brian Oliver</b>	DATE: <b>12/02/08</b>	<b>PART NO:</b> PM53-XXWXX.X	REVISION: <b>B</b>
CHECKED: <b>F. Jensen</b>	DATE: <b>12/02/08</b>	<b>CAGE CODE :</b> 32559	<b>SHEET #</b> 2 OF 2
CAD GENERATED DOCUMENT. DO NOT MEASURE DRAWING.			

NOTES:  
1. REFERENCE LED PRINTS FOR OPTICAL/ELECTRICAL SPECIFICATIONS