

PART NUMBER TABLE			
DIM "L"	DIALIGHT PART NUMBER	DIM "L"	DIALIGHT PART NUMBER
10 mm	.....	18 mm	.....
10.5 mm	.....	18.5 mm	.....
11 mm	.....	19 mm	.....
11.5 mm	.....	19.5 mm	515-1142-195F
12 mm	.....	20 mm	.....
12.5 mm	.....	20.5 mm	.....
13 mm	.....	21 mm	.....
13.5 mm	.....	21.5 mm	.....
14 mm	.....	22 mm	.....
14.5 mm	.....	22.5 mm	.....
15 mm	.....	23 mm	.....
15.5 mm	.....	23.5 mm	.....
16 mm	.....	24 mm	.....
16.5 mm	.....	24.5 mm	.....
17 mm	515-1142-170F	25 mm	515-1142-250F
17.5 mm	.....	.....	.....

NOTES:

- LIGHT PIPE TO BE MOLDED IN A CLEAR, TRANSMISSIVE, UL 94-V0 POLYCARBONATE.
- LIGHT PIPE TO BE PRESSED INTO A .062 OR .093 THICK P.C. BOARD.
- LIGHT SOURCE: PLCC-2, PLCC-4 SMT LED OR EQUIVALENT.  
597-3604-307F, BLUE 470nm  
597-3323-307F, GREEN 525nm  
597-3225-307F, YELLOW 590nm  
597-3904-307F, WHITE
- \* DENOTES CRITICAL DIMENSION OR SPECIFICATION.
- VARIABLE LENGTH LIGHT PIPE FROM 10mm MINIMUM TO 25 MAXIMUM. BASIC PART NUMBER IS 515-1142-XXXX  
EXACT LIGHT PIPE PART NUMBER TO BE DETERMINED BY LENGTH IN mm (DIMENSION "L").  
LENGTHS MUST BE IN 0.5mm INCREMENTS. SEE CHART FOR EXACT PART NUMBERS.
- EACH DIFFERENT LENGTH REQUIRES AN ADDITIONAL CORE PIN TOOLING CHARGE.

REV	ECN NO	REVISIONS	DRN	CD	APP	DATE
A		NEW RELEASE	TWC	N.O.	AV	5-11-05
B		REVISED TITLE BLOCK; MOVED DRAWING NUMBER; REPLACED DOMED FEATURE ON OUTPUT SURFACE WITH $\phi .145 \times .010$ FEATURE; CORRECTED NOTES	TWC	TC	NO	6-3-05
C		ADDED "F" SUFFIX TO P/N FOR ROHS COMPLIANT DESIGNATION. REMOVED P/M'S NOT TOOLED.	MES	TWC	N.O.	6-16-06
D		REPLACED $\phi .145 \times .010$ FEATURE WITH ORIGINAL DOMED FEATURE ON OUTPUT SURFACE	TWC			

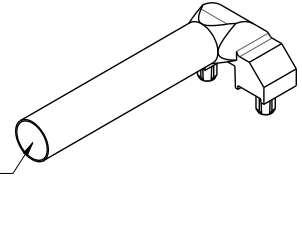
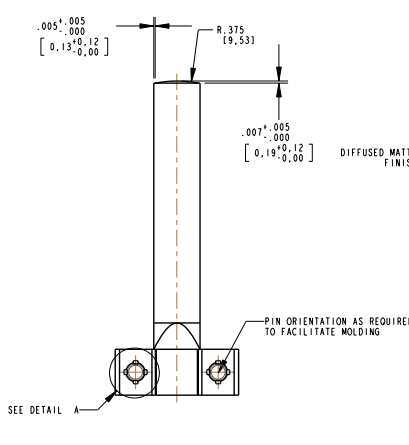
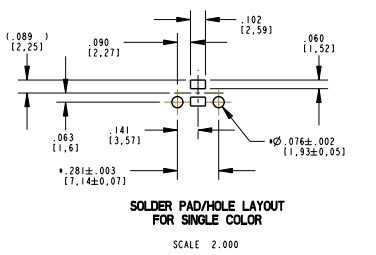
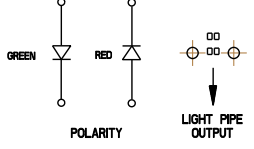
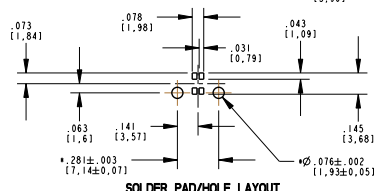
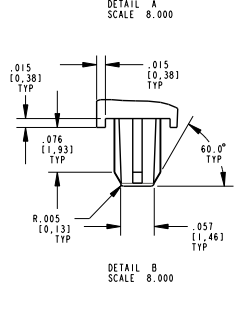
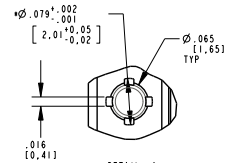
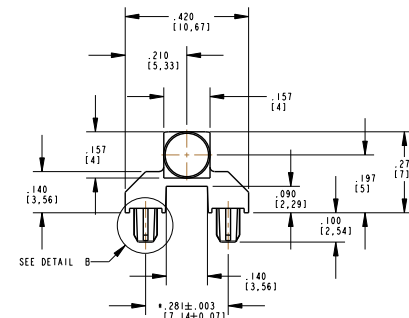
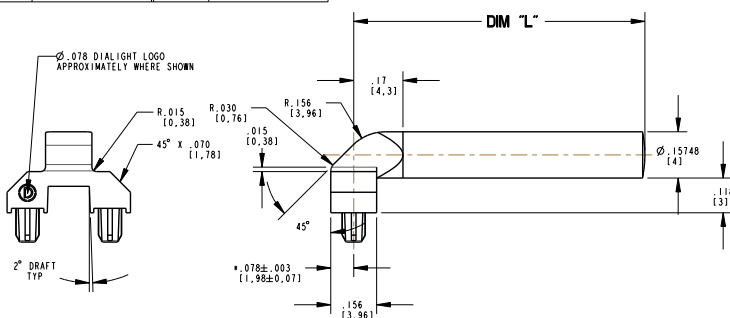

**RoHS Compliant 515-1142-XXXX LIGHTPIPE**  
Part Numbers with the "F" suffix ending are RoHS Compliant.  
Example: 515-1142-170F  
Packaging is marked with "RoHS Compliant" label or equivalent markings.

THIS DRAWING AND THE CONTENTS HEREIN ARE CONFIDENTIAL AND THE SOLE PROPERTY OF DIALIGHT. REPRODUCTION OF THIS DRAWING OR CONSTRUCTION OF ANY PARTS WITHIN THIS DRAWING ARE FORBIDDEN WITHOUT THE WRITTEN CONSENT OF DIALIGHT.	
SCALE: 1:100	DRAWING NUMBER: C-17212
ALL DIM'S IN: INCHES (MM)	REV: D
TOLERANCES: UNLESS OTHERWISE SPECIFIED	PART NUMBER SEE TABLE
FRACTIONS: 1/16 IN	TITLE LIGHTPIPE; ANM DIA, .5MM CL
DECIMALS: 1 DEC: 0.01	ROHS COMPLIANT
DECIMALS: 2 DEC: 0.005	MATERIAL: SEE NOTES
DECIMALS: 3 DEC: 0.0005	FINISH: N/A
ANGLES: .5°	FSCM: 83330
Dialight 1501 ROUTE 34 SOUTH FARMINGDALE, NJ 07727	
SHEET 1 OF 2   FAMILY TABLE:	