

REV	ECN NO	REVISIONS	DRN	CHK	APP	DATE
A	---	NEW RELEASE	TWC	NO	MES	2-2-06
B	---	ADDED ".106±.010" DIMENSION	AJF	KLJ	JLC	11-4-09

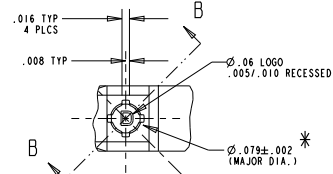

SECTION B-B

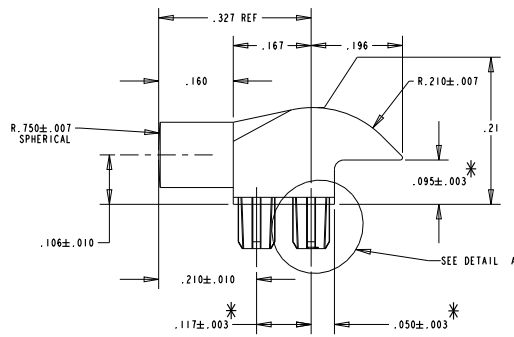
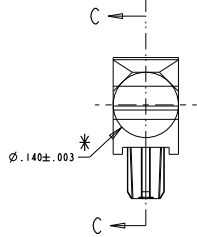
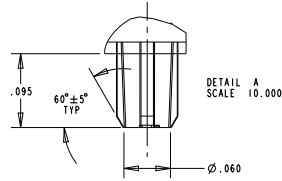
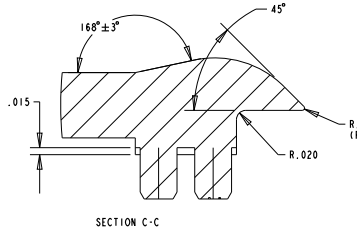
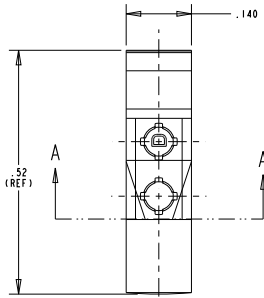
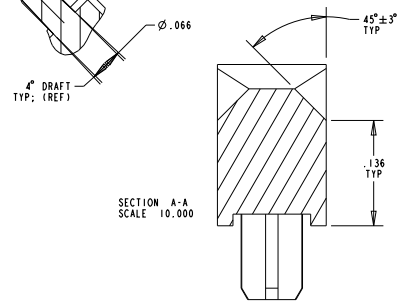

SECTION A-A
SCALE 10.000

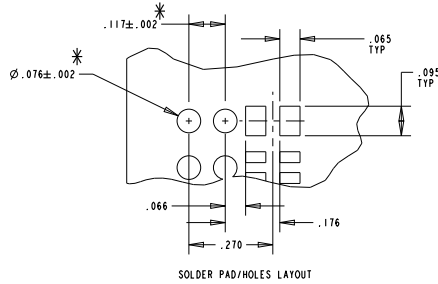
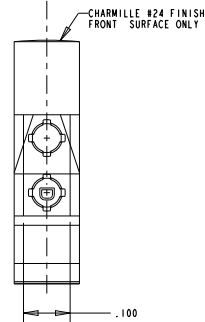

SOLDER PAD/HOLES LAYOUT

RoHS COMPLIANT 515-1049-802F
Part Numbers with the "F" suffix ending are RoHS Compliant.
Packaging is marked with "RoHS Compliant" label or equivalent markings.

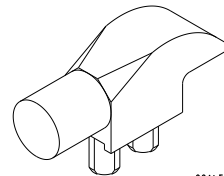

SCALE 6.000

- NOTES:
1. UNLESS OTHERWISE SPECIFIED, ALL SURFACES MUST HAVE FINISH OF SPI A1 TO A2.
 2. UNLESS OTHERWISE SPECIFIED, SINK MARKS & KNOCKOUT MARKS NOT TO EXCEED .003 RECESSED.
 3. FLASH NOT TO EXCEED .005.
 4. NO BUBBLES IN LIGHTPATH GREATER THAN .003.
 5. UNLESS OTHERWISE SPECIFIED, .003 ROUNDS & FILLETS PERMISSIBLE.
 6. UNLESS OTHERWISE SPECIFIED, 2 DEGREE DRAFT PERMISSIBLE.
 7. MATERIAL TO BE CLEAR, TRANSMISSIVE POLYCARBONATE UL-94V-0 OR EQUIVALENT, AS SPECIFIED BY DIALIGHT ENGINEERING DEPT.
 8. * DENOTES CRITICAL DIMENSION OR SPECIFICATION.
 9. DIALIGHT PART NUMBER: 515-1049-802F.

THIS DRAWING AND THE CONTENTS HEREIN ARE CONFIDENTIAL AND THE SOLE PROPERTY OF DIALIGHT. REPRODUCTION OF THIS DRAWING OR CONSTRUCTION OF ANY PARTS WITHIN THIS DRAWING ARE FORBIDDEN WITHOUT THE WRITTEN CONSENT OF DIALIGHT.		
SCALE: 4.000	DRAWING NUMBER	REV
ALL DIM'S IN: INCHES (MM)	C-17358	B
TOLERANCES: UNLESS OTHERWISE SPECIFIED	TITLE SINGLE ELEMENT LIGHTPIPE	
FRACTIONS: ±1/64	RoHS COMPLIANT	
DECIMALS (1.00): ±.01	MATERIAL	
DECIMALS (.1XX): ±.005	Dialight	
ANGLES: ±1°	1501 ROUTE 34 SOUTH	
FINISH:	FARMINGDALE, NJ 07727	
FSCN 83330	SHEET 1 OF 1 FAMILY TABLE	