

## MULTILED

### Enhanced optical Power LED (ThinFilm / ThinGaN)

### Lead (Pb) Free Product - RoHS Compliant

## LTRB GFSF



## Released

### Besondere Merkmale

- **Gehäusertyp:** weißes PLCC-6 Gehäuse mit diffusem Silikon-Verguss
- **Besonderheit des Bauteils:** additive Farbmischung durch unabhängige Ansteuerung aller Chips
- **Wellenlänge:** 632 nm (rot), 523 nm (true green), 465 nm (blau)
- **Abstrahlwinkel:** Lambertscher Strahler (120°)
- **Technologie:** ThinFilm (rot), ThinGaN (true green, blau)
- **optischer Wirkungsgrad:** 45 lm/W @ Cx=0,31; Cy=0,31
- **Gruppierungsparameter:** Lichtstärke, Farbort
  
- **Verarbeitungsmethode:** für alle SMT-Bestücktechniken geeignet
- **Lötmethode:** Reflow Löten
- **Vorbehandlung:** nach JEDEC Level 4
- **Gurtung:** 12 mm Gurt mit 1000/Rolle, ø180 mm
- **ESD-Festigkeit:** ESD-sicher bis 1 kV nach JESD22-A114-D

### Anwendungen

- Anzeigen im Innen- und Außenbereich (z.B. im Verkehrsbereich; Laufschriftanzeigen)
- Getrennte Antsteuerung der Leuchtdiodenchips zur Darstellung verschiedener Farben inklusive weiß
- Hinterleuchtung (LCD, Schalter, Tasten, Werbebeleuchtung, Allgemeinbeleuchtung)
- Einkopplung in Lichtleiter
- Beleuchtung im Automobilbereich (z.B. Instrumentenbeleuchtung)

### Features

- **package:** white PLCC-6 package with diffused silicone resin
- **feature of the device:** well defined white color groups with RGB-LED
  
- **wavelength:** 632 nm (red), 523 nm (true green), 465 nm (blue)
- **viewing angle:** Lambertian Emitter (120°)
- **technology:** ThinFilm (red), ThinGaN (true green, blue)
- **optical efficiency:** 45 lm/W @ Cx=0.31; Cy=0.31
- **grouping parameter:** luminous intensity, color coordinates
- **assembly methods:** suitable for all SMT assembly methods
- **soldering methods:** reflow soldering
- **preconditioning:** acc. to JEDEC Level 4
- **taping:** 12 mm tape with 1000/reel, ø180 mm
- **ESD-withstand voltage:** up to 1 kV acc. to JESD22-A114-D

### Applications

- indoor and outdoor displays (e.g. displays for traffic; light writing displays)
- LED chips can be controlled separately to display various colors including white
- backlighting (LCD, switches, keys, illuminated advertising, general lighting)
- coupling into light guides
- automotive lighting (e.g. dashboard backlighting)

**Bestellinformation**  
**Ordering Information**

Typ Type	Emissionsfarbe Color of Emission	Lichtstärke <sup>1)</sup> Seite 27 Luminous Intensity <sup>1)</sup> page 27 I <sub>v</sub> (mcd)		
		white		
LTRB GFSF-ABCB-QKYO	true green (20mA) red (20mA) blue (10mA)	1.400...4.500		
		red	true green	blue
	I <sub>v</sub> (typ) @20mA (T,R); (10mA (B)	700	1350	160

**Bestellinformation**  
**Ordering Information**

Typ Type	Bestellnummer Ordering Code
LTRB GFSF-ABCB-QKYO	Q65110A9484

Anm.: Die oben genannten Typbezeichnungen umfassen die bestellbaren Selektionen. Diese bestehen aus wenigen Helligkeitsgruppen (siehe **Seite 9** für nähere Informationen). Es wird nur eine einzige Helligkeitsgruppe pro Gurt geliefert. Z.B.: LTRB GFSF-**ABCB**-QKYO bedeutet, dass auf dem Gurt nur eine der Helligkeitsgruppen AB, BA, BB, CA oder CB enthalten ist.  
Um die Liefersicherheit zu gewährleisten, können einzelne Helligkeitsgruppen nicht bestellt werden.

Gleiches gilt für die Farben, bei denen Farbortgruppen gemessen und gruppiert werden. Pro Gurt wird nur eine Farbortgruppe geliefert. Z.B.: LTRB GFSF-**ABCB-QKYO** bedeutet, dass auf dem Gurt nur eine der Farbortgruppen -QK bis -YO enthalten ist (siehe **Seite 5** für nähere Information).  
Um die Liefersicherheit zu gewährleisten, können einzelne Farbortgruppen nicht bestellt werden.

Note: The above Type Numbers represent the order groups which include only a few brightness groups (see **page 9** for explanation). Only one group will be shipped on each reel (there will be no mixing of two groups on each reel). E.g. LTRB GFSF-**ABCB**-QKYO means that only one group AB, BA, BB, CA or CB will be shippable for any one reel.  
In order to ensure availability, single brightness groups will not be orderable.

In a similar manner for colors where chromaticity coordinate groups are measured and binned, single chromaticity coordinate groups will be shipped on any one reel. E.g. LTRB GFSF-**ABCB-QKYO** means that only 1 chromaticity coordinate group -QK to -YO will be shippable on each reel (see **page 5** for explanation).  
In order to ensure availability, single chromaticity coordinate groups will not be orderable..

**Grenzwerte**  
**Maximum Ratings**

Bezeichnung Parameter	Symbol Symbol	Werte Values			Einheit Unit
		red	true green	blue	
Betriebstemperatur Operating temperature range	$T_{op}$	- 40 ... + 100			°C
Lagertemperatur Storage temperature range	$T_{stg}$	- 40 ... + 100			°C
Sperrschichttemperatur Junction temperature	$T_j$	+ 125			°C
Durchlassstrom (min.) Forward current (max.) ( $T_S=25^\circ\text{C}$ )	$I_F$	- 40	5 50		mA
Stoßstrom Surge current $t_p = 10 \mu\text{s}$ , $D = 0.005$ , $T_S=25^\circ\text{C}$	$I_{FM}$	100	300		mA
Sperrspannung <sup>2) Seite 27</sup> Reverse voltage <sup>2) page 27</sup> ( $T_S=25^\circ\text{C}$ )	$V_R$	12	5		V

**Kennwerte**  
**Characteristics**
 $(T_S = 25\text{ °C})$ 

Bezeichnung Parameter	Symbol Symbol	Werte Values			Einheit Unit
		red	true green	blue	
Wellenlänge des emittierten Lichtes Wavelength at peak emission $I_F = 20\text{ mA}$	(typ.) $\lambda_{\text{peak}}$	632	523	465	nm
Dominantwellenlänge <sup>4)</sup> Seite 27 Dominant wavelength <sup>4)</sup> page 27 $I_F = 20\text{ mA}$	(min.) $\lambda_{\text{dom}}$ (typ.) (max.)	619 625 631	519 530 540	457 460 470	nm nm nm
Spektrale Bandbreite bei 50 % $I_{\text{rel max}}$ Spectral bandwidth at 50 % $I_{\text{rel max}}$ $I_F = 20\text{ mA}$	(typ.) $\Delta\lambda$	18	33	25	nm
Abstrahlwinkel bei 50 % $I_V$ (Vollwinkel) Viewing angle at 50 % $I_V$	(typ.) $2\phi$	120			Grad deg.
Durchlassspannung <sup>5)</sup> Seite 27 Forward voltage <sup>5)</sup> page 27 $I_F = 20\text{ mA}$	(min.) $V_F$ (typ.) $V_F$ (max.) $V_F$	1.8 2.05 2.4	2.9 3.2 3.7		V V V
Sperrstrom Reverse current $V_R = 5\text{ V}$ (blue / true green); 12 V (red)	(typ.) $I_R$ (max.) $I_R$	0.02 10	0.01 10		$\mu\text{A}$ $\mu\text{A}$
Wärmewiderstand Thermal resistance Sperrschicht/Umgebung <sup>3)</sup> Seite 27 Junction/ambient <sup>3)</sup> page 27 Sperrschicht/Löt看 Junction/solder point	1 chip on (typ.) $R_{\text{th JA}}$ 3 chips on (typ.) $R_{\text{th JA}}$ (max.) $R_{\text{th JS}}$	440** 700 280**	340** 600 180**		K/W K/W K/W

\* Einzelgruppen siehe Seite 8  
Individual groups on page 8

\*\* $R_{\text{th(max)}}$  basiert auf statistischen Werten  
 $R_{\text{th(max)}}$  is based on statistic values

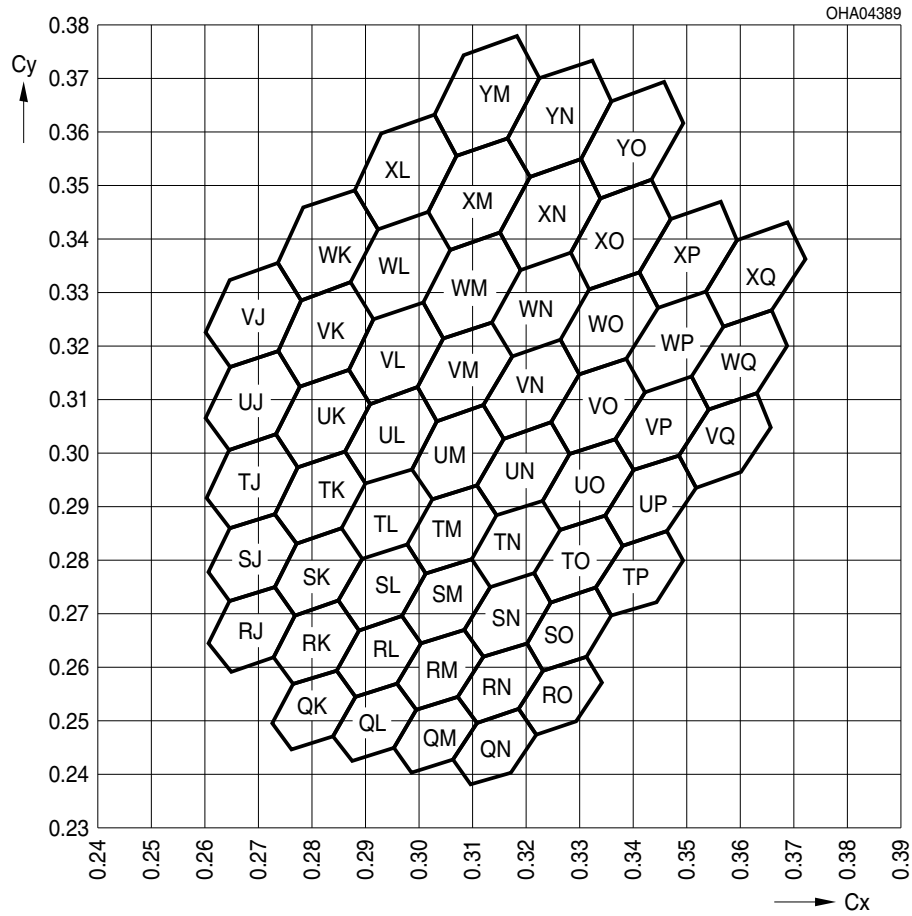

Gruppe Group	Cx	Cy
QK	0,2845	0,2592
	0,2882	0,2543
	0,2841	0,2470
	0,2764	0,2446
	0,2726	0,2494
	0,2766	0,2567
QL	0,2961	0,2568
	0,2996	0,2519
	0,2953	0,2447
	0,2877	0,2423
	0,2841	0,2470
	0,2882	0,2543

Gruppe Group	Cx	Cy
TN	0,3230	0,2910
	0,3264	0,2854
	0,3214	0,2773
	0,3132	0,2747
	0,3097	0,2800
	0,3145	0,2883
	0,3109	0,2940
TM	0,3145	0,2883
	0,3097	0,2800
	0,3014	0,2774
	0,2977	0,2828
	0,3024	0,2912

Gruppe Group	Cx	Cy
VK	0,2873	0,3316
	0,2915	0,3249
	0,2867	0,3154
	0,2778	0,3124
	0,2735	0,3188
	0,2781	0,3285
VJ	0,2737	0,3354
	0,2781	0,3285
	0,2735	0,3188
	0,2645	0,3158
	0,2600	0,3223
	0,2645	0,3322

Gruppe Group	Cx	Cy	Gruppe Group	Cx	Cy	Gruppe Group	Cx	Cy
QM	0.3074	0.2543	TL	0.2986	0.2970	WK	0.2879	0.3489
	0.3108	0.2495		0.3024	0.2912		0.2923	0.3418
	0.3064	0.2425		0.2977	0.2828		0.2873	0.3316
	0.2988	0.2401		0.2894	0.2802		0.2781	0.3285
	0.2953	0.2447		0.2856	0.2857		0.2737	0.3354
	0.2996	0.2519		0.2901	0.2942		0.2785	0.3457
QN	0.3186	0.2520	TK	0.2861	0.3001	WL	0.3017	0.3450
	0.3218	0.2472		0.2901	0.2942		0.3058	0.3379
	0.3172	0.2403		0.2856	0.2857		0.3006	0.3280
	0.3097	0.2379		0.2772	0.2830		0.2915	0.3249
	0.3064	0.2425		0.2731	0.2886		0.2873	0.3316
	0.3108	0.2495		0.2775	0.2973		0.2923	0.3418
RO	0.3312	0.2618	TJ	0.2733	0.3033	WM	0.3151	0.3411
	0.3342	0.2569		0.2775	0.2973		0.3189	0.3342
	0.3295	0.2496		0.2731	0.2886		0.3136	0.3244
	0.3218	0.2472		0.2647	0.2859		0.3046	0.3214
	0.3186	0.2520		0.2604	0.2916		0.3006	0.3280
	0.3232	0.2593		0.2646	0.3004		0.3058	0.3379
RN	0.3200	0.2643	UJ	0.2735	0.3188	WN	0.3282	0.3373
	0.3232	0.2593		0.2778	0.3124		0.3318	0.3306
	0.3186	0.2520		0.2733	0.3033		0.3264	0.3210
	0.3108	0.2495		0.2646	0.3004		0.3174	0.3180
	0.3074	0.2543		0.2602	0.3065		0.3136	0.3244
	0.3120	0.2618		0.2645	0.3158		0.3189	0.3342
RM	0.3085	0.2668	UK	0.2867	0.3154	WO	0.3410	0.3336
	0.3120	0.2618		0.2908	0.3091		0.3445	0.3270
	0.3074	0.2543		0.2861	0.3001		0.3388	0.3176
	0.2996	0.2519		0.2775	0.2973		0.3299	0.3146
	0.2961	0.2568		0.2733	0.3033		0.3264	0.3210
	0.3005	0.2643		0.2778	0.3124		0.3318	0.3306
RL	0.2969	0.2694	UL	0.2996	0.3121	WP	0.3536	0.3300
	0.3005	0.2643		0.3035	0.3059		0.3568	0.3235
	0.2961	0.2568		0.2986	0.2970		0.3510	0.3142
	0.2882	0.2543		0.2901	0.2942		0.3422	0.3113
	0.2845	0.2592		0.2861	0.3001		0.3388	0.3176
	0.2888	0.2669		0.2908	0.3091		0.3445	0.3270

Gruppe Group	Cx	Cy	Gruppe Group	Cx	Cy	Gruppe Group	Cx	Cy
RK	0.2850	0.2721	UM	0.3122	0.3088	WQ	0.3659	0.3265
	0.2888	0.2669		0.3159	0.3027		0.3689	0.3201
	0.2845	0.2592		0.3109	0.2940		0.3630	0.3109
	0.2766	0.2567		0.3024	0.2912		0.3542	0.3081
	0.2728	0.2617		0.2986	0.2970		0.3510	0.3142
	0.2769	0.2695		0.3035	0.3059		0.3568	0.3235
RJ	0.2729	0.2748	UN	0.3246	0.3055	XQ	0.3689	0.3430
	0.2769	0.2695		0.3281	0.2996		0.3720	0.3362
	0.2728	0.2617		0.3230	0.2910		0.3659	0.3265
	0.2648	0.2592		0.3145	0.2883		0.3568	0.3235
	0.2608	0.2643		0.3109	0.2940		0.3536	0.3300
	0.2647	0.2722		0.3159	0.3027		0.3596	0.3399
SJ	0.2731	0.2886	UO	0.3367	0.3024	XP	0.3563	0.3468
	0.2772	0.2830		0.3400	0.2965		0.3596	0.3399
	0.2729	0.2748		0.3348	0.2881		0.3536	0.3300
	0.2647	0.2722		0.3264	0.2854		0.3445	0.3270
	0.2606	0.2776		0.3230	0.2910		0.3410	0.3336
	0.2647	0.2859		0.3281	0.2996		0.3469	0.3437
SK	0.2856	0.2857	UP	0.3486	0.2993	XO	0.3434	0.3508
	0.2894	0.2802		0.3517	0.2935		0.3469	0.3437
	0.2850	0.2721		0.3463	0.2852		0.3410	0.3336
	0.2769	0.2695		0.3380	0.2826		0.3318	0.3306
	0.2729	0.2748		0.3348	0.2881		0.3282	0.3373
	0.2772	0.2830		0.3400	0.2965		0.3339	0.3475
SL	0.2977	0.2828	VQ	0.3630	0.3109	XN	0.3302	0.3548
	0.3014	0.2774		0.3659	0.3049		0.3339	0.3475
	0.2969	0.2694		0.3602	0.2963		0.3282	0.3373
	0.2888	0.2669		0.3517	0.2935		0.3189	0.3342
	0.2850	0.2721		0.3486	0.2993		0.3151	0.3411
	0.2894	0.2802		0.3542	0.3081		0.3206	0.3515
SM	0.3097	0.2800	VP	0.3510	0.3142	XM	0.3166	0.3589
	0.3132	0.2747		0.3542	0.3081		0.3206	0.3515
	0.3085	0.2668		0.3486	0.2993		0.3151	0.3411
	0.3005	0.2643		0.3400	0.2965		0.3058	0.3379
	0.2969	0.2694		0.3367	0.3024		0.3017	0.3450
	0.3014	0.2774		0.3422	0.3113		0.3070	0.3555

Gruppe Group	Cx	Cy	Gruppe Group	Cx	Cy	Gruppe Group	Cx	Cy
SN	0.3214	0.2773	VO	0.3388	0.3176	XL	0.3028	0.3631
	0.3247	0.2720		0.3422	0.3113		0.3070	0.3555
	0.3200	0.2643		0.3367	0.3024		0.3017	0.3450
	0.3120	0.2618		0.3281	0.2996		0.2923	0.3418
	0.3085	0.2668		0.3246	0.3055		0.2879	0.3489
	0.3132	0.2747		0.3299	0.3146		0.2931	0.3597
SO	0.3329	0.2746	VN	0.3264	0.3210	YM	0.3183	0.3778
	0.3361	0.2694		0.3299	0.3146		0.3224	0.3699
	0.3312	0.2618		0.3246	0.3055		0.3166	0.3589
	0.3232	0.2593		0.3159	0.3027		0.3070	0.3555
	0.3200	0.2643		0.3122	0.3088		0.3028	0.3631
	0.3247	0.2720		0.3174	0.3180		0.3084	0.3743
TP	0.3463	0.2852	VM	0.3136	0.3244	YN	0.3323	0.3733
	0.3494	0.2798		0.3174	0.3180		0.3361	0.3656
	0.3442	0.2719		0.3122	0.3088		0.3302	0.3548
	0.3361	0.2694		0.3035	0.3059		0.3206	0.3515
	0.3329	0.2746		0.2996	0.3121		0.3166	0.3589
	0.3380	0.2826		0.3046	0.3214		0.3224	0.3699
TO	0.3348	0.2881	VL	0.3006	0.3280	YO	0.3459	0.3690
	0.3380	0.2826		0.3046	0.3214		0.3495	0.3614
	0.3329	0.2746		0.2996	0.3121		0.3434	0.3508
	0.3247	0.2720		0.2908	0.3091		0.3339	0.3475
	0.3214	0.2773		0.2867	0.3154		0.3302	0.3548
	0.3264	0.2854		0.2915	0.3249		0.3361	0.3656

Anm.: Die Farbkordinaten des Mischlichtes können innerhalb des gekennzeichneten Bereichs des Farbdreiecks erwartet werden.

Note: The color coordinates of the mixed light can be expected within the marked area of the color triangle



### Helligkeits-Gruppierungsschema Brightness Groups

Helligkeitsgruppe Brightness Group	Lichtstärke <sup>2)</sup> Seite 19 Luminous Intensity <sup>2)</sup> page 19 I <sub>v</sub> (mcd)
AB	1.400 ...1.800
BA	1.800 ...2.240
BB	2.240 ...2.800
CA	2.800 ...3.550
CB	3.550 ...4.500

*Anm.: Die Standardlieferform von Serientypen beinhaltet eine Familiengruppe. Diese besteht aus 5 Helligkeitsgruppen. Einzelne Helligkeitsgruppen sind nicht bestellbar.*

*Note: The standard shipping format for serial types includes a family group of 5 individual brightness groups. Individual brightness groups cannot be ordered.*

### Gruppenbezeichnung auf Etikett Group Name on Label

Beispiel: BA-QK  
Example: BA-QK

Helligkeitsgruppe Brightness Group	Farbortgruppe Color coordinates
BA	QK

*Anm.: In einer Verpackungseinheit / Gurt ist immer nur eine Helligkeitsgruppe pro Farbe enthalten.*

*Note: No packing unit / tape ever contains more than one brightness group per color.*

Relative spektrale Emission<sup>6)</sup> Seite 27

Relative Spectral Emission<sup>6)</sup> page 27

$V(\lambda)$  = spektrale Augenempfindlichkeit / Standard eye response curve

$I_{rel} = f(\lambda)$ ;  $T_S = 25\text{ }^\circ\text{C}$ ;  $I_F = 20\text{ mA}$

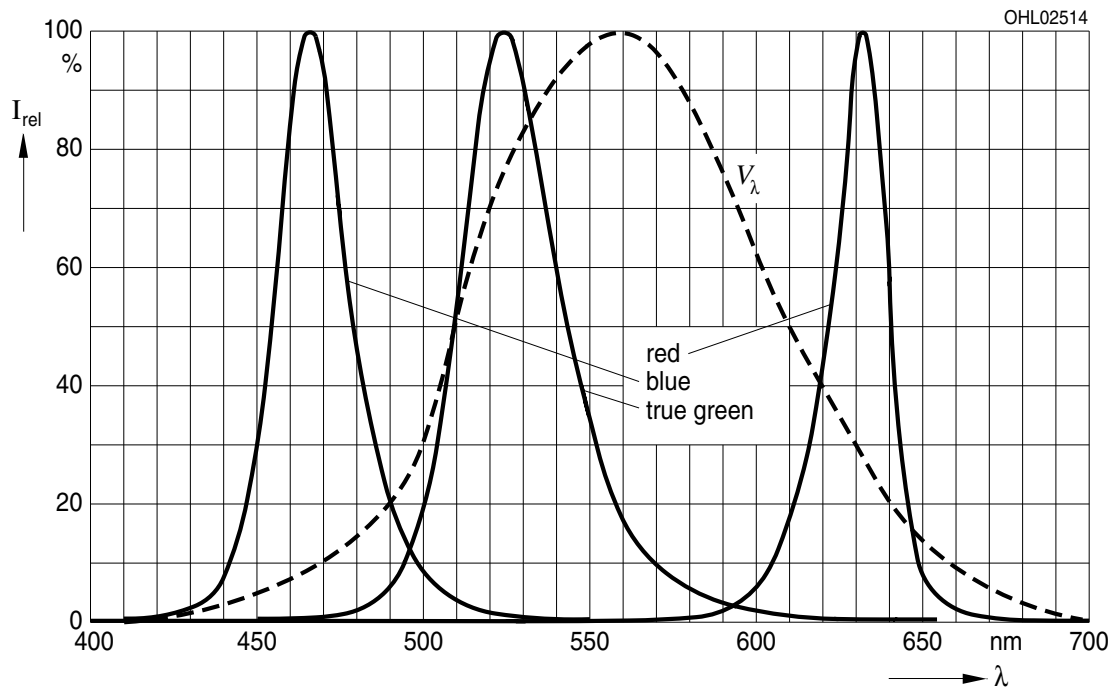

**Abstrahlcharakteristik**<sup>6)</sup> Seite 27  
**Radiation Characteristic**<sup>6)</sup> page 27

$I_{rel} = f(\varphi)$ ;  $T_S = 25\text{ °C}$ ,  $I_F = 20\text{ mA}$  (T); 20 mA (R); 10 mA (B) true green, red, blue

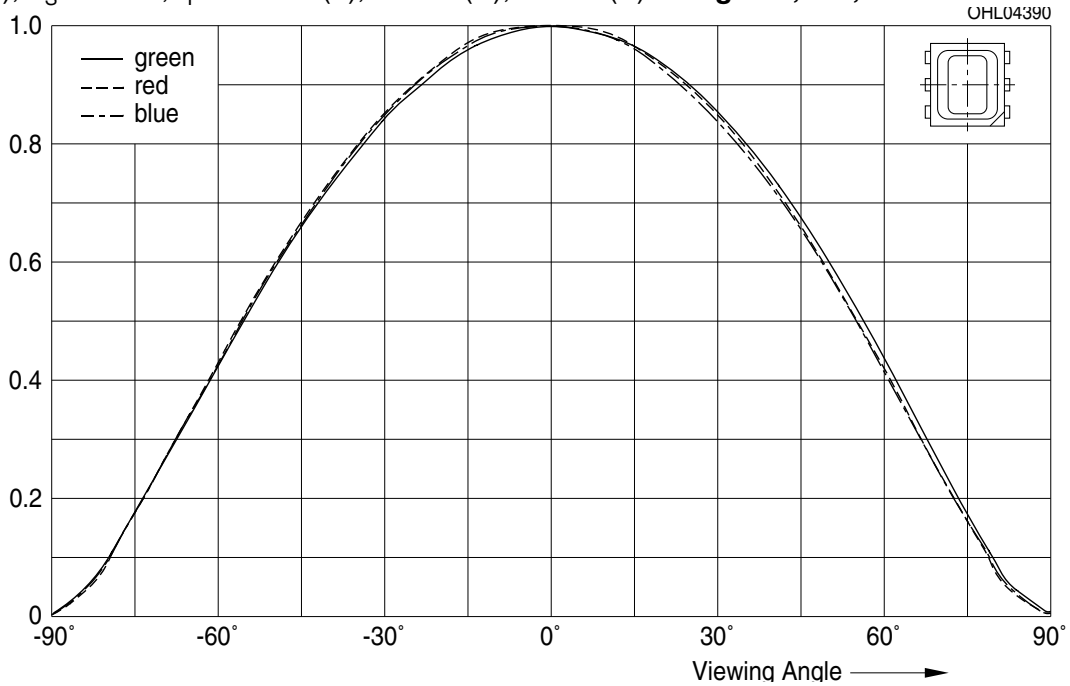

**Abstrahlcharakteristik**<sup>6)</sup> Seite 27  
**Radiation Characteristic**<sup>6)</sup> page 27

$I_{rel} = f(\varphi)$ ;  $T_S = 25\text{ °C}$ ,  $I_F = 20\text{ mA}$  (T); 20 mA (R); 10 mA (B) true green, red, blue

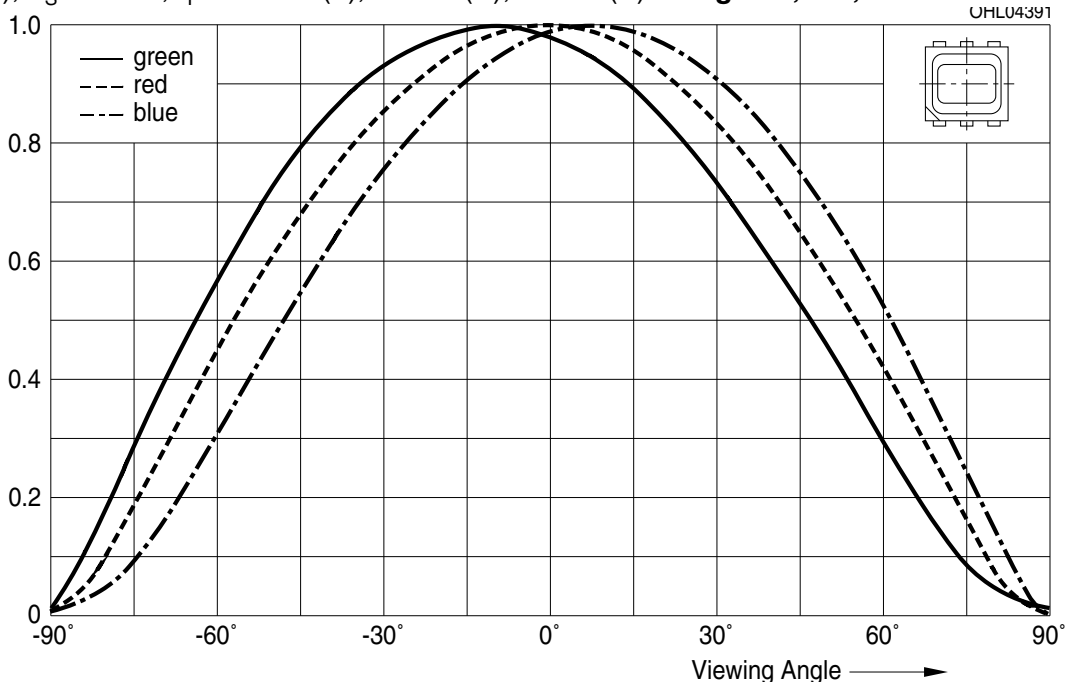

**Durchlassstrom**<sup>6) Seite 27</sup>  
**Forward Current**<sup>6) page 27</sup>

$I_F = f(V_F); T_S = 25\text{ °C};$  true green, blue

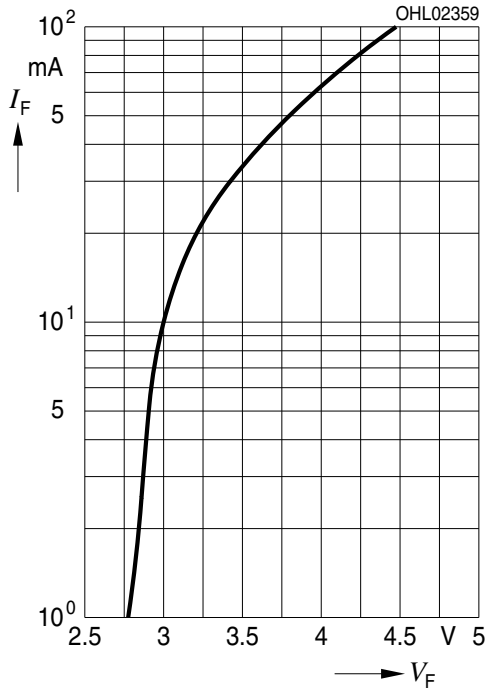

**Durchlassstrom**<sup>6) Seite 27</sup>  
**Forward Current**<sup>6) page 27</sup>

$I_F = f(V_F); T_S = 25\text{ °C};$  red

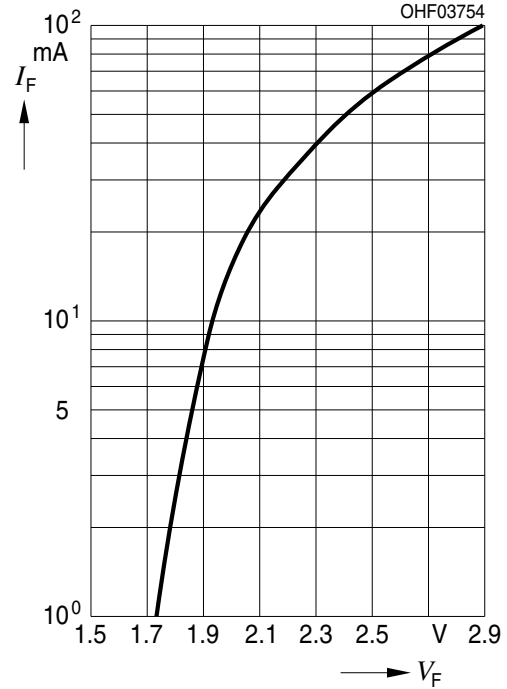

**Relative Lichtstärke**<sup>6) 7) Seite 27</sup>  
**Relative Luminous Intensity**<sup>6) 7) page 27</sup>

$I_V/I_V(20\text{ mA}) = f(I_F); T_S = 25\text{ °C}$

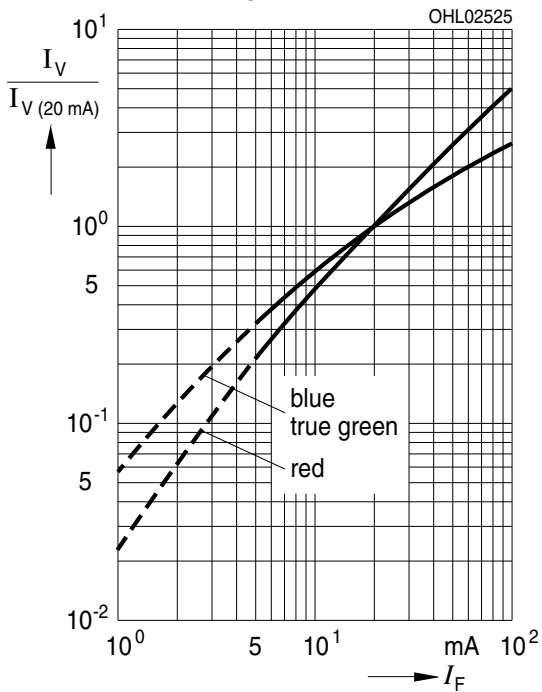

Dominante Wellenlänge<sup>6)</sup> Seite 27

Dominant Wavelength<sup>6)</sup> page 27

blue,  $\lambda_{\text{dom}} = f(I_F); T_S = 25\text{ °C}$

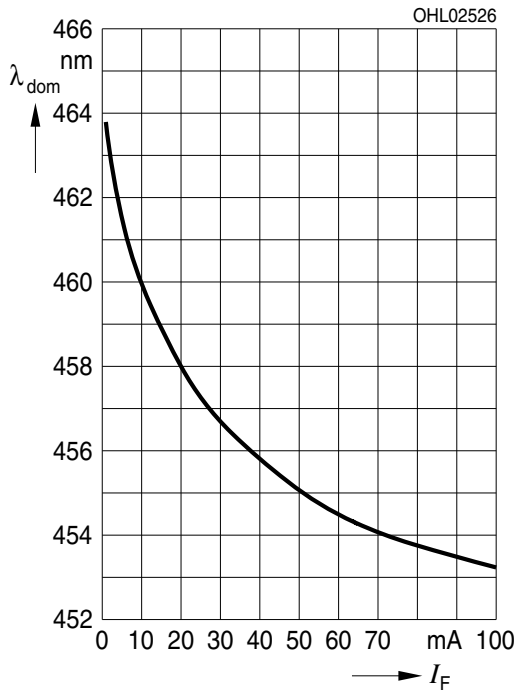

Dominante Wellenlänge<sup>6)</sup> Seite 27

Dominant Wavelength<sup>6)</sup> page 27

true green,  $\lambda_{\text{dom}} = f(I_F); T_S = 25\text{ °C}$

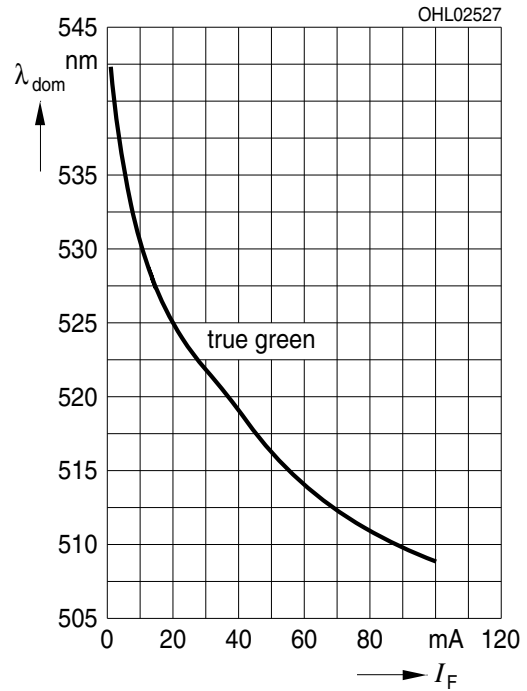

Relative Lichtstärke<sup>6)</sup> Seite 27

Relative Luminous Intensity<sup>6)</sup> page 27

$I_V/I_V(25\text{ °C}) = f(T_j); I_F = 20\text{ mA}$

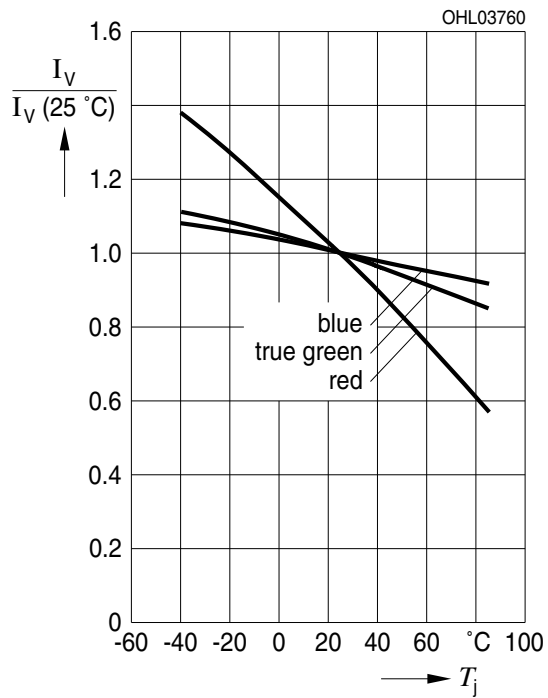

Relative Lichtstärke<sup>6) 7) Seite 27</sup>

Relative Luminous Intensity<sup>6) 7) page 27</sup>

$$I_V/I_{Vgroup} = f(I_F/I_{Fgroup}); T_S = 25\text{ °C}$$

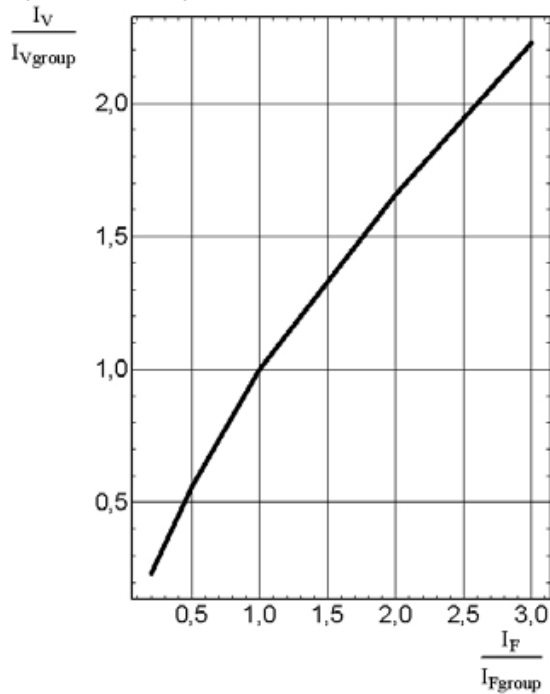

Farbortverschiebung<sup>2) Seite 27</sup>

Chromaticity Coordinate Shift<sup>2) page 27</sup>

$$\Delta Cx, \Delta Cy = f(I_F/I_{Fgroup}); T_S = 25\text{ °C}$$

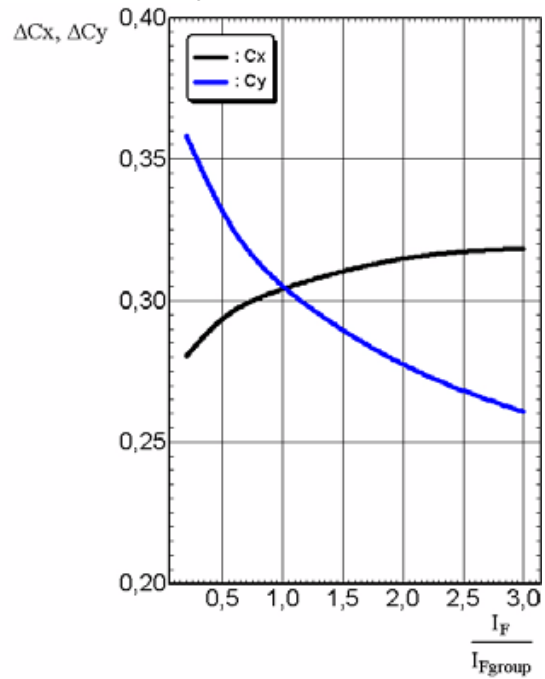

Relative Lichtstärke<sup>6) 7) Seite 27</sup>

Relative Luminous Intensity<sup>6) 7) page 27</sup>

$$I_V/I_V(25\text{ °C}) = f(T_j); I_F = I_{Fgroup}$$

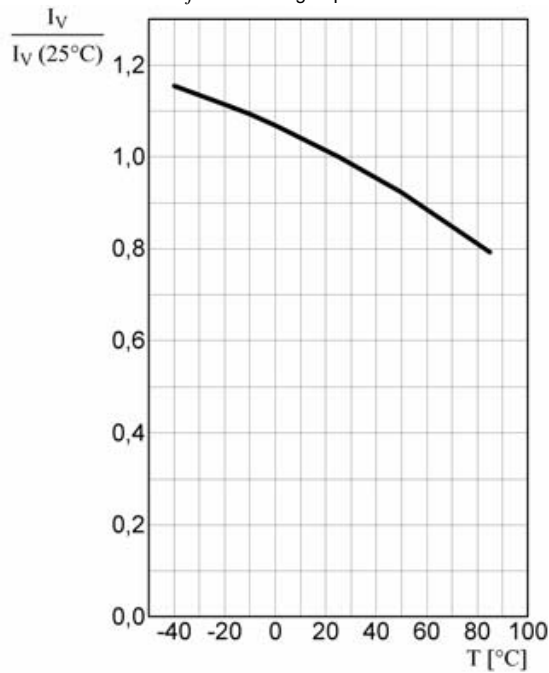

Farbortverschiebung<sup>2) Seite 27</sup>

Chromaticity Coordinate Shift<sup>2) page 27</sup>

$$\Delta Cx, \Delta Cy = f(T_j); I_F = I_{Fgroup}$$

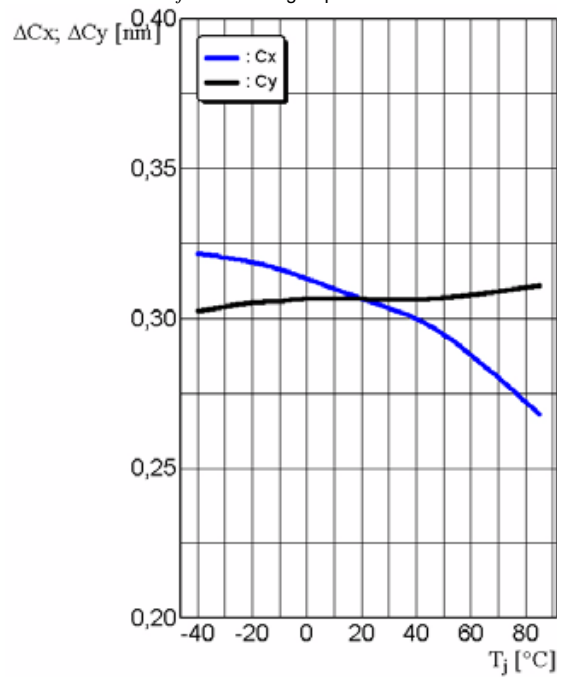

**Maximal zulässiger Durchlassstrom rot**  
**Max. Permissible Forward Current red**  
 $I_F = f(T)$ ; 1 chip on

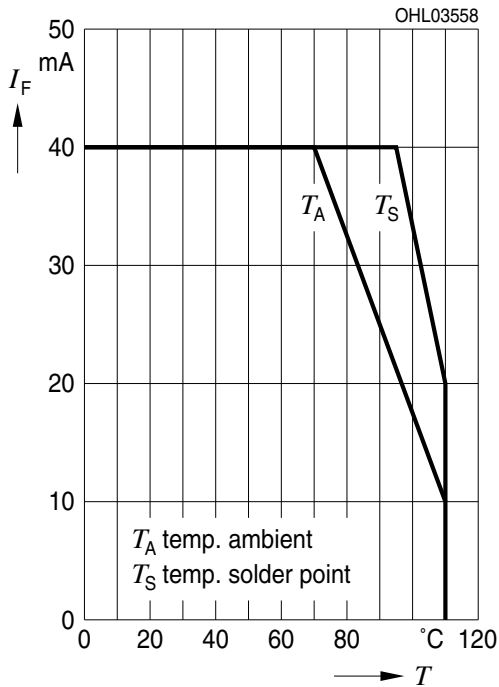

**Maximal zulässiger Durchlassstrom rot**  
**Max. Permissible Forward Current red**  
 $I_F = f(T)$ ; 3 chips on

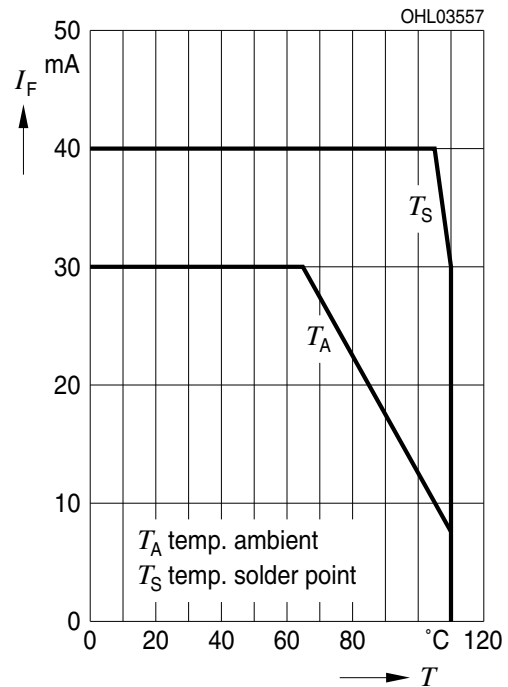

**Maximal zulässiger Durchlassstrom true grün**  
**Max. Permissible Forward Current true green**  
 $I_F = f(T)$ ; 1 chip on

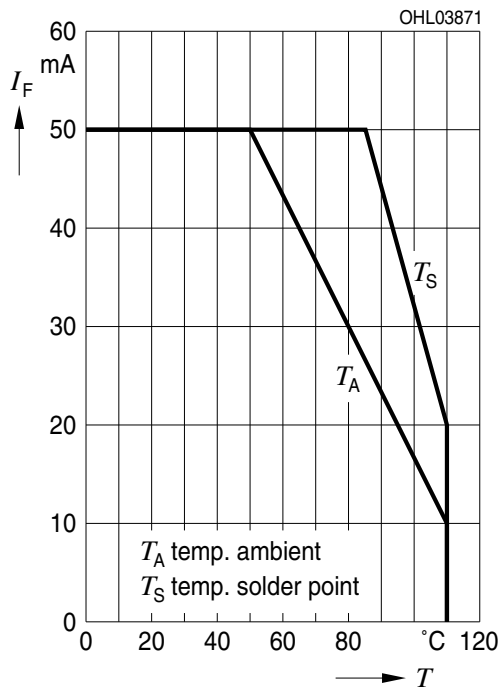

**Maximal zulässiger Durchlassstrom true grün**  
**Max. Permissible Forward Current true green**  
 $I_F = f(T)$ ; 3 chips on

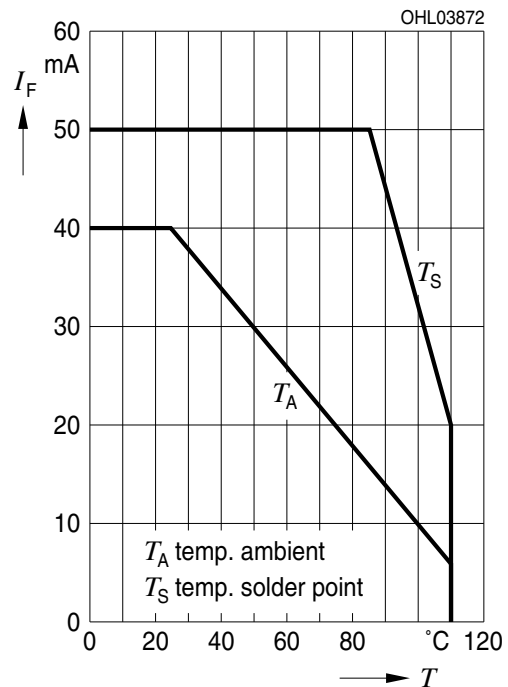

**Maximal zulässiger Durchlassstrom blau**  
**Max. Permissible Forward Current blue**

$I_F = f(T)$ ; 1 chip on

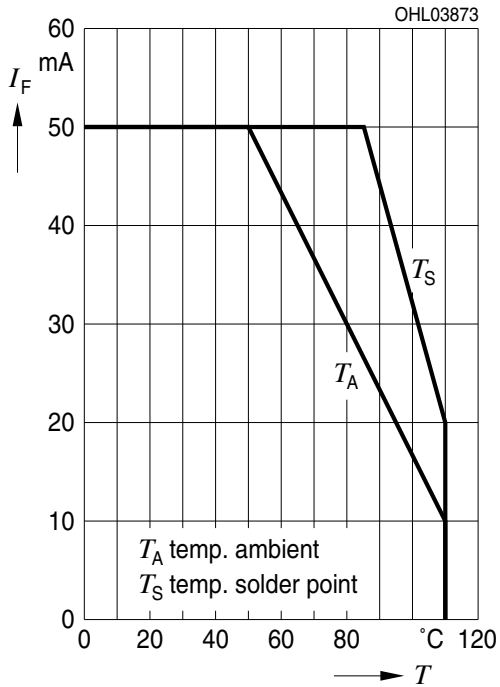

**Maximal zulässiger Durchlassstrom blau**  
**Max. Permissible Forward Current blue**

$I_F = f(T)$ ; 3 chips on

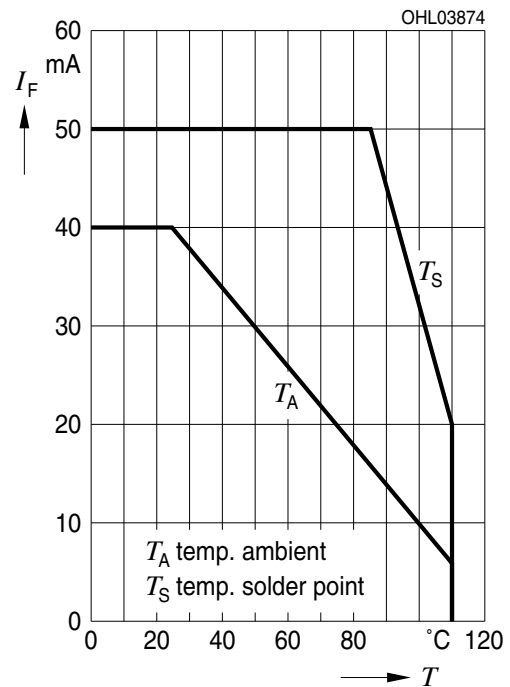



**Zulässige Impulsbelastbarkeit**  
**Permissible Pulse Handling Capability**  
 Duty cycle  $D =$  parameter,  $T_S = 25\text{ °C}$   
 $I_F = f(t_p)$ ; true green (1 Chip on)

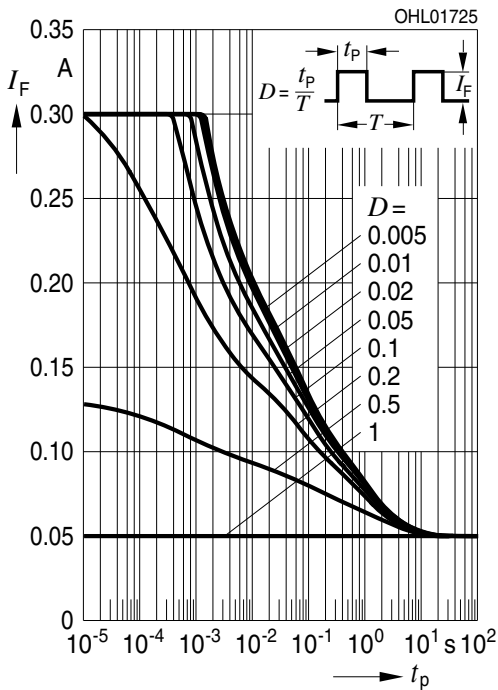

**Zulässige Impulsbelastbarkeit**  
**Permissible Pulse Handling Capability**  
 Duty cycle  $D =$  parameter,  $T_S = 25\text{ °C}$   
 $I_F = f(t_p)$ ; true green (3 Chips on)

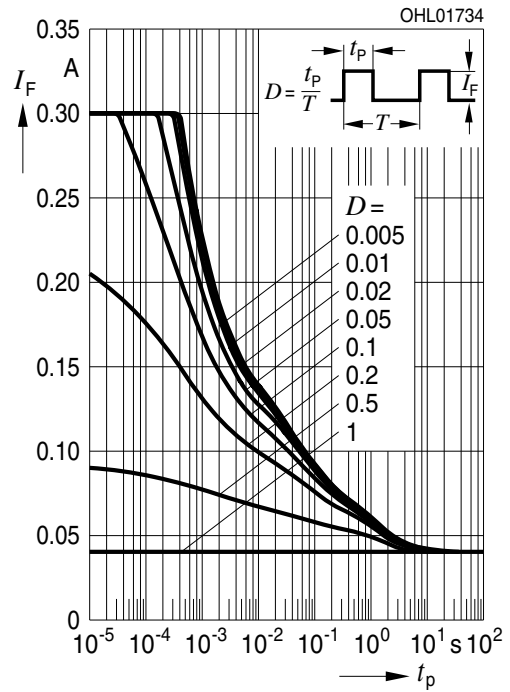

**Zulässige Impulsbelastbarkeit**  
**Permissible Pulse Handling Capability**  
 Duty cycle  $D =$  parameter,  $T_S = 85\text{ °C}$   
 $I_F = f(t_p)$ ; true green (1 Chip on)

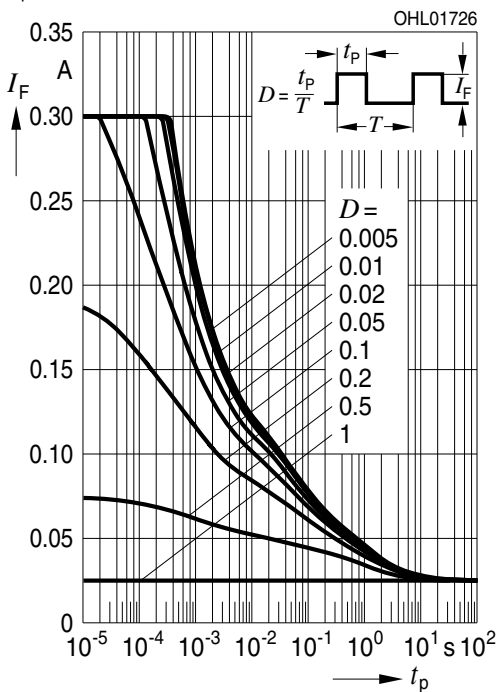

**Zulässige Impulsbelastbarkeit**  
**Permissible Pulse Handling Capability**  
 Duty cycle  $D =$  parameter,  $T_S = 85\text{ °C}$   
 $I_F = f(t_p)$ ; true green (3 Chips on)

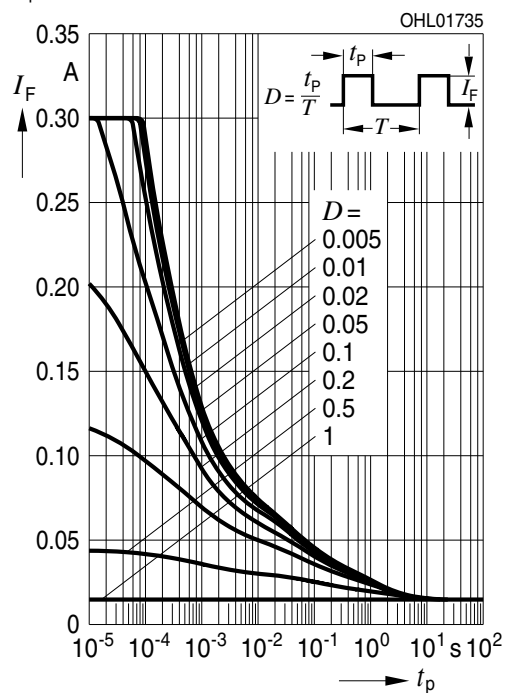

**Zulässige Impulsbelastbarkeit**  
**Permissible Pulse Handling Capability**  
 Duty cycle  $D = \text{parameter}$ ,  $T_S = 25\text{ °C}$   
 $I_F = f(t_p)$ ; red (1 Chip on)

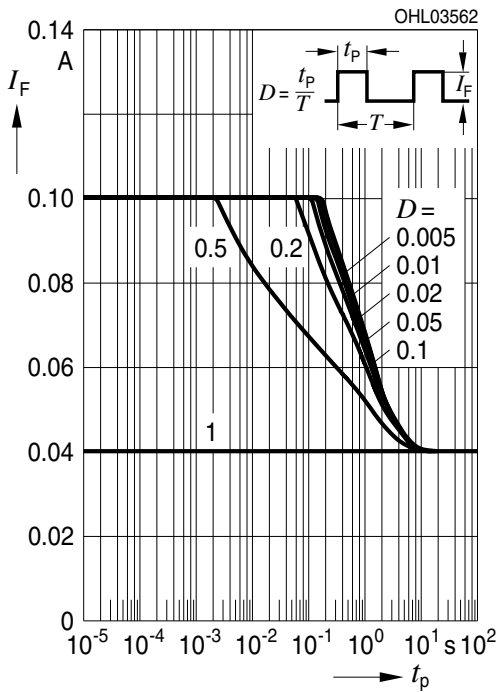

**Zulässige Impulsbelastbarkeit**  
**Permissible Pulse Handling Capability**  
 Duty cycle  $D = \text{parameter}$ ,  $T_S = 25\text{ °C}$   
 $I_F = f(t_p)$ ; red (3 Chips on)

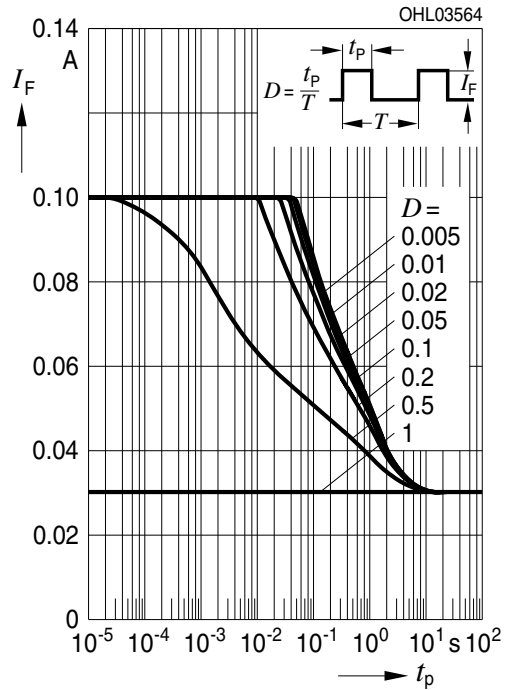

**Zulässige Impulsbelastbarkeit**  
**Permissible Pulse Handling Capability**  
 Duty cycle  $D = \text{parameter}$ ,  $T_S = 85\text{ °C}$   
 $I_F = f(t_p)$ ; red (1 Chip on)

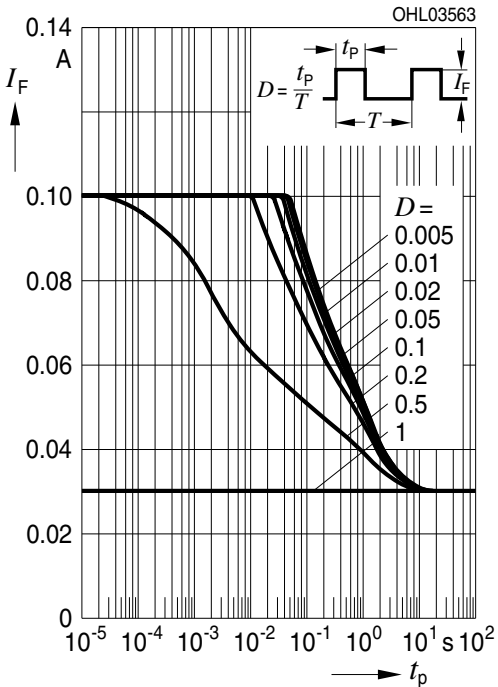

**Zulässige Impulsbelastbarkeit**  
**Permissible Pulse Handling Capability**  
 Duty cycle  $D = \text{parameter}$ ,  $T_S = 85\text{ °C}$   
 $I_F = f(t_p)$ ; red (3 Chips on)

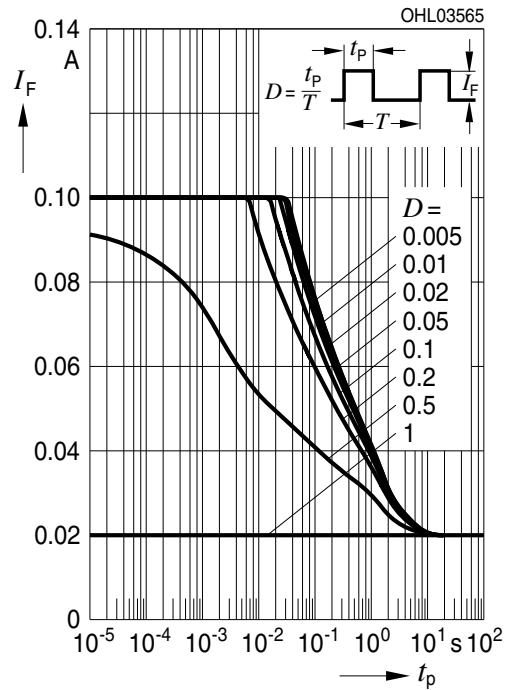

**Zulässige Impulsbelastbarkeit**  
**Permissible Pulse Handling Capability**  
 Duty cycle  $D = \text{parameter}$ ,  $T_S = 25\text{ °C}$   
 $I_F = f(t_p)$ ; blue (1 Chip on)

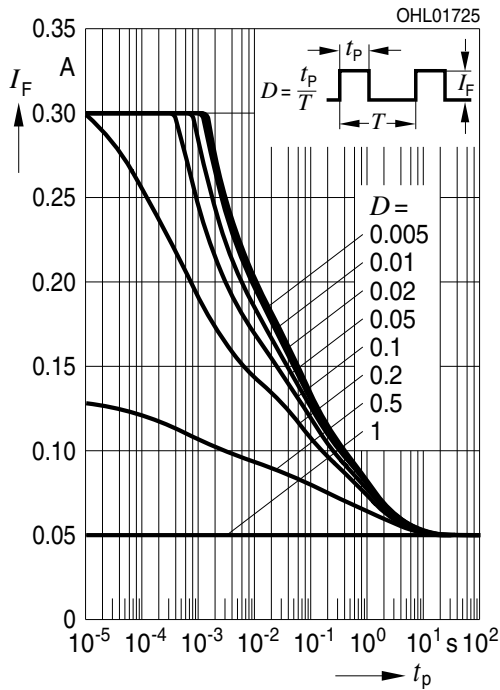

**Zulässige Impulsbelastbarkeit**  
**Permissible Pulse Handling Capability**  
 Duty cycle  $D = \text{parameter}$ ,  $T_S = 25\text{ °C}$   
 $I_F = f(t_p)$ ; blue (3 Chips on)

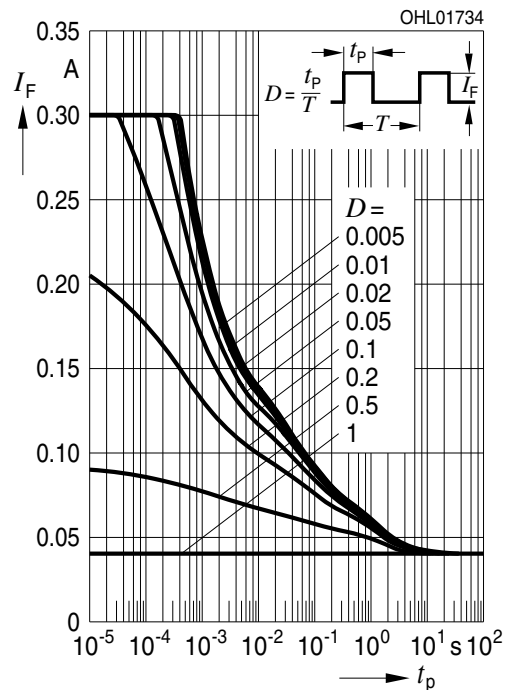

**Zulässige Impulsbelastbarkeit**  
**Permissible Pulse Handling Capability**  
 Duty cycle  $D = \text{parameter}$ ,  $T_S = 85\text{ °C}$   
 $I_F = f(t_p)$ ; blue (1 Chip on)

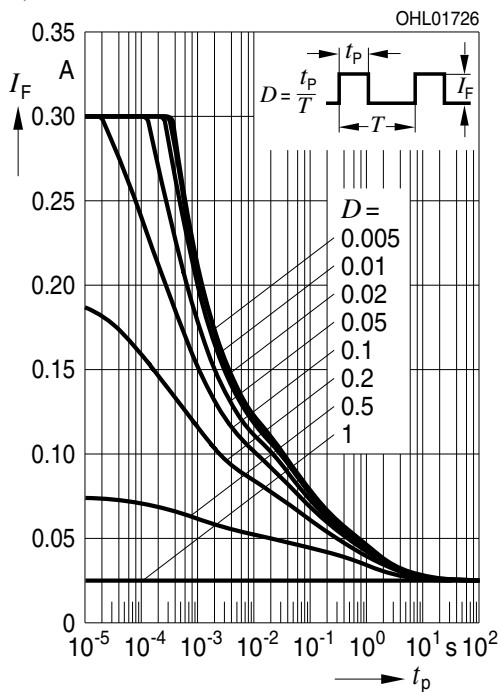

**Zulässige Impulsbelastbarkeit**  
**Permissible Pulse Handling Capability**  
 Duty cycle  $D = \text{parameter}$ ,  $T_S = 85\text{ °C}$   
 $I_F = f(t_p)$ ; blue (3 Chips on)

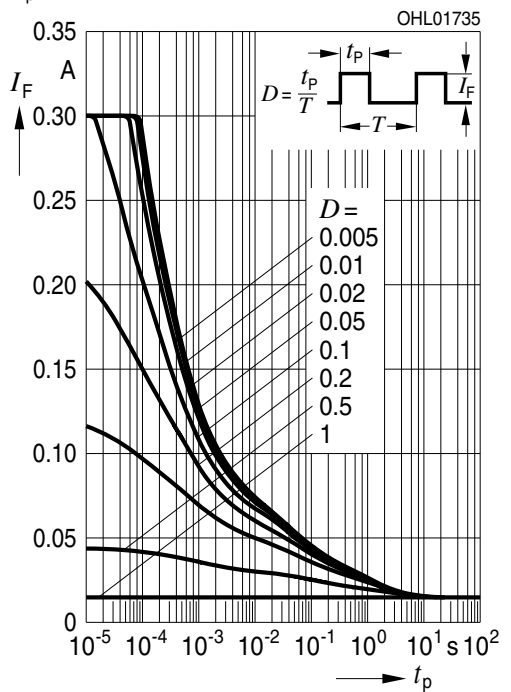

Maßzeichnung<sup>8)</sup> Seite 27  
 Package Outlines<sup>8)</sup> page 27

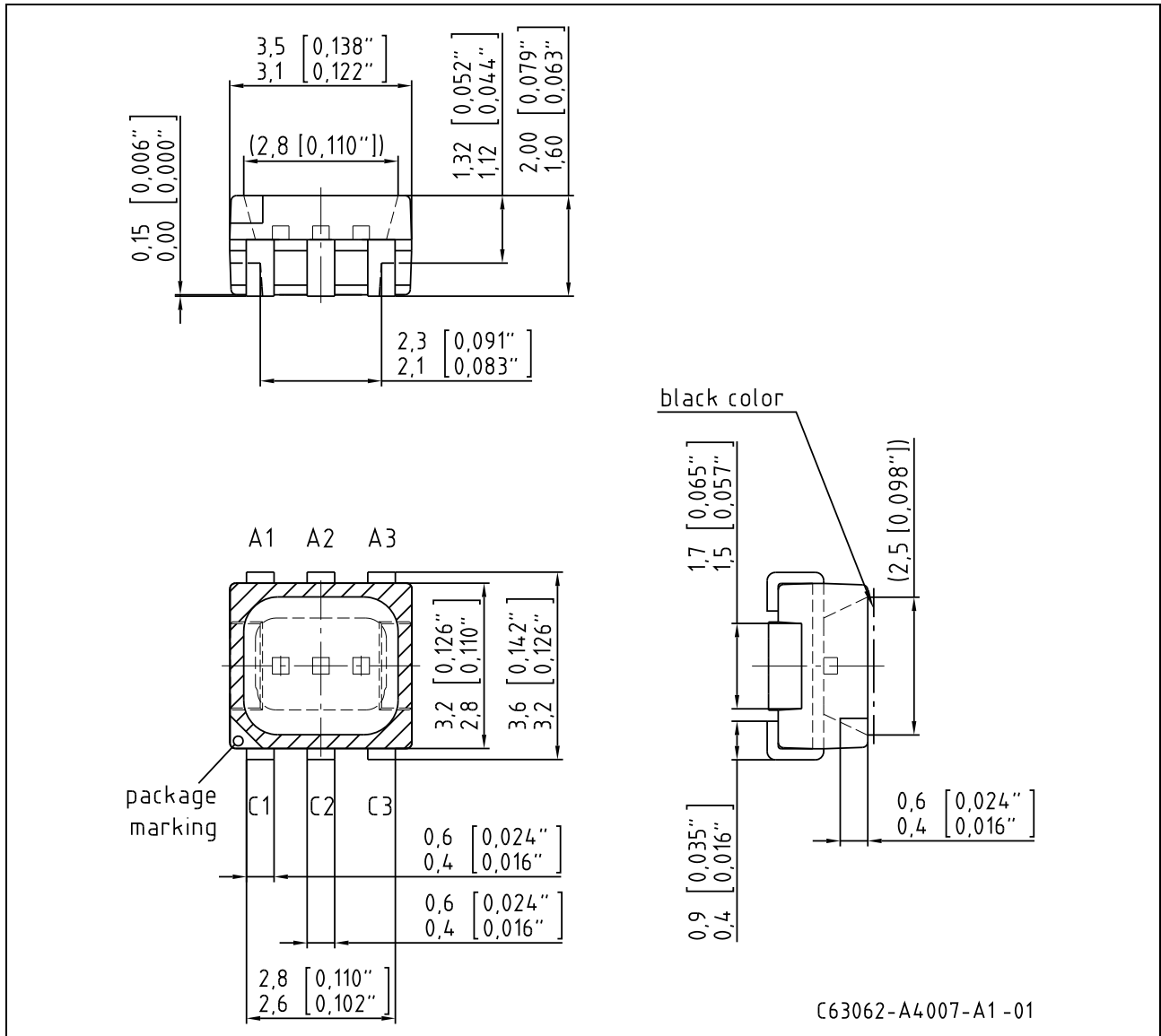

C1	Cathode	Blue (B)
A1	Anode	Blue (B)
C2	Cathode	Red (R)
A2	Anode	Red (R)
C3	Cathode	True Green (T)
A3	Anode	True Green (T)

Gewicht / Approx. weight:

40 mg

Gurtung / Polarität und Lage<sup>8)</sup> Seite 27

Verpackungseinheit 1000/Rolle, ø180 mm

Method of Taping / Polarity and Orientation<sup>8)</sup> page 27

Packing unit 1000/reel, ø180 mm

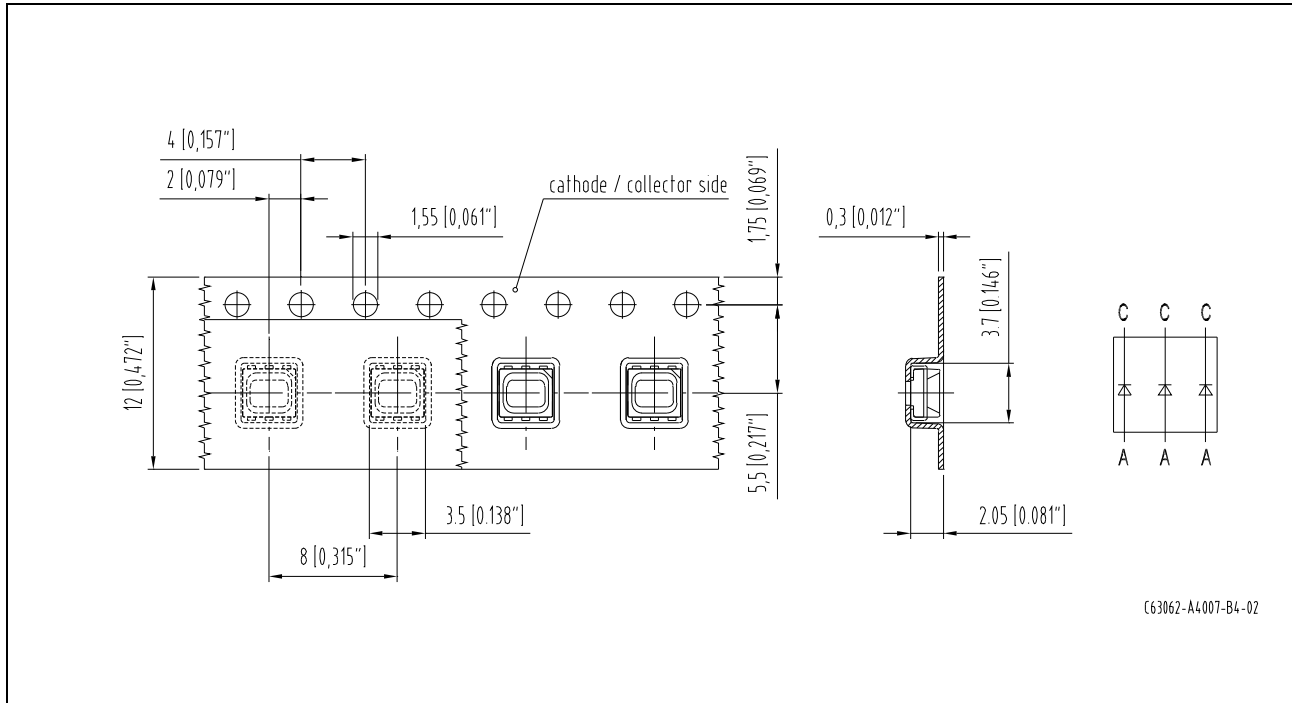

Empfohlenes Lötpad<sup>8) 9)</sup> Seite 27  
 Recommended Solder Pad<sup>8) 9)</sup> page 27

Reflow Löten  
 Reflow Soldering

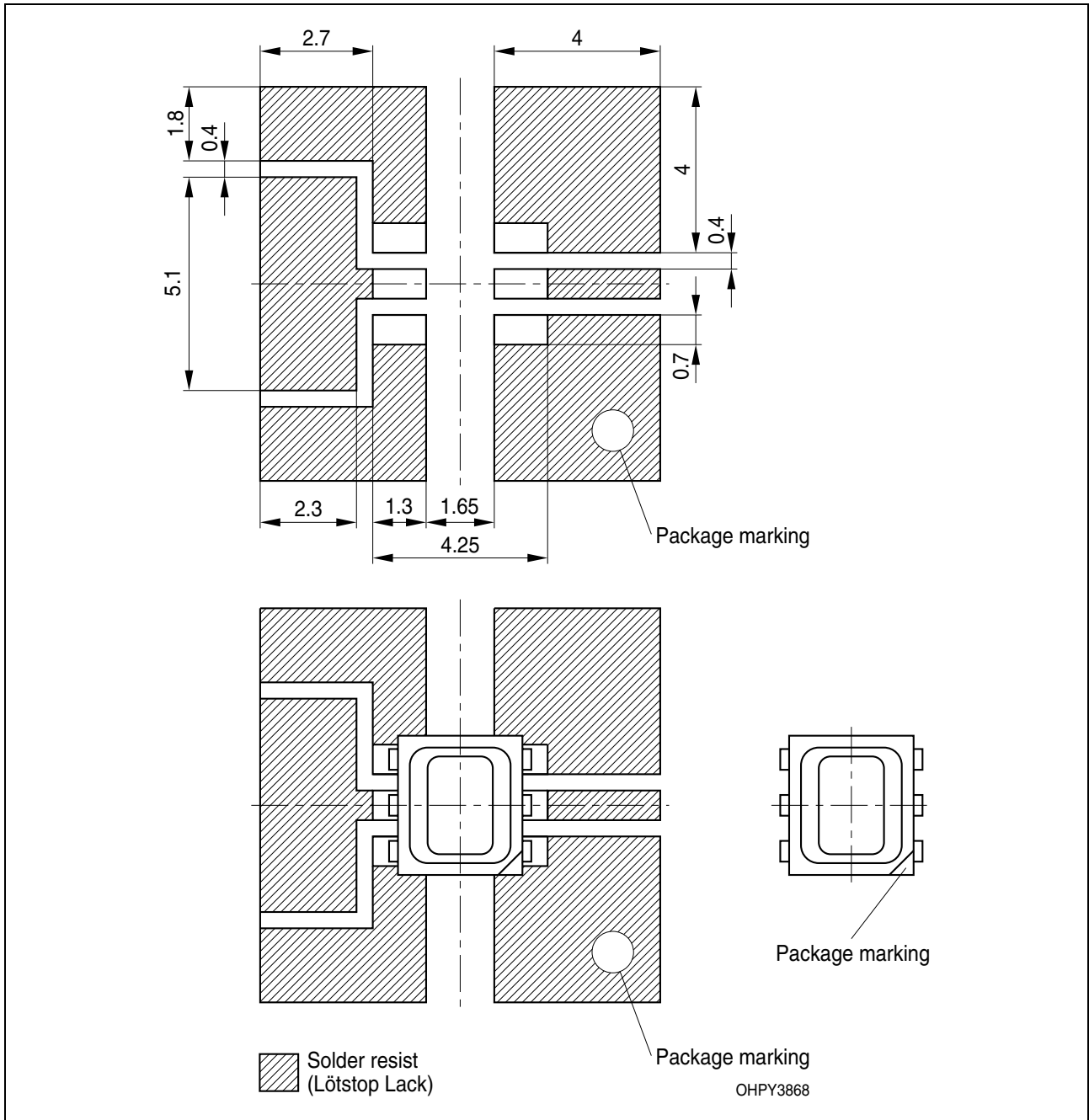

**Lötbedingungen**  
**Soldering Conditions**

Vorbehandlung nach JEDEC Level 4  
 Preconditioning acc. to JEDEC Level 4

**Reflow Lötprofil für bleifreies Löt**  
**Reflow Soldering Profile for lead free soldering**

(nach J-STD-020C)  
 (acc. to J-STD-020C)

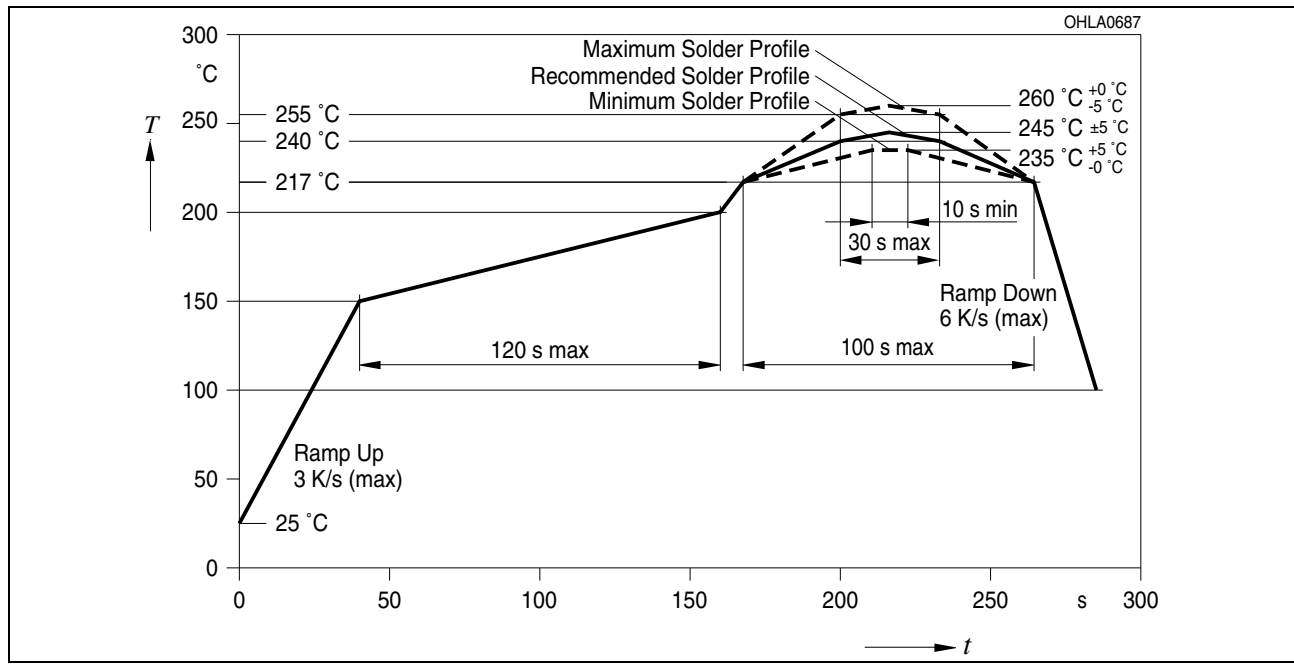

**Barcode-Produkt-Etikett (BPL)**  
**Barcode-Product-Label (BPL)**

OSRAM Opto Semiconductors

Lxxx xxxx Bin1: Bin Information Color 1  
 Product Name Bin2: Bin Information Color 2  
 Bin3: Bin Information Color 3

(6P) BATCH NO: Batch Number RoHS Compliant ML Temp ST  
 2 245 C RT

(1T) LOT NO: Lot Number (9D) D/C: Date Code Additional TEXT  
 R077 DEMY  
 PACKVAR: Packing Type

(X) PROD NO: Product Code (Q) QTY: Product Quantity per Reel (G) GROUP: X-X-X+X-X-X+X-X-X  
 Color 1 Color 2 Color 3  
 Forward Voltage Group  
 Wavelength Group  
 Brightness Group

OHA32043

**Gurtverpackung**  
**Tape and Reel**

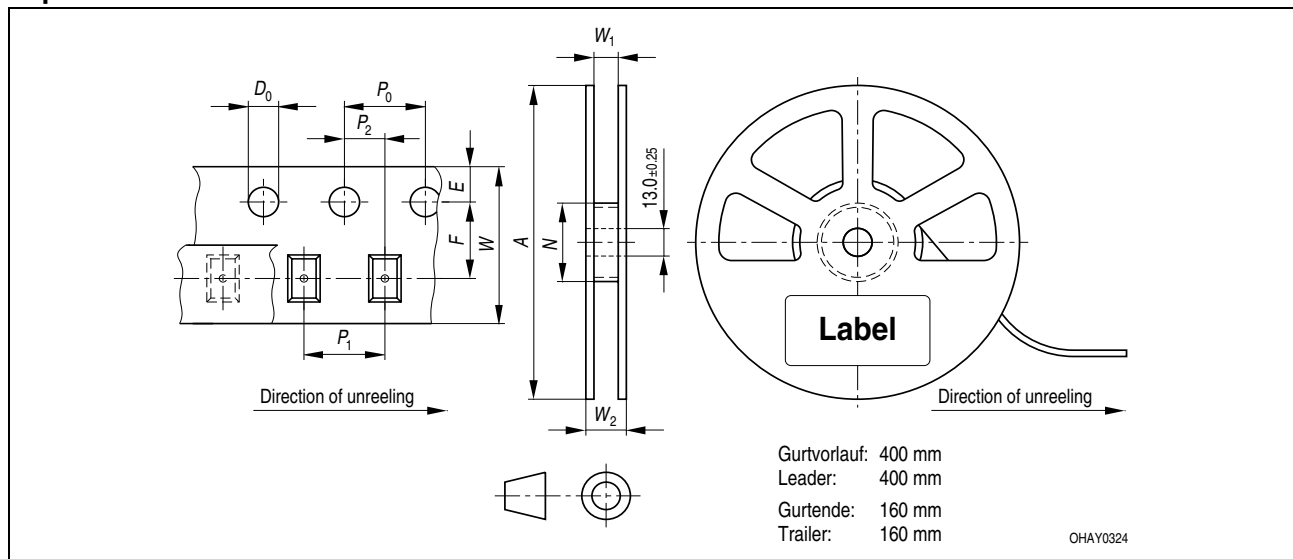

Tape dimensions in mm (inch)

W	P <sub>0</sub>	P <sub>1</sub>	P <sub>2</sub>	D <sub>0</sub>	E	F
12 <sup>+0.3</sup> <sub>-0.1</sub>	4 ± 0.1 (0.157 ± 0.004)	8 ± 0.1 (0.315 ± 0.004)	2 ± 0.05 (0.079 ± 0.002)	1.5 ± 0.1 (0.059 ± 0.004)	1.75 ± 0.1 (0.069 ± 0.004)	5.5 ± 0.05 (0.217 ± 0.002)

Reel dimensions in mm (inch)

A	W	N <sub>min</sub>	W <sub>1</sub>	W <sub>2 max</sub>
180 (7)	12 (0.472)	60 (2.362)	12.4 + 2 (0.488 + 0.079)	18.4 (0.724)



**Trockenverpackung und Materialien**  
**Dry Packing Process and Materials**

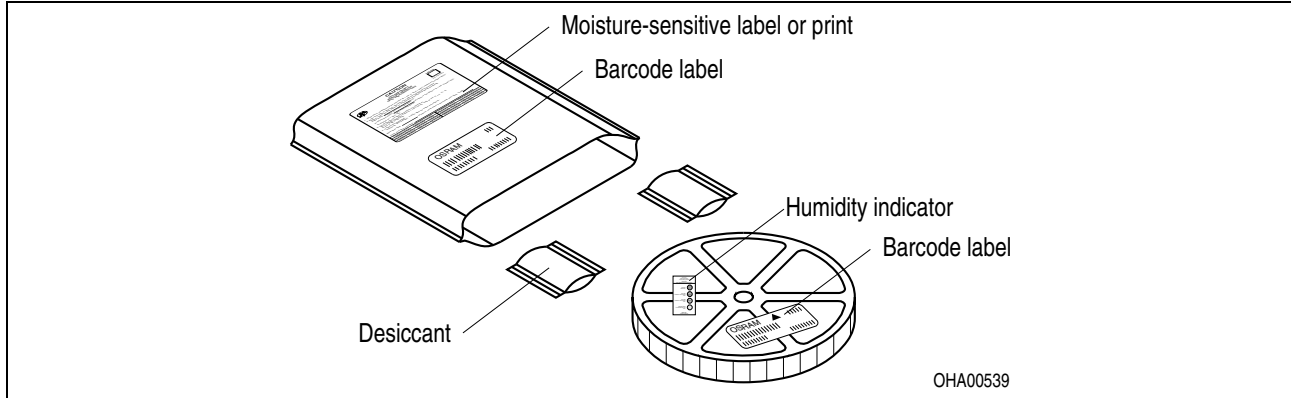

Anm.: Feuchteempfindliche Produkte sind verpackt in einem Trockenbeutel zusammen mit einem Trockenmittel und einer Feuchteindikatorkarte

Bezüglich Trockenverpackung finden Sie weitere Hinweise im Internet und in unserem Short Form Catalog im Kapitel "Gurtung und Verpackung" unter dem Punkt "Trockenverpackung". Hier sind Normenbezüge, unter anderem ein Auszug der JEDEC-Norm, enthalten.

Note: Moisture-sensitive product is packed in a dry bag containing desiccant and a humidity card.

Regarding dry pack you will find further information in the internet and in the Short Form Catalog in chapter "Tape and Reel" under the topic "Dry Pack". Here you will also find the normative references like JEDEC.

**Kartonverpackung und Materialien**  
**Transportation Packing and Materials**

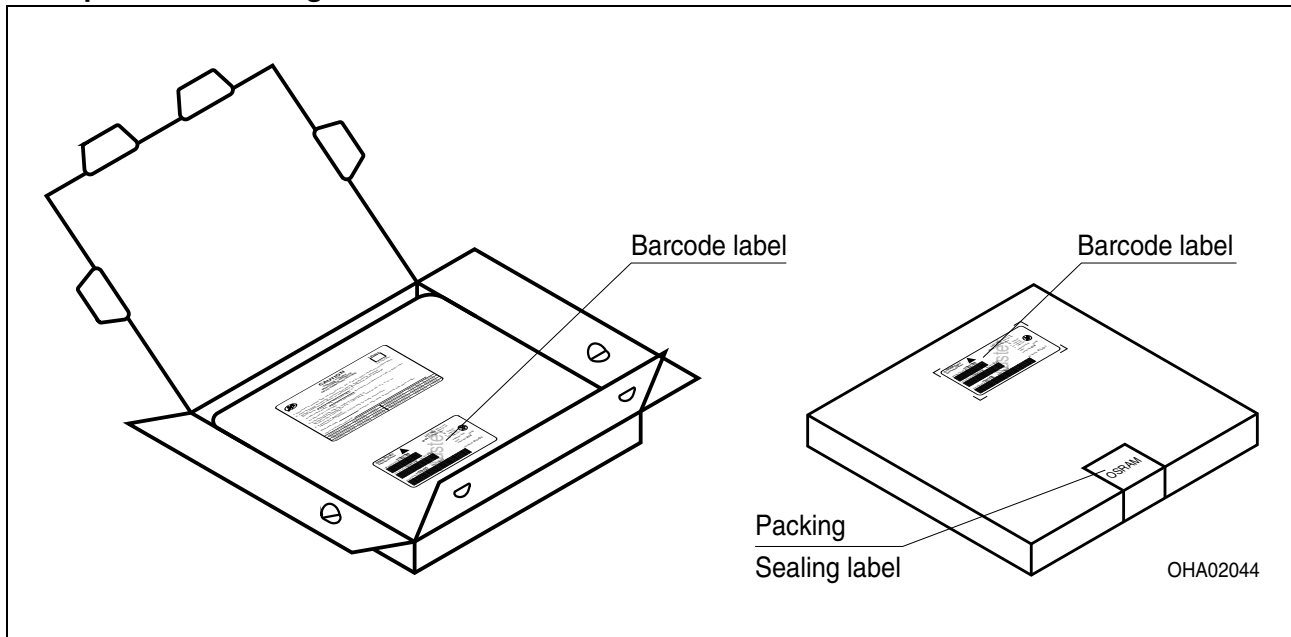

Dimensions of transportation box in mm (inch)

Breite / Width	Länge / length	Höhe / height
200 ±5 (7,874 ±0,1968±)	200 ±5 (7,874 ±0,1968)	30 ±5 (1,1811 ±0,1968)

**Revision History: 2010-02-12**

Previous Version: -

Page	Subjects (major changes since last revision)	Date of change
all	Final Datasheet created	2010-02-12

**Attention please!**

The information describes the type of component and shall not be considered as assured characteristics. Terms of delivery and rights to change design reserved. Due to technical requirements components may contain dangerous substances. For information on the types in question please contact our Sales Organization. If printed or downloaded, please find the latest version in the Internet.

**Packing**

Please use the recycling operators known to you. We can also help you – get in touch with your nearest sales office. By agreement we will take packing material back, if it is sorted. You must bear the costs of transport. For packing material that is returned to us unsorted or which we are not obliged to accept, we shall have to invoice you for any costs incurred.

**Components used in life-support devices or systems must be expressly authorized for such purpose!** Critical components<sup>10) page 27</sup> may only be used in life-support devices or systems<sup>11) page 27</sup> with the express written approval of OSRAM OS.

2010-02-12

26

**Fußnoten:**

- 1) Helligkeitswerte werden während eines Strompulses einer typischen Dauer von 25 ms, mit einer internen Reproduzierbarkeit von +/- 8 % und einer erweiterten Messunsicherheit von +/- 11 % gemessen (gemäß GUM mit Erweiterungsfaktor  $k = 3$ ).
- 2) Die LED kann kurzzeitig in Sperrichtung betrieben werden.
- 3)  $R_{thJA}$  ergibt sich bei Montage auf PC-Board FR 4 (Padgröße  $\geq 16 \text{ mm}^2$  je Pad)
- 4) Die dominante Wellenlänge wird während eines Strompulses einer typischen Dauer von 25 ms, mit einer internen Reproduzierbarkeit von +/- 0,5 nm und einer erweiterten Messunsicherheit von +/- 1 nm gemessen (gemäß GUM mit Erweiterungsfaktor  $k = 3$ ).
- 5) Vorwärtsspannungen werden während eines Strompulses einer typischen Dauer von 8 ms, mit einer internen Reproduzierbarkeit von +/- 0,05 V und einer erweiterten Messunsicherheit von +/- 0,1 V gemessen (gemäß GUM mit Erweiterungsfaktor  $k=3$ ).
- 6) Wegen der besonderen Prozessbedingungen bei der Herstellung von LED können typische oder abgeleitete technische Parameter nur aufgrund statistischer Werte wiedergegeben werden. Diese stimmen nicht notwendigerweise mit den Werten jedes einzelnen Produktes überein, dessen Werte sich von typischen und abgeleiteten Werten oder typischen Kennlinien unterscheiden können. Falls erforderlich, z.B. aufgrund technischer Verbesserungen, werden diese typischen Werte ohne weitere Ankündigung geändert.
- 7) Im gestrichelten Bereich der Kennlinien muss mit erhöhten Helligkeitsunterschieden zwischen Leuchtdioden innerhalb einer Verpackungseinheit gerechnet werden. Dimmverhältnis im Gleichstrom-Betrieb max. 5:1 für red Maße werden wie folgt angegeben: mm (inch)
- 8) Gehäuse hält TTW-Löthitze aus nach CECC 00802
- 10) Ein kritisches Bauteil ist ein Bauteil, das in lebenserhaltenden Apparaten oder Systemen eingesetzt wird und dessen Defekt voraussichtlich zu einer Fehlfunktion dieses lebenserhaltenden Apparates oder Systems führen wird oder die Sicherheit oder Effektivität dieses Apparates oder Systems beeinträchtigt.
- 11) Lebenserhaltende Apparate oder Systeme sind für
  - (a) die Implantierung in den menschlichen Körper oder
  - (b) für die Lebenserhaltung bestimmt.
 Falls sie versagen, kann davon ausgegangen werden, dass die Gesundheit und das Leben des Patienten in Gefahr ist.

**Remarks:**

- 1) Brightness values are measured during a current pulse of typical 25 ms, with an internal reproducibility of +/- 8 % and an expanded uncertainty of +/- 11 % (acc. to GUM with an coverage factor of  $k = 3$ ).
- 2) Driving the LED in reverse direction is suitable for short term application.
- 3)  $R_{thJA}$  results from mounting on PC board FR 4 (pad size  $\geq 16 \text{ mm}^2$  per pad)
- 4) The dominant wavelength is measured at a current pulse of typical 25 ms, with an internal reproducibility of +/- 0,5 nm and an expanded uncertainty of +/- 1 nm (acc. to GUM with an coverage factor of  $k=3$ ).
- 5) The forward voltage is measured during a current pulse of typical 8 ms, with an internal reproducibility of +/- 0,05 V and an expanded uncertainty of +/- 0,1 V (acc. to GUM with an coverage factor of  $k=3$ ).
- 6) Due to the special conditions of the manufacturing processes of LED, the typical data or calculated correlations of technical parameters can only reflect statistical figures. These do not necessarily correspond to the actual parameters of each single product, which could differ from the typical data and calculated correlations or the typical characteristic line. If requested, e.g. because of technical improvements, these typ. data will be changed without any further notice.
- 7) In the range where the line of the graph is broken, you must expect higher brightness differences between single LEDs within one packing unit.  
Dimming range for direct current mode max. 5:1 for red
- 8) Dimensions are specified as follows: mm (inch)
- 9) Package able to withstand TTW-soldering heat acc. to CECC 00802
- 10) A critical component is a component used in a life-support device or system whose failure can reasonably be expected to cause the failure of that life-support device or system, or to affect its safety or the effectiveness of that device or system.
- 11) Life support devices or systems are intended
  - (a) to be implanted in the human body,
  - or
  - (b) to support and/or maintain and sustain human life. If they fail, it is reasonable to assume that the health and the life of the user may be endangered.

Published by  
**OSRAM Opto Semiconductors GmbH**  
 Leibnizstrasse 4, D-93055 Regensburg  
[www.osram-os.com](http://www.osram-os.com)  
 © All Rights Reserved.

EU RoHS and China RoHS compliant product



此产品符合欧盟 RoHS 指令的要求；

按照中国的相关法规和标准，不含有毒有害物质或元素。