

PAN14

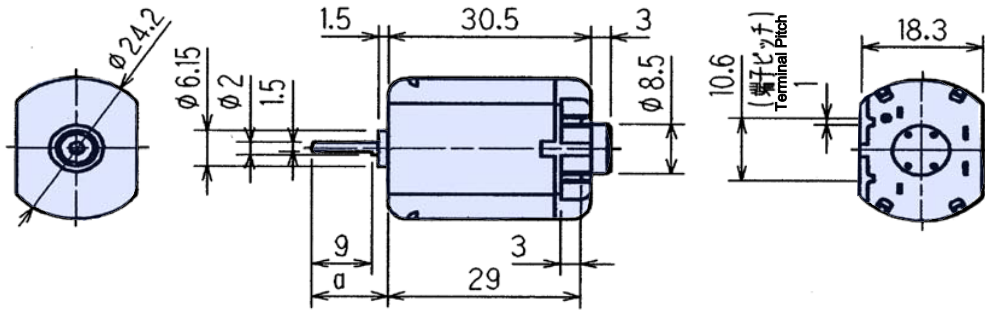

Weight: 39.0 g

Outline UNIT:mm



Specifications

Model	Operating Voltage (V)	Rated Voltage (V)	No Load Speed (min ⁻¹)	No Load Current (mA)	Rated Load		Rated Load Speed (min ⁻¹)	Rated Load Current (mA)	Starting Torque		Starting Current (mA)	Shaft Length (mm)
					(gf·cm)	(mN·m)			(gf·cm)	(mN·m)		
PAN14EE12AB	9 to 16	12.0	11050	70	50.0	4.9	9094	563	282.5	27.7	2857	a=11.5
PAN14EE12AA1	9 to 14.5	12.0	14974	116	50.0	4.9	12850	792	352.4	34.5	4878	a=11.5

Characteristics

