

CAT3661

1-Channel Low-Power Quad-Mode[®] LED Driver

Description

The CAT3661 is a high efficiency low power quad-mode fractional charge pump that drives one LED with up to 5 mA of current. Soft-start current limiting and short-circuit protection are optimized for use with coin cell batteries.

Low noise input ripple and constant switching frequency allows the use of small external ceramic capacitors. This makes the CAT3661 ideal for EMI sensitive applications. The quad-mode charge pump supports a wide range of input voltages from 2.0 V to 5.5 V.

The CAT3661 has a built-in circuitry to provide feedback to a microcontroller of Open/Short LED and Low battery events. The Low battery indicator trip point is internally fixed at 2.4 V. External resistors can be added to raise or lower the trip voltage, if needed.

The device is packaged in the tiny 16-lead TQFN 3 mm x 3 mm package with a max height of 0.8 mm.

The inclusion of a 1.33x fractional charge pump mode increases device efficiency by up to 10% over traditional 1.5x tri-mode charge pumps with no added external capacitors. The 1.33x charge pump with two fly capacitors is a patented architecture exclusive to ON Semiconductor.

Features

- Quad-Mode Charge Pump: 1x, 1.33x, 1.5x, 2x
- Drives One LED up to 5 mA
- Optimized for Coin Cell Battery Operation
- Open/Short LED Fault Detection
- Adjustable Low Battery Detection
- Low Quiescent Current 150 μ A Typical
- Power Efficiency up to 92%
- Low Noise Input Ripple in All Modes
- "Zero" Current Shutdown Mode
- Soft Start and Short Circuit Current Limiting
- Thermal Shutdown Protection
- 3 mm x 3 mm, 16-pad TQFN Package
- This Device is Pb-Free, Halogen Free/BFR Free and is RoHS Compliant

Typical Applications

- Low Power LCD Display Backlight
- Low Power Handheld Device Backlight



ON Semiconductor[®]

<http://onsemi.com>



TQFN-16
HV3 SUFFIX
CASE 510AD

PIN CONNECTIONS

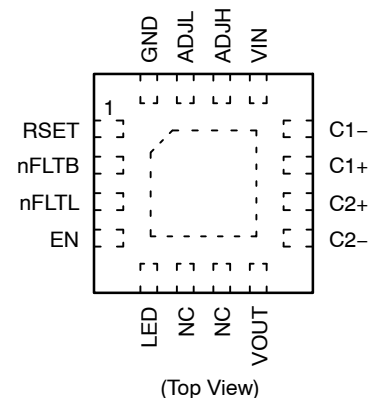

See detailed description of the pins function on page 8 of this data sheet.

MARKING DIAGRAM

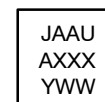

JAAU = CAT3661HV3-GT2
A = Assembly Location
XXX = Last Three Digits of Assembly Lot Number
Y = Production Year (Last Digit)
WW = Production Week (Two Digits)

ORDERING INFORMATION

See detailed ordering and shipping information in the package dimensions section on page 2 of this data sheet.

CAT3661

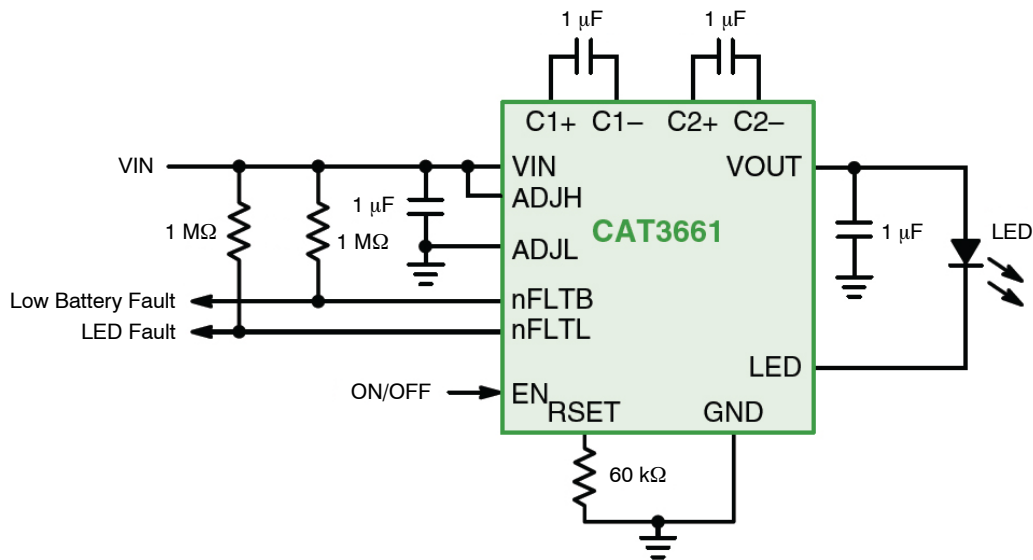

Figure 1. Typical Application Circuit

Table 1. ORDERING INFORMATION

Orderable Part Number	Package	Lead Finish	Shipping (Note 1)
CAT3661HV3-GT2	TQFN	NiPdAu	2,000

1. For information on tape and reel specifications, including part orientation and tape sizes, please refer to our Tape and Reel Packaging Specifications Brochure, BRD8011/D.

Table 2. ABSOLUTE MAXIMUM RATINGS

Parameter	Value	Unit
VIN voltage	GND-0.3 to 6	V
VOUT voltage	GND-0.3 to 7	V
EN, nFLTB, nFLTL, LED, RSET voltage (Note 2)	GND-0.3 to 6	V
C1±, C2± voltage	GND-0.3 to 7	V
Storage Temperature Range	-65 to +160	°C
Junction Temperature Range	-40 to +150	°C
Lead Temperature	300	°C
ESD Rating HBM (Human Body Model)	2000	V
ESD Rating MM (Machine Model)	200	V

Stresses exceeding Maximum Ratings may damage the device. Maximum Ratings are stress ratings only. Functional operation above the Recommended Operating Conditions is not implied. Extended exposure to stresses above the Recommended Operating Conditions may affect device reliability.

2. EN, nFLTL, nFLTB, LED and RSET can be driven above VIN up to the absolute maximum voltage.

Table 3. RECOMMENDED OPERATING CONDITIONS

Parameter	Value	Unit
VIN	2.0 to 5.5	V
Ambient Temperature Range	-40 to +85	°C
LED current	0.1 to 5	mA
nFLTB, nFLTL pull-up resistor current	0 to 1	mA
LED Forward Voltage Range (VF)	1.3 to 4.2	V

CAT3661

Table 4. ELECTRICAL OPERATING CHARACTERISTICS

(Recommended operating conditions unless otherwise specified. C_{IN} , C_{OUT} , C_{FLY} are 1 μ F ceramic capacitors and V_{IN} is set to 3.6 V.)

Parameter	Conditions	Symbol	Min	Typ	Max	Units
Quiescent Current	1x mode, no load, $V_{IN} = 3.4$ V 1.33x mode, no load, $V_{IN} = 3.0$ V 1.5x mode, no load, $V_{IN} = 2.4$ V 2x mode, no load, $V_{IN} = 2.1$ V	I_Q		130 160 160 160		μ A
Shutdown Current	$V_{EN} = 0$ V	I_{QSHDN}			1	μ A
LED Current Accuracy (Chip to Chip)	$(I_{LED} - I_{LEDNOM}) / I_{LEDNOM}$	$I_{LED-ACC}$		± 2		%
LED Current Accuracy	$R_{SET} = 60$ k Ω	I_{LED-3}	2.7	3	3.3	mA
Gain (I_{LED} / I_{RSET})	$I_{LED} = 3$ mA	Gain		300		
RSET Regulated Voltage	$I_{LED} = 3$ mA	V_{RSET}	0.57	0.6	0.63	V
Output Resistance (open loop)	1x mode 1.33x mode, $V_{IN} = 3$ V 1.5x mode, $V_{IN} = 2.7$ V 2x mode, $V_{IN} = 2.4$ V	R_{OUT}		15 40 50 100		Ω
Charge Pump Frequency	1.33x and 2x mode 1.5x mode	F_{OSC}		100 130		kHz
Input Current Limit Gain from I_{RSET}	$I_{LED} = 3$ mA	G_{I_MAX}		1000		
LED Channel Short Detection Voltage	$I_{LED} = 3$ mA	V_{SH}		1		V
LED Channel Short Test Current	$V_{OUT} - V_{LED} < V_{SH}$	I_{SH}		5		μ A
LED Channel Open/Short Timeout	$I_{LED} = 3$ mA	T_{OLED}		2		ms
1x to 1.33x or 1.33x to 1.5x or 1.5x to 2x Transition Thresholds at LED pin		LED_{TH}		100		mV
1x Mode Transition Hysteresis	$I_{LED} = 3$ mA	V_{HYS}		360		mV
Transition Filter Delay		T_{DF}		400		μ s
nFLTB, nFLTL low voltage threshold (Open Drain)	nFLTB, nFLTL Driven low 100 μ A pull up	V_{FLTLO}			0.2	V
EN Pin – Internal Pull-down Resistor – Logic High Level – Logic Low Level		R_{EN} V_{EHI} V_{ELO}	1.3	200	0.4	k Ω V V
Thermal Shutdown		T_{SD}		150		$^{\circ}$ C
Thermal Hysteresis		T_{HYS}		20		$^{\circ}$ C
Low battery V_{in} Trip point Voltage	ADJH = V_{IN} ADJL = GND	V_{LB}	2.30	2.40	2.50	V
Low Battery ADJ Trip Point (Internal)	$V_{IN} = 2.4$ V	V_{ADJ}	0.57	0.6	0.63	V
Low Battery Divider Network Resistance	$R_{HI} + R_{LO}$	R_{ADJ}	640	800	960	k Ω
Low Battery Resistor Divider Gain	$(R_{HI} + R_{LO}) / R_{LO}$	G_{ADJ}		4		
Low battery nFLTB Pulse Duration	Upon EN, $V_{IN} = 2.4$ V	T_{BATTLO}	400	500	600	ms
Undervoltage lockout (UVLO) threshold		V_{UVLO}		1.9		V

CAT3661

TYPICAL CHARACTERISTICS

($V_{IN} = 3\text{ V}$, $I_{LED} = 3\text{ mA}$, $V_F = 3\text{ V}$, $T_{AMB} = 25^\circ\text{C}$, typical application circuit unless otherwise specified.)

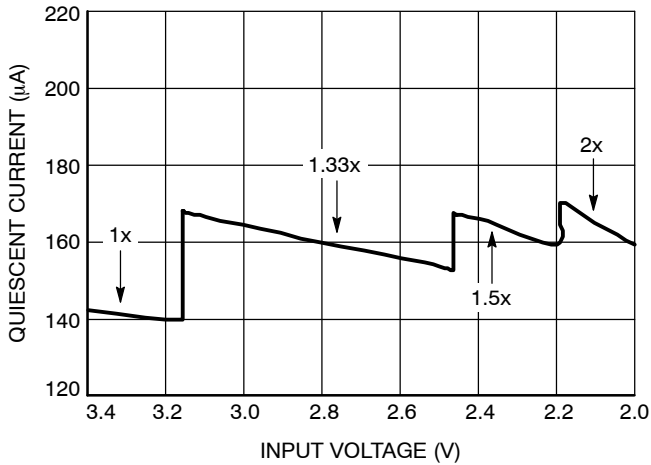

Figure 2. Quiescent Current vs. Input Voltage

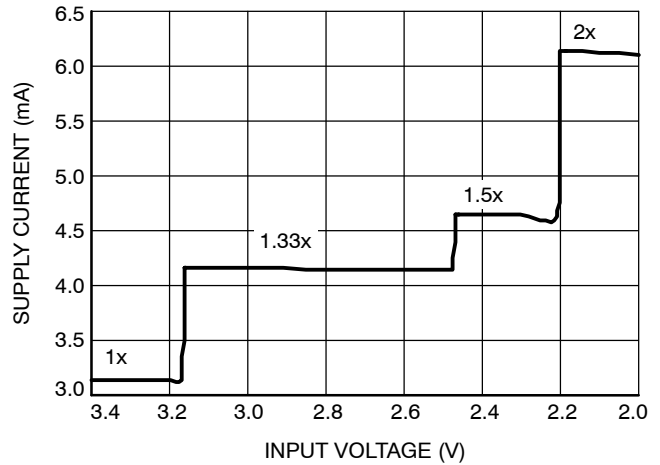

Figure 3. Total Supply Current vs. Input Voltage

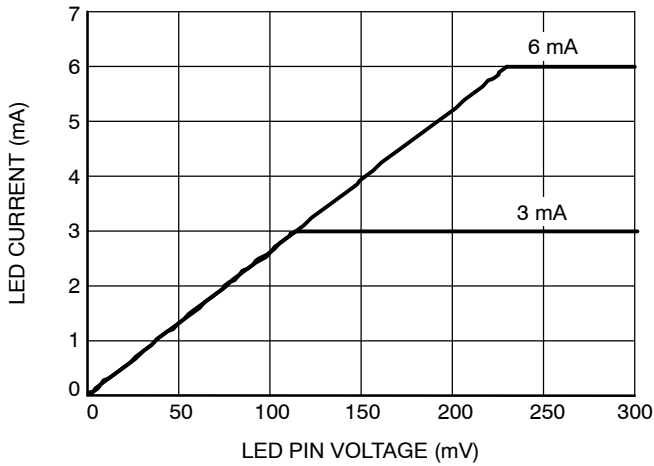

Figure 4. LED Current vs. LED Pin Voltage

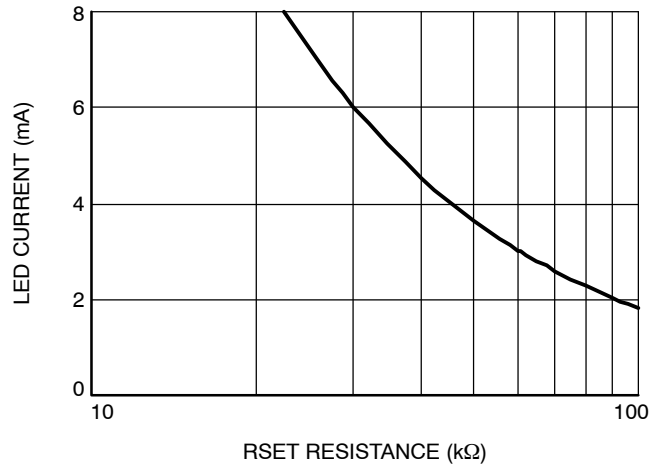

Figure 5. LED Current vs. RSET

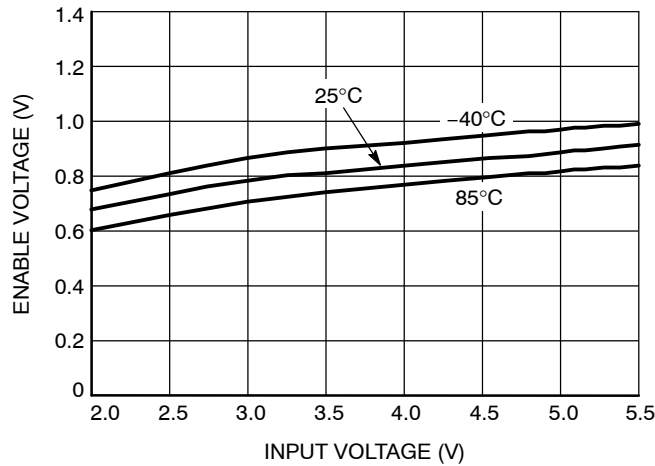

Figure 6. Enable Voltage vs. Input Voltage

TYPICAL CHARACTERISTICS

(VIN = 3 V, ILED = 3 mA, VF = 3 V, TAMB = 25°C, typical application circuit unless otherwise specified.)

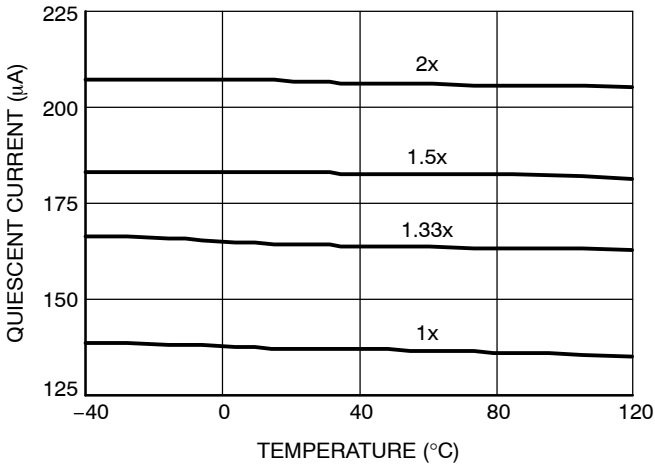

Figure 7. Quiescent Current vs. Temperature

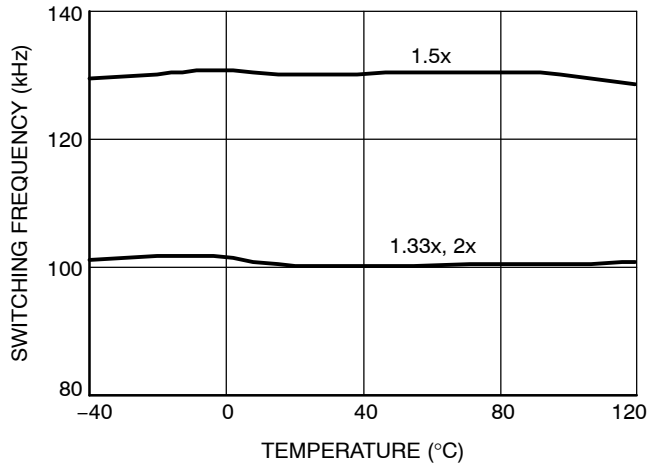

Figure 8. Switching Frequency vs. Temperature

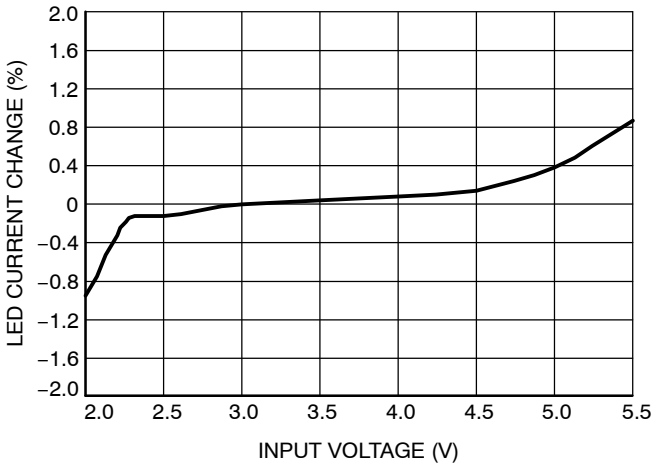

Figure 9. LED Current Change vs. Input Voltage

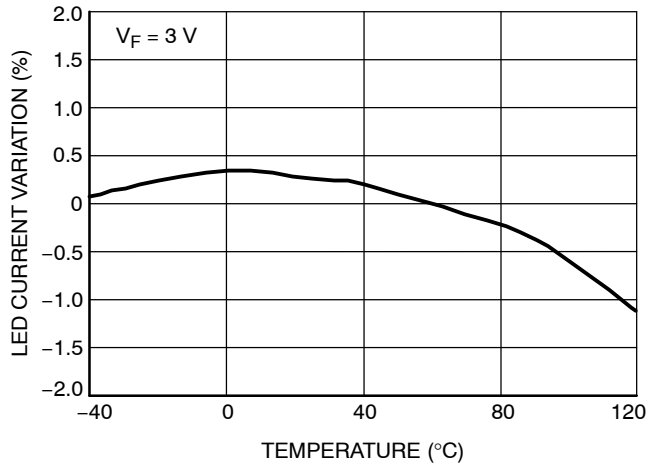

Figure 10. LED Current Change vs. Temperature

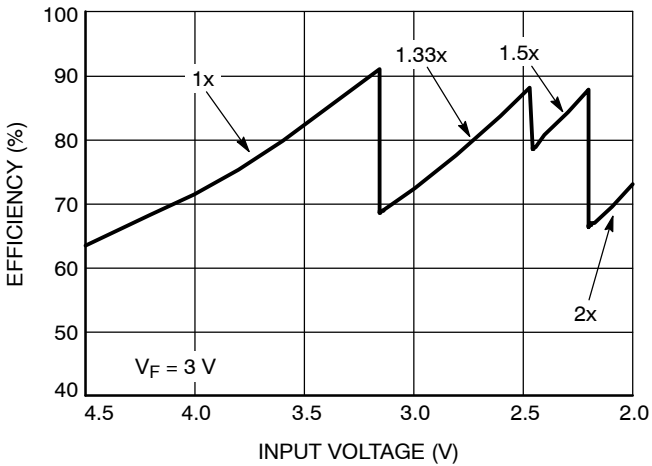

Figure 11. Efficiency vs. Input Voltage

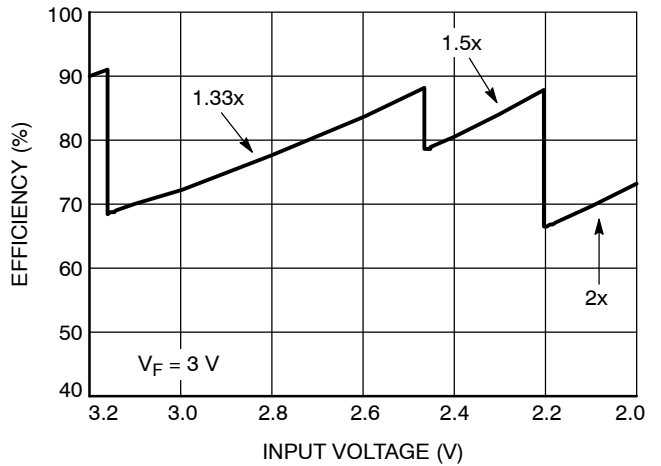

Figure 12. Efficiency vs. Lithium Coin Cell Voltage

TYPICAL CHARACTERISTICS

(VIN = 3 V, ILED = 3 mA, VF = 3 V, TAMB = 25°C, typical application circuit unless otherwise specified.)

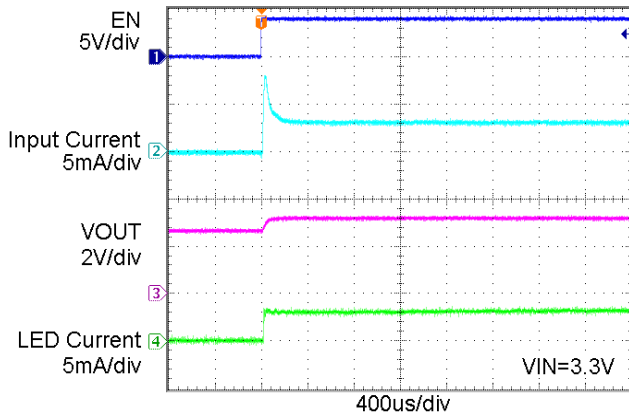

Figure 13. Power Up in 1x Mode

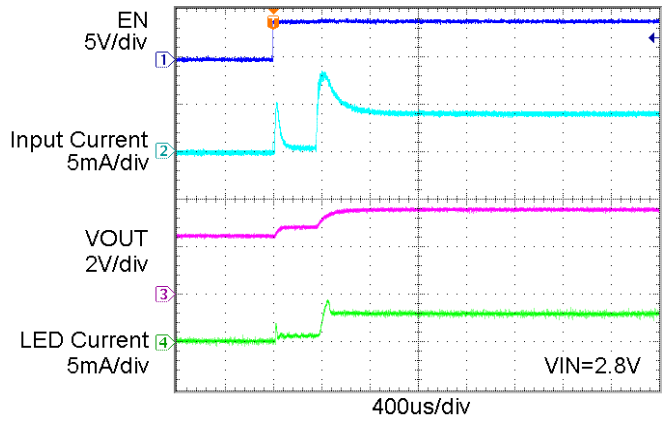

Figure 14. Power Up in 1.33x Mode

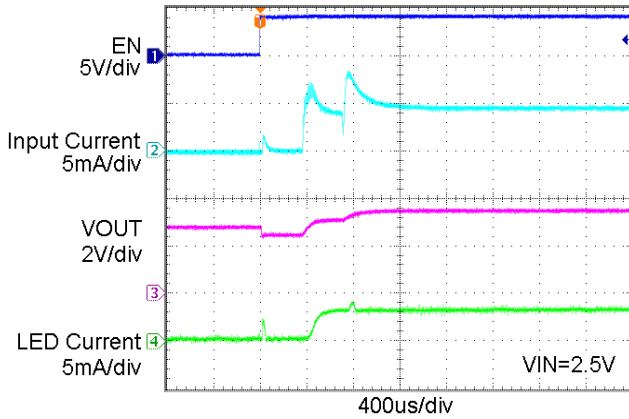

Figure 15. Power Up in 1.5x Mode

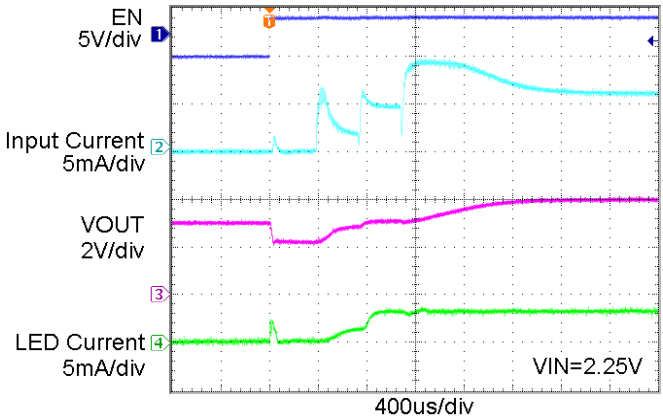

Figure 16. Power Up in 2x Mode

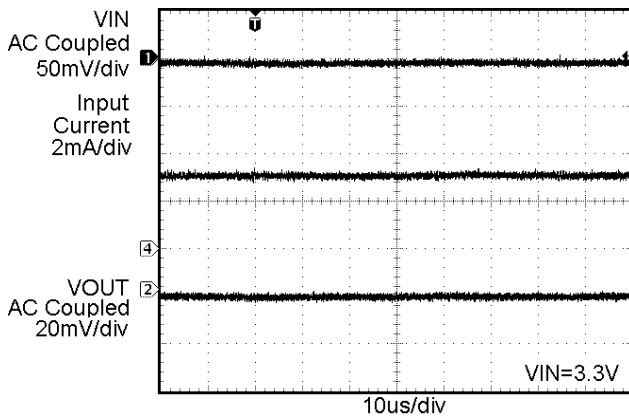

Figure 17. Operating Waveforms in 1x Mode

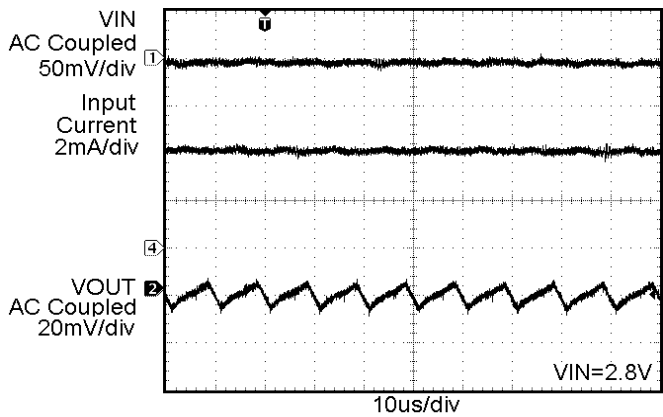

Figure 18. Operating Waveforms in 1.33x Mode

CAT3661

TYPICAL CHARACTERISTICS

(VIN = 3 V, ILED = 3 mA, VF = 3 V, TAMB = 25°C, typical application circuit unless otherwise specified.)

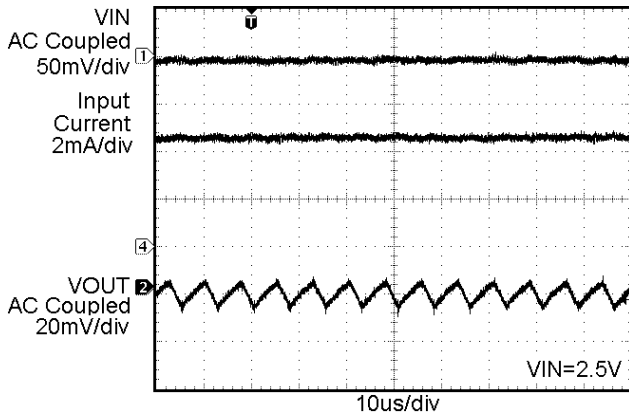

Figure 19. Operating Waveforms in 1.5x Mode

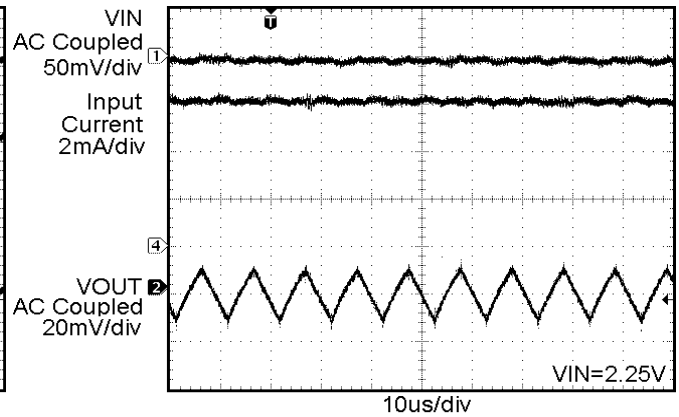

Figure 20. Operating Waveforms in 2x Mode

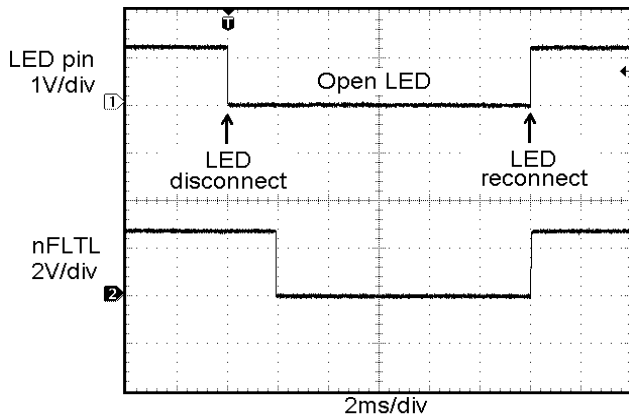

Figure 21. Open LED

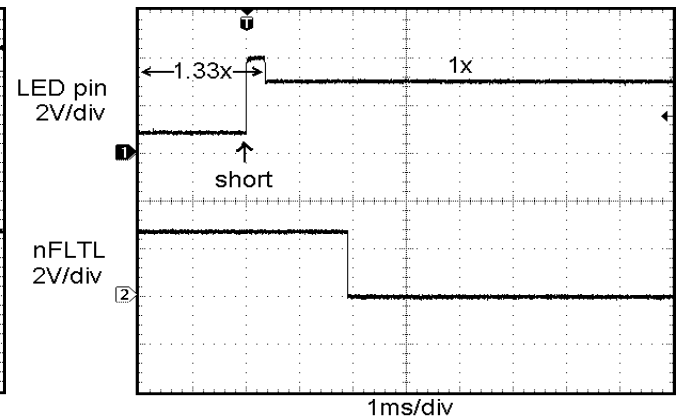

Figure 22. LED Pin Shorted to VOUT

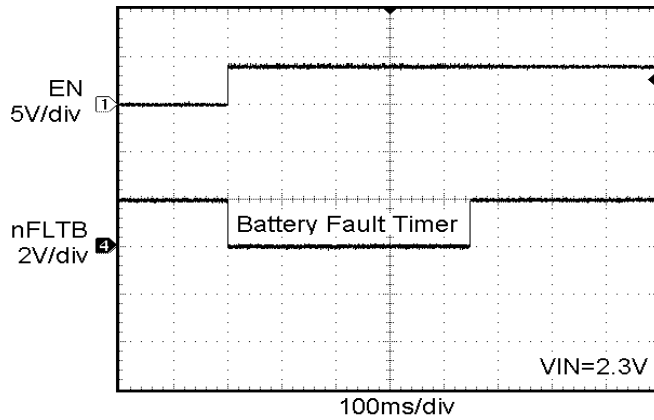

Figure 23. Enable with Low Battery

Table 5. PIN DESCRIPTION

Pin No.	Pin Name	Description
1	RSET	Connect resistor RSET to set the LED current
2	nFLTB	Battery Fault output, Open drain output. (Active low)
3	nFLTL	LED Fault output, Open drain output. (Active low)
4	EN	Device enable (Active high)
5	LED	LED cathode terminal
6	NC	Not connected inside the package
7	NC	Not connected inside the package
8	VOUT	Charge pump output connected to the LED anodes
9	C2-	Bucket capacitor 2 Negative terminal
10	C2+	Bucket capacitor 2 Positive terminal
11	C1+	Bucket capacitor 1 Positive terminal
12	C1-	Bucket capacitor 1 Negative terminal
13	VIN	Positive supply connection to battery
14	ADJH	Battery trip point threshold adjust high
15	ADJL	Battery trip point threshold adjust low
16	GND	Ground supply connection
TAB	GND	Connect to GND on the PCB

Pin Functions

VIN is the supply pin for the device. A small 1 μ F ceramic bypass capacitor is required between the VIN pin and ground near the device.

EN is the device enable pin. Levels of logic high and logic low are set at 1.3 V and 0.4 V respectively to enable interface to low voltage controllers. EN pin is compatible with voltages higher than VIN.

VOUT is the charge pump output that is connected to the LED anodes. A small 1 μ F ceramic bypass capacitor is required between the VOUT pin and ground near the device.

GND is the ground reference for the charge pump. This pin must be connected to the ground plane on the PCB.

C1+, C1- are connected to each side of the ceramic bucket capacitor C1.

C2+, C2- are connected to each side of the ceramic bucket capacitor C2.

LED provides the internal regulated current source for the LED cathode. This pin enters high-impedance ‘zero’ current state whenever the device is placed in shutdown mode.

TAB is the exposed pad underneath the package. For best thermal performance, the tab should be soldered to the PCB and connected to the ground plane.

RSET is connected to a resistor (RSET) to set the full scale current for the LEDs. The voltage at this pin regulated to 0.6 V. The ground side of the external resistor should be star connected back to the GND of the PCB. In shutdown mode, RSET becomes high impedance.

nFLTL is an active low open-drain output that provides a fault flag for an open/short LED condition. If used, this pin requires a pull-up resistor.

nFLTB is an active low open-drain output that provides a fault flag for a low battery condition. If used, this pin requires a pull-up resistor. nFLTB and nFLTL can be shorted together for one Fault output (ORed function).

ADJH is an external connection to the top of the low battery sense resistor divider network. This pin should be shorted to VIN if a trip point of 2.4 V is required.

ADJL is an external connection to the bottom of the low battery sense resistor divider network. This pin should be shorted to GND if a trip point of 2.4 V is required.

CAT3661

Block Diagram

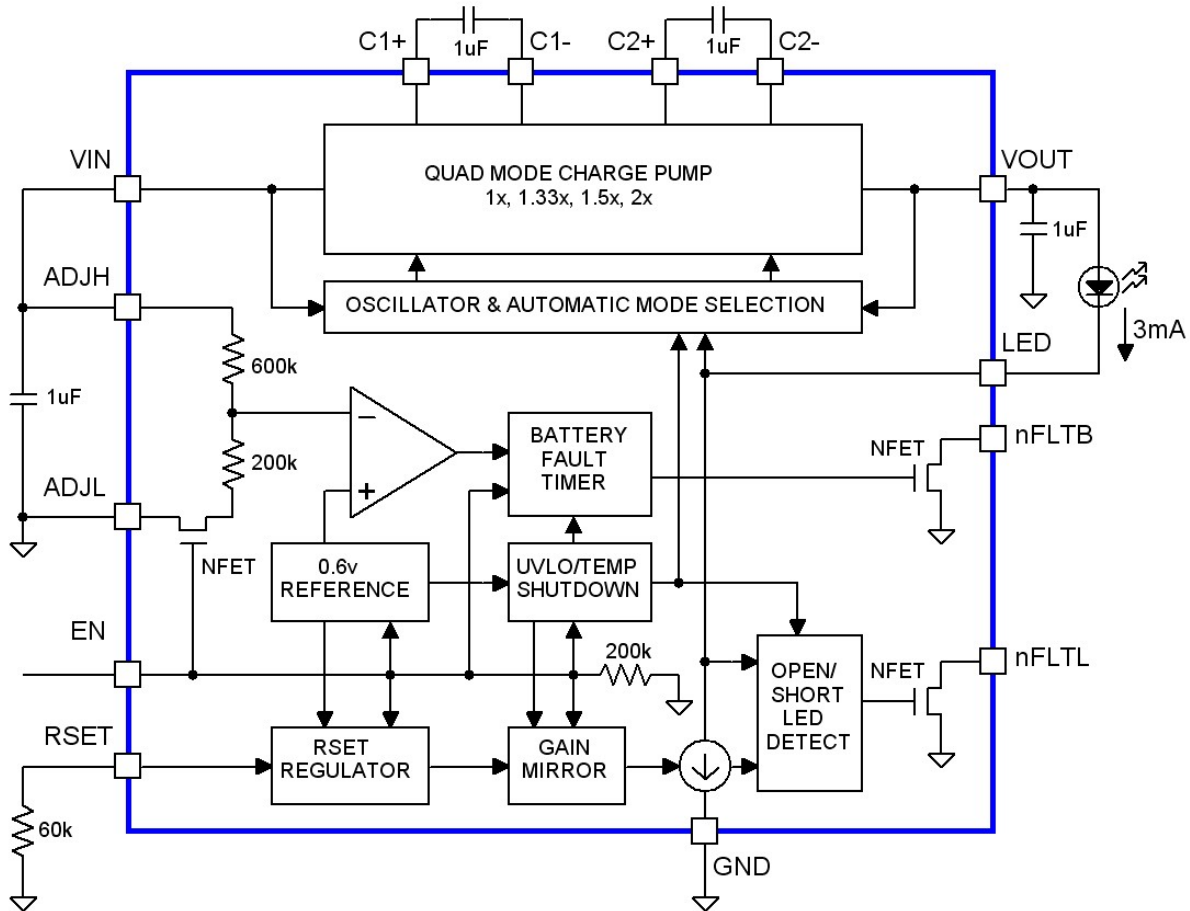

Figure 24. CAT3661 Functional Block Diagram

Basic Operation

At power-up, the CAT3661 starts operating in 1x mode where the output will be approximately equal to the input supply voltage (less any internal voltage losses). If the output voltage is sufficient to regulate the LED current, the device remains in 1x operating mode.

If the input voltage is insufficient or falls to a level where the LED regulated current cannot be maintained, the device automatically switches into 1.33x mode (after a fixed delay time of about 400 μ s). In 1.33x mode, the output voltage is approximately equal to 1.33 times the input supply voltage (less any internal voltage losses).

This sequence repeats in the 1.33x and 1.5x mode until the driver enters the 2x mode. In 1.5x mode, the output voltage is approximately equal to 1.5 times the input supply voltage. While in 2x mode, the output is approximately equal to 2 times the input supply voltage.

If the device detects a sufficient input voltage is present to drive the LED current in 1x mode, it will change automatically back to 1x mode. This only applies for changing back to the 1x mode. The difference between the input voltage when exiting 1x mode and returning to 1x

mode is called the 1x mode transition hysteresis (V_{HYS}) and is about 300 mV.

LED Current Setting

The current flowing out of the RSET pin to ground mirrors the current in the LED channel with a gain of 300. The LED current can be adjusted from 0.1 mA to 5 mA. Connecting a resistor between RSET and GND allows a reference current to flow due to the voltage on the RSET pin being regulated to 0.6 V. The internal gain of the current mirror is 300. It is possible to calculate the current in the LED channel by the following equation:

$$I_{LED} = \frac{0.6 \text{ V}}{R_{SET}} \times 300$$

Adjustable Battery Indicator

The CAT3661 contains an adjustable low battery indicator that is active when the device is enabled. If the voltage on the internal resistor divider trip point node is less than V_{ADJ} (0.6 V), the nFLTB output is driven low and remains low for 500 ms after the EN pin is driven high. The CAT3661 will still function normally below this voltage

CAT3661

range. Extra external resistors can be added to the top or bottom of the internal resistor divider network to alter the divider ratio gain factor. The low battery indicator trip point can be calculated by the following formula:

$$V_{LB} = V_{ADJ} \times G_{ADJ}$$

V_{LB} = Low Battery Voltage Trip Point

V_{ADJ} = Low Battery Comparator Trip point (0.6 V)

G_{ADJ} = Resistor Divider Gain (4 internally)

To obtain a low battery trip point of 2.4 V, the ADJH pin is shorted to VIN, and the ADJL pin is tied to GND.

To increase the low battery trip point, insert a resistor between ADJH and VIN. To consequently lower the low battery trip point, insert a resistor between ADJL and GND. The following formula shows how to calculate the modified resistor divider gain:

$$G_{ADJM} = \frac{R_{ADJ} + R_H}{(R_{ADJ}/G_{ADJ}) + R_L}$$

G_{ADJM} = Modified resistor divider gain

R_{ADJ} = Total resistance of divider (800 kΩ typ.)

R_H = High external resistor (ADJH to VIN)

R_L = Low external resistor (ADJL to GND)

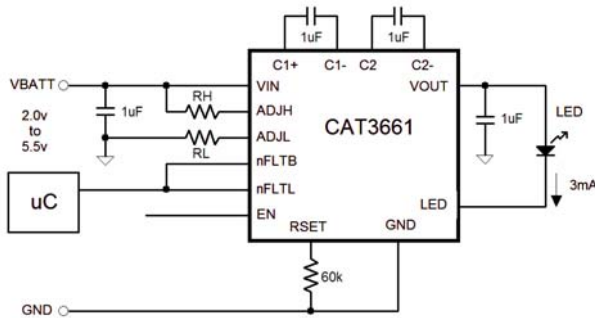

Figure 25. Application Circuit with R_H & R_L

The resistance required for a certain trip point voltage can be calculated by rearranging the above equations with respect to R_H or R_L .

For $V_{LB} > 2.4$ V, use $R_L = 0 \Omega$ and

$$R_H (\text{k}\Omega) \cong 200 (V_{LB}/0.6 - 1) - 600$$

For $V_{LB} < 2.4$ V, use $R_H = 0 \Omega$ and

$$R_L (\text{k}\Omega) \cong 600 (0.6/(V_{LB} - 0.6)) - 200$$

Figure 26 shows the external resistor value for low battery voltage trip points (V_{LB}) between 2 V and 3.2 V. For V_{LB} above 2.4 V, $R_L = 0 \Omega$. For V_{LB} below 2.4 V, $R_H = 0 \Omega$.

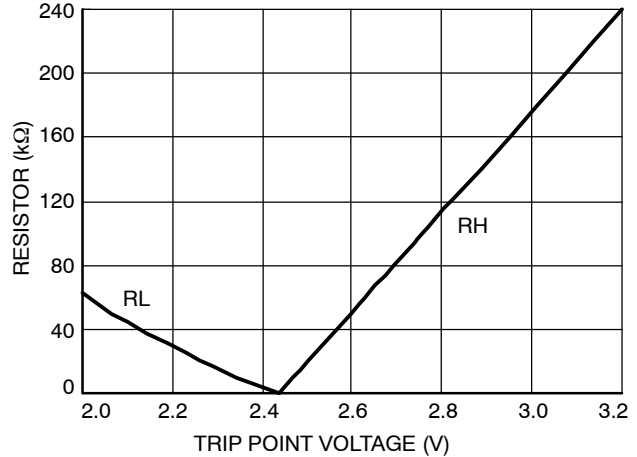

Figure 26. V_{LB} vs. R_H & R_L

The low battery trip point does not operate for adjustments below 2.0 V VIN.

The inclusion of the ADJH pin allows monitoring of supplies other than the supply to the CAT3661. Simply connect ADJH pin directly to the supply to be monitored and the low battery indicator will function as normal when the device is enabled. When EN is low, no current will flow in the resistor divider network allowing 'zero' current shutdown mode.

Under Voltage Lockout

If the voltage on VIN is less than V_{UVLO} threshold, the nFLTBL output is driven low and the device enters a low power state where the LED output is off.

When the device is in shutdown (EN low), the nFLTBL pin will float high to 'zero' current state.

Protection Mode

Open LED Protection

An LED is deemed open circuit if the LED current sink is unable to regulate the LED channel to the programmed current for greater than 2 ms. The driver will sense this condition and the nFLTL pin will be driven low. The device will be placed into a standby-mode until the Open LED condition is removed or the device is re-enabled (EN goes low then high again) at which point the Open LED condition will be evaluated.

Short LED Protection

An LED is deemed to be short circuit if the difference between VOUT pin and LED pin is less than 1.0 V when the programmed current is driven in the channel for greater than 2 ms. If this is the case, then the LED sink is turned off and a 5 µA test current is placed in the channel. The nFLTL pin is driven low. Once the short condition is removed normal operation will resume and nFLTL will be floated high.

When the device is shutdown (EN low), the nFLTL pin will float high to ‘zero’ current state.

Input Current Limiting

The charge pump contains an input current limit circuit that limits the current through the input pin. The current is limited to 1000 times (G_{I_MAX}) the current flowing in RSET. Use the following formula:

$$I_{MAX} = \frac{0.6 V}{R_{SET}} \times 1000$$

The input current limit insures the battery is never loaded with more than 3.3 times the LED current during a short circuit condition, Charge Pump startup condition or charge pump mode change. The device will only ever use a maximum of 2 times the programmed LED current plus quiescent operating current when in normal 2x mode of operation.

Lithium coin cell batteries have high internal resistances so a robust current limit is a very important feature of the device to prevent large voltage droops from triggering device resets during operation of the CAT3661.

Over Voltage, Over Temperature Protection

As soon as VOUT is pumped above 4.5 V, the driver will stop advancing modes if the LED sink is not in regulation. This indicates a possible Open LED condition and stops the device from seeing excessive voltages on the output pin greater than the absolute maximum ratings for VOUT. An additional fail safe over-voltage detector prevents the VOUT output from ever exceeding 6.5 volts.

If the die temperature exceeds +150°C, the driver will enter a thermal protection shutdown mode and the LED will be turned off. The nFLTL pin will be driven low. Once the device temperature drops by about 20°C, the device will resume normal operation and nFLTL will be floated high.

External Components

The driver requires four external 1 µF ceramic capacitors for decoupling input, output, and for the charge pump “fly” capacitors. Capacitors type X5R and X7R are recommended for the LED driver application. In all charge pump modes, the input current ripple is kept very low by design and an input bypass capacitor of 1 µF is sufficient. In 1x mode, the device operates in linear mode and does not introduce switching noise back onto the supply.

LED Selection

LEDs with forward voltages (V_F) ranging from 1.3 V to 4.2 V may be used. Selecting LEDs with lower V_F is recommended in order to improve the efficiency by keeping the driver in 1x mode longer as the battery voltage decreases.

For example, if a white LED with a V_F of 3.3 V is selected over one with V_F of 3.5 V, the driver will stay in 1x mode to a lower supply voltage of 0.2 V. This helps improve the efficiency and extends battery life.

CAT3661

PACKAGE DIMENSIONS

TQFN16, 3x3
CASE 510AD-01
ISSUE A

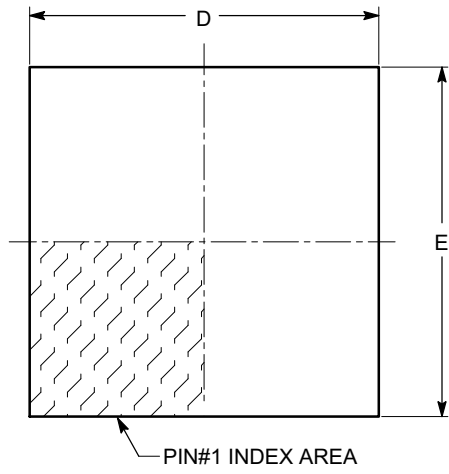

TOP VIEW

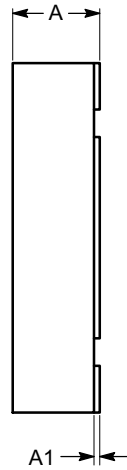

SIDE VIEW

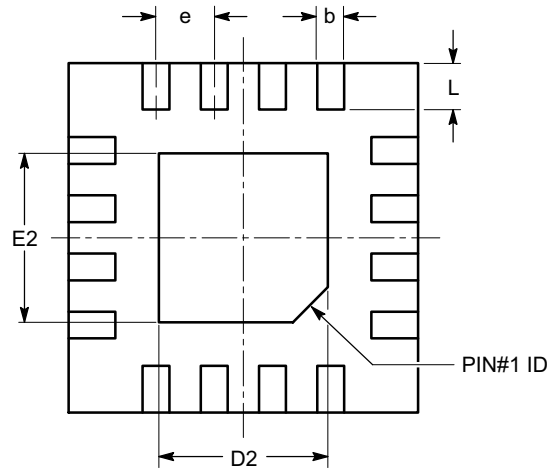

BOTTOM VIEW

SYMBOL	MIN	NOM	MAX
A	0.70	0.75	0.80
A1	0.00	0.02	0.05
A3	0.20 REF		
b	0.18	0.25	0.30
D	2.90	3.00	3.10
D2	1.40	---	1.80
E	2.90	3.00	3.10
E2	1.40	---	1.80
e	0.50 BSC		
L	0.30	0.40	0.50

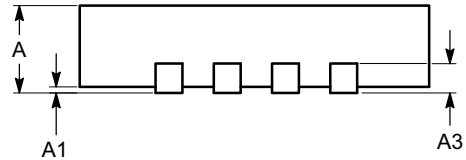

FRONT VIEW

Notes:

- (1) All dimensions are in millimeters.
- (2) Complies with JEDEC MO-220.

CAT3661

Example of Ordering Information (Note 5)

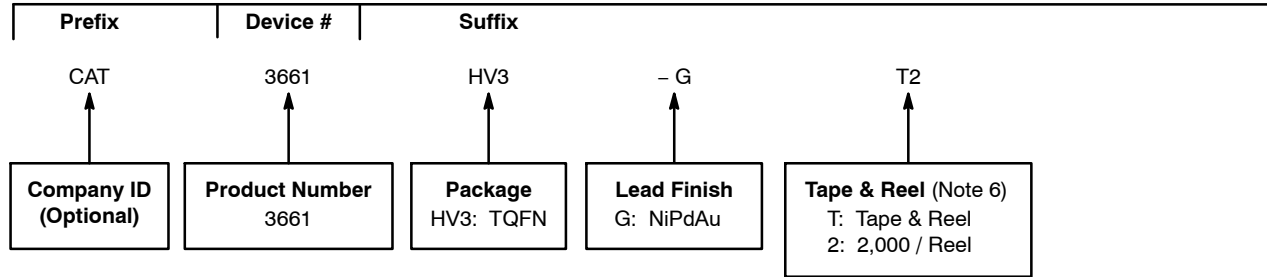

3. All packages are RoHS-compliant (Lead-free, Halogen-free).
4. The standard lead finish is NiPdAu.
5. The device used in the above example is a CAT3661HV3-GT2 (TQFN, NiPdAu, Tape & Reel, 2,000/Reel).
6. For information on tape and reel specifications, including part orientation and tape sizes, please refer to our Tape and Reel Packaging Specifications Brochure, BRD8011/D.

Quad-Mode is a registered trademark of Semiconductor Components Industries, LLC.

ON Semiconductor and  are registered trademarks of Semiconductor Components Industries, LLC (SCILLC). SCILLC reserves the right to make changes without further notice to any products herein. SCILLC makes no warranty, representation or guarantee regarding the suitability of its products for any particular purpose, nor does SCILLC assume any liability arising out of the application or use of any product or circuit, and specifically disclaims any and all liability, including without limitation special, consequential or incidental damages. "Typical" parameters which may be provided in SCILLC data sheets and/or specifications can and do vary in different applications and actual performance may vary over time. All operating parameters, including "Typicals" must be validated for each customer application by customer's technical experts. SCILLC does not convey any license under its patent rights nor the rights of others. SCILLC products are not designed, intended, or authorized for use as components in systems intended for surgical implant into the body, or other applications intended to support or sustain life, or for any other application in which the failure of the SCILLC product could create a situation where personal injury or death may occur. Should Buyer purchase or use SCILLC products for any such unintended or unauthorized application, Buyer shall indemnify and hold SCILLC and its officers, employees, subsidiaries, affiliates, and distributors harmless against all claims, costs, damages, and expenses, and reasonable attorney fees arising out of, directly or indirectly, any claim of personal injury or death associated with such unintended or unauthorized use, even if such claim alleges that SCILLC was negligent regarding the design or manufacture of the part. SCILLC is an Equal Opportunity/Affirmative Action Employer. This literature is subject to all applicable copyright laws and is not for resale in any manner.

PUBLICATION ORDERING INFORMATION

LITERATURE FULFILLMENT:
Literature Distribution Center for ON Semiconductor
P.O. Box 5163, Denver, Colorado 80217 USA
Phone: 303-675-2175 or 800-344-3860 Toll Free USA/Canada
Fax: 303-675-2176 or 800-344-3867 Toll Free USA/Canada
Email: orderlit@onsemi.com

N. American Technical Support: 800-282-9855 Toll Free
USA/Canada
Europe, Middle East and Africa Technical Support:
Phone: 421 33 790 2910
Japan Customer Focus Center
Phone: 81-3-5773-3850

ON Semiconductor Website: www.onsemi.com

Order Literature: <http://www.onsemi.com/orderlit>

For additional information, please contact your local Sales Representative

CAT3661/D