

10 9 8 7 6 5 4 3 2 1

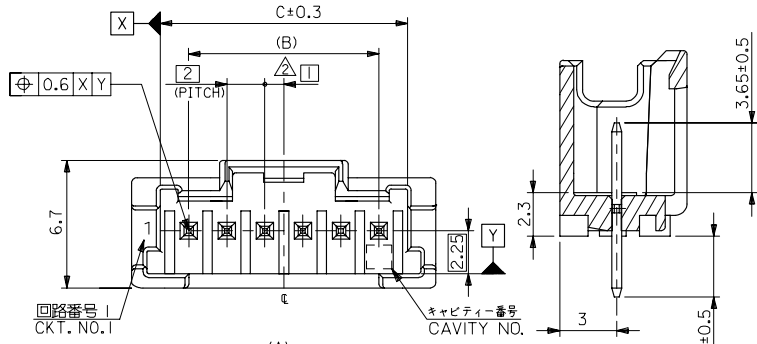

NOTE
 1. 嵌合相手：51382シリーズ
 △ 偶数極（列）に適用。
 3. キングは両外側の位置に付加。
 △ 製品番号 MATERIAL NO.

55932-****
 極数 CIRCUIT SIZE

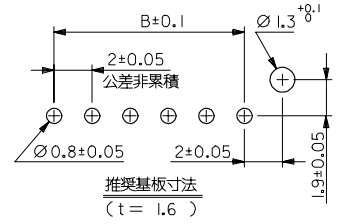

推奨基板寸法
 (t = 1.6)

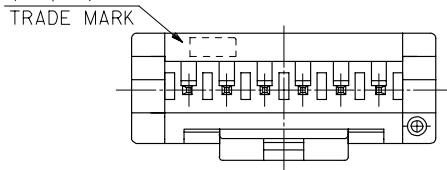
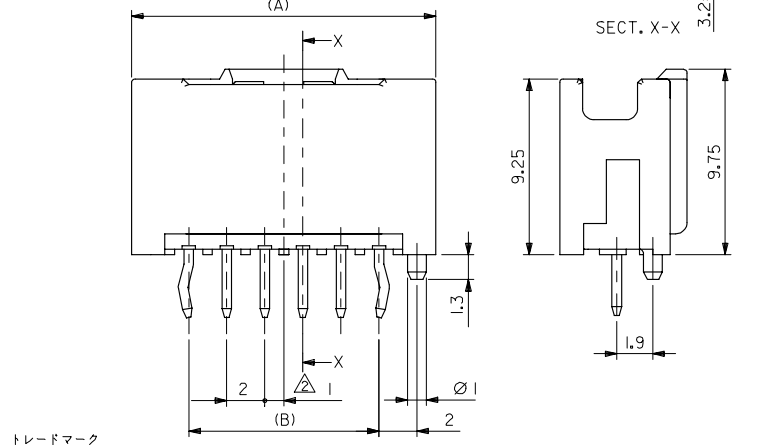

色 COLOR	
10	自然色 (白) NATURAL (WHITE)
11	黒 BLACK
12	赤 RED
13	黄 YELLOW
14	青 BLUE
15	桃 PINK
16	緑 GREEN
17	茶 BROWN
18	橙 ORANGE
19	紫 VIOLET
41	灰 GRAY
43	蛍光黄 FLUORESCENCE YELLOW
44	水 PALE BLUE
46	黄緑 YELLOWISH GREEN

31	28	34	55932-15**	15
29	26	32	55932-14**	14
27	24	30	55932-13**	13
25	22	28	55932-12**	12
23	20	26	55932-11**	11
21	18	24	55932-10**	10
19	16	22	55932-09**	9
17	14	20	55932-08**	8
15	12	18	55932-07**	7
13	10	16	55932-06**	6
11	8	14	55932-05**	5
9	6	12	55932-04**	4
7	4	10	55932-03**	3
5	2	8	55932-02**	2
C	B	A	MATERIAL NO. CKT.	

MATERIAL
 ピン : 黄銅、錫メッキ
 ハウジング : PBT

REVISED IEC NO. : J2006-3014 2006/03/28 DRAWN: H. NABEI 2006/05/08 CHKD: K. YODA 2006/05/08 APPR: N. KITA 2006/05/08 H	GENERAL TOLERANCES (UNLESS SPECIFIED)		DIMENSION STYLE MM ONLY		SCALE ---	DESIGN UNITS METRIC	THIRD ANGLE PROJECTION
	10 UNDER	±0.2	DRAWN BY T. NITSU	DATE '02/02/08	TITLE 2.0 W/B SINGLE CONN. PLUG HOUSING ASS'Y ST-LEAD FREE-		
	10 OVER 30 UNDER	±0.25	CHECKED BY K. ASAKAWA	DATE '03/06/12	MOLEX INCORPORATED		
	30 OVER	±0.3	APPROVED BY T. YAMAGUCHI	DATE '03/06/12	DOCUMENT NO. SD-55932-002		
	ANGULAR ±3 °	DRAFT WHERE APPLICABLE MUST REMAIN WITHIN DIMENSIONS		SEE CHART		SHEET NO. 1 OF 2	
SIZE A3				THIS DRAWING CONTAINS INFORMATION THAT IS PROPRIETARY TO MOLEX INCORPORATED AND SHOULD NOT BE USED WITHOUT WRITTEN PERMISSION			

10 9 8 7 6 5 4 3 2 1

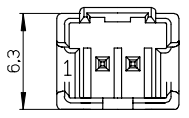
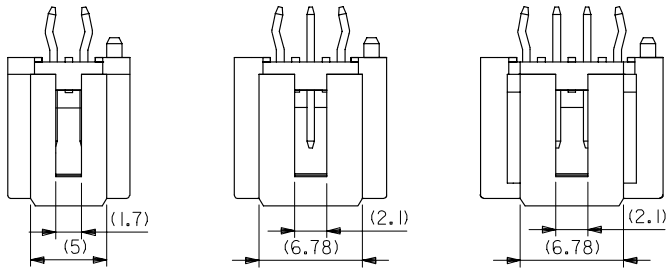

2 CIRCUIT

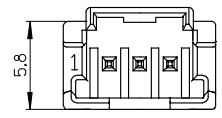

3 CIRCUIT

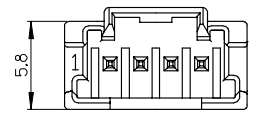

4 CIRCUIT 以上

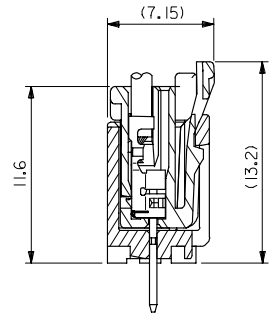

嵌合断面図

MODEL NO. : 55932-****

REVISED EC NO. J2006-3014 DRW:HWABEI 2006/03/28 CHK:KTOYODA 2006/05/08 APPR:NIKIITA 2006/05/08 H	GENERAL TOLERANCES (UNLESS SPECIFIED)		DIMENSION STYLE MM ONLY		SCALE ---	DESIGN UNITS METRIC	THIRD ANGLE PROJECTION
	10 UNDER	±0.2	DRAWN BY T.NIITSU	DATE '02/02/08	TITLE 2.0 W/B SINGLE CONN. PLUG HOUSING ASS'Y ST -LEAD FREE-		
	10 OVER 30 UNDER	±0.25	CHECKED BY K.ASAKAWA	DATE '03/06/12			
	30 OVER	±0.3	APPROVED BY T.YAMAGUCHI	DATE '03/06/12	MOLEX INCORPORATED		
	ANGULAR	±3 °	MATERIAL NO.	SEE CHART	DOCUMENT NO. SD-55932-002	SHEET NO. 2 OF 2	
DRAFT WHERE APPLICABLE MUST REMAIN WITHIN DIMENSIONS		SIZE A3			THIS DRAWING CONTAINS INFORMATION THAT IS PROPRIETARY TO MOLEX INCORPORATED AND SHOULD NOT BE USED WITHOUT WRITTEN PERMISSION		