

10 9 8 7 6 5 4 3 2 1

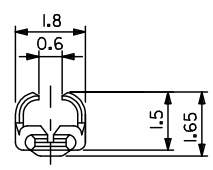
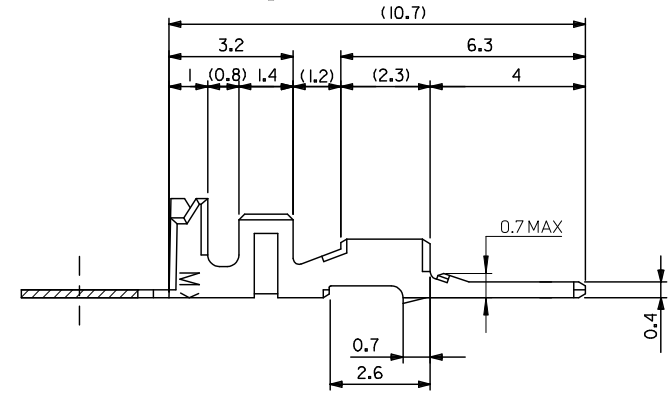
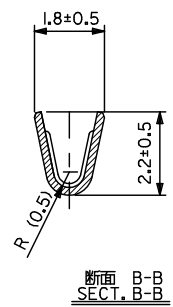
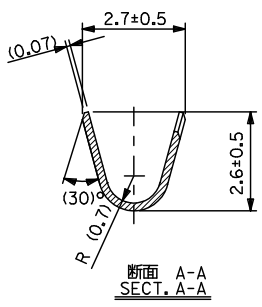
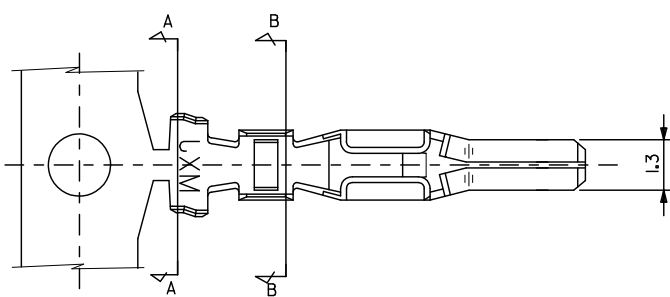

注記
NOTES

- 適合ハウジング アッセンブリ; 52266-***
APPLICABLE HS'G ASS'Y; 52266-***
- 嵌合相手; 50148-8*00
MATES WITH; 50148-8*00

50147-8100	バラ状 LOOSE
50147-8000	連鎖状 CHAIN
製品番号 ENG.NO.	端子形状 FORM

材料 MATERIAL	リン青銅 錫メッキ(+0.2) PHOSPHOR BRONZE TIN PLATING(+0.2)
適用電線範囲 WIRE RANGE	AVSS-0.3 AVSS-0.5 CAVS-0.3 CAVS-0.5
被覆外径 INS. RANGE	φ1.4-1.7

REVISED & REDRAWN EC NO: JTR2010-0004 DRAWN: MISHIBATA 2009/07/28 CHKD: AITO 2009/07/28 APPR: MAYAMOTO 2009/07/28	GENERAL TOLERANCES (UNLESS SPECIFIED)		DIMENSION STYLE MM ONLY		SCALE 10:1	DESIGN UNITS METRIC	THIRD ANGLE PROJECTION
	10 UNDER	±0.3	DRAWN BY M. SANO	DATE 1991/11/17	TITLE 2.5 MINI SPLASH PROOF CONN. CRIMP PIN.		
	10 OVER 30 UNDER	±0.25	CHECKED BY M. SAKANO	DATE 1992/18/16			
	30 OVER	±0.2	APPROVED BY M. ENOMOTO	DATE 1992/18/16	MOLEX INCORPORATED SD-50147-8*00		
ANGULAR	±3 °	MATERIAL NO. SEE CHART		DOCUMENT NO.			
DRAFT WHERE APPLICABLE MUST REMAIN WITHIN DIMENSIONS			THIS DRAWING CONTAINS INFORMATION THAT IS PROPRIETARY TO MOLEX INCORPORATED AND SHOULD NOT BE USED WITHOUT WRITTEN PERMISSION				

tb_frame_A3_J_AM_S
Rev. E 2006/04/15

EN-02DA(021)

ENG. NO. SD-50147-8*00
EDP NO.

MM DIMENSIONS IN METRIC DO NOT SCALE DRAWING

8 7 6 5 4 3 2 1

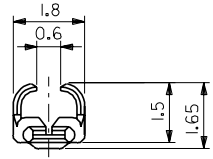
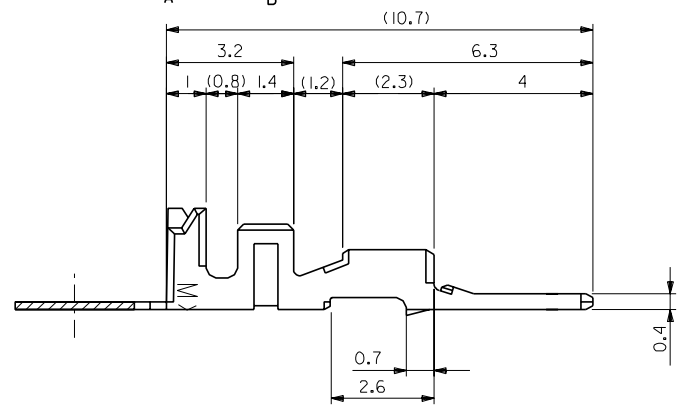
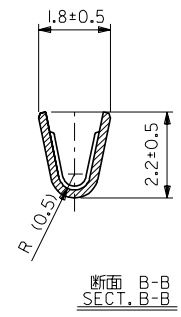
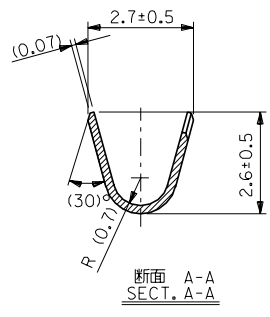
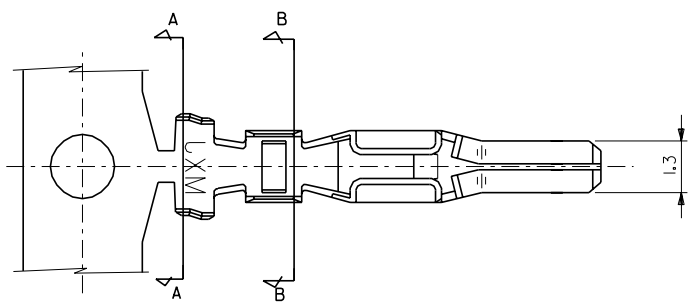

注記
NOTES

- 適合ハウジング アッセンブリ; 52266-***
APPLICABLE HS'G ASS'Y; 52266-***
- 嵌合相手; 50148-8*00
MATES WITH; 50148-8*00

50147-8100	バラ状 LOOSE
50147-8000	連鎖状 CHAIN
製品番号 ENG.No.	端子形状 FORM

角度 ANGLE		±3°			材料 MATERIAL リン青銅 鍍メッキ (t=0.2) PHOSPHOR BRONZE TIN PLATING (t=0.2)		MOLEX-JAPAN CO.,LTD. 日本モレックス株式会社	
30以上 OVER	±0.3	A	変更 REVISED (J20708)	92/8/6	適用電線範囲 WIRE RANGE	AVSS-0.3 AVSS-0.5 CAVS-0.3 CAVS-0.5	EDP NO.	
10以上 未満 OVER 30 UNDER	±0.25	O	新案作成 PROPOSED (J10601)	91/8/20	被覆外径 INS. RANGE	φ 1.4-1.7	ENG. NO.	REV
10未満 UNDER	±0.2	記号 LTR	変更内容 REVISION RECORD	DR. CHK. DATE	DRAWN BY M.SAKANO	91/11/17	SD-50147-8*00	A
一般公差 GENERAL TOLERANCES					APPR'D BY M.ENOMOTO	92/8/6	TITLE 名称 2.5 MINI SPLASH PROOF CONN. CRIMP PIN.	

REVISION RECORD

REVISE ONLY ON CAD SYSTEM

THIS DRAWING CONTAINS INFORMATION THAT IS PROPRIETARY TO MOLEX/JAPAN AND SHOULD NOT BE USED WITHOUT WRITTEN PERMISSION
本図面は日本モレックス(株)の所有する情報を含むもので 当社の許可なく複製を禁止する。

MXJ-8