

New

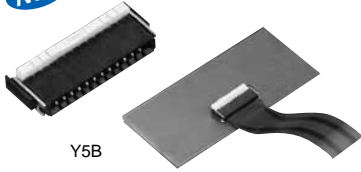

Y5B

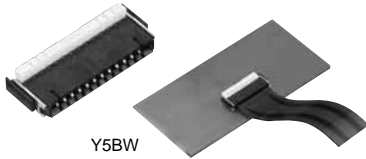

Y5BW

Low profile and space saving body of 1.0 mm high and 3.20 mm deep (3.70 mm including the lever)
Y5B and Y5BW can have a minimum of four and two contacts respectively, contributing to the miniaturization and thickness reduction of target equipment.

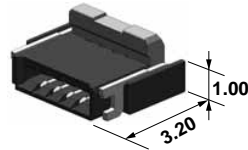

Unit: mm

4 contacts (Y5B: minimum)

Compliance with RoHS Directive

FEATURES

- Low profile, space saving back lock type with improved lever operability
- Mechanical design freedom achieved by top and bottom double contacts
- Low profile, space saving design with a wide selection, including a type with a small number of contacts

- Wiring patterns can be located underneath the connector.
- Man-hours for assembly can be reduced by delivering the connectors with their levers opened.
- Y5BW features advanced functionality, including a structure to temporarily hold the FPC and a higher holding force.

The FPC holding contacts located on both ends of the connector facilitate positioning of FPC and further enhance the FPC holding force.

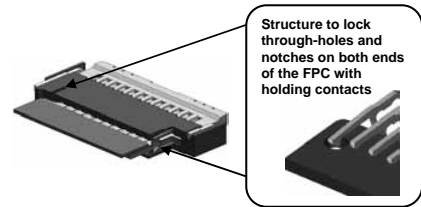

Applicable FPC shapes



With notches



With through-holes

- (1) The holding contacts lock the FPC by its through-holes or notches, allowing users to confirm the completion of the FPC insertion operation.
- (2) The inserted FPC can be temporarily held until the lever is closed.
- (3) When the lever is closed, the holding contacts lock the FPC by its through-holes and notches, enhancing the FPC holding force.

APPLICATIONS

A wide range of digital equipment, including mobile phones, PCs, DSCs, and DVCs. Ideal for their touch panels and LCD backlights, which require connectors with a small number of contacts.

ORDERING INFORMATION

AYF 5 3 [] [] [] 5

53: FPC Connector 0.5 mm pitch (Back lock)

Number of contacts (2 digits)

Function

3: Top and bottom double contacts (Y5B)

6: Top and bottom double contacts, lock holding type (Y5BW)

Surface treatment (Contact portion / Terminal portion)

5: Au plating/Au flash plating (Ni barrier)

PRODUCT TYPES

Height	Y5B		Y5BW		Packing	
	Number of contacts	Part number	Number of contacts	Part number	Inner carton (1-reel)	Outer carton
1.0 mm	4	AYF530435	2	AYF530265	5,000 pieces	10,000 pieces
	6	AYF530635	4	AYF530465		
	8	AYF530835	6	AYF530665		
	10	AYF531035	8	AYF530865		
	12	AYF531235	10	AYF531065		
	24	AYF532435	22	AYF532265		
	50	AYF535035	48	AYF534865		

Notes: 1. Order unit;

For mass production: in 1-inner carton (1-reel) units

Samples for mounting check: in 50-connector units. Please contact our sales office.

2. Please contact are sales office for connectors having a number of contacts other than those listed above.

SPECIFICATIONS

1. Characteristics

	Item	Specifications	Conditions
Electrical characteristics	Rated current	0.5A/contact	
	Rated voltage	50V AC/DC	
	Insulation resistance	Min. 1,000MΩ (initial)	Using 250V DC megger (applied for 1 min.)
	Breakdown voltage	250V AC for 1 min.	No short-circuiting or damage at a detection current of 1 mA when the specified voltage is applied for one minute.
	Contact resistance	Max. 80mΩ	Based on the contact resistance measurement method specified by JIS C 5402.
Mechanical characteristics	FPC holding force	Y5B: Min. 0.2N/contacts × contacts (initial) Y5BW: Min. 0.2N/contacts × contacts + 2.0N (initial)	Measurement of the maximum force applied until the inserted compatible FPC is pulled out in the insertion axis direction while the connector lever is closed
	Contact holding force	Min. 0.2N/contacts	Y5B: Measuring the maximum force. As the contact is axially pull out. Y5BW: Measuring the maximum force. As the contact and holding terminal are axially pull out.
	Soldering terminal holding force	Min. 0.2N/contacts	Measuring the maximum force. As the soldering terminal is axially pull out.
Environmental characteristics	Ambient temperature	-55°C to +85°C	
	Storage temperature	-55°C to +85°C (product only) -40°C to +50°C (emboss packing)	No freezing at low temperatures. No dew condensation.
	Thermal shock resistance (with FPC inserted)	5 cycles, insulation resistance min. 100MΩ, contact resistance max. 100mΩ	Sequence 1. -55 [±] 3°C, 30 minutes 2. ~, Max. 5 minutes 3. 85 [±] 3°C, 30 minutes 4. ~, Max. 5 minutes
	Humidity resistance (with FPC inserted)	120 hours, insulation resistance min. 100MΩ, contact resistance max. 100mΩ	Bath temperature 40±2°C, humidity 90 to 95% R.H.
	Saltwater spray resistance (with FPC inserted)	24 hours, insulation resistance min. 100MΩ, contact resistance max. 100mΩ	Bath temperature 35±2°C, saltwater concentration 5±1%
	H ₂ S resistance (with FPC inserted)	48 hours, contact resistance max. 100mΩ	Bath temperature 40±2°C, gas concentration 3±1 ppm, humidity 75 to 80% R.H.
	Soldering heat resistance	Peak temperature: 260°C or less 300°C within 5 sec. 350°C within 3 sec.	Reflow soldering Soldering iron
Lifetime characteristics	Insertion and removal life	20 times	Repeated insertion and removal: min. 10 sec./time
	Unit weight	Y5B (50 contacts): 0.16 g	

2. Material and surface treatment

Part name	Material	Surface treatment
Molded portion	Housing: LCP resin (UL94V-0) Lever: LCP resin (UL94V-0)	—
Contact	Copper alloy	Contact portion; Base: Ni plating, Surface: Au plating Terminal portion; Base: Ni plating, Surface: Au plating
Holding contact portion	Copper alloy	Terminal portion; Base: Ni plating, Surface: Au plating
Soldering terminal portion	Copper alloy	Base: Ni plating, Surface: Au plating

DIMENSIONS (Unit: mm)

Y5B

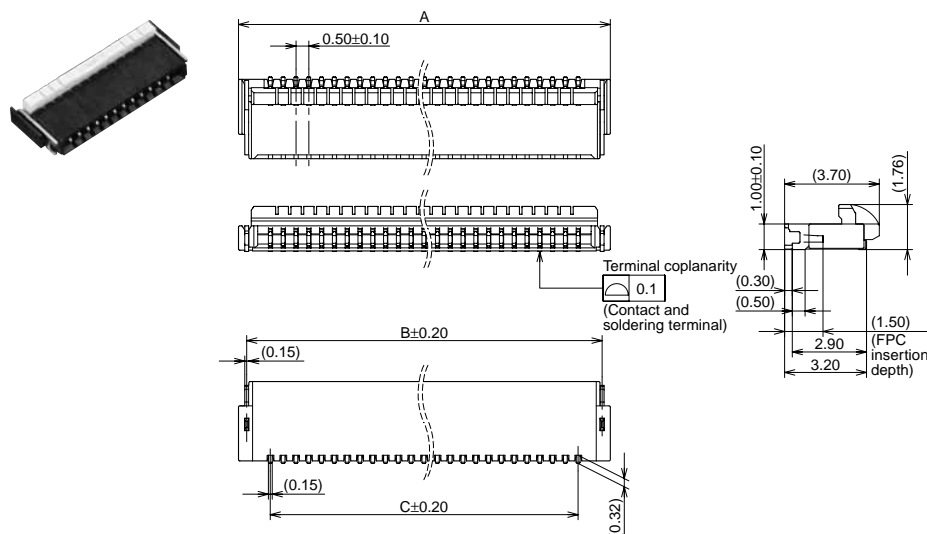

Number of contacts/ dimension	A	B	C
4	4.00	3.36	1.50
6	5.00	4.36	2.50
8	6.00	5.36	3.50
10	7.00	6.36	4.50
12	8.00	7.36	5.50
24	14.00	13.36	11.50
50	27.00	26.36	24.50

AYF53

Y5B RECOMMENDED FPC/FFC DIMENSIONS

The conductive parts should be based by Ni plating and then Au plating.

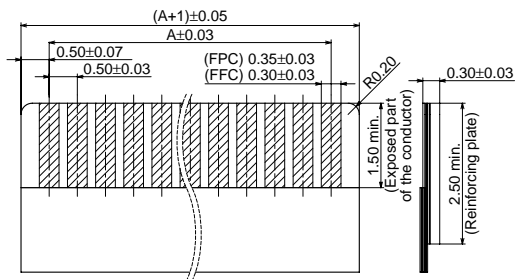

Number of contacts/ dimension	A
4	1.50
6	2.50
8	3.50
10	4.50
12	5.50
24	11.50
50	24.50

Y5BW

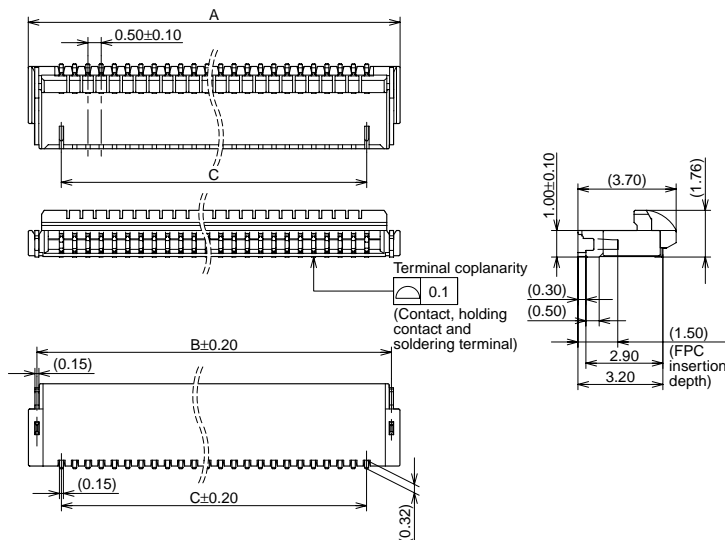

Number of contacts/ dimension	A	B	C
2	4.00	3.36	1.50
4	5.00	4.36	2.50
6	6.00	5.36	3.50
8	7.00	6.36	4.50
10	8.00	7.36	5.50
22	14.00	13.36	11.50
48	27.00	26.36	24.50

Y5BW RECOMMENDED FPC DIMENSIONS

The conductive parts should be based by Ni plating and then Au plating.

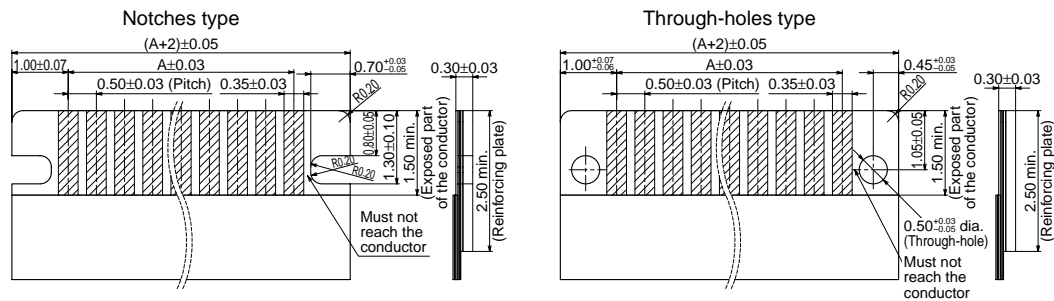

Number of contacts/ dimension	A
2	0.50
4	1.50
6	2.50
8	3.50
10	4.50
22	10.50
48	23.50

EMBOSSED TAPE DIMENSIONS (Unit: mm) (Common for respective contact type)

• Specifications for taping

(In accordance with JIS C 0806-1990. However, not applied to the mounting-hole pitch of some connectors.)

• Specifications for the plastic reel

(In accordance with EIAJ ET-7200B.)

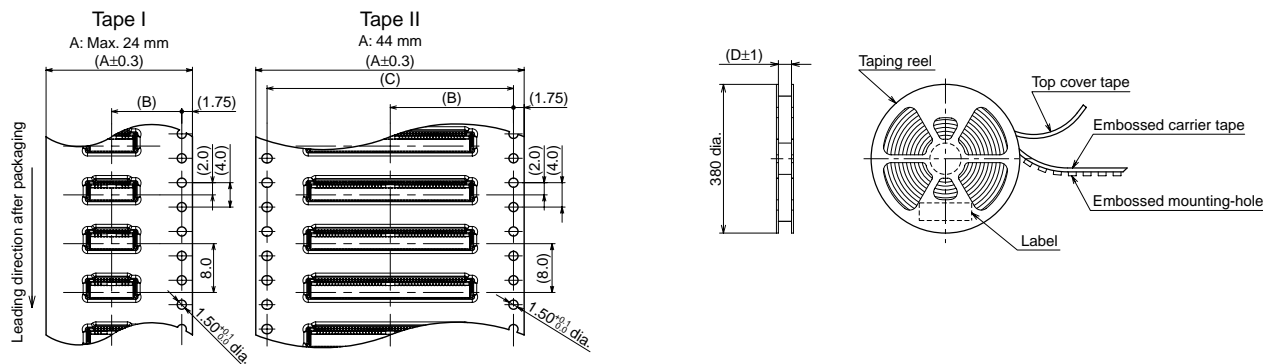

• **Y5B Dimension table** (Unit: mm)

Number of contacts	Type of taping	A	B	C	D	Quantity per reel
4, 6, 8, and 10 contacts	Tape I	16.0	7.5	–	17.4	5,000
12 and 24 contacts	Tape I	24.0	11.5	–	25.4	5,000
50 contacts	Tape II	44.0	20.2	40.4	45.4	5,000

• **Y5BW Dimension table** (Unit: mm)

Number of contacts	Type of taping	A	B	C	D	Quantity per reel
2, 4, 6, and 8 contacts	Tape I	16.0	7.5	–	17.4	5,000
10 and 22 contacts	Tape I	24.0	11.5	–	25.4	5,000
48 contacts	Tape II	44.0	20.2	40.4	45.4	5,000

• **Connector orientation with respect to embossed tape feeding direction**

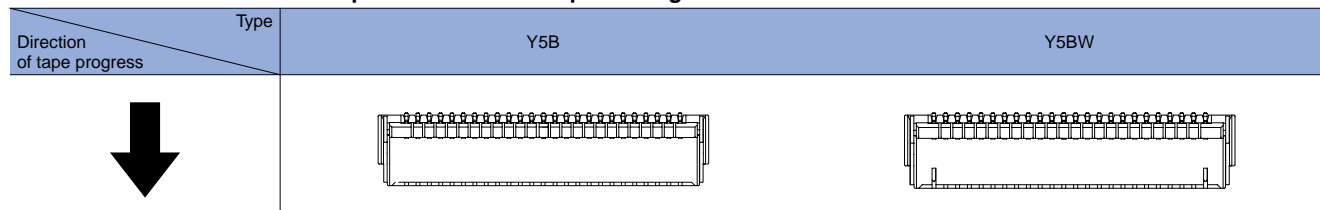

NOTES

1. Recommended PC board and metal mask patterns

Appropriate control of solder amount is required to minimize solder bridges and other defects for connectors with 0.3 mm or 0.5 mm pitch terminals, which require high-density mounting. Refer to the recommended PC board pattern.

• **Y5B**

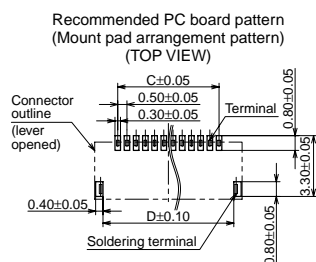

Number of contacts/dimension	C	D
4	1.50	3.10
6	2.50	4.10
8	3.50	5.10
10	4.50	6.10
12	5.50	7.10
24	11.50	13.10
50	24.50	26.10

• **Y5BW**

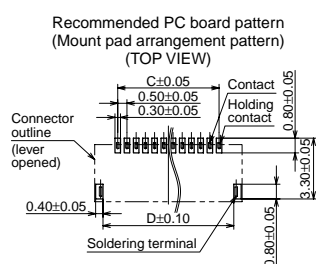

Number of contacts/dimension	C	D
2	1.50	3.10
4	2.50	4.10
6	3.50	5.10
8	4.50	6.10
10	5.50	7.10
22	11.50	13.10
48	24.50	26.10

2. Precautions for insertion/removal of FPC

Do not apply an excessive load to the lever in the opening direction beyond its open position; otherwise, the lever may be deformed or removed.
 Do not open/close the lever without an FPC inserted; otherwise, the terminals may be deformed, and the FPC insertion force may increase.
 Do not apply an excessive load to the lever in a direction perpendicular to the lever rotation axis or in the lever opening direction; otherwise, the terminals may be deformed, and the lever may be removed.

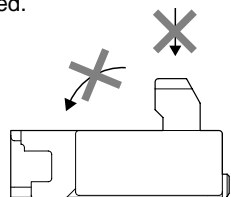

These connectors are of the back lock type, which has the FPC insertion section on the opposite side of the lever. Be careful not to make a mistake in the FPC insertion position or the lever opening/closing position. Otherwise, a contact failure or connector breakage may occur.

These connectors have top and bottom double contacts. Do not insert an FPC upside down. Inserting an FPC in a direction opposite to that you intended may cause an operation failure or malfunction.

Fully open the lever to insert an FPC.

Completely insert the FPC horizontally. An FPC inserted at an excessive angle to the board may cause the deformation of metal parts, FPC insertion failures, and FPC circuit breakages. Insert the FPC to the full depth of the connector without altering the angle.

To close the lever, turn down the lever by pressing the entire lever or both sides of the lever with the balls of fingers. Be careful. If pressure to the lever is applied unevenly, such as to an edge only, it may deform or break. Also, make sure that the lever is closed completely. Not doing so will cause a faulty connection.

Avoid applying an excessive load to the top of the lever during or after closing the lever. Otherwise, the terminals may be deformed.

When opening the lever to remove the FPC, ensure that the lever will not go over the initial position; otherwise, the lever may be removed.

Remove the FPC at parallel with the lever fully opened. If the lever is closed, or if the FPC is forcedly pulled, the product or FPC may break.

If a lever is accidentally detached during the handling of a connector, do not use the connector any longer.







After an FPC is inserted, carefully handle it so as not to apply excessive stress to the base of the FPC.

3. Cautions for using Y5BW

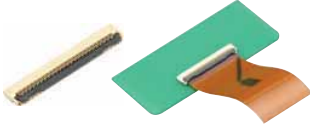
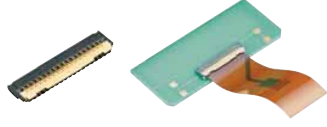
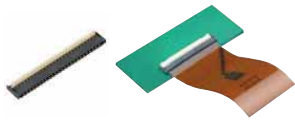
The holding contacts cannot be used as conductors.

The holding contacts are located on both ends of the contacts, and the shape of the soldered portions is the same as that of the other contacts. Therefore, be careful to avoid any confusion.

For other cautions, please refer to the last page.

0.3mm pitch type		
Y3FT	Y3F	Y3B
AYF31**15	AYF32**15	AYF33**35
		
<ul style="list-style-type: none"> ●Low-profile, space-saving design (Pitch: 0.3 mm) ●Compatible with FPC with tabs, reliability is increased through secure connectivity ●Wiring patterns can be located underneath the connector 	<ul style="list-style-type: none"> ●Low-profile, space-saving design (3.0mm pitch) ●Compatible with FPC without tabs, allowing smooth FPC insertion ●Wiring patterns can be located underneath the connector 	<ul style="list-style-type: none"> ●The world's slimmest* and low profile design (Pitch: 0.3 mm) ●Mechanical design freedom achieved by top and bottom double contacts ●Wiring patterns can be located underneath the connector
 <p>Front lock</p>	 <p>Front lock</p>	 <p>Back lock</p>
FPC	FPC	FPC
0.3mm	0.3mm	0.3mm
0.6mm	0.6mm	0.6mm
Bottom contact	Bottom contact	Top and bottom double contacts
0.9mm	0.9mm	0.9mm
		
3.2mm (Including lever) 3.0mm	3.2mm (Including lever) 3.0mm	3.15mm (Including lever) 2.95mm
51	51	51
41 45	41 45	45
31 33 35 39	31 33 35 39	31 33 35 39
23 25 27 29	23 25 27 29	21 23 25 27
15 17	15 17	7 9 11 13 15 17
0.2A/contact	0.2A/contact	0.2A/contact
50V AC/DC	50V AC/DC	50V AC/DC
-55°C to +85°C	-55°C to +85°C	-55°C to +85°C
30 times	30 times	20 times
SMD	SMD	SMD
Compliance	Compliance	Compliance

FPC CONNECTORS COMMON CAUTIONS FOR USE

COMMON CAUTIONS FOR USE

■ PC board design

Design the recommended foot pattern in order to secure the mechanical strength in the soldered areas of the terminal.

■ FPC and equipment design

Design the FPC based on the recommended dimensions to ensure the required connector performance. In addition, carefully check the equipment design and take required measures for the equipment to prevent the FPC from being removed subsequent to a fall, vibration, or other impact due to the FPC size, weight, or the reaction force of the routed FPC.

■ Connector mounting

In case the connector is picked up by chucking during mounting, an excessive moulder chucking force may deform the molded or metal part of the connector. Consult us in advance if chucking is to be applied.

■ Soldering

1) Manual soldering.

- Due to the low profile, if an excessive amount of solder is applied to this product during manual soldering, the solder may creep up to near the contact points, or interference by solder may cause imperfect contact.
 - Make sure that the soldering iron tip is heated within the temperature and time limits indicated in the specifications.
 - Flux from the solder wire may adhere to the contact surfaces during soldering operations. After soldering, carefully check the contact surfaces and clean off any flux before use.
 - Be aware that a load applied to the connector terminals while soldering may displace the contact.
 - Thoroughly clean the iron tip.
- 2) Reflow soldering
- Screen-printing is recommended for printing paste solder.

Y3FT/Y3F/Y3B/Y5F/Y5B/Y5BW

To determine the relationship between the screen opening area and the PC board foot pattern area, refer to the diagrams in the recommended patterns for PC boards and metal masks when setting.

Note that excess solder on the terminals prevents complete insertion of the FPC, and that excess solder on the metal clips prevents the lever from rotating.

Y5S

Note that excess solder inhibits the slider lock operation.

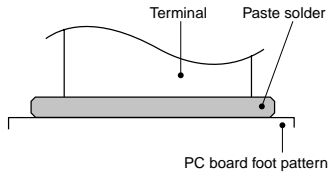

Y3FT/Y3F/Y3B/Y5S/Y5B/Y5BW

Screen thickness of 120 μ m is recommended for paste solder printing.

- Consult us when using a screen-printing thickness other than that recommended.
- Depending on the size of the connector being used, self alignment may not be possible. Accordingly, carefully position the terminal with the PC board pattern.
- The recommended reflow temperature profile is given in the figure below

Recommended reflow temperature profile

Y3FT/Y3F/Y3B/Y5B/Y5BW

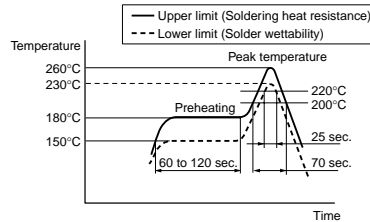

Y5S

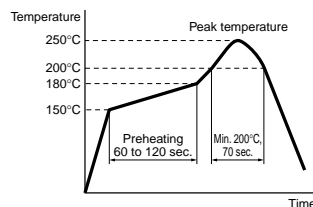

Y5F

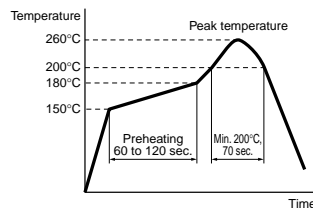

- The temperature is measured on the surface of the PC board near the connector terminal.

Some solder and flux types may cause serious solder creeping. Take the solder and flux characteristics into consideration when setting the reflow soldering conditions.

When performing reflow soldering on the back of the PC board after reflow soldering the connector, secure the connector using, for example, an adhesive. (Double reflow soldering on the same side is possible)

3) Reworking on a soldered portion

- Finish reworking in one operation.
- For reworking of the solder bridge, use a soldering iron with a flat tip. Do not add flux, otherwise, the flux may creep to the contact parts.

Use a soldering iron whose tip temperature is within the temperature range specified in the specifications.

Do not drop the product or handle carelessly. Otherwise, the terminals may become deformed due to excessive force or the solderability during reflow soldering may degrade.

Don't open/close the lever or insert/remove an FPC until the connector is soldered. Forcibly applied external pressure on the terminals can weaken the adherence of the terminals to the molded part or cause the terminals to lose their evenness. In addition, do not insert an FPC into the connector before soldering the connector.

When cutting or bending the PC board after mounting the connector, be careful that the soldered sections are subjected to excessive forces.

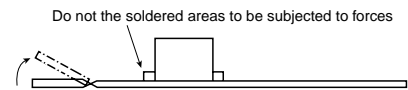

■ Other Notes

When coating the PC board after soldering the connector to prevent the deterioration of insulation, perform the coating in such a way so that the coating does not get on the connector.

The connectors are not meant to be used for switching.

For other details, please verify with the product specification sheets.