

KPT/KPSE
CONNECTORS



KP-6/898

ITT Cannon

Contents

| | |
|--|----|
| Introduction..... | 2 |
| Standard Data..... | 3 |
| Series KPT..... | 4 |
| Series KPSE..... | 6 |
| Contact arrangements..... | 9 |
| Wall mounting receptacles..... | 13 |
| Cable connecting plugs..... | 14 |
| Box mounting receptacles..... | 15 |
| Thru-bulkhead receptacles..... | 15 |
| Straight plugs..... | 16 |
| Jam nut receptacles..... | 17 |
| Right angle plugs..... | 18 |
| Special versions | |
| Connectors with grounding continuity..... | 19 |
| Receptacles with straight solder pins..... | 22 |
| Panel cutouts..... | 24 |
| Dummy receptacle..... | 25 |
| Protective caps..... | 26 |
| Tools | 27 |
| Assembly instructions | 28 |
| Cross reference lists | 29 |
| Product safety information..... | 31 |

Introduction

The miniature circular connectors series KPT and KPSE from ITT Cannon are manufactured acc. to MIL-C-26482 with three point bayonet coupling and five-keyway polarization. They offer general purpose solder connectors and high performance crimp connectors. The broad product range provides the most complete family of connectors conform to MIL-C-26482, NFC 93422 HE 301 model, VG 95328 and LN 29500 specifications.

The versatility of these connectors has been proven by their usage in general as well as in high performance environmental applications.

In addition to the basic series presented in this catalogue, connectors for special applications are available. They include corrosion resistant types, filter connectors for electromagnetic compatibility and non-outgassing, radiation resistant versions.

All connectors conform to the above mentioned specifications are fully interchangeable and accept a wide range of interchangeable accessories. Thereby design modifications can be achieved more easily and at lower cost with connectors of the KPT/KPSE series.

Technical Data

| | KPT | KPSE |
|------------------------------|---|---------------------------|
| Material and Finishes | | |
| Shell | Aluminum alloy, conductive olive drab chromate over cadmium finish per QQ-P-416 | |
| Insulator | Polychloroprene | Polychloroprene |
| Grommet and Seal | Polychloroprene | Polychloroprene |
| Contacts | Copper alloy, gold plated | Copper alloy, gold plated |

Mechanical Data

| | | |
|-----------------------|--|---|
| Shell styles | 00 – Wall mounting receptacle 01 – Cable connecting plug 02 – Box mounting receptacle | 07 – Jam nut receptacle 08 – Plug with 90° termination assemblies B – Thru-bulkhead receptacle (KPT only) |
| 06 – Straight plug | | |
| Shell sizes | 8 thru 24 | |
| Polarisation/Coupling | five keyways/three point bayonet | |
| Service classes | A – General duty B – General duty with strain relief E – Grommet seal F – Grommet seal with strain relief | G – Gland seal for jacketed cable J – Gland nut with strain relief for jacketed cable P – for potting see also pages 5 and 8 |
| E – Grommet seal | | |
| Water tightness | Acc. to VG 95319 Part 2, Test No. 5.9.2 For styles A to E and J to W, Z1, Z2 and Z3 and gaskets style A and B only Test pressure 0,2 bar overpressure Test temperature 25 ± 3°C | Test duration 48 h The connector shall be free of moisture |
| Operating temperature | – 55 / 125°C | |
| Durability | min. 500 mating cycles | |
| Vibration | 200 m/s ² at 10 to 2000 Hz | |

Electrical Data

| | | | | | |
|---|----------------------|-----------------|-----------------|-------------------|-----------------------------|
| Number of contacts | 2 thru 61 | 3 thru 61 | | | |
| Wire size AWG | 16 thru 24 | 12 thru 24 | | | |
| Contact termination | Solder | Crimp | | | |
| Contact rating | Size AWG | Rated current A | Test current A | Millivolt drop mV | |
| | 20 | 7,5 | 7,5 | less than 55 | |
| | 16 | 22,0 | 13,0 | less than 50 | |
| Insulation resistance | ⊕ 5000 MW | | | | |
| Service rating | Test voltage | Service class | Vrms | VDC | With scoop proof connectors |
| Exception | Sea level | 1 | 1500 | 2100 | operating voltages |
| Service rating between the central contact and the housing of the coaxial contact | | 2 | 2300 | 3200 | acc. to MIL-C-26482 and |
| | 21336 m (70 000 ft.) | 1 | 375 | 535 | VG 96912 are permitted |
| | | 2 | 550 | 770 | |
| | Operating voltage | | | | |
| | Service class | | VG 95328 | MIL-C-26482 | |
| | 1 | | 140 VDC/100 VAC | 850 VDC/600 VAC | |
| | 2 | | 165 VDC/115 VAC | 1400 VDC/1000 VAC | |

Operating voltage and connector usage

Connectors are equipment which must not be separated or mated when used as per determination. As acc. to specification the connectors are suitable for an operating voltage of 50 V (see Product Safety Information). However, this is only valid when the connectors are free accessible during operation and consequently might be touchable. When the connectors will be operated with line voltage, ITT Cannon offers a solution, too. Please consult factory.

KPT General purpose solder contact connectors

- General purpose
- Solder termination
- Closed entry socket contacts

Series KPT from ITT Cannon offers general purpose connectors, qualified for use in military applications but also widely used in industrial applications calling for a circular connector with fixed contacts for solder termination.

The KPT series is MIL-C-26482 approved and is intermateable with all connectors acc. to the above mentioned specifications.

KPT General purpose solder contact connectors

How to order*

| | KPT | 02 | E | 22 | - | 36 | P | W | * |
|---|-----|----|---|----|---|----|---|---|---|
| Series Prefix _____ KPT – ITT Cannon Prefix | | | | | | | | | |
| Shell style _____ ITT Cannon designation 00 – wall mounting receptacle 01 – cable connecting plug 02 – box mounting receptacle (class E only), not with contact arrangement 14A4 06 – straight plug 07 – jam nut receptacle (hermetic version also available) 08 – 90° angle plug B – thru-bulkhead receptacle (class E only) | | | | | | | | | |
| Class _____ A – general duty with intermediate endbell B – general duty with strain relief (may be used for potting) E – with a grommet seal, not for 02 and 3112 (MS Spec) F – grommet seal with strain relief (MS Spec) G – gland seal for jacketed cable J – watertight gland seal with strain relief for jacketed cable P – for potting (MS Spec) | | | | | | | | | |
| Shell sizes _____ 8, 10, 12, 14, 16, 18, 20, 22 und 24 | | | | | | | | | |
| Contact arrangement _____ see page 9 – 11 | | | | | | | | | |
| Contact type _____ P – pin S – socket | | | | | | | | | |
| Alternate insert position _____ W, X, Y and Z (omit for normal) see page 12 | | | | | | | | | |
| Modification code _____ DN – Shrink boot adapter for shell styles 00, 01, 06 and 07 DZ – Endbell for shielding braids and shrink boots. Class E will always be used for these modifications. | | | | | | | | | |

Consult factory for other modifications. Omit first digit (0) of shell style indication when using a modification code.

***Note:**

The above mentioned order reference explanation refers only to the ITT Cannon ordering system. For other order references according to a specification, please consult the cross reference list on pages 29 – 30.

KPSE High performance crimp contact connectors

- High performance
- Crimp termination
- Closed entry socket contacts

Series KPSE environmental, miniature circular, quick disconnect connectors are designed for the exacting requirements of today's electronic industry.

They are intermateable, intermountable and interchangeable with all connectors manufactured acc. to MIL-C-26482, LN 29500, VG 95328, NFC 93422 HE 301 and NFL 54125.

Connectors of ITT Cannon series KPSE have obtained the VDE Expertise No. 63761.

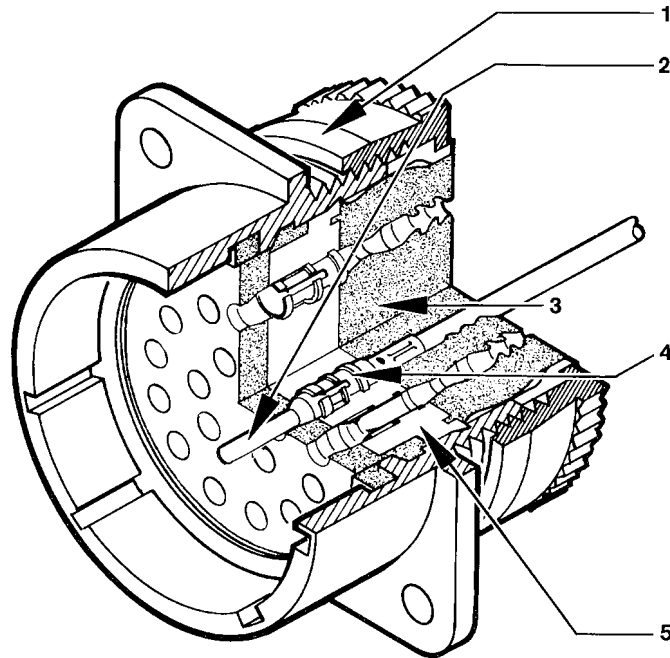

1 Standard MIL-C-26482 or NFL 54 125 Hardware
mates with any connector designed to MIL-C-26 482, LN 29500 or NF L 54 125 or NF C 93 422, HE 301 model

2 Crimp, snap-in contacts
are designed to MIL-C-23216 and can be crimped with the standard M22520/1 crimp tool.

CLOSED-ENTRY SOCKET CONTACTS
eliminate damage from abuse by test probes and help to correct any misaligned pins during engagement.

CONTACT INSERTION
is accomplished from the rear of the connector. When the contact is fully inserted, the clip tines snap securely behind the contact shoulder.

CONTACT EXTRACTION
is accomplished with a front-inserted extraction tool. Pressing the tool plunger pushes the contact out through the rear of the connector.

3 Monobloc insulator
does not leave any access to moisture and avoids interfacial empty space.

4 Contact retaining clip
is completely encased in a tough plastic wafer to protect the clip from damage.

Complete moisture sealing
is achieved by combining four seals: shell, peripheral, interfacial and wire seals.

SHELL SEAL
is effected when the plug shell pushes against the sealing ring in the receptacle when the connectors are mated.

PERIPHERAL SEAL
around the edge of the pin insulator is designed so that mating the connector puts tension on the seal and greatly reduces compression set.

INTERFACIAL SEAL
is achieved by the insulator faces meeting when the plug and receptacle are mated.

WIRE SEAL
is accomplished by a multiple ripple design, exceeding the wire sealing requirements of MIL-C-26482.

5 Positive insert-to-shell mechanical retention
with hard plastic wafer firmly locked into a groove in the shell, in addition to a strong adhesive bond between the insert and shell.

KPSE High performance crimp contact connectors

How to order acc. to VG 95328

VG 95328 A 18 - 1 S N

Specification _____

Shell style _____

- A – wall mounting receptacle with straight endbell
- B – wall mounting receptacle with cable clamp
- C – box mounting receptacle
- D – jam nut receptacle
- E – jam nut receptacle with cable clamp
- J – straight plug with adapter DN
- K – straight plug with cable clamp
- M – straight plug, version DZ
- N – straight plug
- R – wall mounting receptacle, version DZ
- S – jam nut receptacle with adapter DN
- T – jam nut receptacle, version DZ

Shell size _____

8, 10, 12, 14, 16, 18, 20, 22 und 24

Contact arrangement _____

see pages 9 – 11

Contact type _____

- P – pin
- S – socket

Alternate insert position _____

see page 12

KPSE High performance crimp contact connectors

How to order

KPSE 00 E 18 - 32 P X *

Series prefix _____

KPSE – ITT Cannon prefix

MS – MIL-C-26482 prefix

Shell style _____

ITT Cannon designation

00 – wall mounting receptacle

01 – cable connecting plug

02 – box mounting receptacle

06 – straight plug

07 – jam nut receptacle

08 – 90° angle plug

Class _____

A – general duty (not MS approved)

B – general duty with strain relief (not MS approved)

E – grommet seal (MS specification)

F – grommet seal with strain relief (MS specification)

G – gland seal for jacketed cable

J – gland seal with strain relief for jacketed cable

(not MS approved)

P – for potting (MS specification)

Shell style _____

8, 10, 12, 14, 16, 18, 20, 22 und 24

Contact arrangement _____

see pages 9 – 11

Contact type _____

P – pin

S – socket

Alternate insert position _____

W, X, Y and Z (omit for normal), see page 12

Modification code _____

DN – Shrink boot adapter for shell styles 00, 01, 06 and 07

DZ – Endbell for shielding braids and shrink boots.

Class E will always be used for these modifications.

Consult factory for other modifications. Omit first digit (0) of shell style indication when using a modification code.

***Note:**

The above mentioned order reference explanation refers only to the ITT Cannon ordering system. For other order references according to a specification, please consult the cross reference list on pages 29 – 30.

Contact Arrangements

| | No. of contacts | Contact arrangement Contact size AWG | Service rating | Insulator position | | | | Insulator weight (g) including contacts | |
|--|-----------------|--|----------------|--------------------|-----|-----|-----|---|--------|
| | | | | W | X | Y | Z | pin | socket |
| | 2 | 8-2 ▲△ 20 | 1 | 58 | 122 | - | - | | |
| | 3 | 8-3 ▲△ 20 | 1 | 60 | 210 | - | - | | |
| | 3 | 8-3A ▲●◇▼ 20 | 1 | 60 | - | - | - | | |
| | 3 | 8-33 ▲◇△ 16S | 1 | 90 | - | - | - | | |
| | 4 | 8-4 ▲△ 16S | 1 | 45 | - | - | - | | |
| | 6 | 10-6 ●◇△▼ 20 | 1 | 90 | - | - | - | | |
| | 3 | 12-3 ▲●◇△▼ 16 | 2 | - | - | 180 | - | | |
| | 10 | 12-10 ▲●◇△▼ 20 | 1 | 60 | 155 | 270 | 295 | | |
| | 5 | 14-5 ▲△ 16 | 2 | 40 | 92 | 184 | 273 | | |
| | 12 | 14-12 ▲△ 20 (8) 16 (4) | 1 | 43 | 90 | - | - | | |

Legende

▲ KPT ◇ KPSE ▼ LN29500 △ authorized per MIL-C-26482 ● authorized per VG95328



Contact Arrangements

| | No. of contacts | Contact arrangement Contact size AWG | Service rating | Insulator position | | | | Insulator weight (g) including contacts | |
|--|-----------------|--|----------------|--------------------|-----|-----|-----|---|--------|
| | | | | W | X | Y | Z | pin | socket |
| | 15 | 14-15 ▲●◇△▼ 20 | 1 | 17 | 110 | 155 | 124 | | |
| | 19 | 14-19 ▲●◇△▼ 20 | 1 | 30 | 165 | 315 | - | | |
| | 5 | 14-22 ● 12 (1) 20 (4) | 1 | - | - | - | - | | |
| | 4 | 14A4 ▲ Coax RG188U | 1 | - | - | - | - | | |
| | 8 | 16-8 ▲●◇△ 16 | 2 | 54 | 152 | 180 | 331 | | |
| | 23 | 16-23 ▲●◇ 20 (22) 16 (1) | 1 | 158 | 270 | - | - | | |
| | 26 | 16-26 ▲●◇△ 20 | 1 | 60 | - | 275 | 338 | | |
| | 11 | 18-11 ▲●◇△▼ 16 | 2 | 62 | 119 | 241 | 340 | | |
| | 32 | 18-32 ▲●◇△▼ 20 | 1 | 85 | 138 | 222 | 265 | | |

Legende

▲ KPT ◇ KPSE ▼ LN29500 △ authorized per MIL-C-26482 ● authorized per VG95328

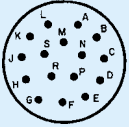
Contact Arrangements

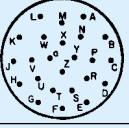
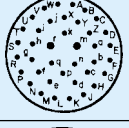
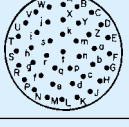
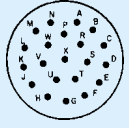
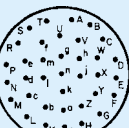
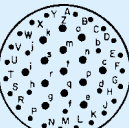
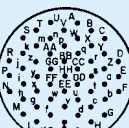
| | No. of contacts | Contact arrangement Contact size AWG | Service rating | Insulator position | | | | Insulator weight (g) including contacts | |
|---|-----------------|--|----------------|--------------------|-----|-----|-----|---|--------|
| | | | | W | X | Y | Z | pin | socket |
|  | 16 | 20-16 ▲●◇△▼ 16 | 2 | 238 | 318 | 333 | 347 | | |
|  | 5 | 20A6 ◇ 12 | 2 | 90 | 180 | 270 | - | | |
|  | 24 | 20-24 ▲ 20 | 1 | 70 | 145 | 215 | 290 | | |
|  | 39 | 20-39 ▲●◇△ 20 (37) 16 (2) | 1 | 63 | 114 | 252 | 333 | | |
|  | 41 | 20-41 ▲●◇△▼ 20 | 1 | 45 | 126 | 225 | - | | |
|  | 21 | 22-21 ▲●◇△ 16 | 2 | 16 | 135 | 175 | 349 | | |
|  | 36 | 22-36 ▲● 20 | 1 | 72 | 144 | 216 | 288 | | |
|  | 41 | 22-41 ▲●◇△▼ 20 (27) 16 (14) | 1 2 | 39 | 135 | 264 | - | | |
|  | 55 | 22-55 ▲●◇△▼ 20 | 1 | 30 | 142 | 226 | 314 | | |

Legende

▲ KPT ◇ KPSE ▼ LN29500 △ authorized per MIL-C-26482 ● authorized per VG95328

Contact arrangements

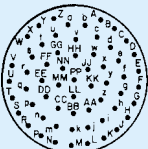
| | No. of contacts | Contact arrangement Contact size AWG | Service rating | Insulator position | | | | Insulator weight (g) including contacts | |
|---|-----------------|--|----------------|--------------------|-----|-----|-----|---|--------|
| | | | | W | X | Y | Z | pin | socket |
|  | 61 | 24-61 ▲●◇△ 20 | 1 | 90 | 180 | 270 | 324 | | |

Alternate Insert Position

The diagram indicates alternate insert positions. The six positions N, V, W, Y, Z differ in degree of rotation for various sizes and arrangements. For the exact degree of rotation, for the list of contact arrangements and for alternate positions available, refer to the table at the right.

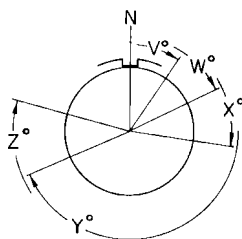

| Shell size | Nbr. of contacts | Contact arr. | Degree of rotation | | | | |
|------------|------------------|--------------|--------------------|-----|-----|-----|-----|
| | | | V | W | X | Y | Z |
| 8 | 2 | 8-2 | - | 58 | 122 | - | - |
| | 3 | 8-3 | - | 60 | 210 | - | - |
| | 3 | 8-3A | - | 60 | - | - | -- |
| | 3 | 8-33 | - | 90 | - | - | - |
| 4 | 8-4 | - | 45 | - | - | - | - |
| 10 | 6 | 10-6 | - | 90 | - | - | -- |
| 12 | 3 | 12-3 | - | - | - | 180 | - |
| | 10 | 12-10 | - | 60 | 155 | 270 | 295 |
| 14 | 4 | 14A4 | - | - | - | - | - |
| | 5 | 14-22 | - | - | - | - | - |
| | 5 | 14-22 | - | 40 | 92 | 184 | 273 |
| | 12 | 14-5 | - | 43 | 90 | - | - |
| | 15 | 14-15 | - | 17 | 110 | 155 | 234 |
| | 19 | 14-19 | - | 30 | 165 | 315 | - |
| 16 | 8 | 16-8 | - | 54 | 52 | 180 | 331 |
| | 23 | 16-23 | - | 158 | 270 | - | - |
| | 26 | 16-26 | - | 60 | - | 275 | 338 |
| | 18 | 18-11 | - | 62 | 119 | 241 | 340 |
| 18 | 32 | 18-32 | - | 85 | 138 | 222 | 265 |
| | 5 | 20A6* | - | 90 | 180 | 270 | - |
| | 16 | 20-16 | - | 238 | 318 | 333 | 347 |
| | 24 | 20-24 | - | 70 | 145 | 215 | 290 |
| | 39 | 20-39 | - | 63 | 114 | 252 | 333 |
| 20 | 41 | 20-41 | - | 45 | 126 | 225 | - |
| | 22 | 22-21 | - | 16 | 135 | 175 | 349 |
| | 36 | 22-36 | - | 72 | 144 | 216 | 288 |
| | 41 | 22-41 | - | 39 | 135 | 264 | - |
| 22 | 55 | 22-55 | - | 30 | 142 | 226 | 314 |
| | 24 | 24-61 | - | 90 | 180 | 270 | 324 |

* This contact arrangement features five contacts size 12. Four are standard contacts and one is a first-to-mate contact.

Wall mounting receptacles

KPT00/MS3110 KPSE00/MS3120

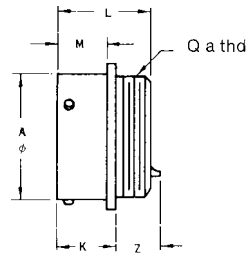
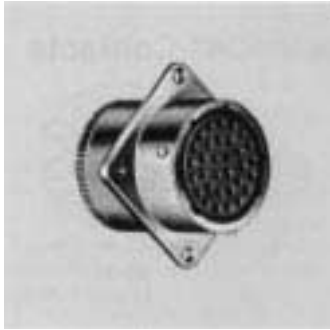

Solder
KPT00/MS3110

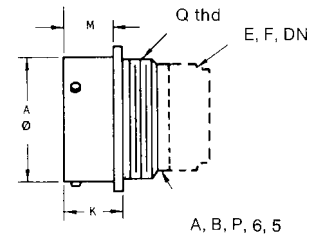
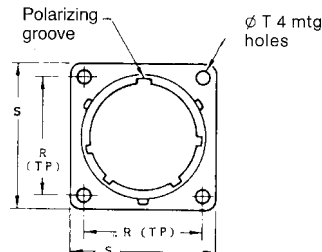

Crimp
KPSE00/MS3120

Without termination assembly

| | KPT/KPSE | | | | | | | | | KPT |
|-------------|-------------|------|----------------|-------|-------|-------|------|-------|------|-----|
| Shell size* | Ø A | L | Q | K | M | R | S | T | Z | |
| | +0,03 -0,13 | max. | Thread Type 2A | ±0,25 | ±0,15 | ±0,15 | max. | ±0,15 | max. | |
| ◆8 | 12,00 | 21,6 | 7/16-28UNEF | 13,5 | 11,6 | 15,1 | 21,0 | 3,05 | 12,3 | |
| 10 | 15,00 | 21,6 | 9/16-24UNEF | 13,5 | 11,6 | 18,3 | 24,2 | 3,05 | 12,3 | |
| 12 | 19,05 | 21,6 | 11/16-24UNEF | 13,5 | 11,6 | 20,6 | 26,6 | 3,05 | 12,3 | |
| 14 | 22,23 | 21,6 | 13/16-20UNEF | 13,5 | 11,6 | 23,0 | 29,0 | 3,05 | 12,3 | |
| 16 | 25,40 | 21,6 | 15/16-20UNEF | 13,5 | 11,6 | 24,6 | 31,3 | 3,05 | 12,3 | |
| 18 | 28,58 | 21,6 | 1- 1/16-18UNEF | 13,5 | 11,6 | 27,0 | 33,7 | 3,05 | 12,3 | |
| 20 | 31,75 | 26,8 | 1- 3/16-18UNEF | 16,5 | 14,25 | 29,4 | 36,9 | 3,05 | 10,8 | |
| 22 | 34,93 | 26,8 | 1- 5/16-18UNEF | 16,5 | 14,25 | 31,8 | 40,1 | 3,05 | 10,8 | |
| 24 | 38,10 | 26,8 | 1- 7/16-18UNEF | 17,3 | 15,1 | 34,9 | 43,3 | 3,75 | 10,0 | |

With termination assemblies

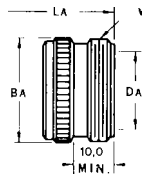

Type A

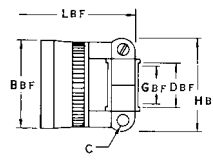

Type B or F

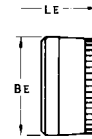

Type E

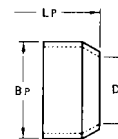

Type P

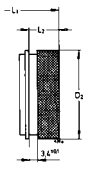

Mod. DN or F 185

| Shell size* | Typ A | | | | Typ B and F | | | | | | |
|-------------|---------------------|---------------------|---------------------|---------------|----------------------|------|----------------------|----------------------|----------------------|----------------------|--|
| | B _A max. | D _A min. | L _A max. | V | B _{BF} max. | C | D _{BF} min. | G _{BF} min. | H _{BF} max. | L _{BF} max. | |
| ◆8 | 15,0 | 8,5 | 38,0 | 1/2-28UNEF | 14,0 | 6-32 | 6,0 | 2,9 | 19,3 | 45,1 | |
| 10 | 18,2 | 11,8 | 38,0 | 5/8-24UNEF | 17,2 | 6-32 | 7,5 | 4,5 | 20,8 | 45,1 | |
| 12 | 21,2 | 15,0 | 38,0 | 3/4-20UNEF | 20,4 | 6-32 | 10,7 | 7,7 | 24,4 | 45,1 | |
| 14 | 24,6 | 17,9 | 38,0 | 7/8-20UNEF | 23,6 | 6-32 | 13,9 | 9,3 | 27,2 | 45,1 | |
| 16 | 27,7 | 21,1 | 38,0 | 1 -20UNEF | 26,7 | 6-32 | 15,5 | 12,4 | 28,7 | 48,2 | |
| 18 | 30,9 | 24,1 | 38,0 | 1-3/16-18UNEF | 29,5 | 8-32 | 19,6 | 15,6 | 35,3 | 48,2 | |
| 20 | 33,9 | 26,5 | 43,1 | 1-3/16-18UNEF | 32,7 | 8-32 | 19,6 | 15,6 | 35,3 | 50,0 | |
| 22 | 37,1 | 30,4 | 43,1 | 1-7/16-18UNEF | 35,9 | 8-32 | 23,6 | 18,8 | 39,9 | 50,0 | |
| 24 | 40,3 | 32,8 | 43,1 | 1-7/16-18UNEF | 39,0 | 8-32 | 25,2 | 20,1 | 43,2 | 50,0 | |

| Shell size* | Type E | | Type P | | | Mod. DN or F 185 | | |
|-------------|---------------------|---------------------|---------------------|---------------------|---------------------|------------------|------|------|
| | B _E max. | L _E max. | B _P max. | D _P min. | L _P max. | D2 | L1 | L2 |
| ◆8 | 14,2 | 32,5 | 15,3 | 8,3 | 36,9 | 15,6 | 35,0 | 12,2 |
| 10 | 17,2 | 32,5 | 17,6 | 11,3 | 36,9 | 18,4 | 35,0 | 12,2 |
| 12 | 20,4 | 32,5 | 21,6 | 14,2 | 36,9 | 23,7 | 35,0 | 12,2 |
| 14 | 23,4 | 32,5 | 24,3 | 17,3 | 36,9 | 24,5 | 35,0 | 12,2 |
| 16 | 26,6 | 32,5 | 27,6 | 20,5 | 36,9 | 29,8 | 37,0 | 14,5 |
| 18 | 29,6 | 32,5 | 31,0 | 23,1 | 36,9 | 32,0 | 37,0 | 14,5 |
| 20 | 32,8 | 34,5 | 34,3 | 26,3 | 42,2 | 36,1 | 42,0 | 15,8 |
| 22 | 36,0 | 34,5 | 37,1 | 29,4 | 42,2 | 38,5 | 42,0 | 15,8 |
| 24 | 39,2 | 34,5 | 40,5 | 32,6 | 43,9 | 41,6 | 42,0 | 14,9 |

* See page 5, 7 and 8 for ordering number information

◆ in series KPSE only contact arrangements 8-3A and 8-33 available

Cable connecting plugs

KPT01/MS3111 KPSE01/MS3121

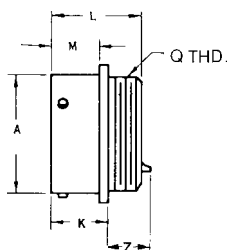
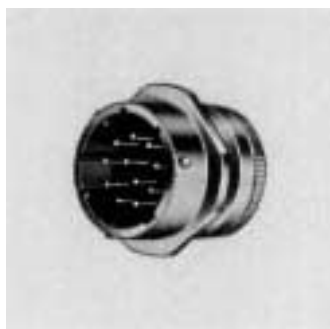

Solder
KPT01/MS3111

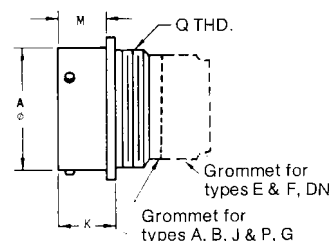
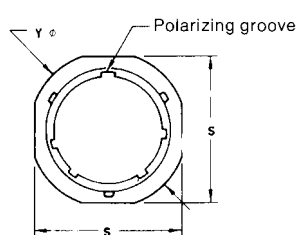

Crimp
KPSE01/MS3121

Without termination assembly

| | KPT/KPSE | | | | | | | KPT |
|-------------|-------------|-------|------|-------|----------------|------|------|------|
| Shell size* | Ø A | K | L | M | Q | S | Ø Y | Z |
| ◆8 | +0,03 -0,13 | ±0,25 | max. | ±0,15 | Thread Type 2A | max. | max. | max. |
| 10 | 12,00 | 13,5 | 21,5 | 11,6 | 7/16-28UNEF | 18,5 | 21,0 | 12,3 |
| 12 | 15,00 | 13,5 | 21,5 | 11,6 | 9/16-24UNEF | 23,0 | 24,2 | 12,3 |
| 14 | 19,05 | 13,5 | 21,5 | 11,6 | 11/16-24UNEF | 29,0 | 26,6 | 12,3 |
| 16 | 22,23 | 13,5 | 21,5 | 11,6 | 13/16-20UNEF | 29,5 | 29,0 | 12,3 |
| 18 | 25,40 | 13,5 | 21,5 | 11,6 | 15/16-20UNEF | 32,0 | 31,3 | 12,3 |
| 20 | 28,58 | 13,5 | 21,5 | 11,6 | 1- 1/16-18UNEF | 35,0 | 33,7 | 12,3 |
| 22 | 31,75 | 16,5 | 26,8 | 14,25 | 1- 3/16-18UNEF | 38,5 | 36,9 | 10,8 |
| 24 | 34,93 | 16,5 | 26,8 | 14,25 | 1- 5/16-18UNEF | 42,0 | 40,1 | 10,8 |
| 24 | 38,10 | 17,5 | 26,8 | 15,1 | 1- 7/16-18UNEF | 46,0 | 43,3 | 10,0 |

With termination assemblies

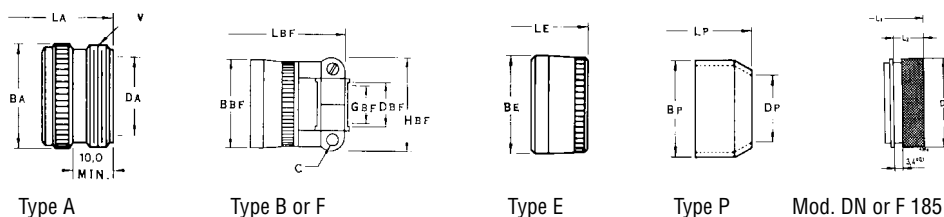

| Shell size* | Typ A | | | | Type B and F | | | | | |
|-------------|---------------------|---------------------|---------------------|---------------|----------------------|------|----------------------|----------------------|----------------------|----------------------|
| | B _A max. | D _A min. | L _A max. | V | B _{BF} max. | C | D _{BF} min. | G _{BF} min. | H _{BF} max. | L _{BF} max. |
| ◆8 | 15,0 | 8,5 | 38,0 | 1/2-28UNEF | 14,0 | 6-32 | 6,0 | 2,9 | 19,3 | 46,0 |
| 10 | 18,2 | 11,8 | 38,0 | 5/8-24UNEF | 17,2 | 6-32 | 7,5 | 4,5 | 20,8 | 46,0 |
| 12 | 21,2 | 15,0 | 38,0 | 3/4-20UNEF | 20,4 | 6-32 | 10,7 | 7,7 | 24,4 | 46,0 |
| 14 | 24,6 | 17,9 | 38,0 | 7/8-20UNEF | 23,6 | 6-32 | 13,9 | 9,3 | 27,2 | 46,0 |
| 16 | 27,7 | 21,1 | 38,0 | 1-20UNEF | 26,7 | 6-32 | 15,5 | 12,4 | 28,7 | 49,0 |
| 18 | 30,9 | 24,1 | 38,0 | 1-3/16-18UNEF | 29,5 | 8-32 | 19,6 | 15,6 | 35,3 | 49,0 |
| 20 | 33,9 | 26,5 | 43,1 | 1-3/16-18UNEF | 32,7 | 8-32 | 19,6 | 15,6 | 35,3 | 51,1 |
| 22 | 37,1 | 30,4 | 43,1 | 1-7/16-18UNEF | 35,9 | 8-32 | 23,6 | 18,8 | 39,9 | 51,1 |
| 24 | 40,3 | 32,8 | 43,1 | 1-7/16-18UNEF | 39,0 | 8-32 | 25,2 | 20,1 | 43,2 | 51,1 |

| Shell size* | Type E | | Type P | | | Mod. DN or F 185 | | |
|-------------|---------------------|---------------------|---------------------|---------------------|---------------------|------------------|------|------|
| | B _E max. | L _E max. | B _P max. | D _P min. | L _P max. | D2 | L1 | L2 |
| ◆8 | 14,2 | 32,5 | 15,3 | 8,3 | 36,9 | 15,6 | 35,0 | 12,2 |
| 10 | 17,2 | 32,5 | 17,6 | 11,3 | 36,9 | 18,4 | 35,0 | 12,2 |
| 12 | 20,4 | 32,5 | 21,6 | 14,2 | 36,9 | 23,7 | 35,0 | 12,2 |
| 14 | 23,4 | 32,5 | 24,3 | 17,3 | 36,9 | 24,5 | 35,0 | 12,2 |
| 16 | 26,6 | 32,5 | 27,6 | 20,5 | 36,9 | 29,8 | 37,0 | 14,5 |
| 18 | 29,6 | 32,5 | 31,0 | 23,1 | 36,9 | 32,0 | 37,0 | 14,5 |
| 20 | 32,8 | 34,5 | 34,3 | 26,3 | 42,2 | 36,1 | 42,0 | 15,8 |
| 22 | 36,0 | 34,5 | 37,1 | 29,4 | 42,2 | 38,5 | 42,0 | 15,8 |
| 24 | 39,2 | 34,5 | 40,5 | 32,6 | 43,9 | 41,6 | 42,0 | 14,9 |

* See page 5, 7 and 8 for ordering number information

◆ in series KPSE only contact arrangements 8-3A and 8-33 available

Box mounting receptacles

KPT02/MS3112 KPSE02/MS3122

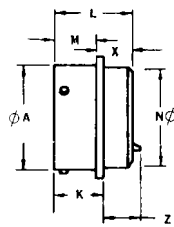
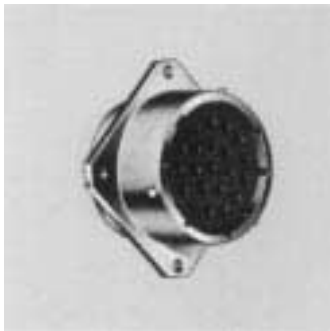

Solder
KPT02/MS3112

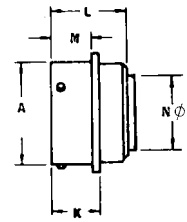
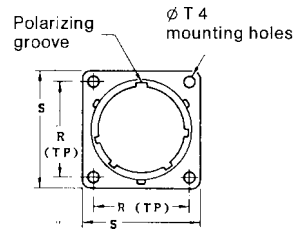

Crimp
KPSE02/MS3122

Without termination assemblies

| | KPT/KPSE | | | | | | | | | KPT |
|-------------|-------------|------|------|-------|-------|-------|------|-------|------|-----|
| Shell size* | Ø A | L | N | K | M | R | S | T | Z | |
| | +0,03 -0,13 | max. | max. | ±0,25 | ±0,15 | ±0,15 | max. | ±0,15 | max. | |
| ◆8 | 12,00 | 21,1 | 11,1 | 13,5 | 11,6 | 15,1 | 21,0 | 3,05 | 12,3 | |
| 10 | 15,00 | 21,1 | 14,3 | 13,5 | 11,6 | 18,3 | 24,2 | 3,05 | 12,3 | |
| 12 | 19,05 | 21,1 | 17,5 | 13,5 | 11,6 | 20,6 | 26,6 | 3,05 | 12,3 | |
| 14 | 22,23 | 21,1 | 20,6 | 13,5 | 11,6 | 23,0 | 29,0 | 3,05 | 12,3 | |
| 16 | 25,40 | 21,1 | 23,8 | 13,5 | 11,6 | 24,6 | 31,3 | 3,05 | 12,3 | |
| 18 | 28,58 | 21,1 | 27,0 | 13,5 | 11,6 | 27,0 | 33,7 | 3,05 | 12,3 | |
| 20 | 31,75 | 22,7 | 30,2 | 16,5 | 14,25 | 29,4 | 36,9 | 3,05 | 10,8 | |
| 22 | 34,93 | 22,7 | 33,4 | 16,5 | 14,25 | 31,8 | 40,1 | 3,05 | 10,8 | |
| 24 | 38,10 | 22,7 | 36,5 | 17,3 | 15,1 | 34,9 | 43,3 | 3,75 | 10,0 | |

* See page 5, 7 and 8 for ordering number information

◆ in series KPSE only contact arrangements 8-3A and 8-33 available

Thru-bulkhead receptacles

KPTB/MS3119

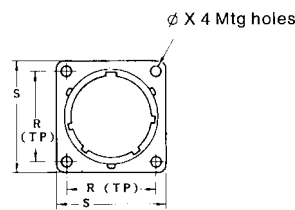
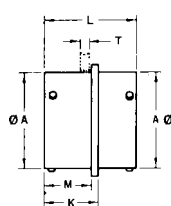

KPTB/MS3119

Receptacle assembly

| | Ø A | K | L | M | T | R | S | X |
|-------------|-------------|------|------|-------|------|-------|------|-------|
| Shell size* | +0,03 -0,13 | ±0,5 | max. | ±0,25 | max. | ±0,15 | max. | ±0,15 |
| ◆8 | 12,00 | 16,1 | 28,6 | 14,5 | 6,0 | 15,1 | 21,0 | 3,05 |
| 10 | 15,00 | 16,1 | 28,6 | 14,5 | 6,0 | 18,3 | 24,2 | 3,05 |
| 12 | 19,05 | 16,1 | 28,6 | 14,5 | 6,0 | 20,6 | 26,6 | 3,05 |
| 14 | 22,23 | 16,1 | 28,6 | 14,5 | 6,0 | 23,0 | 29,0 | 3,05 |
| 16 | 25,40 | 16,1 | 28,6 | 14,5 | 6,0 | 24,6 | 31,3 | 3,05 |
| 18 | 28,58 | 16,1 | 28,6 | 14,5 | 6,0 | 27,0 | 33,7 | 3,05 |
| 20 | 31,75 | 20,1 | 31,9 | 17,7 | 9,2 | 29,4 | 36,9 | 3,05 |
| 22 | 34,93 | 20,1 | 31,9 | 17,7 | 9,2 | 31,8 | 40,1 | 3,05 |
| 24 | 38,10 | 20,1 | 31,9 | 17,7 | 8,0 | 34,9 | 43,3 | 3,75 |

* See page 5, 7 and 8 for ordering number information

◆ in series KPSE only contact arrangements 8-3A and 8-33 available

Straight plugs

KPT06/MS3116 KPSE06/MS3126

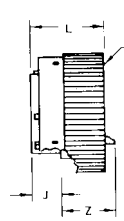
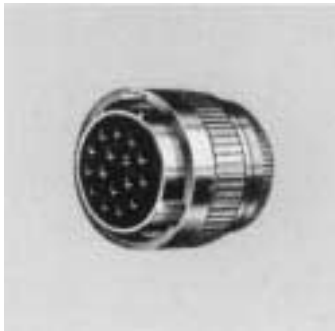

Solder
KPT06/MS3116

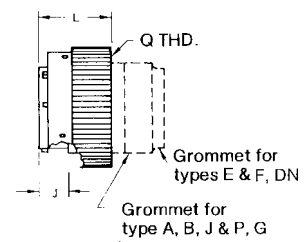
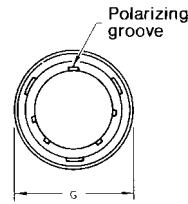

Crimp
KPSE06/MS3126

Without termination assemblies

| Shell size* | KPT/KPSE | J L | Q Thread | KPT | max. |
|-------------|----------|------------|----------|---------------------|------|
| | G | $\pm 0,15$ | max. | Z Thread Type 2A | |
| 8 | 19,8 | 9,1 | 21,4 | 7/16-28UNEF | 16,3 |
| 10 | 23,6 | 9,1 | 21,4 | 9/16-24UNEF | 16,3 |
| 12 | 26,5 | 9,1 | 21,4 | 11/16-24UNEF | 16,3 |
| 14 | 30,1 | 9,1 | 21,4 | 13/16-20UNEF | 16,3 |
| 16 | 33,2 | 9,1 | 21,4 | 15/16-20UNEF | 16,3 |
| 18 | 35,4 | 9,1 | 21,4 | 1- 1/16-18UNEF | 16,3 |
| 20 | 39,0 | 10,7 | 25,1 | 1- 3/16-18UNEF | 15,0 |
| 22 | 42,1 | 10,7 | 25,1 | 1- 5/16-18UNEF | 15,0 |
| 24 | 45,2 | 10,7 | 25,1 | 1- 7/16-18UNEF | 15,0 |

With termination assemblies

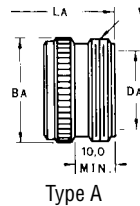

Type A

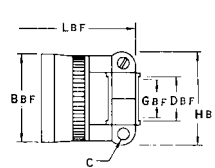

Type B or F

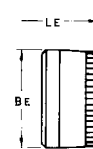

Type E

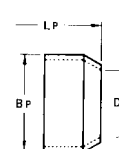

Type P

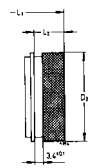

Mod. DN or F 185

| Shell size* | Type A | | | | Type B and F | | | | | | |
|-------------|---------------------|---------------------|---------------------|---------------------|----------------------|-------------|----------------------|----------------------|----------------------|----------------------|--|
| | B _A max. | D _A min. | L _A max. | V Thread Type 2A | B _{BF} max. | C Thread | D _{BF} min. | G _{BF} min. | H _{BF} max. | L _{BF} max. | |
| 8 | 15,0 | 8,5 | 42,0 | 1/2-28UNEF | 14,0 | 6-32 | 6,0 | 2,9 | 19,3 | 46,0 | |
| 10 | 18,2 | 11,8 | 42,0 | 5/8-24UNEF | 17,2 | 6-32 | 7,5 | 4,5 | 20,8 | 46,0 | |
| 12 | 21,2 | 15,0 | 42,0 | 3/4-20UNEF | 20,4 | 6-32 | 10,7 | 7,7 | 24,4 | 46,0 | |
| 14 | 24,6 | 17,9 | 42,0 | 7/8-20UNEF | 23,6 | 6-32 | 13,9 | 9,3 | 27,2 | 46,0 | |
| 16 | 27,7 | 21,1 | 42,0 | 1-20UNEF | 26,7 | 6-32 | 15,5 | 12,4 | 28,7 | 49,0 | |
| 18 | 30,9 | 24,1 | 42,0 | 1-3/16-18UNEF | 29,5 | 8-32 | 19,6 | 15,6 | 35,3 | 49,0 | |
| 20 | 33,9 | 26,5 | 45,0 | 1-3/16-18UNEF | 32,7 | 8-32 | 19,6 | 15,6 | 35,3 | 49,0 | |
| 22 | 37,1 | 30,4 | 45,0 | 1-7/16-18UNEF | 35,9 | 8-32 | 23,6 | 18,8 | 39,9 | 49,0 | |
| 24 | 40,3 | 32,8 | 45,0 | 1-7/16-18UNEF | 39,0 | 8-32 | 25,2 | 20,1 | 43,2 | 49,0 | |

| Shell size* | Type E | | Type P | | | Mod. DN or F 185 | | |
|-------------|---------------------|---------------------|---------------------|---------------------|---------------------|------------------|---------|------|
| | B _E max. | L _E max. | B _P max. | D _P min. | L _P max. | D2 | L1 max. | L2 |
| 8 | 14,2 | 32,5 | 15,3 | 8,3 | 36,9 | 15,6 | 35,0 | 12,2 |
| 10 | 17,2 | 32,5 | 17,6 | 11,3 | 36,9 | 18,4 | 35,0 | 12,2 |
| 12 | 20,4 | 32,5 | 21,6 | 14,2 | 36,9 | 23,7 | 35,0 | 12,2 |
| 14 | 23,4 | 32,5 | 24,3 | 17,3 | 36,9 | 24,5 | 35,0 | 12,2 |
| 16 | 26,6 | 32,5 | 27,6 | 20,5 | 36,9 | 29,8 | 37,0 | 14,5 |
| 18 | 29,6 | 32,5 | 31,0 | 23,1 | 36,9 | 32,0 | 37,0 | 14,5 |
| 20 | 32,8 | 34,5 | 34,3 | 26,3 | 42,2 | 36,1 | 42,0 | 15,8 |
| 22 | 36,0 | 34,5 | 37,1 | 29,4 | 42,2 | 38,5 | 42,0 | 15,8 |
| 24 | 39,2 | 34,5 | 40,5 | 32,6 | 43,9 | 41,6 | 42,0 | 14,9 |

* See page 5, 7 and 8 for ordering number information

◆ in series KPSE only contact arrangements 8-3A and 8-33 available

Jam nut receptacle

KPT07/MS3114 KPSE07/MS3124

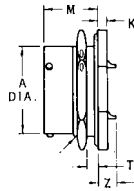
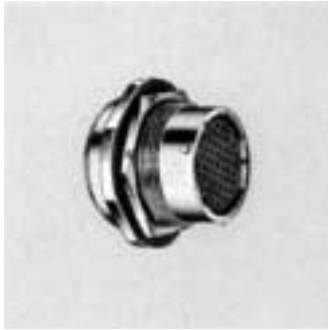

Solder
KPT07/MS3114 Type A

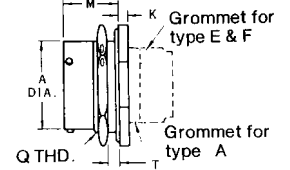
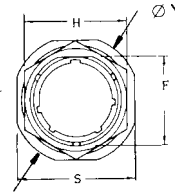

Crimp
KPSE07/MS3124

Without termination assemblies

| Shell size* | KPT/KPSE | | H | K | M | R | S | T Panel thickness | | Ø Y | Z |
|-------------|-------------|-------|-------|-------|-------|----------------|------|-------------------|------|------|------|
| | A | F | | | | | | min. | max. | | |
| ◆8 | +0,03 -0,13 | ±0,15 | ±0,15 | ±0,25 | ±0,15 | Thread Type 2A | ±0,5 | min. | max. | max. | max. |
| 10 | 12,0 | 13,3 | 19,0 | 3,2 | 17,7 | 9/16-24UNEF | 24,0 | 1,6 | 3,5 | 28,0 | 7,9 |
| 12 | 15,0 | 16,5 | 22,2 | 3,2 | 17,7 | 11/16-24UNEF | 27,0 | 1,6 | 3,5 | 31,0 | 7,9 |
| 14 | 19,05 | 20,6 | 27,0 | 3,2 | 17,7 | 7/8-20UNEF | 32,0 | 1,6 | 3,5 | 36,0 | 7,9 |
| 16 | 22,23 | 23,8 | 30,2 | 3,2 | 17,7 | 1-20UNEF | 35,0 | 1,6 | 3,5 | 39,0 | 7,9 |
| 18 | 25,40 | 26,9 | 33,3 | 3,2 | 17,7 | 1-1/8-18UNEF | 38,5 | 1,6 | 3,5 | 42,0 | 7,9 |
| 20 | 28,58 | 30,1 | 36,5 | 3,2 | 17,7 | 1-1/4-18UNEF | 41,5 | 1,6 | 3,5 | 45,0 | 7,9 |
| 22 | 31,75 | 33,3 | 39,7 | 4,0 | 22,5 | 1-3/8-18UNEF | 46,0 | 1,6 | 6,5 | 50,0 | 4,7 |
| 24 | 34,93 | 36,5 | 42,9 | 4,0 | 22,5 | 1-1/2-18UNEF | 49,5 | 1,6 | 6,5 | 55,0 | 4,7 |
| 24 | 38,10 | 39,6 | 46,0 | 4,0 | 23,3 | 1-5/8-18UNEF | 52,5 | 1,6 | 6,5 | 57,0 | 3,8 |

* See page 5, 7 and 8 for ordering number information

◆ in series KPSE only contact arrangements 8-3A and 8-33 available

With termination assemblies

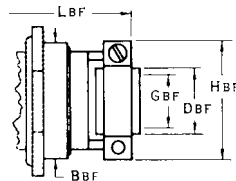

Type B or F

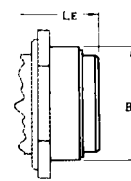

Type E

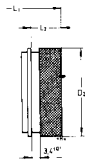

Modification
DN or F 185

| Shell size* | Type B and F | | | | Type E | | Type DN | | | |
|-------------|----------------------|----------------------|----------------------|----------------------|----------------------|---------------------|---------------------|---------------------|---------------------|---------------------|
| | B _{BF} max. | D _{BF} min. | G _{BF} min. | H _{BF} max. | L _{BF} max. | B _E max. | L _E max. | L ₁ max. | L ₂ ±0,5 | D ₂ max. |
| ◆8 | 18,2 | 6,0 | 2,9 | 19,3 | 44,9 | 18,2 | 33,5 | 43,0 | 12,2 | 15,6 |
| 10 | 21,5 | 7,5 | 4,5 | 20,8 | 44,9 | 21,5 | 33,5 | 43,0 | 12,2 | 18,4 |
| 12 | 24,6 | 10,7 | 7,7 | 24,2 | 44,9 | 24,6 | 33,5 | 43,0 | 12,2 | 23,7 |
| 14 | 27,8 | 13,9 | 9,3 | 27,2 | 44,9 | 27,8 | 33,5 | 43,0 | 12,2 | 24,7 |
| 16 | 31,0 | 15,5 | 12,4 | 28,7 | 48,4 | 31,0 | 33,5 | 45,5 | 14,5 | 29,8 |
| 18 | 34,1 | 19,6 | 15,6 | 35,3 | 48,4 | 34,1 | 33,5 | 45,5 | 14,5 | 32,0 |
| 20 | 38,1 | 19,6 | 15,6 | 35,3 | 50,3 | 38,1 | 39,0 | 52,6 | 15,8 | 36,1 |
| 22 | 41,3 | 23,6 | 18,8 | 39,8 | 50,3 | 41,3 | 39,0 | 52,6 | 15,8 | 28,5 |
| 24 | 44,5 | 25,2 | 20,1 | 43,2 | 50,3 | 44,5 | 39,0 | 51,6 | 14,9 | 41,6 |

* See page 5, 7 and 8 for ordering number information

◆ in series KPSE only contact arrangements 8-3A and 8-33 available

Right angle plug, 90°

KPT08 KPSE08

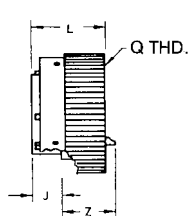

Solder
KPT08

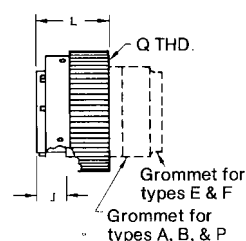
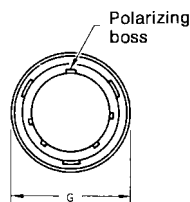

Crimp
KPSE08

Without termination assemblies

| Shell size* | KPT/KPSE | J | L max. | Q | KPT |
|-------------|----------|------|--------|----------------|--------|
| | G | | | | Z max. |
| 8 | 19,8 | 9,1 | 21,4 | 7/16-28UNEF | 16,3 |
| 10 | 23,6 | 9,1 | 21,4 | 9/16-24UNEF | 16,3 |
| 12 | 26,5 | 9,1 | 21,4 | 11/16-24UNEF | 16,3 |
| 14 | 30,1 | 9,1 | 21,4 | 13/16-20UNEF | 16,3 |
| 16 | 33,2 | 9,1 | 21,4 | 15/16-20UNEF | 16,3 |
| 18 | 35,4 | 9,1 | 21,4 | 1- 1/16-18UNEF | 16,3 |
| 20 | 39,0 | 10,7 | 25,1 | 1- 3/16-18UNEF | 15,0 |
| 22 | 42,1 | 10,7 | 25,1 | 1- 5/16-18UNEF | 15,0 |
| 24 | 45,2 | 10,7 | 25,1 | 1- 7/16-18UNEF | 15,0 |

* See page 5, 7 and 8 for ordering number information ◆in series KPSE only contact arrangements 8-3A and 8-33 available

With termination assemblies

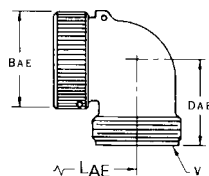

Typ A or E

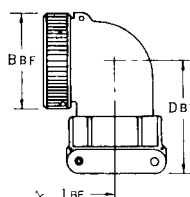

Type B or F

| Shell size* | Typ A and E | | | | Type B and F | | | |
|-------------|----------------------|----------------------|----------------------|---------------|----------------------|----------------------|----------------------|--|
| | B _{AE} max. | L _{AE} max. | D _{AE} max. | V | B _{BF} max. | D _{BF} max. | L _{BF} max. | |
| 8 | 15,6 | 36,1 | 20,9 | 1/2-28UNEF | 15,6 | 31,4 | 36,1 | |
| 10 | 18,9 | 38,3 | 21,7 | 5/8-24UNEF | 18,9 | 32,2 | 38,3 | |
| 12 | 21,2 | 40,9 | 23,3 | 3/4-20UNEF | 21,2 | 35,4 | 40,9 | |
| 14 | 24,8 | 41,6 | 24,9 | 7/8-20UNEF | 24,8 | 38,6 | 41,6 | |
| 16 | 27,7 | 42,5 | 26,5 | 1-20UNEF | 27,7 | 40,2 | 42,5 | |
| 18 | 31,4 | 44,7 | 28,1 | 1-3/16-18UNEF | 31,4 | 41,8 | 44,7 | |
| 20 | 34,7 | 48,3 | 29,6 | 1-3/16-18UNEF | 34,7 | 43,4 | 48,3 | |
| 22 | 36,9 | 52,1 | 31,7 | 1-7/16-18UNEF | 36,9 | 47,9 | 52,1 | |
| 24 | 41,1 | 52,1 | 33,6 | 1-7/16-18UNEF | 41,1 | 49,9 | 52,1 | |

* See page 5, 7 and 8 for ordering number information ◆in series KPSE only contact arrangements 8-3A and 8-33 available

Special versions with grounding continuity

These connectors are designed to ensure electrical continuity

- at the cable shielding level
(to protect it against radio frequency interferences)
- at the grounding level
(if it is connected to the shielding).

The plugs are manufactured with grounding fingers soldered to the front face of the shell. They make contact with the inner side of the receptacle shell.

Plug and receptacle feature a special endbell which supports the cable shielding. The connectors are in accordance with the VG 95328 specification.

Receptacle with grounding continuity (for shielded cable)

KPT/KPSE 0E ... DZ

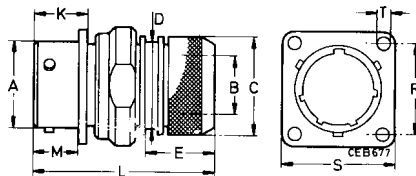

| Shell size* | A | B | C | D | E | K | L | M | R | S | ØT |
|-------------|-------------|------|------|------|------|-------|------|-------|-------|------|-------|
| | +0,03 -0,13 | min. | +0,5 | max. | 1,00 | ±0,25 | max. | ±0,15 | ±0,15 | max. | ±0,15 |
| ◆8 | 12,00 | 6,6 | 16,0 | 13,3 | 15,0 | 13,5 | 52,0 | 11,6 | 15,1 | 21,0 | 3,05 |
| 10 | 15,00 | 9,2 | 18,0 | 16,1 | 15,0 | 13,5 | 52,0 | 11,6 | 18,3 | 24,2 | 3,05 |
| 12 | 19,05 | 12,2 | 22,0 | 20,0 | 17,0 | 13,5 | 52,0 | 11,6 | 20,6 | 26,6 | 3,05 |
| 14 | 22,23 | 15,2 | 25,0 | 22,2 | 18,0 | 13,5 | 53,0 | 11,6 | 23,0 | 29,0 | 3,05 |
| 16 | 25,40 | 18,3 | 28,0 | 26,2 | 18,0 | 13,5 | 53,0 | 11,6 | 24,6 | 31,3 | 3,05 |
| 18 | 28,58 | 20,0 | 32,0 | 28,5 | 18,0 | 13,5 | 53,0 | 11,6 | 27,0 | 33,7 | 3,05 |
| 20 | 31,75 | 23,0 | 34,0 | 32,5 | 18,0 | 16,5 | 58,0 | 14,25 | 29,4 | 36,9 | 3,05 |
| 22 | 34,93 | 26,0 | 38,0 | 34,8 | 18,0 | 16,5 | 58,0 | 14,25 | 31,7 | 40,1 | 3,05 |
| 24 | 38,10 | 28,8 | 41,0 | 37,9 | 18,0 | 17,3 | 58,0 | 15,1 | 34,9 | 43,3 | 3,75 |

* See pages 5 and 8 for ordering number information

◆in series KPSE only contact arrangements 8-3A and 8-33 available

Cable connecting plug with grounding continuity (for shielding cable)

KPT/KPSE 1E ... DZ

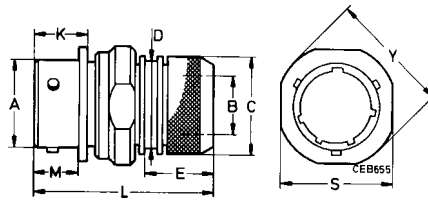

| Shell size* | A +0,03 -0,13 | B min. | C +0,50 | D max. | E ±1,0 | K ±0,25 | L max. | M ±0,15 | S max. | Ø Y max. |
|-------------|------------------|-----------|------------|-----------|-----------|------------|-----------|------------|-----------|-------------|
| ◆8 | 12,00 | 6,6 | 16,0 | 13,3 | 15,0 | 13,5 | 52,0 | 11,6 | 18,5 | 21,0 |
| 10 | 15,00 | 9,2 | 18,0 | 16,1 | 15,0 | 13,5 | 52,0 | 11,6 | 23,0 | 24,2 |
| 12 | 19,05 | 12,2 | 22,0 | 20,0 | 17,0 | 13,5 | 52,0 | 11,6 | 29,0 | 26,6 |
| 14 | 22,23 | 15,2 | 25,0 | 22,2 | 18,0 | 13,5 | 53,0 | 11,6 | 29,5 | 29,0 |
| 16 | 25,40 | 18,3 | 28,0 | 26,2 | 18,0 | 13,5 | 53,0 | 11,6 | 32,0 | 31,3 |
| 18 | 28,58 | 20,0 | 32,0 | 28,5 | 18,0 | 13,5 | 53,0 | 11,6 | 35,0 | 33,7 |
| 20 | 31,75 | 23,0 | 34,0 | 32,5 | 18,0 | 16,5 | 58,0 | 14,25 | 38,5 | 36,9 |
| 22 | 34,93 | 26,0 | 38,0 | 34,8 | 18,0 | 16,5 | 58,0 | 14,25 | 42,0 | 40,1 |
| 24 | 38,10 | 28,8 | 41,0 | 37,9 | 18,0 | 17,5 | 58,0 | 15,10 | 46,0 | 43,3 |

* See pages 5 and 8 for ordering number information ◆in series KPSE only contact arrangements 8-3A and 8-33 available

Straight plug with grounding continuity

KPT/KPSE6E.DZ

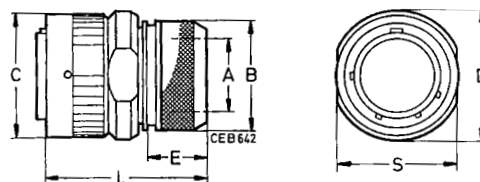

| Shell size* | A min. | B +0,50 | C max. | D max. | E ±1,0 | L max. | S ±0,2 |
|-------------|-----------|------------|-----------|-----------|-----------|-----------|-----------|
| ◆8 | 6,6 | 16,0 | 19,1 | 20,0 | 15,0 | 48,0 | 17,0 |
| 10 | 9,2 | 18,0 | 22,0 | 15,0 | 15,0 | 48,0 | 19,0 |
| 12 | 12,2 | 22,0 | 26,2 | 17,0 | 17,0 | 48,0 | 23,0 |
| 14 | 15,2 | 25,0 | 29,4 | 30,0 | 18,0 | 49,0 | 26,0 |
| 16 | 18,3 | 28,0 | 32,8 | 33,0 | 18,0 | 49,0 | 29,0 |
| 18 | 20,0 | 32,0 | 35,4 | 36,0 | 18,0 | 49,0 | 33,0 |
| 20 | 23,0 | 34,0 | 39,0 | 40,0 | 18,0 | 53,0 | 35,0 |
| 22 | 26,0 | 38,0 | 42,1 | 43,0 | 18,0 | 53,0 | 39,0 |
| 24 | 28,8 | 41,0 | 45,2 | 46,0 | 18,0 | 53,0 | 42,0 |

* See pages 5 and 8 for ordering number information ◆in series KPSE only contact arrangements 8-3A and 8-33 available

Jam nut receptacle with grounding continuity (for shielded cable)

KPT/KPSE 7E ... DZ

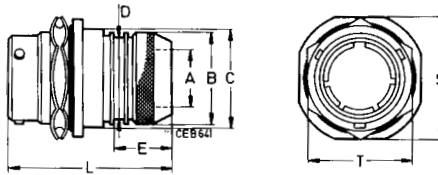

| Shell-size | Ø A min. | Ø B +0,5 | Ø C max. | D max. | E 1,0 | L max. | S ±0,25 | T ±0,25 |
|------------|-------------|-------------|-------------|-----------|----------|-----------|------------|------------|
| ◆8 | 6,6 | 16,0 | 18,2 | 13,3 | 15,0 | 47,0 | 23,0 | 19,0 |
| 10 | 9,2 | 18,0 | 21,4 | 16,1 | 15,0 | 47,0 | 27,0 | 22,2 |
| 12 | 12,2 | 22,0 | 24,6 | 20,0 | 17,0 | 49,0 | 31,7 | 27,0 |
| 14 | 15,2 | 25,0 | 27,8 | 22,2 | 18,0 | 50,0 | 34,9 | 30,2 |
| 16 | 18,3 | 28,0 | 30,9 | 26,2 | 18,0 | 50,0 | 38,1 | 33,3 |
| 18 | 20,0 | 32,0 | 34,1 | 28,5 | 18,0 | 50,0 | 41,3 | 36,5 |
| 20 | 23,0 | 34,0 | 38,1 | 32,5 | 18,0 | 55,0 | 46,0 | 39,7 |
| 22 | 26,0 | 38,0 | 41,3 | 34,8 | 18,0 | 55,0 | 49,2 | 42,9 |
| 24 | 28,8 | 41,0 | 44,4 | 37,9 | 18,0 | 55,0 | 52,3 | 46,0 |

* See pages 5 and 8 for ordering number information

◆in series KPSE only contact arrangements 8-3A and 8-33 available

Assembly of a connector with a ground continuity endbell

KPT/KPSE ... DZ

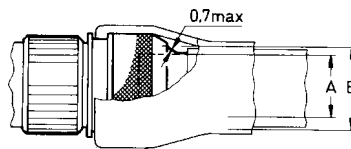
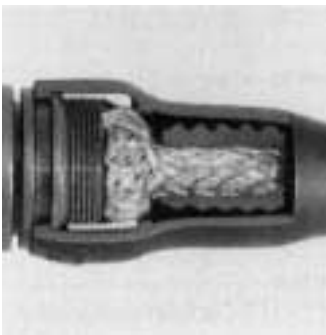

| Shell size* | ± A max. | ± B max. |
|-------------|-------------|-------------|
| ◆8 | 6,6 | 8,0 |
| 10 | 9,2 | 10,0 |
| 12 | 12,2 | 14,0 |
| 14 | 15,2 | 17,0 |
| 16 | 18,3 | 20,0 |
| 18 | 20,0 | 24,0 |
| 20 | 23,0 | 27,0 |
| 22 | 26,0 | 30,0 |
| 24 | 28,8 | 33,0 |

* See pages 5 and 8 for ordering number information

◆in series KPSE only contact arrangements 8-3A and 8-33 available

Receptacles with straight solder pins

How to order

| | KPT | 2 | E | 22 | - | 36 | P | W | * |
|--|-----|---|---|----|---|----|---|---|---|
| Series _____ KPT – ITT Cannon designation | | | | | | | | | |
| Shell type _____ ITT Cannon designation 2 – box mounting receptacle (only class E), not layout 14 A 4 7 – jam nut receptacle (hermetic version also available) | | | | | | | | | |
| Class _____ A – general duty (shell type 7 only) E – with grommet seal, not for 02 and 3112 (MS-Spezifikation), only shell type 2 | | | | | | | | | |
| Shell size _____ 8, 10, 12, 14, 16, 18, 20, 22 und 24 | | | | | | | | | |
| Contact arrangements _____ see page 9 – 11 | | | | | | | | | |
| Contact type _____ P – pin S – socket | | | | | | | | | |
| Alternate insert position _____ W, X, Y and Z (omit for normal position) see page 12 | | | | | | | | | |
| Modification _____ EW – solder pin 0,6 x 7 mm EX – solder pin 0,76 x 7 mm | | | | | | | | | |

Box mounting receptacle

KPT 2* P/S** .***

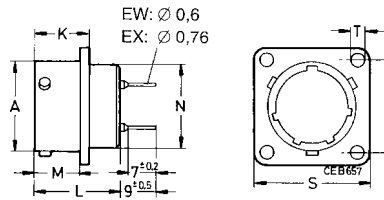

| Shell size | A | K | L | M | N | R | S | $\varnothing T$ |
|------------|-------------|------------|------|------------|-------|------------|-------|-----------------|
| | +0,03 -0,13 | $\pm 0,25$ | max. | $\pm 0,15$ | max. | $\pm 0,15$ | max. | $\pm 0,15$ |
| 8 | 12,00 | 13,50 | 21,1 | 11,60 | 11,10 | 15,10 | 21,00 | 3,05 |
| 10 | 15,00 | 13,50 | 21,1 | 11,60 | 14,30 | 18,30 | 24,20 | 3,05 |
| 12 | 19,05 | 13,50 | 21,1 | 11,60 | 17,50 | 20,60 | 26,60 | 3,05 |
| 14 | 22,23 | 13,50 | 21,1 | 11,60 | 20,60 | 23,00 | 29,00 | 3,05 |
| 16 | 25,40 | 13,50 | 21,1 | 11,60 | 23,80 | 24,60 | 31,30 | 3,05 |
| 18 | 28,58 | 13,50 | 21,1 | 11,60 | 27,00 | 27,00 | 33,70 | 3,05 |
| 20 | 31,75 | 16,50 | 22,7 | 14,25 | 30,20 | 29,40 | 36,90 | 3,05 |
| 22 | 34,93 | 16,50 | 22,7 | 14,25 | 33,40 | 31,70 | 40,10 | 3,05 |
| 24 | 38,10 | 17,30 | 22,7 | 15,10 | 36,50 | 34,90 | 43,30 | 3,75 |

Order ref. see page 22

Jam nut receptacle

KPT 7* P/S** .***

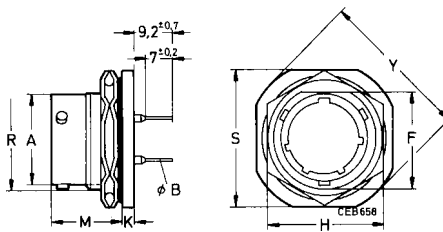

| Shell size* | A | F | H | K | M | R | S | Panel thickness | Y |
|-------------|-------------|------------|------------|------------|------------|-----------------|-----------|-----------------|------|
| | +0,03 -0,13 | $\pm 0,15$ | $\pm 0,15$ | $\pm 0,25$ | $\pm 0,15$ | Thread Type 2 A | $\pm 0,5$ | min. | max. |
| 8 | 12,00 | 13,3 | 19,0 | 3,2 | 17,7 | 9/16-24UNEF | 24,0 | 1,6 | 28,0 |
| 10 | 15,00 | 16,5 | 22,2 | 3,2 | 17,7 | 11/16-24UNEF | 27,0 | 1,6 | 31,0 |
| 12 | 19,05 | 20,6 | 27,0 | 3,2 | 17,7 | 7/8-20UNEF | 32,0 | 1,6 | 36,0 |
| 14 | 22,23 | 23,8 | 30,2 | 3,2 | 17,7 | 1- 20UNEF | 35,0 | 1,6 | 39,0 |
| 16 | 25,40 | 26,9 | 33,3 | 3,2 | 17,7 | 1- 1/8-18UNEF | 38,5 | 1,6 | 42,0 |
| 18 | 28,58 | 30,1 | 36,5 | 3,2 | 17,7 | 1- 1/4-18UNEF | 41,5 | 1,6 | 45,0 |
| 20 | 31,75 | 33,3 | 39,7 | 4,0 | 22,5 | 1- 3/8-18UNEF | 46,0 | 1,6 | 50,0 |
| 22 | 34,93 | 36,5 | 42,9 | 4,0 | 22,5 | 1- 1/2-18UNEF | 49,5 | 1,6 | 55,0 |
| 24 | 38,10 | 39,6 | 46,0 | 4,0 | 23,3 | 1- 5/8-18UNEF | 52,5 | 1,6 | 57,0 |

Order ref. see page 22

Panel cutouts

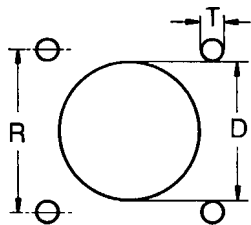

Box and wall mounting receptacle

| Shell size | for rear mounting | for front mounting | |
|------------|-------------------|--------------------|--------------|
| | $D +0,25 / -0$ | $D +0,25 / -0$ | $R \pm 0,15$ |
| 8 | 14 | 12,7 | 15,1 |
| 10 | 17 | 16 | 18,3 |
| 12 | 22 | 19 | 20,6 |
| 14 | 25 | 22,2 | 23,0 |
| 16 | 28 | 25,5 | 24,6 |
| 18 | 31 | 28,5 | 27,0 |
| 20 | 34,5 | 31,7 | 29,4 |
| 22 | 37,5 | 35 | 31,8 |
| 24 | 41 | 38 | 34,9 |

Mounting hole diameter

| Shell size | KPT/KPSE | P - Panel thickness |
|------------|----------|----------------------------|
| | $T +0,3$ | screw head height included |
| 8 | 3,1 | 2,2 |
| 10 | 3,1 | 2,2 |
| 12 | 3,1 | 2,2 |
| 14 | 3,1 | 2,2 |
| 16 | 3,1 | 2,2 |
| 18 | 3,1 | 2,2 |
| 20 | 3,1 | 5,4 |
| 22 | 3,1 | 5,4 |
| 24 | 3,6 | 5,4 |

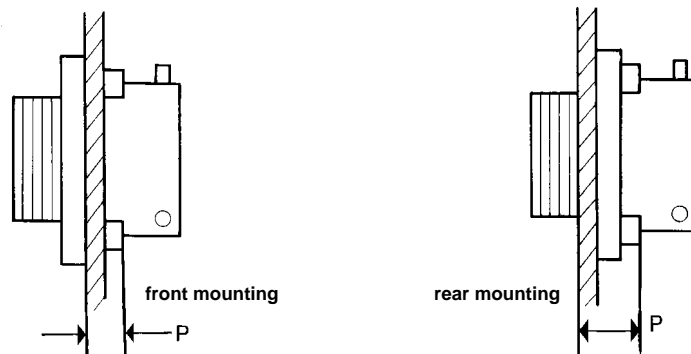

Jam nut receptacle

| Shell size | KPT/KPSE | |
|------------|----------------|----------------|
| | $A +0,25 / -0$ | $B +0 / -0,12$ |
| 8 | 14,5 | 13,6 |
| 10 | 17,7 | 16,8 |
| 12 | 22,7 | 20,9 |
| 14 | 25,7 | 24,1 |
| 16 | 28,8 | 27,2 |
| 18 | 32 | 30,4 |
| 20 | 35,1 | 33,6 |
| 22 | 38,4 | 36,8 |
| 24 | 41,5 | 40 |

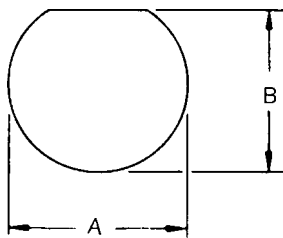

Dummy receptacles

How to order

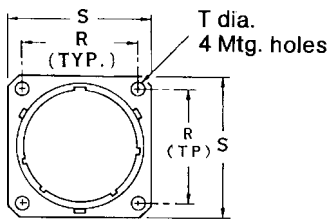
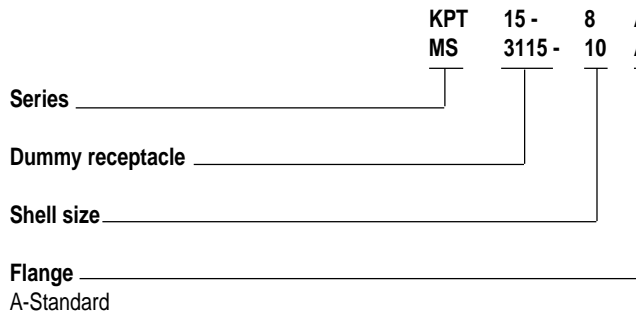

| Shell size | A | K | M | R | S | Ø T |
|------------|-------------|------|-------|-------|------|-------|
| | +0,03 -0,13 | ±0,4 | ±0,15 | ±0,15 | max. | ±0,15 |
| * 8 A | 12,00 | 1,6 | 12,1 | 15,1 | 21,0 | 3,05 |
| * 10 A | 15,00 | 1,6 | 12,1 | 18,3 | 24,2 | 3,05 |
| * 12 A | 19,05 | 1,6 | 12,1 | 20,6 | 26,6 | 3,05 |
| * 14 A | 22,23 | 1,6 | 12,1 | 23,0 | 29,0 | 3,05 |
| * 16 A | 25,40 | 1,6 | 12,1 | 24,6 | 31,3 | 3,05 |
| * 18 A | 28,58 | 1,6 | 12,1 | 27,0 | 33,7 | 3,05 |
| * 20 A | 31,75 | 2,4 | 14,5 | 29,4 | 36,9 | 3,05 |
| * 22 A | 34,93 | 2,4 | 14,5 | 31,8 | 40,1 | 3,05 |
| * 24 A | 38,10 | 2,4 | 15,4 | 34,9 | 43,3 | 3,75 |

* Add KPT 15 or MS 3115 prefixes

Protective caps

Material and finishes

| | |
|-----------------|----------------------------------|
| Protective cap | Aluminum alloy |
| Sash chain | Stainless steel |
| Cord | Polyamide |
| Ring | Stainless steel |
| Clip | Aluminum alloy |
| Gasket | Fluor Silicone |
| Endlink / rivet | Stainless steel, passivated |
| Bayonet pin | Stainless steel, passivated |
| Finishes | |
| A34 | Nickel |
| A66 | Olive drab chromate over cadmium |

How to order

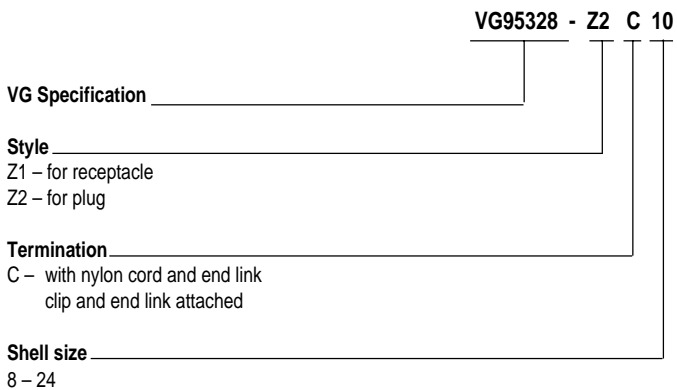
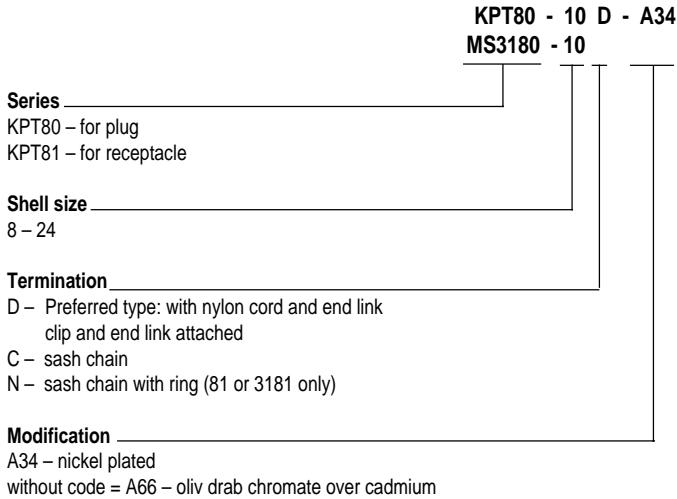

Crimp tool for clips upon request

80 / 3180 – for plugs
cap with sash chain C or N

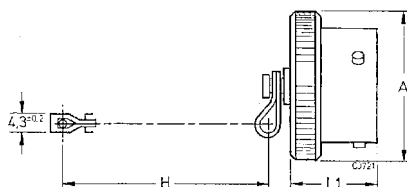

80 / 3180 – for plugs
cap with nylon cord D / preferred type

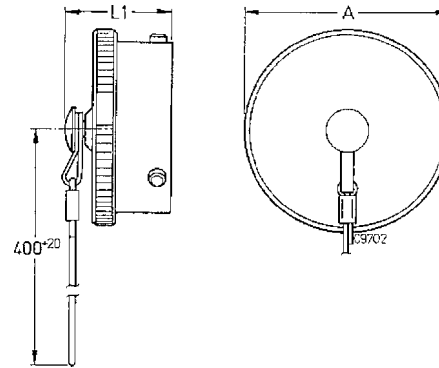

81 / 3181 – for receptacles
cap with nylon cord D / preferred type

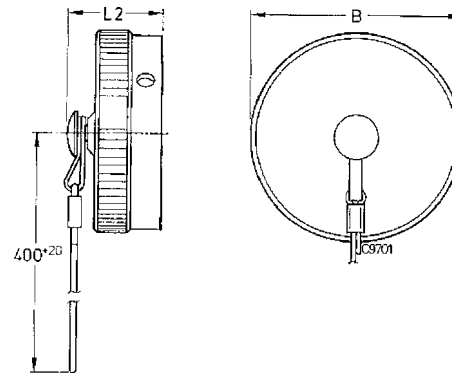

| Shell | A size | L1 max. | B max. | L2 max. | H max. | N |
|-------|--------|---------|--------|---------|--------|------|
| 8 | 18,26 | 19,84 | 18,0 | 21,44 | 76 | 14,7 |
| 10 | 21,44 | 19,84 | 20,3 | 21,44 | 76 | 17,9 |
| 12 | 25,40 | 19,84 | 25,1 | 21,44 | 89 | 22,6 |
| 14 | 28,58 | 19,84 | 28,2 | 21,44 | 89 | 25,8 |
| 16 | 31,75 | 19,84 | 31,5 | 21,44 | 89 | 29,0 |
| 18 | 34,92 | 19,84 | 34,5 | 21,44 | 89 | 32,2 |
| 20 | 38,10 | 21,44 | 37,8 | 21,44 | 101 | 35,3 |
| 22 | 41,28 | 21,44 | 40,9 | 21,44 | 101 | 38,5 |
| 24 | 44,45 | 22,22 | 44,2 | 22,22 | 101 | 41,7 |

81 / 3181 – for receptacles
cap with sash chain C or N

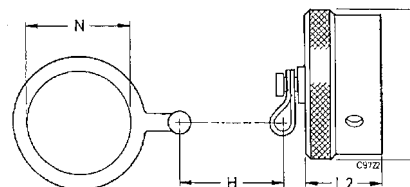

Tools and Accessories

Crimp tools



| Series | Hand crimp tool | Locator for contact sizes 20, 16 and 12 | Test gage for Hand crimp tool |
|--------|-----------------|---|-------------------------------|
| KPSE | M22520/1-01 | M22520/1-02 | M22520/3-1 |

Insertion/Extraction tool



KPSE

| Contact size | Insertion tool | Extraction tool |
|-------------------------------|----------------|-----------------|
| | MS | ITT Cannon |
| 20 without insulation support | - | CIT-20-18 |
| 20 with insulation support | MS24256A20 | CIT-20-5A |
| 16 | MS24256A16 | CIT-16-1 |
| 12 | MS24256A12 | MS24256R12 |



KPT14A4

| Contact type | Insertion tool | Extraction tool |
|--------------|----------------|-----------------|
| Coaxial | - | CET-C 6 B |

Contacts



KPSE/VG 95328

| Contact size | Contact type | Contact order ref. KPSE version | VG 95328 version |
|--------------|--------------------------------|---------------------------------|------------------|
| 20 | Socket with insulation support | 031-8704-203 | 031-8704-203 |
| | Pin with insulation support | 430-8560-006 | 430-8560-006 |
| 16 | Socket | 031-8704-000 | 031-8704-000 |
| | Pin | 430-8560-004 | 430-8560-004 |
| 12 | Socket | 031-8704-012 | |
| | Pin | 430-8560-016 | |
| | Grounding pin | 430-8560-020 | |

KPT14A4

| Coaxial | Pin | DM 53740-5001 |
|---------|--------|---------------|
| | Socket | DM 53742-5001 |

Wire hole fillers/Grommet sealing plugs



KPSE

| Contact size | Colour code | MS | LN | ITT Cannon |
|--------------|-------------|------------|---------------|--------------|
| 20 | Red | MS3187A20 | BL0,6LN 29500 | 225-1012-000 |
| 16 | Blue | MS3187-16A | BL1,2LN 29500 | 225-1011-000 |
| 12 | Yellow | MS3187-12 | | 225-0072-000 |
| Koax 14A4 | Yellow | | | 225-0018-000 |

Flange gaskets

KPSE

| Shell size | Alu-Flex conductive | Chloroprene non conductive | Shell size | Alu-Flex conductive | Chloroprene non conductive |
|------------|---------------------|----------------------------|------------|---------------------|----------------------------|
| 8 | 075-8543-000 | 075-8543-010 | 18 | 075-8543-005 | 075-8543-015 |
| 10 | 075-8543-001 | 075-8543-011 | 20 | 075-8543-006 | 075-8543-016 |
| 12 | 075-8543-002 | 075-8543-012 | 22 | 075-8543-007 | 075-8543-017 |
| 14 | 075-8543-003 | 075-8543-013 | 24 | 075-8543-008 | 075-8543-018 |
| 16 | 075-8543-004 | 075-8543-014 | | | |

| Contact size | Cable size mm ² (AWG) | Strip insulation |
|--------------|----------------------------------|------------------|
| 20 | 0,93-0,21 (20-24) | 5,0 mm |
| 16 | 1,91-0,60 (16-20) | 6,5 mm |
| 12 | 3,18-1,91 (12-14) | 6,5 mm |
| 14A4 Coax | RG179B/u | |

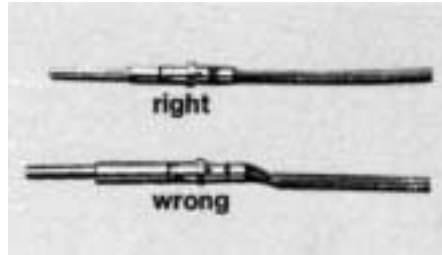

Crimping contacts

1. Strip wires according to the table above taking care not to cut or nick strands.

2. Insert stripped wire into contact crimp pot. Wire must be visible thru inspection hole.

3. Using correct crimp tool and locator, cycle the tool once to be sure the indentors are open. Insert contact and wire into locator. Squeeze tool handles firmly and completely to insure a proper crimp. The tool will not release unless the crimp indentors in the tool head have been fully actuated.

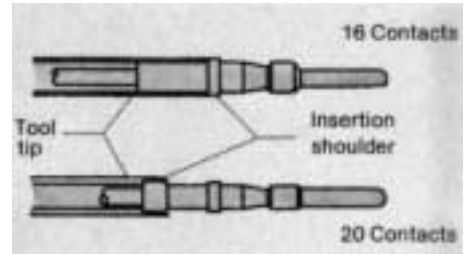
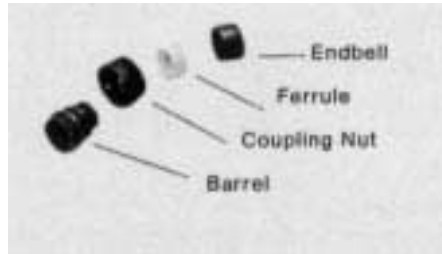
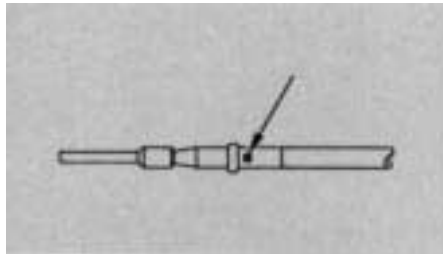

4. Release crimped contact and wire from tool. Be certain the wire is visible thru inspection hole in contact.

Contact insertion

5. Remove hardware from plug and receptacle. Slide hardware over wire bundle in proper order for re-assembly.

6. Use the proper contact insertion tool, and slide the tool over the terminal end of the contact. The size 16 contact lies in the tool and the tool tip butts against the contact shoulder. The rear, or insulation support, of the size 20 contact butts against an internal shoulder in the tool tip.

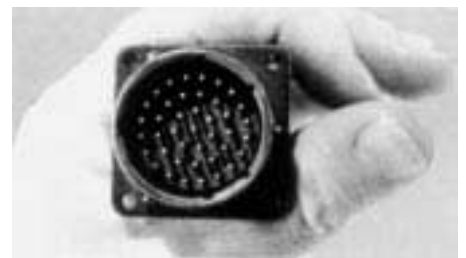
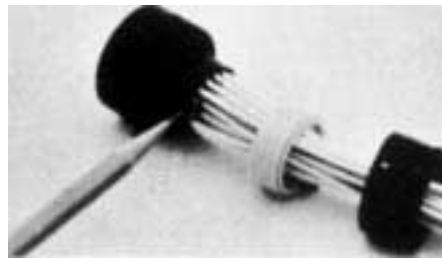

7. Beginning from center cavity and working outwards, insert wired contacts into rear of connector by hand until the front of the contact shoulder is no more than 1/8" from the grommet. Holding the connector securely, position tool behind contact. Push tool straight into contact cavity until contact snaps into position. A light pull on wire will assure that contact is locked securely. Repeat for remaining contacts.

8. Use wire hole fillers or grommet sealing plugs to fill any empty cavities and assemble hardware to rear of plug or receptacle.

Completion

9. Check face of plug or receptacle for proper contact installation.

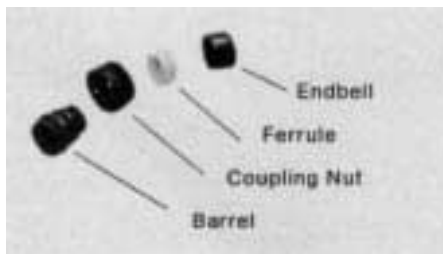

Contact extraction

10. Slide hardware back over wire bundle. Using proper extraction tool or extraction end of proper insertion/extraction tool, proceed as follows:

11. Use the proper extraction tool. There are two lines on the clip sleeve which are vital to the contact removal process. The first index line is used for removing

pin contacts while the second index line is for removing socket contacts. Carefully place the tool tip over the contact to be extracted until the tool tip touches the insulator face. Carefully rotate the tool until the index line is slightly below the insulator face. Keep an even pressure against tool body; push plunger forward with thumb and index finger; and push the contact out through the clip. Carefully remove extraction tool from connector. Pull the wire by hand to complete the removal of the contact.

Please ask for our detailed Assembly Instruction

Cross Reference List KPT/MIL-C-26482, NFL 54125, VG 95328

| Part No. KPT ITT Cannon | Part No. MIL-26482 | Part No. NFL 54125 | Part No. VG 95328 | Part No. LN 29500 |
|----------------------------|-----------------------|-----------------------|----------------------|----------------------|
| KPT00B*.*.* | | 25100A*.*.*50 | | |
| KPT00B*.*.* | | 25100AC*.*.*50 | | |
| KPT00E*.*.* | MS3110E*.*.* | 25100E*.*.*50 | | |
| KPT00F*.*.* | MS3110E*.*.* | 25100EC*.*.*50 | | |
| KPT00G*.*.* | | 25100J*.*.*50 | | |
| KPT00J*.*.* | MS3110J*.*.* | | | |
| KPT00P*.*.* | MS3110P*.*.* | 25100P*.*.*50 | | |
| KPT0E*.*.*DN | | | | |
| KPT0E*.*.*DZ | | | | |
| KPT01A*.*.* | | 25101A*.*.*50 | | |
| KPT01B*.*.* | | 25101AC*.*.*50 | | |
| KPT01E*.*.* | MS3111E*.*.* | 25101E*.*.*50 | | |
| KPT01F*.*.* | MS3111F*.*.* | 25101EC*.*.*50 | | |
| KPT01G*.*.* | | 25101J*.*.*50 | | |
| KPT01J*.*.* | MS3111J*.*.* | | | |
| KPT01P*.*.* | MS3111P*.*.* | 25101P*.*.*50 | | |
| KPT1E*.*.*DN | | | | |
| KPT06A*.*.* | | 25106A*.*.*50 | | |
| KPT06B*.*.* | | 25106AC*.*.*50 | | |
| KPT06E*.*.* | MS3116E*.*.* | 25106E*.*.*50 | | |
| KPT06F*.*.* | MS3116F*.*.* | 25106EC*.*.*50 | | |
| KPT06G*.*.* | | 25106J*.*.*50 | | |
| KPT1E*.*.*DZ | | | | |
| | | 25102E*.*.*50Y11* | | |
| | | 25107A*.*.*50Y11* | | |
| KPT06J*.*.* | MS3116J*.*.* | | | |
| KPT06P*.*.* | MS3116P*.*.* | 25106P*.*.*50 | | |
| KPT6A*.*.*88 | | | | |
| KPT6E*.*.*DN | | | | |
| KPT6E*.*.*DZ | | | | |
| KPT02E*.*.* | MS3112E*.*.* | 25102E*.*.*50 | H*.*.*VG 95328 | |
| KPT07A*.*.* | | 25107A*.*.*50 | | |
| KPT07E*.*.* | MS3114E*.*.* | 25107E*.*.*50 | | |
| KPT07F*.*.* | MS3114F*.*.* | 25107EC*.*.*50 | | |
| KPT08E*.*.* | | | | |
| KPT08F*.*.* | | 25108EC*.*.*50 | | |
| KPT08P*.*.* | | 25108P*.*.*50 | | |
| KPT7E*.*.*DN | | | | |
| KPTB*.*.* | MS3119E*.*.* | 251B*.*.* | | |

Please note: Connectors acc. to VG 95328 and connectors of ITT Cannon series KPSE use different contacts – see page 27

Cross Reference List Protective Caps

| Part No. ITT Cannon | Part No. MIL-C-26482 | Part No. NFL 54125 | Part No. VG95328 | Part No. LN 29500 |
|------------------------|-------------------------|-----------------------|---------------------|----------------------|
| KPT80 | MS 3180 | | | |
| KPT80...C | MS 3180...C | | Z 2...VG 95328 | |
| KPT81 | MS 3181 | | | |
| KPT81...C | MS 3181...C | | Z 1...VG 95328 | |
| KPT81...N | MS 3181...N | | | |

Cross Reference List KPSE/MIL-C-26482, NFL 54125, VG95328

| Part No. KPSE | Part No. | Part No. | Part No. |
|---------------|----------------|----------------|----------------|
| ITT Cannon | MIL-C-26482 | NFL 54-125 | VG 95328 |
| KPSE00A*.*.* | | 25100RA*.*.*50 | |
| KPSE00B*.*.* | | | |
| KPSE00E*.*.* | MS3120E*.*.* | 25100R*.*.*50 | A*.*.*VG 95328 |
| KPSE00F*.*.* | MS3120F*.*.* | 25100RC*.*.*50 | B*.*.*VG 95328 |
| KPSE0E*.*.*DZ | | | R*.*.*VG 95328 |
| KPSE00J*.*.* | | | |
| KPSE00P*.*.* | MS3120P*.*.* | 25100RP*.*.*50 | |
| KPSE0E*.*.*DN | | | |
| KPSE00G*.*.* | | 25106RJ*.*.*50 | |
| KSPE01A*.*.* | 25101RA*.*.*50 | | |
| KPSE01B*.*.* | | | |
| KPSE01E*.*.* | MS3121E*.*.* | 25101R*.*.*50 | |
| KPSE01F*.*.* | MS3121F*.*.* | 25101RC*.*.*50 | |
| KPSE01G*.*.* | | 25101RJ*.*.*50 | |
| KPSE01J*.*.* | | | |
| KPSE01P*.*.* | MS3121P*.*.* | 25101RP*.*.*50 | |
| KPSE*.*.*DN | | | |
| KPSE02E*.*.* | MS3122E*.*.* | 25102R*.*.*50 | C*.*.*VG 95328 |
| KPSE06A*.*.* | | 25106RA*.*.*50 | |
| KPSE06B*.*.* | | | |
| KPSE06E*.*.* | MS3126E*.*.* | 25106R*.*.* | |
| KPSE06F*.*.* | MS3126F*.*.* | 25106RC*.*.*50 | K*.*.*VG 95328 |
| KPSE06G*.*.* | | 25106RJ*.*.*50 | |
| KPSE06J*.*.* | | | |
| KPSE06P*.*.* | MS3126P*.*.* | 25106RP*.*.*50 | |
| KPSE6A*.*.*88 | | | |
| KPSE6E*.*.*88 | | | N*.*.*VG 95328 |
| KPSE6E*.*.*DN | | | J*.*.*VG 9532 |
| KPSE6E*.*.*DZ | | | M*.*.*VG 95328 |
| KPSE07A*.*.* | | 25107RA*.*.*50 | |
| KPSE1E*.*.*DZ | | | |
| KPSE7E*.*.*DN | | | S*.*.*VG 95328 |
| KPSE07E*.*.* | MS3124E*.*.* | 25107R*.*.*50 | D*.*.*VG 95328 |
| KPSE07F*.*.* | MS3124F*.*.* | 25107RC*.*.*50 | E*.*.*VG 95328 |
| KPSE08E*.*.* | | | |
| KPSE08F*.*.* | | 25108RC*.*.*50 | |
| KPSE08P*.*.* | | 25108RP*.*.*50 | |
| KPSE7E*.*.*DZ | | | T*.*.*VG 95328 |

Please note: Connectors acc. to VG 95328 and connectors of ITT Cannon series KPSE use different contacts – see page 27

Product Safety Information

THIS NOTE SHOULD BE READ IN CON-JUNCTION WITH THE PRODUCT DATA SHEET/CATALOGUE. FAILURE TO OB-SERVE THE ADVICE IN THIS INFORMATION SHEET AND THE OPERATING CONDITIONS SPECIFIED IN THE PRODUCT DATA SHEET/ CATALOGUE COULD RESULT IN HAZAR-DUOUS SITUATIONS.

1. MATERIAL CONTENT AND PHYSICAL FORM

Electrical connectors do not usually contain hazardous materials. They contain conducting and non-conducting materials and can be divided into two groups.

a) Printed circuit types and low cost audio types which employ all plastic insulators and casings.

b) Rugged, Fire Barrier and High Reliability types with metal casings and either natural rubber, synthetic rubber, plastic or glass insulating materials.

Contact materials vary with type of connector and also application and are usually manufactured from either copper, alloys, nickel, alumel, chromel or steel. In special applications, other alloys may be specified.

2. FIRE CHARACTERISTICS AND ELECTRIC SHOCK HAZARD

There is no fire hazard when the connector is correctly wired and used within the specified parameters.

Incorrect wiring or assembly of the connector or careless use of metal tools or conductive fluids, or transit damage to any of the component parts may cause electric shock or burns. Live circuits must be broken by separating mated connectors as this may cause arcing, ionisation and burning. Heat dissipation is greater at maximum resistance in a circuit. Hot spots may occur when resistance is raised locally by damage, e.g. cracked or deformed contacts, broken strands of wire. Local overheating may also result from the use of the incorrect application tools or from poor quality soldering or slack screw terminals. Overheating may occur if the ratings in the Product Data Sheet/ Catalogue are exceeded and can cause breakdown of insulation and hence electric shock.

If heating is allowed to continue it intensifies by further increasing the local resistance through loss of temper of spring contacts, formation of oxide film on contacts and wires, and leakage currents through carbonisation of insulation and tracking paths. Fire can then result in the presence of combustible materials and this may release noxious fumes. Overheating may not be visually apparent. Burns may result from touching overheated components.

3. HANDLING

Care must be taken to avoid damage to any component parts of electrical connectors during installation and use. Although there are normally no sharp edges, care must be taken when handling certain components to avoid injury to fingers.

Electrical connectors may be damaged in transit to the customers, and damage may result in creation of hazards. Products should therefore be examined prior to installation/use and rejected if found to be damaged.

4. DISPOSAL

Incineration of certain materials may release noxious or even oxid fumes.

5. APPLICATION

Connectors with exposed contacts should not be selected for use on the current supply side of an electrical circuit, because an electric shock could result from touching exposed contacts on an unmated connector. Voltages in excess of 30 V ac or 42.5 V dc are potentially hazardous and care should be taken to ensure that such voltages can not be transmitted in any way to exposed metal parts of the connector body. The connector and wiring should be checked, before making live, to have no damage to metal parts of insulators, no solder blobs, loose strands, conducting lubricants, swarf, or any other undesired conducting particles. Insulation resistance should be checked to make certain that no low resistance joints or spurious conducting path are existing between contacts and exposed metal parts of the connector body. Further the contact resistance of the connectors should be measured within the electrical circuit in order to identify high resistances which result in excessive connector heating.

Always use the correct application tools as specified in the Data Sheet/Catalogue.

Do not permit untrained personnel to wire, assemble or tramper with connectors.

For operation voltage please see appropriate national regulations

IMPORTANT GENERAL INFORMATION.

1. Air and creepage paths/Operating voltage
The admissible operating voltages depend on the individual applications and the valid national and other applicable safety regulations.

For this reason the air and creepage path data are only reference values. Observe reduction of air and creepage paths due to PC board and/or harnessing.

2. Temperature

All information given are temperature limits. The operation temperature depends on the individual application.

3. Other important information

Cannon continuously endeavours to improve their products. Therefore, Cannon products may deviate from the description, technical data and shape as shown in this catalogue and data sheets.

4. Harnessing and Assembly Instructions

If applicable, our special harnessing and/or assembly instruction has to be adhered to. This is provided at request.

ITT Cannon manufactures the highest quality products available in the marketplace; however these products are intended to be used in accordance with the specifications in this catalog. Any use or application that deviates from stated operating specifications is not recommended and may be unsafe. No information and data contained in this catalog shall be construed to create any liability on the part of ITT Cannon. Any new issue of this catalog shall automatically invalidate and supersede any and all previous issues. **A limited warranty applies to ITT Cannon products. Except for obligations assumed by ITT Cannon under this warranty, ITT Cannon shall not be liable for any loss, damage, cost of repairs, incidental or consequential damages of any kind, whether or not based on express or implied warranty, contract, negligence or strict liability arising in connection with the design, manufacture, sale, use or repair of the products.** Product availability, prices and delivery dates are exclusively subject to our respective order confirmation form; the same applies to orders based on development samples delivered. This catalog is not be construed as an offer. It is intended merely as an invitation to make an offer. By this publication, ITT Cannon does not assume responsibility or any liability for any patent infringements or other rights of third parties which may result from its use. Reprinting this catalog is generally permitted, indicating the source. However, ITT Cannon's prior consent must be obtained in all cases.

Cannon is a trademark of ITT Industries, Inc