

10 9 8 7 6 5 4 3 2 1

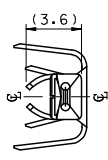

- NOTES.
1. MATERIAL : ⓄBRASS, PRE-TIN PLATED
 2. FINISH : 0.8~1.8μm,Tin(Sn) plating overall
0.3~0.8μm,Copper(Cu) plating
 3. PRODUCT SPECIFICATION : PS-35150-001, PS-35180-002
PS-35180-003, PS-35182-003, PS-35524-001
 4. CRIMPING SPECIFICAITON : CS-35745-001
 5. RECOMMENDED LENGTH OF WIRE STRIP IS 4.0~4.8mm
 6. APPLICABLE WIRE SIZE : AWG #20+#20
AWG #18+#18

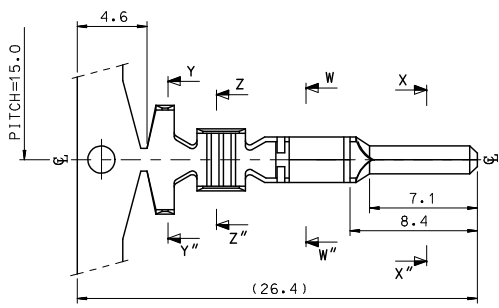
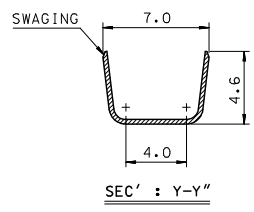
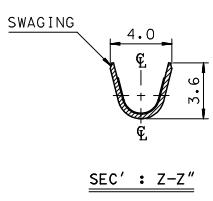
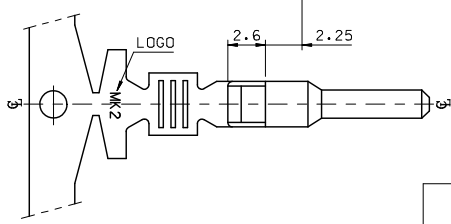
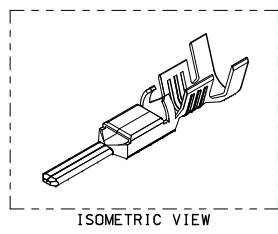
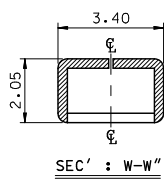
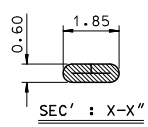
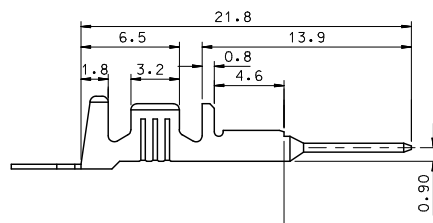

REVISED EC NO: KOR2009-0151 DRAWN: JHPARK01 2009/05/18 CHKD: W. YANG 2009/06/18 APPR: TUNSTIKKIM 2009/07/01	QUALITY SYMBOLS ▽=0 ▽=0	GENERAL TOLERANCES (UNLESS SPECIFIED)		DIMENSION STYLE MM ONLY		SCALE 4:1	DESIGN UNITS METRIC	THIRD ANGLE PROJECTION			
		4 PLACES ± --- ± ---	mm INCH	DRAWN BY JS. KANG	DATE 1998/01/19	TITLE .070 MALE TERMINAL-B (LARGE)					
		3 PLACES ± --- ± ---		CHECKED BY BK. CHOI	DATE 1998/01/19	MOLEX INCORPORATED					
		2 PLACES ± 0.2 ± --- 1 PLACE ± 0.3 ± --- ANGULAR ± 1°		APPROVED BY CW. LEE	DATE 1998/01/19	MATERIAL NO. 357470310	DOCUMENT NO. SD-35747-002	SHEET NO. 1 OF 01			
DRAFT WHERE APPLICABLE MUST REMAIN WITHIN DIMENSIONS		SIZE A3		THIS DRAWING CONTAINS INFORMATION THAT IS PROPRIETARY TO MOLEX INCORPORATED AND SHOULD NOT BE USED WITHOUT WRITTEN PERMISSION							

ib_frame_A3_P_ME_T
Rev. E 2006/04/15

9 8 7 6 5 4 3 2 1