

LOC	DIST	REVISIONS				
P	LTR	DESCRIPTION	DATE	DWN	APVD	
E	B	BA	NEW RELEASE	20-Sep-08	SM	St.P

FOR FURTHER INFORMATION SEE DATA SHEET FOR
CFR SERIES-CARBON FILM FIXED RESISTORS

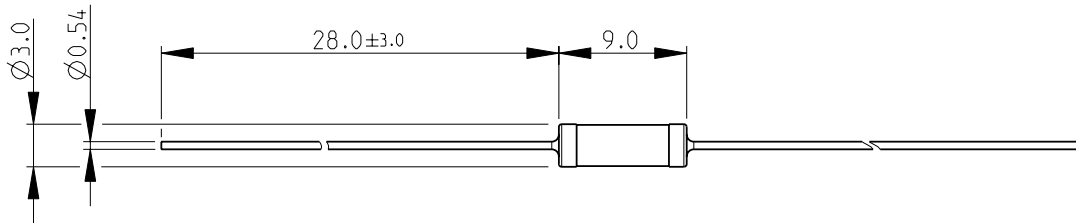

RoHS Compliant

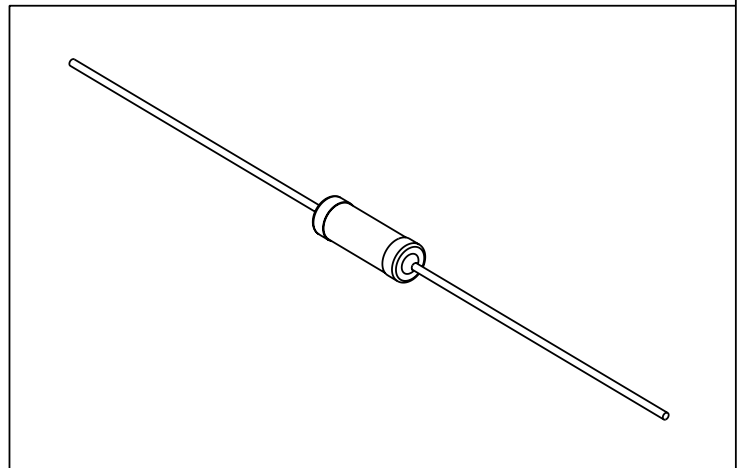

2008

RELEASED FOR PUBLICATION

THIS DRAWING IS UNPUBLISHED.

© COPYRIGHT 2008 BY TYCO ELECTRONICS CORPORATION. ALL RIGHTS RESERVED.

DIMENSIONS: mm	DWN	SUBHASH.M	20-Sep-08	MATERIAL	-	FINISH	-
	CHK	PRAKASH.S	20-Sep-08	Tyco Electronics Corporation Dorcan, Swindon, SN3 5HH			
TOLERANCES UNLESS OTHERWISE SPECIFIED:	APVD	STEPHEN.P	20-Sep-08				
0 PLC ± 0.2	PRODUCT SPEC	-	NAME	CARBON FILM FIXED RESISTORS SERIES CFR50			
1 PLC ± 0.1	APPLICATION SPEC	-	SIZE	CAGE CODE	DRAWING NO	RESTRICTED TO	
2 PLC $\pm -$	WEIGHT	-	A 4	00779	© = 1623933	-	
3 PLC $\pm -$	CUSTOMER DRAWING			SCALE	2:1	SHEET	1 OF 1
4 PLC $\pm -$						REV	BA
ANGLES $\pm 5^\circ$							