

Metal (Oxide) Film Resistors

Type: **ERG(X)S (Small size)**
(0.5 W, 1 W, 2 W, 3 W, 5 W)
ERG(X)F (Anti-heat conducting for PCB)
(1 W, 2 W, 3 W, 5 W)

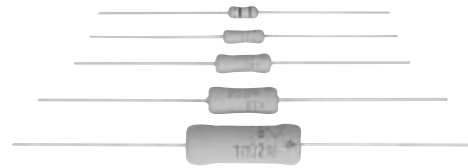

■ Features

- Miniaturized
50 % smaller compared to existing models
- Non-flammable
- High Reliability
- Automatic Insertion
- Reference Standards
IEC 60115-2, IEC 60115-4, JIS C 5201-4, EIAJ RC-2138

■ Explanation of Part Numbers

Ex.1 : ERX type

| | | | | | | | | | | | | |
|----------|----------|----------|---|----------|----------|----------|----------|----------|----------|----------|----------|----------|
| 1 | 2 | 3 | 4 | 5 | 6 | 7 | 8 | 9 | 10 | 11 | 12 | |
| E | R | X | | 2 | S | Z | J | W | 1 | R | 0 | E |

Product Code
ERX Metal Film Resistors

Power Rating at 70 °C

| | |
|----|-------|
| 12 | 0.5 W |
| 1 | 1 W |
| 2 | 2 W |
| 3 | 3 W |
| 5 | 5 W |

Style - Specification

| | |
|---|---|
| S | Small size 0.5 W to 5 W |
| F | Small size Anti-heat conducting type (Fe lead wire) 1 W to 5 W |

Resistance Tolerance

| | |
|---|------|
| J | ±5 % |
| G | ±2 % |

Resistance Value

The first two digits are significant figures of resistance and the third one denotes number of zeros following.
Decimal point is expressed by
(Ex.) 1R0 : 1.0 Ω

"Z" is added according to resistance.

| Type | Resistance Tolerance | Resistance Value Range (Ω) | |
|--------|----------------------|----------------------------|-------------|
| | | ERX□□SZ | ERX□□S |
| ERX12S | ±5 % | 0.10 to 0.18 | 0.20 to 9.1 |
| | ±2 % | 0.10 to 0.91 | 1.0 to 9.1 |
| ERX1S | ±5 % | 0.10 to 0.18 | 0.20 to 9.1 |
| ERX1F | ±2 % | 0.10 to 0.91 | 1.0 to 9.1 |
| ERX2S | ±5 % | 0.10 to 0.20 | 0.22 to 9.1 |
| ERX2F | ±2 % | 0.10 to 0.91 | 1.0 to 9.1 |
| ERX3S | ±5 % | 0.10 to 0.20 | 0.22 to 9.1 |
| ERX3F | ±2 % | 0.10 to 0.91 | 1.0 to 9.1 |
| ERX5S | ±5 % | — | 0.33 to 9.1 |
| ERX5F | ±2 % | — | 1.0 to 9.1 |

The matrix of forming and packaging is as shown in the table below.

| Code | Forming / Packaging | Forming & Taping matrix | | | | | | | | | |
|-------|-----------------------------------|-------------------------|----|----|----|----|----|----|----|----|--|
| | | 12S | 1S | 2S | 3S | 5S | 1F | 2F | 3F | 5F | |
| □...□ | Straight lead wire type | ○ | ○ | ○ | ○ | ○ | ○ | ○ | ○ | ○ | |
| □...P | Cut & Forming type | ○ | ○ | ○ | ○ | ○ | | | | | |
| □...V | Axial taping type (Straight lead) | ○ | ○ | ○ | ○ | | ○ | ○ | ○ | | |
| U...V | Axial taping type (Stand off) | | ○ | ○ | ○ | | | | | | |
| □...E | Radial taping type (E type) | ○ | ○ | ○ | | | | | | | |
| W...E | Radial taping type (WE type) | ○ | ○ | ○ | ○ | | | | | | |
| □...H | Cut & Forming type | | | | | | ○ | ○ | ○ | ○ | |
| S...E | Radial taping type (SE type) | | | | | | ○ | ○ | ○ | | |

The above example 1 shows a small metal film resistor, 2 W power rating, resistance value of 1.0 Ω, tolerance ±5 %, and package of radial taping.

Ex.2 : ERG type

| | | | | | | | | | | | |
|----------|----------|----------|---|----------|----------|----------|----------|----------|----------|----------|----------|
| 1 | 2 | 3 | 4 | 5 | 6 | 7 | 8 | 9 | 10 | 11 | 12 |
| E | R | G | | 2 | S | J | W | 1 | 0 | 3 | E |

Product Code
ERG Metal Oxide Film Resistors

Power Rating at 70 °C

| | |
|----|-------|
| 12 | 0.5 W |
| 1 | 1 W |
| 2 | 2 W |
| 3 | 3 W |
| 5 | 5 W |

Style - Specification

| | |
|---|---|
| S | Small size 0.5 W to 5 W |
| F | Small size Anti-heat conducting type (Fe lead wire) 1 W to 5 W |

Resistance Tolerance

| | |
|---|------|
| J | ±5 % |
| G | ±2 % |

Resistance Value

The first two digits are significant figures of resistance and the third one denotes number of zeros following.
Decimal point is expressed by
(Ex.) 103 : 10 kΩ

The matrix of forming and packaging is as shown in the table below.

| Code | Forming / Packaging | Forming & Taping matrix | | | | | | | | | |
|-------|-----------------------------------|-------------------------|----|----|----|----|----|----|----|----|--|
| | | 12S | 1S | 2S | 3S | 5S | 1F | 2F | 3F | 5F | |
| □...□ | Straight lead wire type | ○ | ○ | ○ | ○ | ○ | ○ | ○ | ○ | ○ | |
| □...P | Cut & Forming type | ○ | ○ | ○ | ○ | ○ | | | | | |
| □...V | Axial taping type (Straight lead) | ○ | ○ | ○ | ○ | | ○ | ○ | ○ | | |
| U...V | Axial taping type (Stand off) | | ○ | ○ | ○ | | | | | | |
| □...E | Radial taping type (E type) | ○ | ○ | ○ | | | | | | | |
| W...E | Radial taping type (WE type) | ○ | ○ | ○ | ○ | | | | | | |
| □...H | Cut & Forming type | | | | | | ○ | ○ | ○ | ○ | |
| S...E | Radial taping type (SE type) | | | | | | ○ | ○ | ○ | | |

The above example 2 shows a small metal oxide film resistor, 2 W power rating, resistance value of 10 kΩ, tolerance ±5 %, and package of radial taping.

Design and specifications are each subject to change without notice. Ask factory for the current technical specifications before purchase and/or use.
Should a safety concern arise regarding this product, please be sure to contact us immediately.

Construction

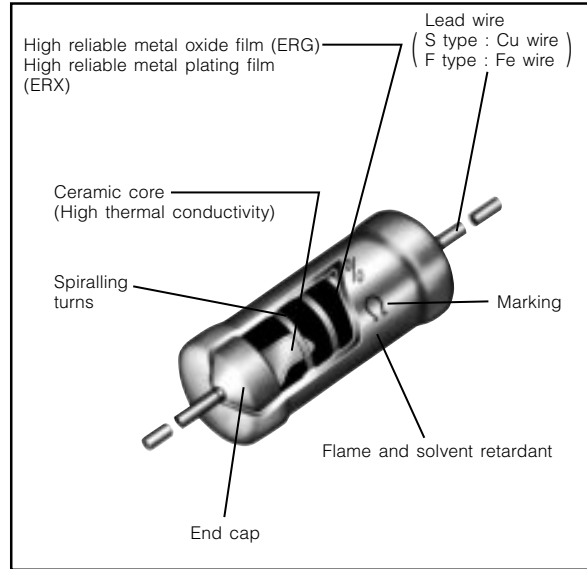

Dimensions in mm (not to scale)

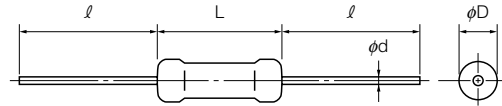

| Type | Dimensions (mm) | | | | Mass (Weight) [g/pc.] |
|-----------|---|-------------------------------------|----------------------|-----------------------|-----------------------|
| | L | φD | ℓ | φd | |
| ERG(X)12S | 6.35 ^{+0.65} _{-0.35} | 2.3 ^{+0.5} _{-0.3} | 30.0 ^{±3.0} | 0.65 ^{±0.05} | 0.26 |
| ERG(X)1S | 9.00 ^{+1.50} _{-1.00} | 2.8 ^{±0.5} | 30.0 ^{±3.0} | 0.65 ^{±0.05} | 0.33 |
| ERG(X)1F | | | | 0.80 ^{±0.05} | |
| ERG(X)2S | 12.00 ^{+1.50} _{-1.00} | 4.0 ^{±1.0} | 30.0 ^{±3.0} | 0.80 ^{±0.05} | 0.66 |
| ERG(X)2F | | | | 0.80 ^{±0.05} | |
| ERG(X)3S | 15.00 ^{+1.50} | 5.5 ^{±1.0} | 38.0 ^{±3.0} | 0.80 ^{±0.05} | 1.47 |
| ERG(X)3F | | | | 0.80 ^{±0.05} | |
| ERG(X)5S | 24.00 ^{±1.50} | 8.0 ^{±1.0} | 38.0 ^{±3.0} | 0.80 ^{±0.05} | 3.54 |
| ERG(X)5F | | | | 0.80 ^{±0.05} | |

Ratings

| Type | Power Rating at 70 °C (W) | Limiting Element Voltage ⁽¹⁾ (V) | Maximum Overload Voltage ⁽²⁾ (V) | Maximum Intermittent Overload Voltage ⁽³⁾ (V) | Dielectric With-standing Voltage (VAC) | Res. Tol. (%) ⁽⁴⁾ | Resistance Range (Ω) ⁽⁵⁾ | | T.C.R. (×10 ⁻⁶ /°C) | Standard Resistance Value |
|----------------------|---------------------------|---|---|--|--|------------------------------|-------------------------------------|-------|--------------------------------|---------------------------|
| | | | | | | | min. ⁽⁶⁾ | max. | | |
| ERG(X)12S | 0.5 | 300 | 600 | 600 | 350 | G (±2) | 1 | 22 k | ±350 | E24 |
| | | | | | | | 0.2 | 47 k | | |
| ERG(X)1S ERG(X)1F | 1 | 350 | 600 | 600 | 350 | G (±2) | 1 | 68 k | ±350 | E24 |
| | | | | | | | 0.2 | 100 k | | |
| ERG(X)2S ERG(X)2F | 2 | 350 | 700 | 1000 | 600 | G (±2) | 1 | 100 k | ±350 | E24 |
| | | | | | | | 0.22 | 100 k | | |
| ERG(X)3S ERG(X)3F | 3 | 350 | 700 | 1000 | 1000 | G (±2) | 1 | 100 k | ±300 | E24 |
| | | | | | | | 0.22 | 100 k | | |
| ERG(X)5S ERG(X)5F | 5 | 500 | 1000 | 1500 | 1000 | G (±2) | 1 | 100 k | ±200 | E24 |
| | | | | | | | 0.33 | 100 k | | |

- (1) Rated Continuous Working Voltage (RCWV) shall be determined from RCWV=√Power Rating×Resistance Value or Limiting Element Voltage listed above whichever less.
- (2) Overload (Short-time Overload) Test Voltage (SOTV) shall be determined from SOTV=2.5×Power Rating or max. Overload Voltage listed above whichever less.
- (3) Intermittent Overload Test Voltage (IOTV) shall be determined from IOTV=4.0×Power Rating or max. Intermittent Overload Voltage listed above whichever less.

- (4) Resistance tolerance is of use besides range listed, please inquire.
- (5) Resistance Range Type ERG : ≥10 Ω
Type ERX : ≤9.1 Ω
- (6) As for the low resistance value range, "Z" is given to the part number. (Refer to the explanation of part numbers.)

* Z type is non standard resistance values.

| Code | Type | Res. Tol. | Res. Value Range | Code | Type | Res. Tol. | Res. Value Range |
|------|------|-----------|------------------|------|------|-----------|------------------|
| Z | 12S | ±2 % | 0.1 to 0.91 Ω | Z | 2S | ±2 % | 0.1 to 0.91 Ω |
| | | ±5 % | 0.1 to 0.18 Ω | | 2F | ±5 % | 0.1 to 0.2 Ω |
| | 1S | ±2 % | 0.1 to 0.91 Ω | | 3S | ±2 % | 0.1 to 0.91 Ω |
| | | ±5 % | 0.1 to 0.18 Ω | | 3F | ±5 % | 0.1 to 0.2 Ω |

Power Derating Curve

For resistors operated in ambient temperatures above 70 °C, power rating shall be derated in accordance with the figure on the right.

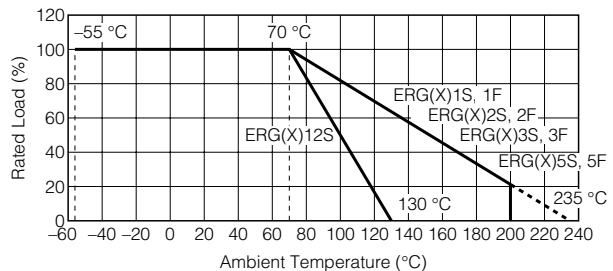

Design and specifications are each subject to change without notice. Ask factory for the current technical specifications before purchase and/or use. Should a safety concern arise regarding this product, please be sure to contact us immediately.

■ Taped & Box:

ERG(X)□□S□□□□□V

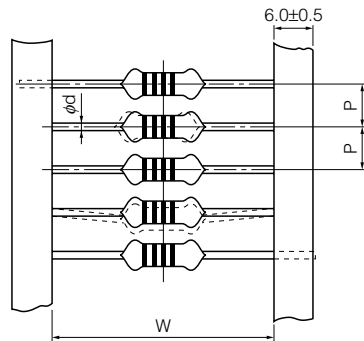

■ Stand-off Taped & Box:

ERG(X)□□S□U□□□□V

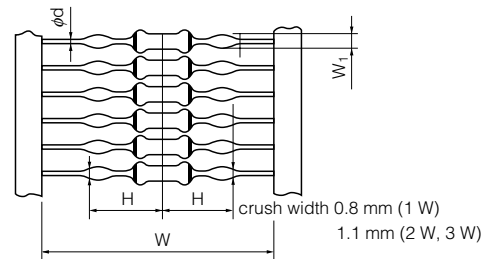

| Part Number | Standard Quantity (pcs./box) | Taping (mm) | | | | | | Box (mm) | | |
|------------------|------------------------------|----------------------|-------------------|----------------------|------------------------|------------------------|-----------------------|----------|-----|-----|
| | | P | 50×P | W | H | W ₁ | φd | a | b | c |
| ERG(X)12S□□□□□V | 2000 | 5.0 ^{+0.3} | 250 ^{±2} | 52.0 ^{+1.5} | — | — | 0.65 ^{+0.05} | 85 | 80 | 255 |
| ERG(X) 1S□□□□□V | 2000 | 5.0 ^{+0.3} | 250 ^{±2} | 52.0 ^{+1.5} | — | — | 0.65 ^{+0.05} | 85 | 80 | 255 |
| ERG(X) 1S□U□□□□V | | | | | 12.0 ^{+0-2.0} | 1.2 ^{+0.15-0} | | | | |
| ERG(X) 2S□□□□□V | 1000 | 5.0 ^{+0.3} | 250 ^{±2} | 52.0 ^{+1.5} | — | — | 0.80 ^{+0.05} | 85 | 80 | 255 |
| ERG(X) 2S□U□□□□V | | | | | 15.5 ^{+0-2.0} | 1.4 ^{+0.15-0} | | | | |
| ERG(X) 3S□□□□□V | 1000 | 10.0 ^{+0.5} | 500 ^{±2} | 74.0 ^{±2.0} | — | — | 0.80 ^{+0.05} | 105 | 100 | 325 |
| ERG(X) 3S□U□□□□V | | | | | 23.0 ^{+0-2.0} | 1.4 ^{+0.15-0} | | | | |

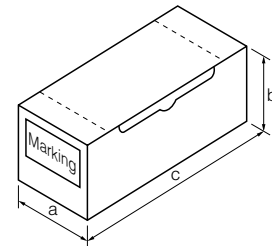

■ Cut & Formed Type

ERG(X)□□S□□□□□P

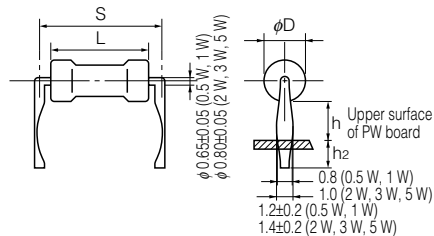

| Part Number | Standard Quantity (pcs./box) | Dimensions (mm) | | | | |
|-----------------|------------------------------|-----------------------------|-------------------------|----------------------|---------------------|---------------------|
| | | L | φD | S | h | h ₂ |
| ERG(X)12S□□□□□P | 2000 | 6.35 ^{+0.65-0.35} | 2.3 ^{+0.5-0.3} | 10.0 ^{+1.5} | 4.0 ^{+1.5} | 4.0 ^{+1.5} |
| ERG(X)1S□□□□□P | 2000 | 9.00 ^{+1.50-1.00} | 2.8 ^{+0.5} | 12.5 ^{+1.5} | 4.0 ^{+1.5} | 4.0 ^{+1.5} |
| ERG(X)2S□□□□□P | 1000 | 12.00 ^{+1.50-1.00} | 4.0 ^{+1.0} | 15.0 ^{+1.5} | 6.0 ^{+1.5} | 4.0 ^{+1.5} |
| ERG(X)3S□□□□□P | 1000 | 15.00 ^{+1.50} | 5.5 ^{+1.0} | 20.0 ^{±2.0} | 6.5 ^{+1.5} | 4.0 ^{+1.5} |
| ERG(X)5S□□□□□P | 500 | 24.00 ^{+1.50} | 8.0 ^{+1.0} | 30.0 ^{±2.0} | 7.5 ^{+1.5} | 4.0 ^{+1.5} |

ERG(X)□F□□□□□H

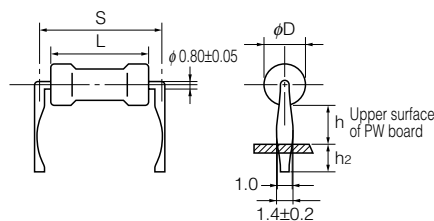

| Part Number | Standard Quantity (pcs./box) | Dimensions (mm) | | | | |
|----------------|------------------------------|--------------------------|---------------------|----------------------|------------------|---------------------|
| | | L | φD | S | h | h ₂ |
| ERG(X)1F□□□□□H | 1000 | 9.0 ^{+1.5-1.0} | 2.8 ^{+0.5} | 12.5 ^{+1.5} | 8 ^{±2} | 4.0 ^{+1.5} |
| ERG(X)2F□□□□□H | 1000 | 12.0 ^{+1.5-1.0} | 4.0 ^{+1.0} | 15.0 ^{+1.5} | 6 ^{±2} | 5.0 ^{+1.5} |
| ERG(X)3F□□□□□H | 1000 | 15.0 ^{+1.5} | 5.5 ^{+1.0} | 20.0 ^{±2.0} | 10 ^{±2} | 5.0 ^{+1.5} |
| ERG(X)5F□□□□□H | 500 | 24.0 ^{+1.5} | 8.0 ^{+1.0} | 30.0 ^{±2.0} | 10 ^{±2} | 5.0 ^{+1.5} |

Design and specifications are each subject to change without notice. Ask factory for the current technical specifications before purchase and/or use. Should a safety concern arise regarding this product, please be sure to contact us immediately.

00 Sep. 2010

■ For Panasert Automatic Insertion Machine Radial Tape & Box

Type ERG(X)□□S□□□□E (12S, 1S, 2S)

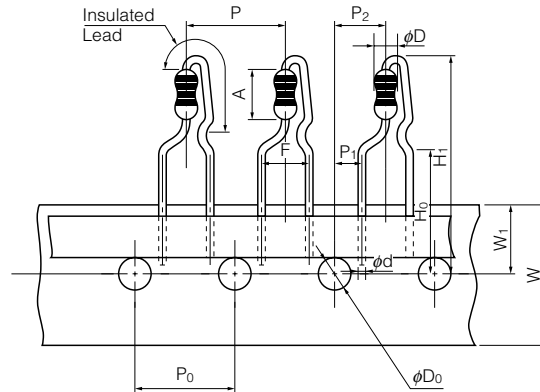

| Dimensions (mm) | | Dimensions (mm) | | Dimensions (mm) | | Dimensions (mm) | | Dimensions (mm) | | | | |
|-----------------|-----------|-----------------|----------|--------------------|----------|-----------------|-------|-----------------|--|-------|-----|-------------------------------------|
| P | 12.7±1.0 | W | 18.0±0.5 | H ₁ | 12S | 32 max. | A | 12S | 6.35 ^{+0.65} _{-0.35} | phi D | 12S | 2.3 ^{+0.5} _{-0.3} |
| P ₀ | 12.7±0.3 | W ₁ | 9.0±0.5 | | 1S | 32 max. | | 1S | 9.0 ^{+1.5} _{-1.0} | | 1S | 2.8±0.5 |
| P ₁ | 3.85±0.70 | | | | 2S | 38 max. | | 2S | 12.0 ^{+1.5} _{-1.0} | | 2S | 4.0±1.0 |
| P ₂ | 6.35±1.00 | | | H ₀ | 16.0±0.5 | | phi d | 0.65±0.05 | | | | |
| F | 5.0±0.8 | | | phi D ₀ | 4.0±0.2 | | | | | | | |

● Radial Tape Package Specifications



| Part Number | Dimensions (mm) | | | Standard Quantity (pcs./box) |
|----------------|-----------------|-----|-----|------------------------------|
| | a | b | c | |
| ERG(X)12S□□□□E | 46 | 130 | 335 | 2000 |
| ERG(X) 1S□□□□E | 46 | 130 | 335 | 2000 |
| ERG(X) 2S□□□□E | 49 | 100 | 335 | 1000 |

■ For Panasert Automatic Insertion Machine Radial Taped & Box

Type ERG(X)□□S□W□□□E (12S, 1S, 2S, 3S)

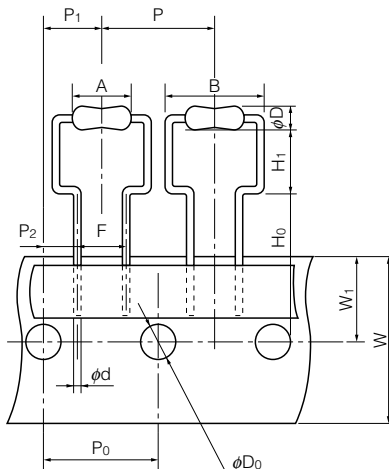

| Dimensions (mm) | | Dimensions (mm) | | | |
|-----------------|-----------------|-------------------------------------|--------------------|-----------------|--|
| P | 12S | 12.7±1.0 | phi D ₀ | 12S, 1S, 2S, 3S | 4.0±0.2 |
| | 1S, 2S, 3S | 30.0±1.0 | | 12S | 6.35 ^{+0.65} _{-0.35} |
| P ₀ | 12S | 12.7±0.3 | A | 1S | 9.0 ^{+1.5} _{-1.0} |
| | 1S, 2S, 3S | 15.0±0.3 | | 2S | 12.0 ^{+1.5} _{-1.0} |
| | | | | 3S | 15.0±1.5 |
| P ₁ | 12S | 6.35±1.00 | B | 12S | 11.2 max. |
| | 1S, 2S, 3S | 7.5±1.0 | | 1S | 14.0 max. |
| P ₂ | 12S | 3.85±0.70 | phi D | 2S | 17.0 max. |
| | 1S, 2S, 3S | 3.75±0.50 | | 3S | 21.0 max. |
| F | 12S | 5.0±0.5 | | phi D | 12S |
| | 1S, 2S, 3S | 7.5±0.8 | 1S | | 2.8±0.5 |
| W | 12S, 1S, 2S, 3S | 18.0±0.5 | phi D | 2S | 4.0±1.0 |
| W ₁ | 12S, 1S, 2S, 3S | 9.0±0.5 | | 3S | 5.5±1.0 |
| H ₀ | 12S | 16.0±0.5 | phi d | 12S | phi 0.65±0.05 |
| | 1S, 2S | 18.0±1.0 | | 1S, 2S, 3S | phi 0.80±0.05 |
| | 3S | 19.0±1.0 | | | |
| H ₁ | 12S | 6.5 ^{+0.6} _{-0.6} | | | |
| | 1S, 2S | 6.5 ^{+1.0} _{-1.0} | | | |
| | 3S | 8.0 ^{+1.0} _{-1.0} | | | |

Design and specifications are each subject to change without notice. Ask factory for the current technical specifications before purchase and/or use. Should a safety concern arise regarding this product, please be sure to contact us immediately.

00 Sep. 2010

■ For Panasert Automatic Insertion Machine Radial Taped & Box

Type ERG(X)□F□S□□□E (1F, 2F, 3F)

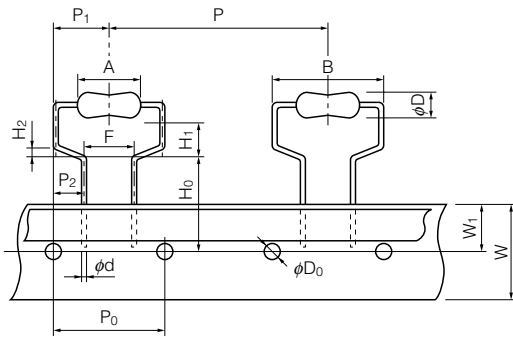

| Dimensions (mm) | | Dimensions (mm) | |
|-----------------|--------------------------------------|-----------------|---|
| P | 30.0±1.0 | H ₂ | 1.0±0.3 |
| P ₀ | 15.0±0.3 | φD ₀ | 4.0±0.2 |
| P ₁ | 7.5±1.0 | A | 1F 9.0 ^{+1.5} _{-1.0} |
| P ₂ | 3.75±0.50 | | 2F 12.0 ^{+1.5} _{-1.0} |
| F | 7.5±0.8 | | 3F 15.0±1.5 |
| W | 18.0±0.5 | B | 1F 14 max. |
| W ₁ | 9.0±0.5 | | 2F 17 max. |
| H ₀ | 16.0 ^{+1.0} ₋₀ | | 3F 21 max. |
| H ₁ | 1F 7.0 ^{+1.0} ₋₀ | φD | 1F 2.8±0.5 |
| | 2F 8.0 ^{+1.0} ₋₀ | | 2F 4.0±1.0 |
| | 3F 9.0 ^{+1.0} ₋₀ | | 3F 5.5±1.0 |
| | | φd | 0.80±0.05 |

● Radial Tape Package Specifications

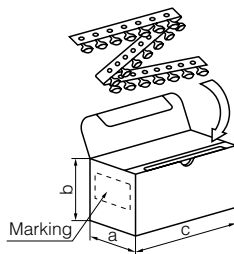

| Type | Dimensions (mm) | | | Standard Quantity (pcs./box) |
|-----------------|-----------------|-----|-----|------------------------------|
| | a | b | c | |
| ERG(X)12S□W□□□E | 46 | 145 | 325 | 2000 |
| ERG(X) 1S□W□□□E | 49 | 150 | 317 | 1000 |
| ERG(X) 1F□S□□□E | | | | |
| ERG(X) 2S□W□□□E | 49 | 150 | 317 | 500 |
| ERG(X) 2F□S□□□E | | | | |
| ERG(X) 3F□S□□□E | 49 | 190 | 315 | 500 |

Hot-spot Temperature (for Reference)

The temperature of the resistor body increases with the curve below. A touching vinyl wire may cause damages to resistor element. Do not place vinyl wires around resistors and be sure to consider where the resistors will be placed.

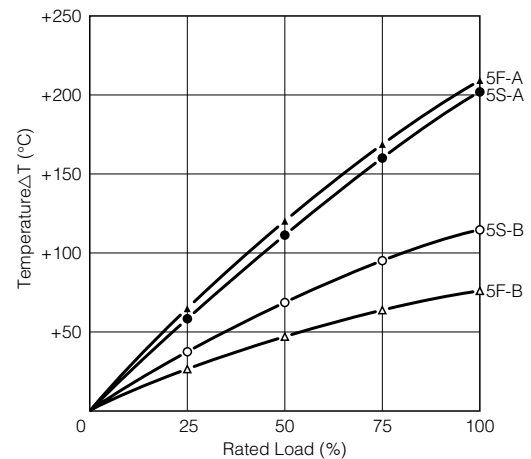
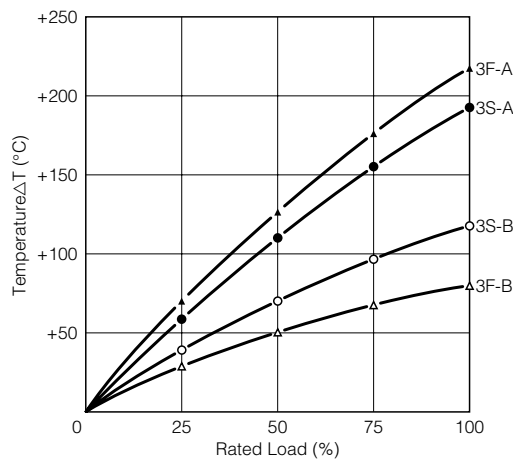
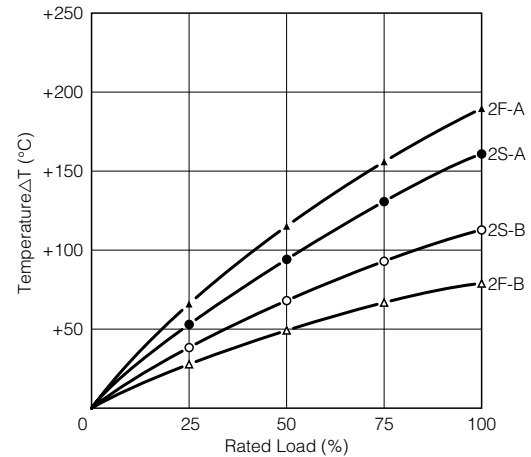
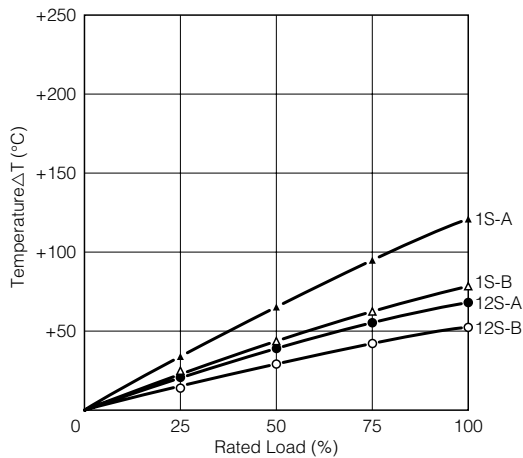

⚠ Safety Precautions

The following are precautions for individual products. Please also refer to the common precautions shown on page 4 of this catalog.

1. Transient voltage

If there is a possibility that the transient phenomenon (significantly high voltage applied in a short time) may occur or that a high voltage pulse may be applied, make sure to evaluate and check the characteristics of Metal(Oxide) Film Resistors (hereafter called the resistors) mounted on your product rather than only depending on the calculated power limit or steady-state conditions to complete the design or decide to use the resistors.

2. The resistors are covered with a special coating. Do not apply shock or vibration to them, or pinch them with long-nose pliers. Otherwise, the resistors may be damaged.
3. Do not apply excessive tension to the lead-connected sections. When bending the lead wire, do not apply excessive stress to the resistors and provide the wire with a natural curvature.
4. Do not brush the resistors during or after the cleaning process, which may be conducted after soldering. Otherwise, the coating film may be damaged.

(Data for Reference)

■ Pulse Characteristics (Usual)

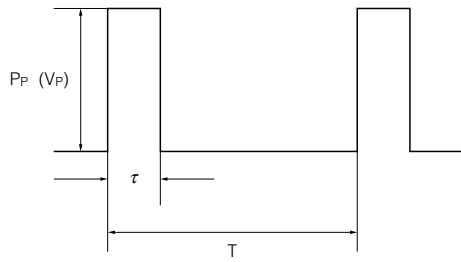

P_P : Pulse limit power (W)
 V_P : Pulse limit voltage (V)
 τ : Pulse continuous time (s)
 T : Period (s)
 V_R : Rated voltage (V)
 P : Rated power (W)
 R : Resistance value (Ω)
 $V_{P\ max.}$: Max. pulse limit voltage (V)

Withstand pulse limit power is calculated by the next method.

$$P_P = K \cdot P \cdot T / \tau$$

$$V_P = \sqrt{K \cdot P \cdot R \cdot T / \tau}$$

Reference to the right about a fixed number of $V_{P\ max.}$.

- $T > 1(s) \rightarrow T = 1(s)$
- $T / \tau > 100 \rightarrow T / \tau = 100$
- $P_P < P \rightarrow P$ stands for P_P
($V_P < V_R \rightarrow V_R$ stands for V_P)
- Added voltage $\leq V_{P\ max.}$
- P_P or V_P is referent value

Conditions: Pulse added time = 1000 h
 Resistance change = $\pm 5\%$
 Room temperature

| Type | K | $V_{P\ max.}$ (V) |
|------------|-----|-------------------|
| ERG(X) 12S | 0.5 | 600 |
| ERG(X) 1S | 0.5 | 600 |
| ERG(X) 2S | 0.5 | 700 |
| ERG(X) 3S | 0.5 | 700 |
| ERG(X) 5S | 0.5 | 1000 |