

LOC	DIST	REVISIONS					
E	B	P	LTR	DESCRIPTION	DATE	DWN	APVD
			BA	NEW RELEASE			05MAY2010

FOR FURTHER INFORMATION SEE DATA SHEET FOR
RP73 SERIES-SMD HIGH POWER PRECISION RESISTORS

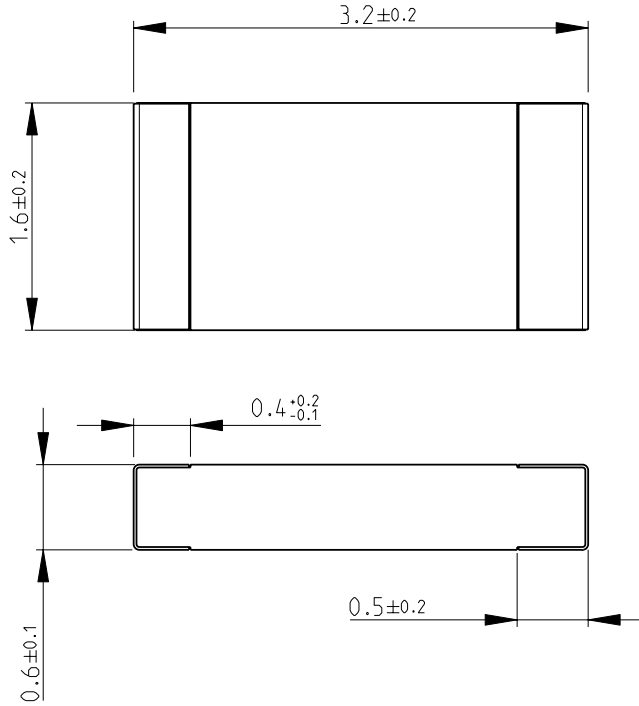

RoHS Compliant

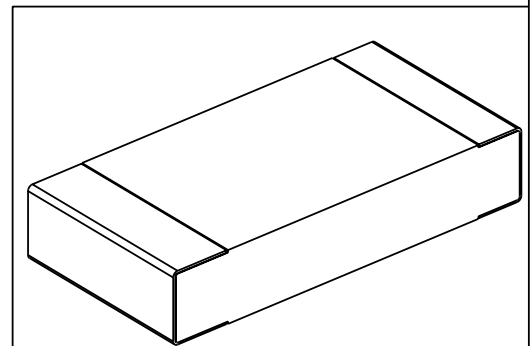

2008

RELEASED FOR PUBLICATION

THIS DRAWING IS UNPUBLISHED.

© COPYRIGHT 2008 BY TYCO ELECTRONICS CORPORATION. ALL RIGHTS RESERVED.

DIMENSIONS: mm	DWN	PARUSURAM.T	05MAY2010	MATERIAL	-	FINISH	-
	CHK	SUBHASH.M	05MAY2010	Tyco Electronics Corporation Dorcan, Swindon, SN3 5HH			
TOLERANCES UNLESS OTHERWISE SPECIFIED:	APVD	STEPHEN.P	05MAY2010				
0 PLC ±0.2	PRODUCT SPEC	-	NAME	SMD HIGH POWER PRECISION RESISTORS SERIES RP73 - 2B			
1 PLC ±0.1	APPLICATION SPEC	-	SIZE	CAGE CODE	DRAWING NO	RESTRICTED TO	
2 PLC ±-	WEIGHT	-	A 4	00779	© = 1879263	-	
3 PLC ±-			CUSTOMER DRAWING				
4 PLC ±-			SCALE	20:1	SHEET	1 OF 1	REV
ANGLES ±5°							BA