

LOC	DIST	REVISIONS					
E	B	P	LTR	DESCRIPTION	DATE	DWN	APVD
			BA	NEW RELEASE	25-AUG-09	MRS	St.P

FOR FURTHER INFORMATION SEE DATA SHEET FOR
CRG SERIES-THICK FILM CHIP RESISTORS

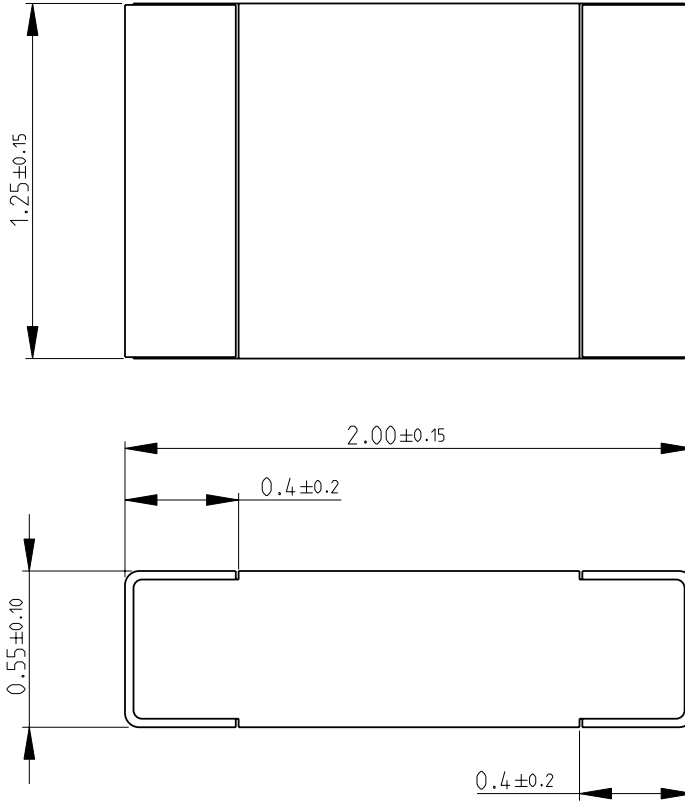

RoHS Compliant

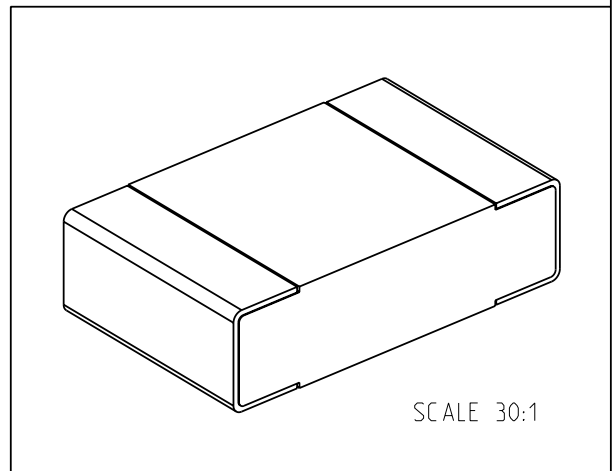

2009

RELEASED FOR PUBLICATION

THIS DRAWING IS UNPUBLISHED.

© COPYRIGHT 2009 BY TYCO ELECTRONICS CORPORATION. ALL RIGHTS RESERVED.

DIMENSIONS: mm	DWN MAHARUDRA	25-AUG-09	MATERIAL	-	FINISH	-
	CHK ALLAN.P	25-AUG-09	Tyco Electronics Corporation Dorcan, Swindon, SN3 5HH			
TOLERANCES UNLESS OTHERWISE SPECIFIED:	APVD STEPHEN.P	25-AUG-09				
0 PLC ±0.5	PRODUCT SPEC		NAME THICK FILM CHIP RESISTORS			
1 PLC ±0.2	-		SERIES CRG 0805			
2 PLC ±0.1	APPLICATION SPEC		SIZE	CAGE CODE	DRAWING NO	RESTRICTED TO
3 PLC ±-	-		A 4	00779	©= 1623353	-
4 PLC ±-	WEIGHT		CUSTOMER DRAWING			
ANGLES ±5°	-		SCALE	40:1	SHEET	1 OF 1
	-		REV BA			