

NCV8664

Very Low I_q Low Dropout Linear Regulator

The NCV8664 is a precision 3.3 V and 5.0 V fixed output, low dropout integrated voltage regulator with an output current capability of 150 mA. Careful management of light load current consumption, combined with a low leakage process, achieve a typical quiescent current of 22 μ A.

NCV8664 is pin and functionally compatible with NCV4264 and NCV4264-2, and it could replace these parts when very low quiescent current is required.

The output voltage is accurate within $\pm 2.0\%$, and maximum dropout voltage is 600 mV at full rated load current.

It is internally protected against input supply reversal, output overcurrent faults, and excess die temperature. No external components are required to enable these features.

Features

- 3.3 V, 5.0 V Fixed Output
- $\pm 2.0\%$ Output Accuracy, Over Full Temperature Range
- 30 μ A Maximum Quiescent Current at $I_{OUT} = 100 \mu$ A
- 600 mV Maximum Dropout Voltage at 150 mA Load Current
- Wide Input Voltage Operating Range of 4.5 V to 45 V
- Internal Fault Protection
 - ◆ -42 V Reverse Voltage
 - ◆ Short Circuit/Overcurrent
 - ◆ Thermal Overload
- NCV Prefix for Automotive and Other Applications Requiring Site and Control Changes
- AEC-Q100 Qualified
- EMC Compliant
- These are Pb-Free Devices



ON Semiconductor®

<http://onsemi.com>

MARKING DIAGRAMS

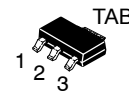

**SOT-223
ST SUFFIX
CASE 318E**

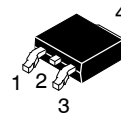
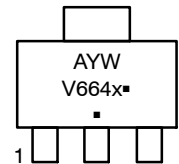

**DPAK
DT SUFFIX
CASE 369C**

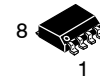
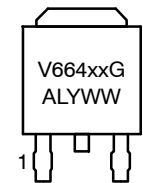

**SOIC-8 Fused
CASE 751**

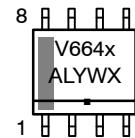

- xx = Voltage Rating DPAK
(50 = 5.0 V Version)
(33 = 3.3 V Version)
- x = Voltage Rating SOT223
(5 = 5.0 V Version)
(3 = 3.3 V Version)
- A = Assembly Location
- L = Wafer Lot
- Y = Year
- W, WW = Work Week
- or G = Pb-Free Package

(Note: Microdot may be in either location)

PIN CONNECTIONS

(SOT-223/DPAK)		(SOIC-8 Fused)	
PIN	FUNCTION	PIN	FUNCTION
1	V_{IN}	1	NC
2, TAB	GND	2,	V_{IN}
3	V_{OUT}	3	GND
		4.	V_{OUT}
		5-8.	NC

ORDERING INFORMATION

See detailed ordering and shipping information in the package dimensions section on page 11 of this data sheet.

NCV8664

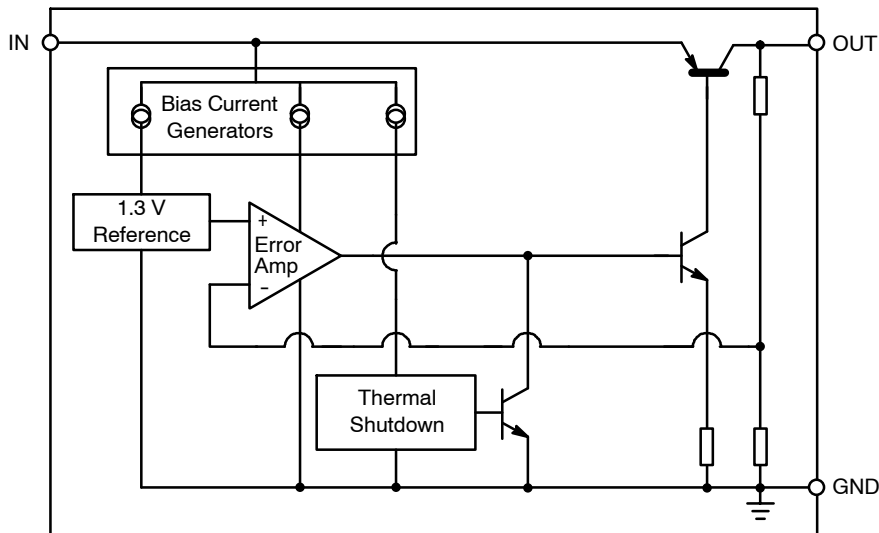

Figure 1. Block Diagram

PIN FUNCTION DESCRIPTION

Pin No.		Symbol	Function
DPAK/SOT-223	SOIC-8		
1	2	V_{IN}	Unregulated input voltage; 4.5 V to 45 V.
2	3	GND	Ground; substrate.
3	4	V_{OUT}	Regulated output voltage; collector of the internal PNP pass transistor.
TAB	-	GND	Ground; substrate and best thermal connection to the die.
-	1, 5-8	NC	No Connection.

OPERATING RANGE

Pin Symbol, Parameter	Symbol	Min	Max	Unit
V_{IN} , DC Input Operating Voltage	V_{IN}	4.5	+45	V
Junction Temperature Operating Range	T_J	-40	+150	°C

MAXIMUM RATINGS

Rating	Symbol	Min	Max	Unit
V_{IN} , DC Voltage	V_{IN}	-42	+45	V
V_{OUT} , DC Voltage	V_{OUT}	-0.3	+18	V
Storage Temperature	T_{stg}	-55	+150	°C
ESD Capability, Human Body Model (Note 1)	V_{ESDHB}	4000	-	V
ESD Capability, Machine Model (Note 1)	V_{ESDMIM}	200	-	V

Stresses exceeding Maximum Ratings may damage the device. Maximum Ratings are stress ratings only. Functional operation above the Recommended Operating Conditions is not implied. Extended exposure to stresses above the Recommended Operating Conditions may affect device reliability.

- This device series incorporates ESD protection and is tested by the following methods:
 ESD HBM tested per AEC-Q100-002 (EIA/JESD22-A 114C)
 ESD MM tested per AEC-Q100-003 (EIA/JESD22-A 115C)

THERMAL RESISTANCE

Parameter	Symbol	Condition	Min	Max	Unit
Junction-to-Ambient	DPAK		-	101 (Note 2)	°C/W
	SOT-223		-	99 (Note 2)	
	SOIC-8 Fused		-	145	
Junction-to-Case	DPAK		-	9.0	°C/W
	SOT-223		-	17	
	SOIC-8 Fused		-	-	

- 1 oz., 100 mm² copper area.

NCV8664

LEAD SOLDERING TEMPERATURE AND MSL

Rating	Symbol	Min	Max	Unit
Lead Temperature Soldering Reflow (SMD Styles Only), Lead Free (Note 3)	T_{sld}	-	265 pk	°C
Moisture Sensitivity Level	SOT223 DPAK SOIC-8 Fused	3 2 1	- - -	-

3. Lead Free, 60 sec – 150 sec above 217°C, 40 sec max at peak.

ELECTRICAL CHARACTERISTICS ($V_{IN} = 13.5\text{ V}$, $T_J = -40^\circ\text{C}$ to $+150^\circ\text{C}$, unless otherwise noted.)

Characteristic	Symbol	Test Conditions	Min	Typ	Max	Unit
Output Voltage 5.0 V Version	V_{OUT}	$0.1\text{ mA} \leq I_{OUT} \leq 150\text{ mA}$ (Note 4) $6.0\text{ V} \leq V_{IN} \leq 28\text{ V}$	4.900	5.000	5.100	V
Output Voltage 5.0 V Version	V_{OUT}	$0\text{ mA} \leq I_{OUT} \leq 150\text{ mA}$ $5.5\text{ V} \leq V_{IN} \leq 28\text{ V}$ $-40^\circ\text{C} \leq T_J \leq 125^\circ\text{C}$	4.900	5.000	5.100	V
Output Voltage 3.3 V Version	V_{OUT}	$0.1\text{ mA} \leq I_{OUT} \leq 150\text{ mA}$ (Note 4) $4.5\text{ V} \leq V_{IN} \leq 28\text{ V}$	3.234	3.300	3.366	V
Line Regulation 5.0 V Version	ΔV_{OUT} vs. V_{IN}	$I_{OUT} = 5.0\text{ mA}$ $6.0\text{ V} \leq V_{IN} \leq 28\text{ V}$	-25	5.0	+25	mV
Line Regulation 3.3 V Version	ΔV_{OUT} vs. V_{IN}	$I_{OUT} = 5.0\text{ mA}$ $4.5\text{ V} \leq V_{IN} \leq 28\text{ V}$	-25	5.0	+25	mV
Load Regulation	ΔV_{OUT} vs. I_{OUT}	$1.0\text{ mA} \leq I_{OUT} \leq 150\text{ mA}$ (Note 4)	-35	5.0	+35	mV
Dropout Voltage 5.0 V Version	$V_{IN} - V_{OUT}$	$I_Q = 100\text{ mA}$ (Notes 4 & 5) $I_Q = 150\text{ mA}$ (Notes 4 & 5)	-	265 315	500 600	mV
Dropout Voltage 3.3 V Version	$V_{IN} - V_{OUT}$	$I_Q = 100\text{ mA}$ (Notes 4 & 7) $I_Q = 150\text{ mA}$ (Notes 4 & 7)	-	-	1.266 1.266	V
Quiescent Current	I_q	$I_{OUT} = 100\text{ }\mu\text{A}$ $T_J = 25^\circ\text{C}$ $T_J = -40^\circ\text{C}$ to $+85^\circ\text{C}$	-	21 22	29 30	μA
Active Ground Current	$I_{G(ON)}$	$I_{OUT} = 50\text{ mA}$ (Note 4) $I_{OUT} = 150\text{ mA}$ (Note 4)	-	1.3 8.0	3 15	mA
Power Supply Rejection	PSRR	$V_{RIPPLE} = 0.5\text{ V}_{P-P}$, $F = 100\text{ Hz}$	-	67	-	dB
Output Capacitor for Stability 5.0 V Version	C_{OUT} ESR	$I_{OUT} = 0.1\text{ mA}$ to 150 mA (Note 4)	10 -	- -	- 9.0	μF Ω
Output Capacitor for Stability 3.3 V Version	C_{OUT} ESR	$I_{OUT} = 0.1\text{ mA}$ to 150 mA (Note 4)	22 -	- -	- 18	μF Ω

PROTECTION

Current Limit	$I_{OUT(LIM)}$	$V_{OUT} = 4.5\text{ V}$ (5.0 V Version) (Note 4) $V_{OUT} = 3.0\text{ V}$ (3.3 V Version) (Note 4)	150 150	- -	500 500	mA
Short Circuit Current Limit	$I_{OUT(SC)}$	$V_{OUT} = 0\text{ V}$ (Note 4)	100	-	500	mA
Thermal Shutdown Threshold	T_{TSD}	(Note 6)	150	-	200	°C

4. Use pulse loading to limit power dissipation.

5. Dropout voltage = $(V_{IN} - V_{OUT})$, measured when the output voltage has dropped 100 mV relative to the nominal value obtained with $V_{IN} = 13.5\text{ V}$.

6. Not tested in production. Limits are guaranteed by design.

7. $V_{DO} = V_{IN} - V_{OUT}$. For output voltage set to $< 4.5\text{ V}$, V_{DO} will be constrained by the minimum input voltage.

NCV8664

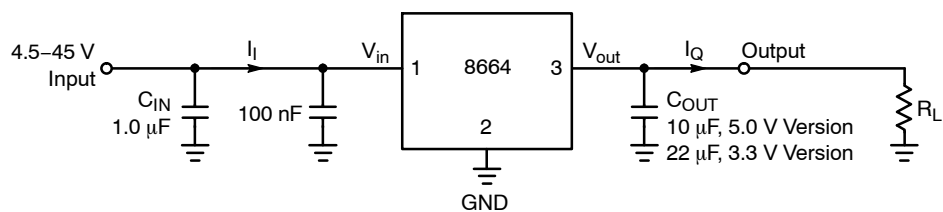

Figure 2. Measurement Circuit

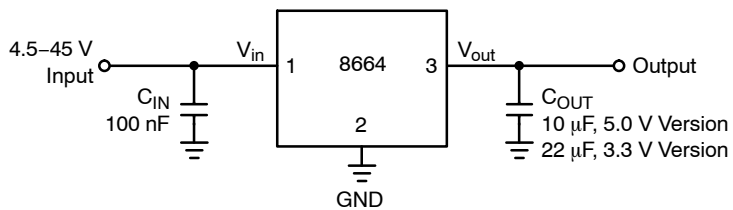

Figure 3. Applications Circuit

Typical Curves



Figure 4. ESR Characterization, 5.0 V Version



Figure 5. Output Voltage vs. Input Voltage, 5.0 V Version

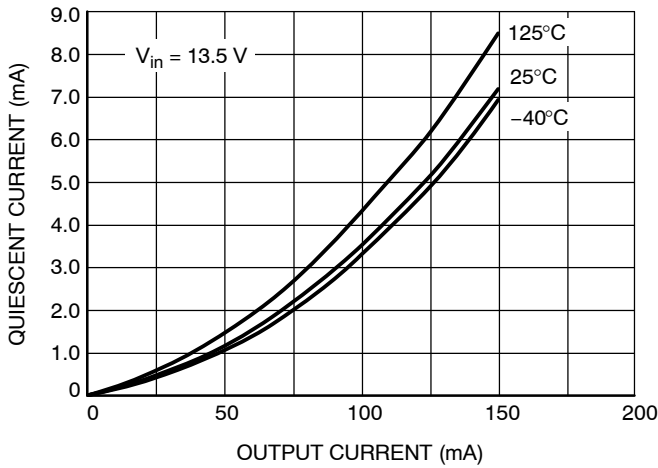

Figure 6. Current Consumption vs. Output Load, 5.0 V Version

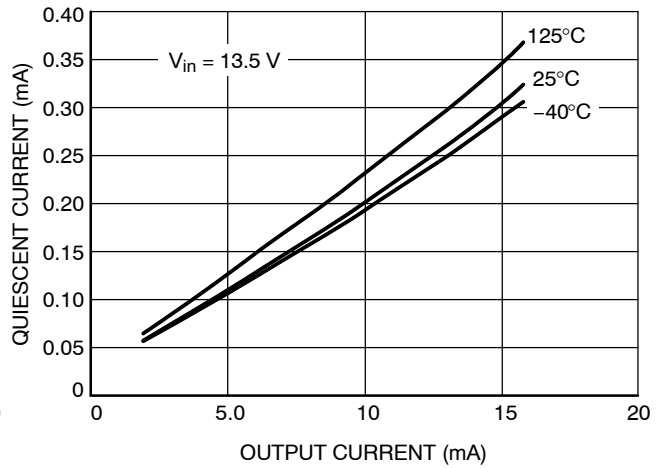

Figure 7. Current Consumption vs. Output Load (Low Load), 5.0 V Version

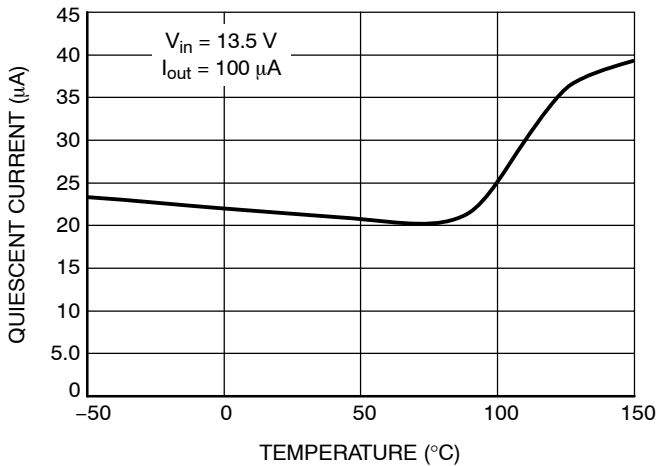

Figure 8. Quiescent Current vs. Temperature, 5.0 V Version

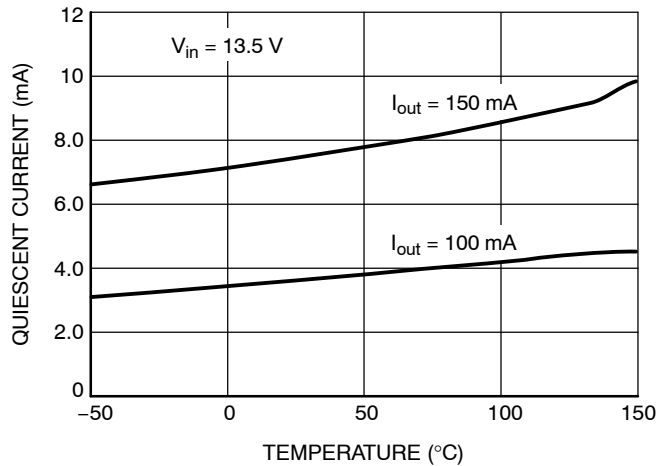

Figure 9. Quiescent Current vs. Temperature, 5.0 V Version

Typical Curves

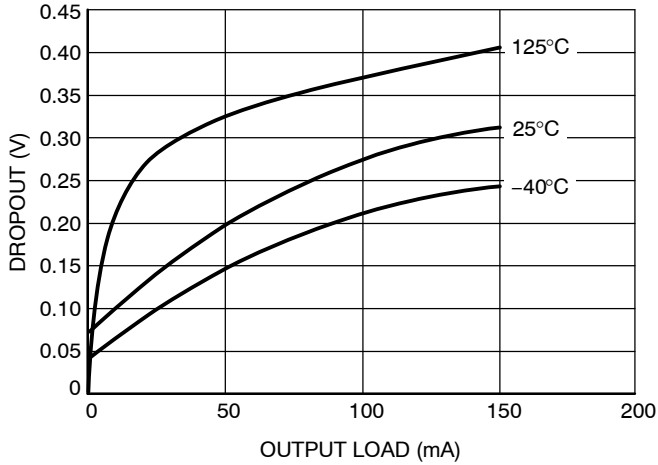

Figure 10. Dropout Voltage vs. Output Load, 5.0 V Version

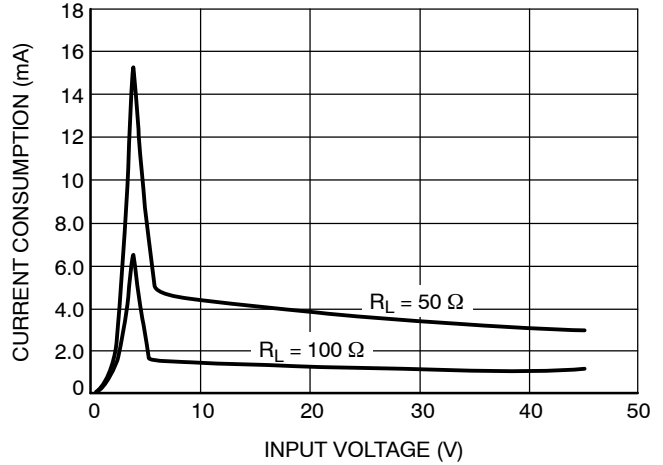

Figure 11. Current Consumption vs. Input Voltage, 5.0 V Version

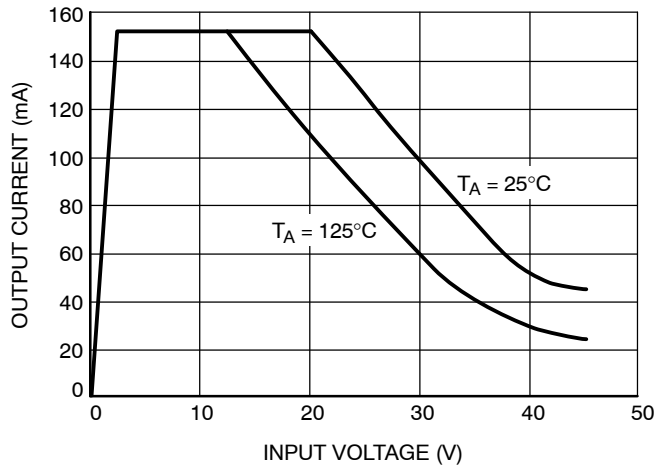

Figure 12. Output Current vs. Input Voltage, 5.0 V Version

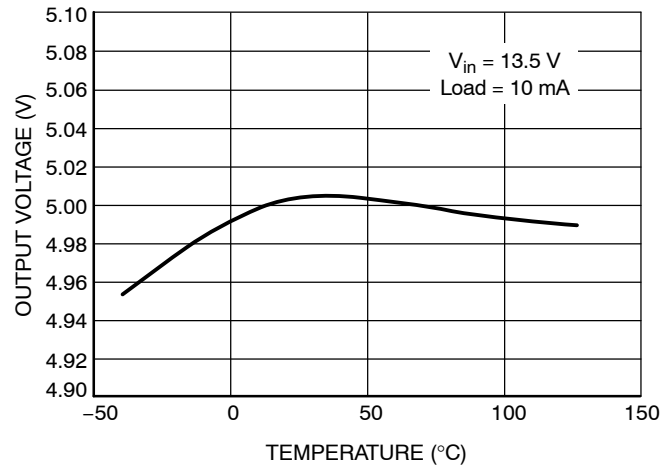

Figure 13. Output Voltage vs. Temperature, 5.0 V Version

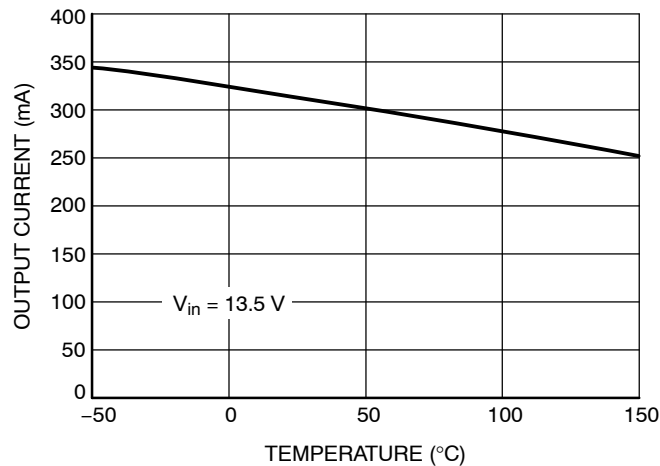

Figure 14. Current Limit vs. Temperature, 5.0 V Version

Typical Curves



Figure 15. ESR Stability, 3.3 V Version



Figure 16. Output Voltage vs. Input Voltage, 3.3 V Version

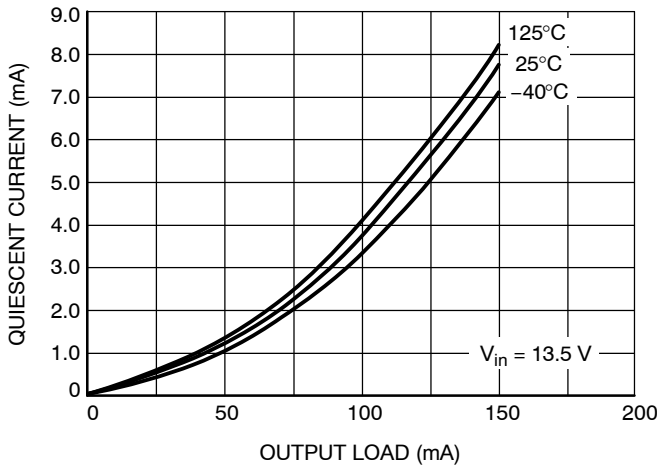

Figure 17. Current Consumption vs. Output Load, 3.3 V Version

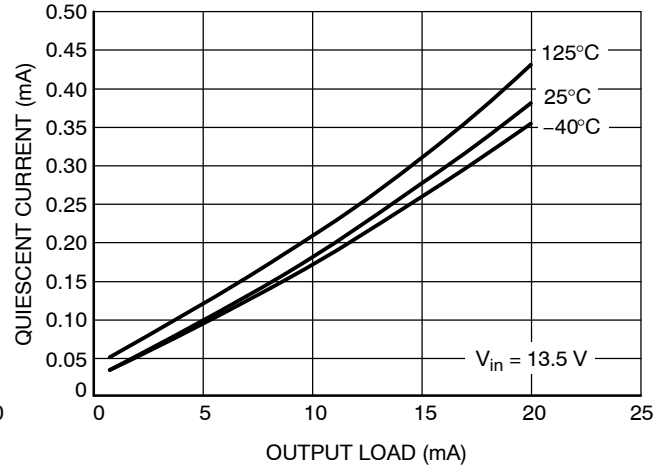

Figure 18. Current Consumption vs. Output Load (Low Load), 3.3 V Version

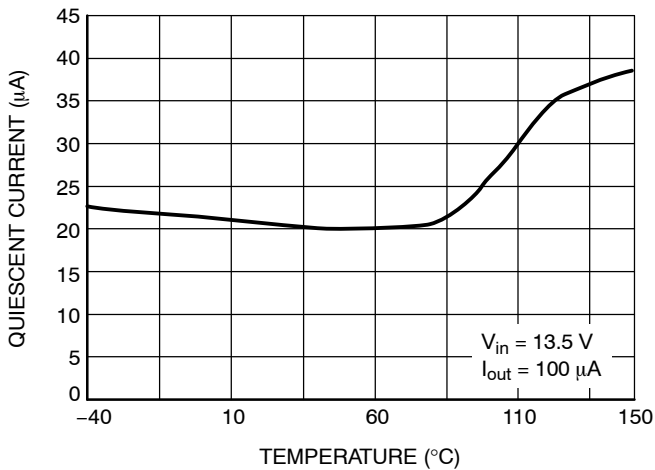

Figure 19. Quiescent Current vs. Temperature, 3.3 V Version

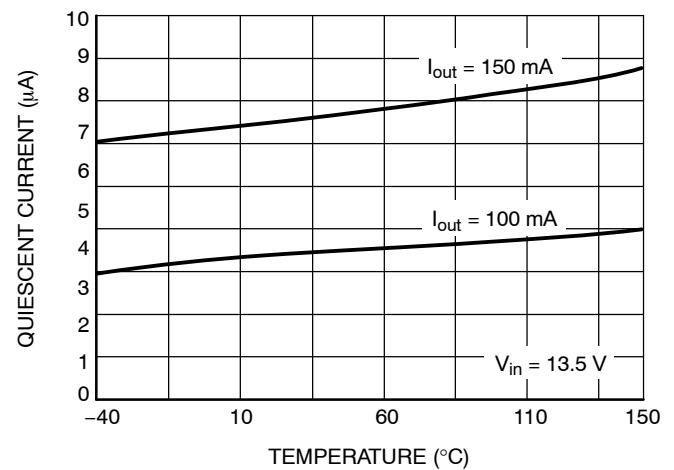

Figure 20. Quiescent Current vs. Temperature, 3.3 V Version

Typical Curves

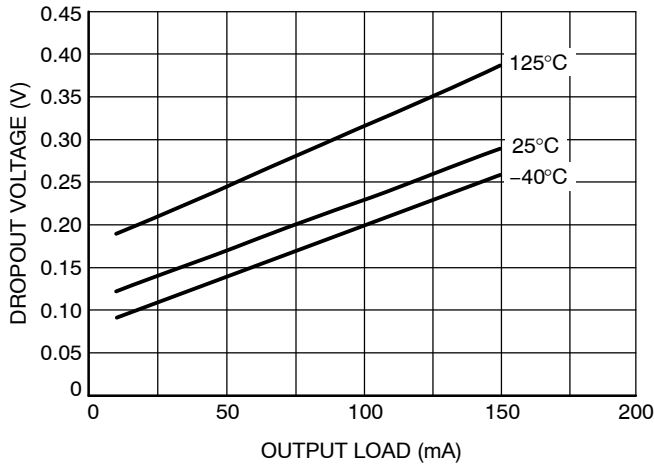

Figure 21. Dropout Voltage, 3.3 V Version

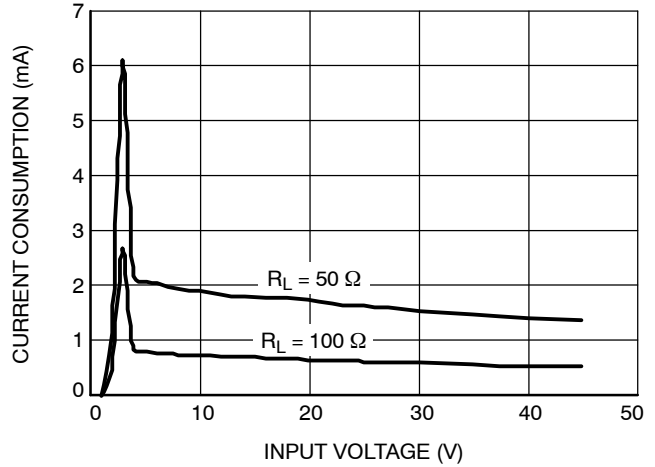

Figure 22. Current Consumption vs. Input Voltage, 3.3 V Version

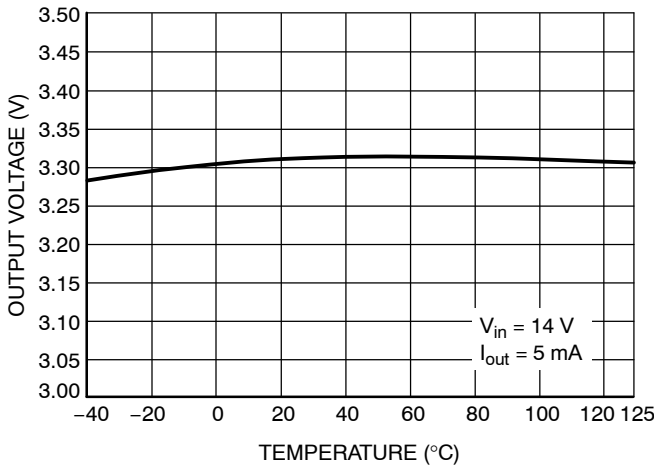

Figure 23. Output Voltage vs. Temperature, 3.3 V Version

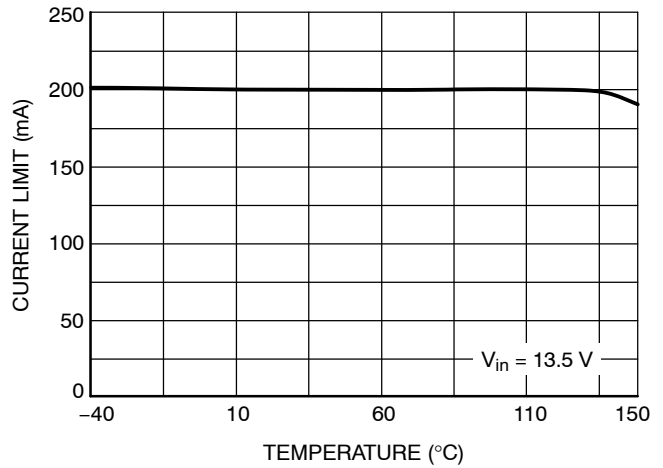

Figure 24. Short Circuit Current Limit vs. Temperature, 3.3 V Version

Circuit Description

The NCV8664 is a precision trimmed 3.3 V and 5.0 V fixed output regulator. Careful management of light load consumption combined with a low leakage process results in a typical quiescent current of 22 μ A. The device has current capability of 150 mA, with 600 mV of dropout voltage at full rated load current. The regulation is provided by a PNP pass transistor controlled by an error amplifier with a bandgap reference. The regulator is protected by both current limit and short circuit protection. Thermal shutdown occurs above 150°C to protect the IC during overloads and extreme ambient temperatures.

Regulator

The error amplifier compares the reference voltage to a sample of the output voltage (V_{out}) and drives the base of a PNP series pass transistor by a buffer. The reference is a bandgap design to give it a temperature-stable output. Saturation control of the PNP is a function of the load current and input voltage. Over saturation of the output power device is prevented, and quiescent current in the ground pin is minimized. The NCV8664 is equipped with foldback current protection. This protection is designed to reduce the current limit during an overcurrent situation.

Regulator Stability Considerations

The input capacitor C_{IN} in Figure 2 is necessary for compensating input line reactance. Possible oscillations caused by input inductance and input capacitance can be damped by using a resistor of approximately 1 Ω in series with C_{IN} . The output or compensation capacitor, C_{OUT} helps determine three main characteristics of a linear regulator: startup delay, load transient response and loop stability. The capacitor value and type should be based on cost, availability, size and temperature constraints. Tantalum, aluminum electrolytic, film, or ceramic capacitors are all acceptable solutions, however, attention must be paid to ESR constraints. The aluminum electrolytic capacitor is the least expensive solution, but, if the circuit operates at low temperatures (-25°C to -40°C), both the value and ESR of the capacitor will vary considerably. The capacitor manufacturer's data sheet usually provides this information. The value for the output capacitor C_{OUT} shown in Figure 2 should work for most applications; however, it is not necessarily the optimized solution. Stability is guaranteed at values $C_{OUT} \geq 10 \mu\text{F}$ and $\text{ESR} \leq 9 \Omega$ for 5.0 V version, and $C_{OUT} \geq 22 \mu\text{F}$ and $\text{ESR} \leq 18 \Omega$ for 3.3 V version, within the operating temperature range. Actual limits are shown in a graph in the Typical Performance Characteristics section.

Calculating Power Dissipation in a Single Output Linear Regulator

The maximum power dissipation for a single output regulator (Figure 3) is:

$$P_{D(\text{max})} = [V_{IN(\text{max})} - V_{OUT(\text{min})}] \cdot I_{Q(\text{max})} + V_{I(\text{max})} \cdot I_q \quad (\text{eq. 1})$$

Where:

$V_{IN(\text{max})}$ is the maximum input voltage,

$V_{OUT(\text{min})}$ is the minimum output voltage,

$I_{Q(\text{max})}$ is the maximum output current for the application, and I_q is the quiescent current the regulator consumes at $I_{Q(\text{max})}$.

Once the value of $P_{D(\text{Max})}$ is known, the maximum permissible value of $R_{\theta JA}$ can be calculated:

$$R_{\theta JA} = \frac{150^{\circ}\text{C} - T_A}{P_D} \quad (\text{eq. 2})$$

The value of $R_{\theta JA}$ can then be compared with those in the package section of the data sheet. Those packages with $R_{\theta JA}$'s less than the calculated value in Equation 2 will keep the die temperature below 150°C. In some cases, none of the packages will be sufficient to dissipate the heat generated by the IC, and an external heat sink will be required. The current flow and voltages are shown in the Measurement Circuit Diagram.

Heat Sinks

For proper heat sinking of the SOIC-8 Lead device, connect pins 5 – 8 to the heat sink.

A heat sink effectively increases the surface area of the package to improve the flow of heat away from the IC and into the surrounding air. Each material in the heat flow path between the IC and the outside environment will have a thermal resistance. Like series electrical resistances, these resistances are summed to determine the value of $R_{\theta JA}$:

$$R_{\theta JA} = R_{\theta JC} + R_{\theta CS} + R_{\theta SA} \quad (\text{eq. 3})$$

Where:

$R_{\theta JC}$ = the junction-to-case thermal resistance,

$R_{\theta CS}$ = the case-to-heat sink thermal resistance, and

$R_{\theta SA}$ = the heat sink-to-ambient thermal resistance.

$R_{\theta JA}$ appears in the package section of the data sheet.

Like $R_{\theta JA}$, it too is a function of package type. $R_{\theta CS}$ and $R_{\theta SA}$ are functions of the package type, heat sink and the interface between them. These values appear in data sheets of heat sink manufacturers. Thermal, mounting, and heat sinking are discussed in the ON Semiconductor application note AN1040/D, available on the ON Semiconductor Website.

NCV8664

EMC-Characteristics: Conducted Susceptibility

All EMC-Characteristics are based on limited samples and not part of production testing, according to 47A/658/CD IEC62132-4 (Direct Power Injection)

Direct Power Injection: 33 dBm forward power CW

Acceptance Criteria: Amplitude Dev. max 2% of Output Voltage

Test Conditions

Supply Voltage $V_{IN} = 12\text{ V}$
 Temperature $T_A = 23^\circ\text{C} \pm 5^\circ\text{C}$
 Load $R_L = 35\ \Omega$

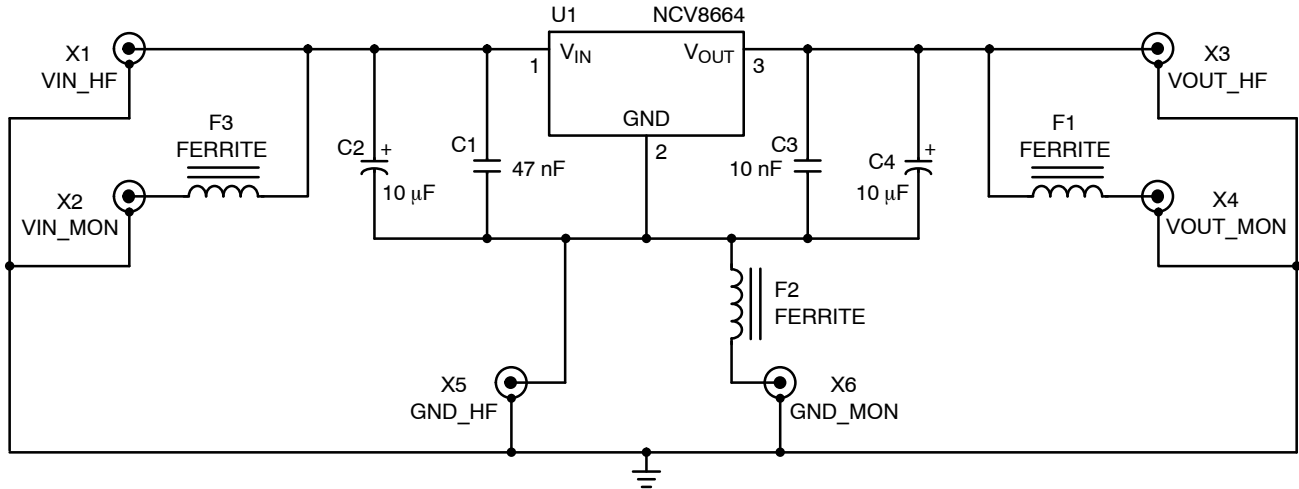

Figure 25. Test Circuit

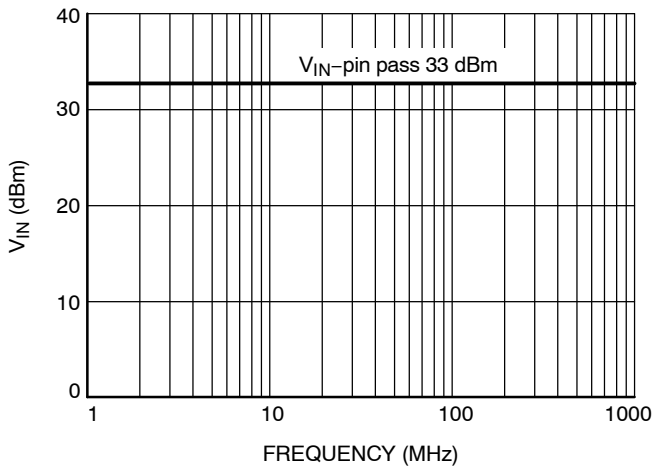

Figure 26. Typical V_{IN} -pin Susceptibility

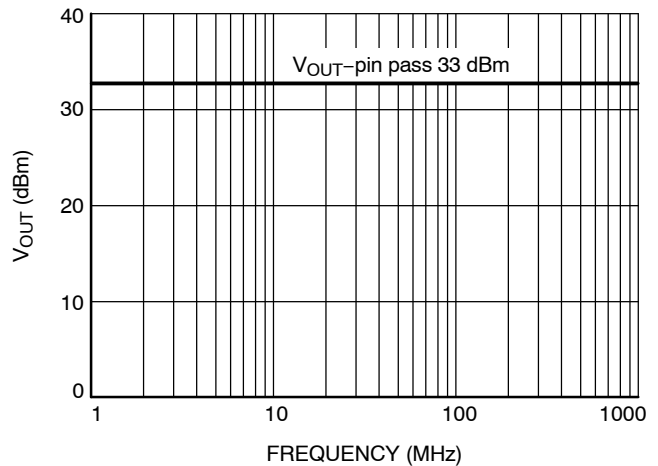

Figure 27. Typical V_{OUT} -pin Susceptibility

NCV8664

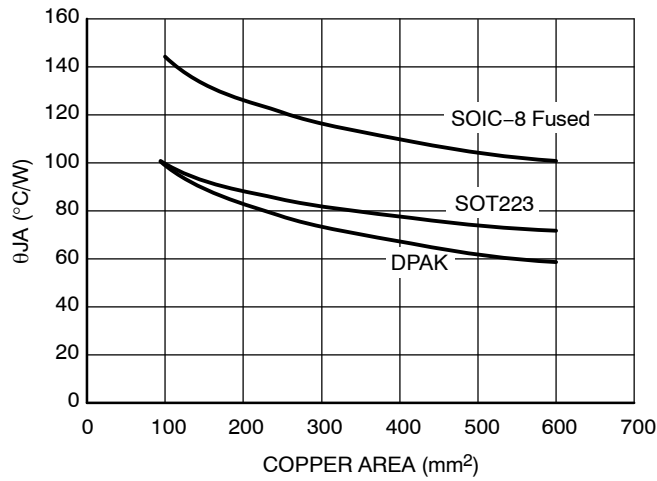

Figure 28. θ_{JA} vs. Copper Spreader Area

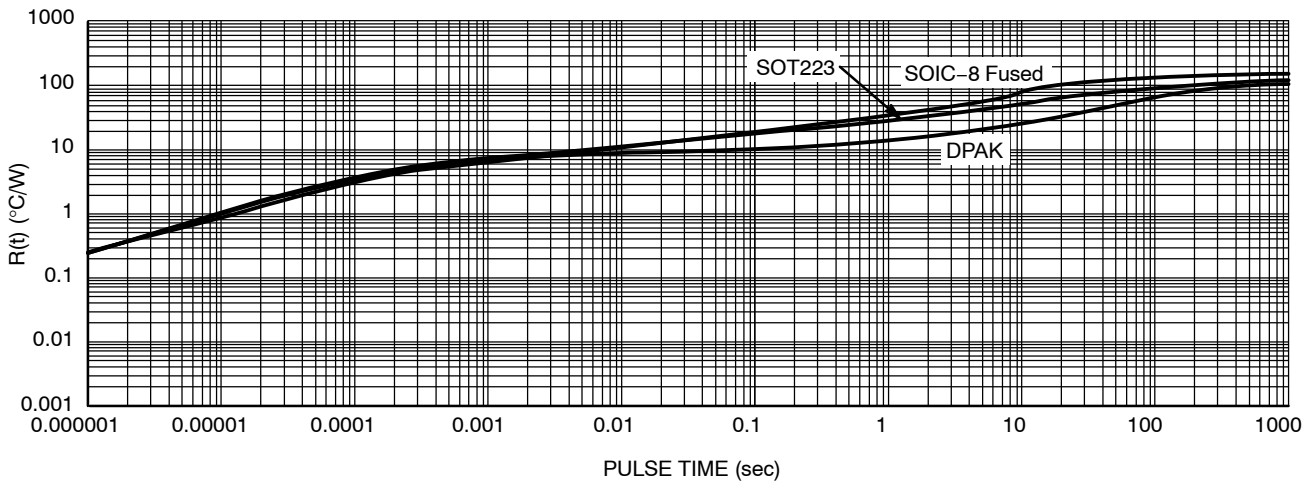

Figure 29. Single-Pulse Heating Curves

ORDERING INFORMATION

Device	Marking	Package	Shipping [†]
NCV8664D50R2G	V6645	SOIC-8 Fused (Pb-Free)	2500 / Tape & Reel
NCV8664D50G	V6645	SOIC-8 Fused (Pb-Free)	98 Units / Rail
NCV8664DT50RKG	V66450G	DPAK (Pb-Free)	2500 / Tape & Reel
NCV8664DT33RKG	V66433G	DPAK (Pb-Free)	2500 / Tape & Reel
NCV8664ST50T3G	V6645	SOT-223 (Pb-Free)	4000 / Tape & Reel
NCV8664ST33T3G	V6643	SOT-223 (Pb-Free)	4000 / Tape & Reel

[†] For information on tape and reel specifications, including part orientation and tape sizes, please refer to our Tape and Reel Packaging Specification Brochure, BRD8011/D.

NCV8664

PACKAGE DIMENSIONS

SOT-223 (TO-261)
CASE 318E-04
ISSUE M

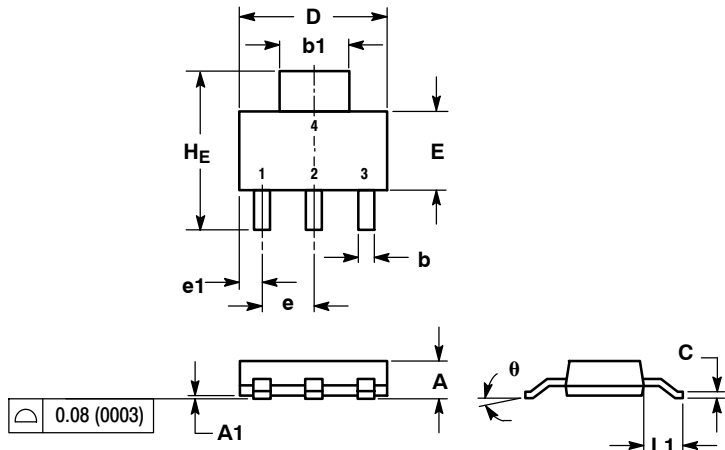

- NOTES:
1. DIMENSIONING AND TOLERANCING PER ANSI Y14.5M, 1982.
2. CONTROLLING DIMENSION: INCH.

DIM	MILLIMETERS			INCHES		
	MIN	NOM	MAX	MIN	NOM	MAX
A	1.50	1.63	1.75	0.060	0.064	0.068
A1	0.02	0.06	0.10	0.001	0.002	0.004
b	0.60	0.75	0.89	0.024	0.030	0.035
b1	2.90	3.06	3.20	0.115	0.121	0.126
c	0.24	0.29	0.35	0.009	0.012	0.014
D	6.30	6.50	6.70	0.249	0.256	0.263
E	3.30	3.50	3.70	0.130	0.138	0.145
e	2.20	2.30	2.40	0.087	0.091	0.094
e1	0.85	0.94	1.05	0.033	0.037	0.041
L1	1.50	1.75	2.00	0.060	0.069	0.078
HE	6.70	7.00	7.30	0.264	0.276	0.287
theta	0°	-	10°	0°	-	10°

SOLDERING FOOTPRINT

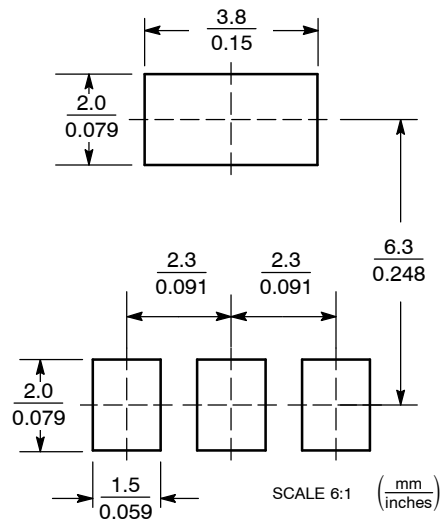

*For additional information on our Pb-Free strategy and soldering details, please download the ON Semiconductor Soldering and Mounting Techniques Reference Manual, SOLDERRM/D.

NCV8664

PACKAGE DIMENSIONS

DPAK (SINGLE GAUGE)
DT SUFFIX
CASE 369C-01
ISSUE D

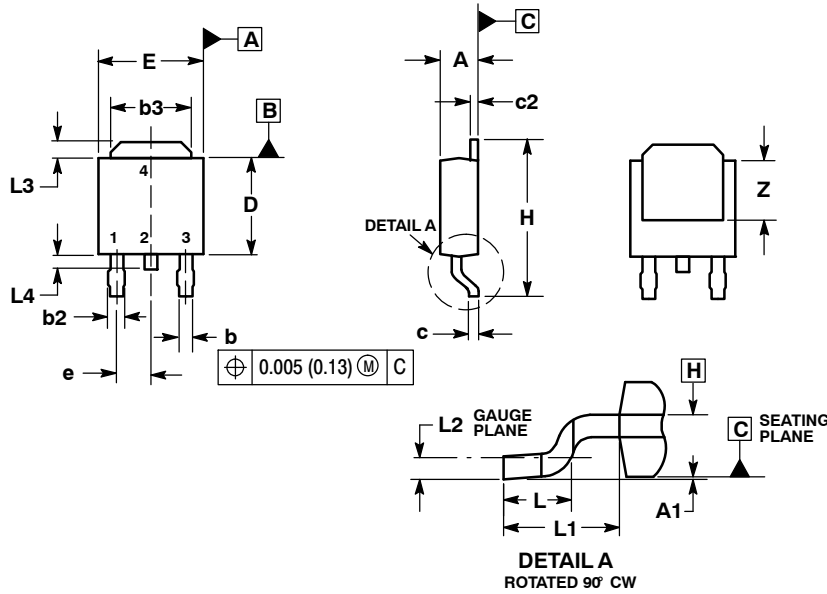

NOTES:

1. DIMENSIONING AND TOLERANCING PER ASME Y14.5M, 1994.
2. CONTROLLING DIMENSION: INCHES.
3. THERMAL PAD CONTOUR OPTIONAL WITHIN DIMENSIONS b3, L3 and Z.
4. DIMENSIONS D AND E DO NOT INCLUDE MOLD FLASH, PROTRUSIONS, OR BURRS. MOLD FLASH, PROTRUSIONS, OR GATE BURRS SHALL NOT EXCEED 0.006 INCHES PER SIDE.
5. DIMENSIONS D AND E ARE DETERMINED AT THE OUTERMOST EXTREMES OF THE PLASTIC BODY.
6. DATUMS A AND B ARE DETERMINED AT DATUM PLANE H.

DIM	INCHES		MILLIMETERS	
	MIN	MAX	MIN	MAX
A	0.086	0.094	2.18	2.38
A1	0.000	0.005	0.00	0.13
b	0.025	0.035	0.63	0.89
b2	0.030	0.045	0.76	1.14
b3	0.180	0.215	4.57	5.46
c	0.018	0.024	0.46	0.61
c2	0.018	0.024	0.46	0.61
D	0.235	0.245	5.97	6.22
E	0.250	0.265	6.35	6.73
e	0.090	BSC	2.29	BSC
H	0.370	0.410	9.40	10.41
L	0.055	0.070	1.40	1.78
L1	0.108	REF	2.74	REF
L2	0.020	BSC	0.51	BSC
L3	0.035	0.050	0.89	1.27
L4	---	0.040	---	1.01
Z	0.155	---	3.93	---

SOLDERING FOOTPRINT*

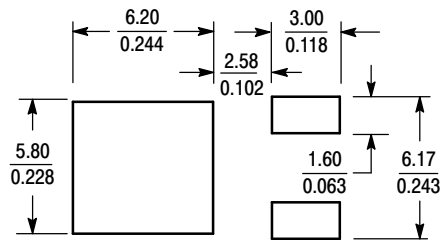

SCALE 3:1 $\left(\frac{\text{mm}}{\text{inches}}\right)$

*For additional information on our Pb-Free strategy and soldering details, please download the ON Semiconductor Soldering and Mounting Techniques Reference Manual, SOLDERRM/D.

NCV8664

PACKAGE DIMENSIONS

SOIC-8 NB CASE 751-07 ISSUE AJ

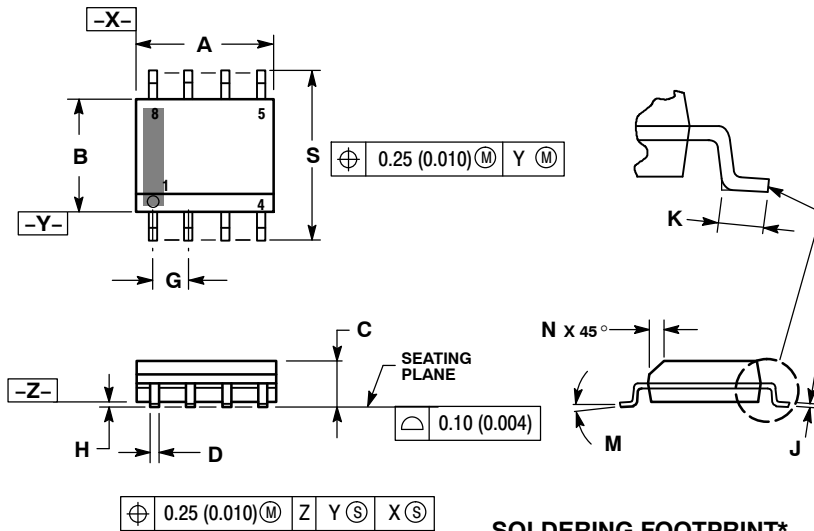

NOTES:

1. DIMENSIONING AND TOLERANCING PER ANSI Y14.5M, 1982.
2. CONTROLLING DIMENSION: MILLIMETER.
3. DIMENSION A AND B DO NOT INCLUDE MOLD PROTRUSION.
4. MAXIMUM MOLD PROTRUSION 0.15 (0.006) PER SIDE.
5. DIMENSION D DOES NOT INCLUDE DAMBAR PROTRUSION. ALLOWABLE DAMBAR PROTRUSION SHALL BE 0.127 (0.005) TOTAL IN EXCESS OF THE D DIMENSION AT MAXIMUM MATERIAL CONDITION.
6. 751-01 THRU 751-06 ARE OBSOLETE. NEW STANDARD IS 751-07.

DIM	MILLIMETERS		INCHES	
	MIN	MAX	MIN	MAX
A	4.80	5.00	0.189	0.197
B	3.80	4.00	0.150	0.157
C	1.35	1.75	0.053	0.069
D	0.33	0.51	0.013	0.020
G	1.27 BSC		0.050 BSC	
H	0.10	0.25	0.004	0.010
J	0.19	0.25	0.007	0.010
K	0.40	1.27	0.016	0.050
M	0°	8°	0°	8°
N	0.25	0.50	0.010	0.020
S	5.80	6.20	0.228	0.244

SOLDERING FOOTPRINT*

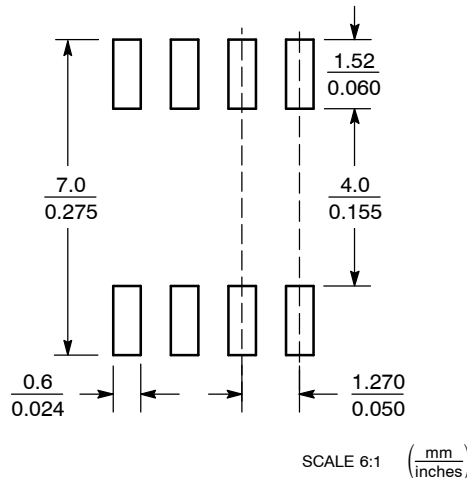

*For additional information on our Pb-Free strategy and soldering details, please download the ON Semiconductor Soldering and Mounting Techniques Reference Manual, SOLDERRM/D.

ON Semiconductor and are registered trademarks of Semiconductor Components Industries, LLC (SCILLC). SCILLC reserves the right to make changes without further notice to any products herein. SCILLC makes no warranty, representation or guarantee regarding the suitability of its products for any particular purpose, nor does SCILLC assume any liability arising out of the application or use of any product or circuit, and specifically disclaims any and all liability, including without limitation special, consequential or incidental damages. "Typical" parameters which may be provided in SCILLC data sheets and/or specifications can and do vary in different applications and actual performance may vary over time. All operating parameters, including "Typicals" must be validated for each customer application by customer's technical experts. SCILLC does not convey any license under its patent rights nor the rights of others. SCILLC products are not designed, intended, or authorized for use as components in systems intended for surgical implant into the body, or other applications intended to support or sustain life, or for any other application in which the failure of the SCILLC product could create a situation where personal injury or death may occur. Should Buyer purchase or use SCILLC products for any such unintended or unauthorized application, Buyer shall indemnify and hold SCILLC and its officers, employees, subsidiaries, affiliates, and distributors harmless against all claims, costs, damages, and expenses, and reasonable attorney fees arising out of, directly or indirectly, any claim of personal injury or death associated with such unintended or unauthorized use, even if such claim alleges that SCILLC was negligent regarding the design or manufacture of the part. SCILLC is an Equal Opportunity/Affirmative Action Employer. This literature is subject to all applicable copyright laws and is not for resale in any manner.

PUBLICATION ORDERING INFORMATION

LITERATURE FULFILLMENT:

Literature Distribution Center for ON Semiconductor
P.O. Box 5163, Denver, Colorado 80217 USA
Phone: 303-675-2175 or 800-344-3860 Toll Free USA/Canada
Fax: 303-675-2176 or 800-344-3867 Toll Free USA/Canada
Email: orderlit@onsemi.com

N. American Technical Support: 800-282-9855 Toll Free
USA/Canada
Europe, Middle East and Africa Technical Support:
Phone: 421 33 790 2910
Japan Customer Focus Center
Phone: 81-3-5773-3850

ON Semiconductor Website: www.onsemi.com

Order Literature: <http://www.onsemi.com/orderlit>

For additional information, please contact your local Sales Representative

NCV8664/D