

LOW DROPOUT CMOS VOLTAGE REGULATORwww.sii-ic.com

© Seiko Instruments Inc., 2000-2010

Rev.3.0_00

The S-818 Series is a positive voltage regulator developed by CMOS technology and featured by low dropout voltage, high output voltage accuracy and low current consumption. Built-in low on-resistance transistor provides low dropout voltage and large output current. A ceramic capacitor of 2 μ F or more can be used as an output capacitor. A shutdown circuit ensures long battery life. The SOT-23-5 miniaturized package and the SOT-89-5 package are recommended for configuring portable devices and large output current applications, respectively.

■ Features

- Low current consumption: At operation mode: Typ. 30 μ A, Max. 40 μ A
At shutdown mode: Typ. 100 nA, Max. 500 nA
- Output voltage: 2.0 to 6.0 V, selectable in 0.1 V steps.
- High accuracy output voltage: $\pm 2.0\%$
- Peak output current: 200 mA capable (3.0 V output product, $V_{IN}=4$ V)^{*1}
300 mA capable (5.0 V output product, $V_{IN}=6$ V)^{*1}
- Low dropout voltage: Typ. 170 mV (5.0 V output product, $I_{OUT}=60$ mA)
- A ceramic capacitor (2 μ F or more) can be used as an output capacitor.
- Built-in shutdown circuit
- Lead-free, Sn 100%, halogen-free^{*2}

*1. Attention should be paid to the power dissipation of the package when the output current is large.

*2. Refer to "■ Product Name Structure" for details.

■ Applications

- Power source for battery-powered devices, personal communication devices and home electric/electronic appliances

■ Packages

- SOT-23-5
- SOT-89-5

■ Block Diagram

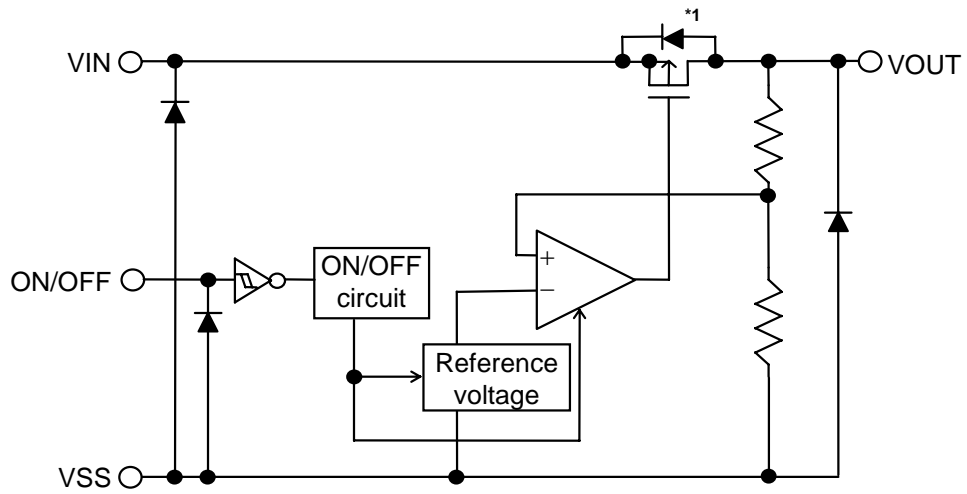

*1. Parasitic diode

Figure 1

■ **Product Name Structure**

1. **Product Name**

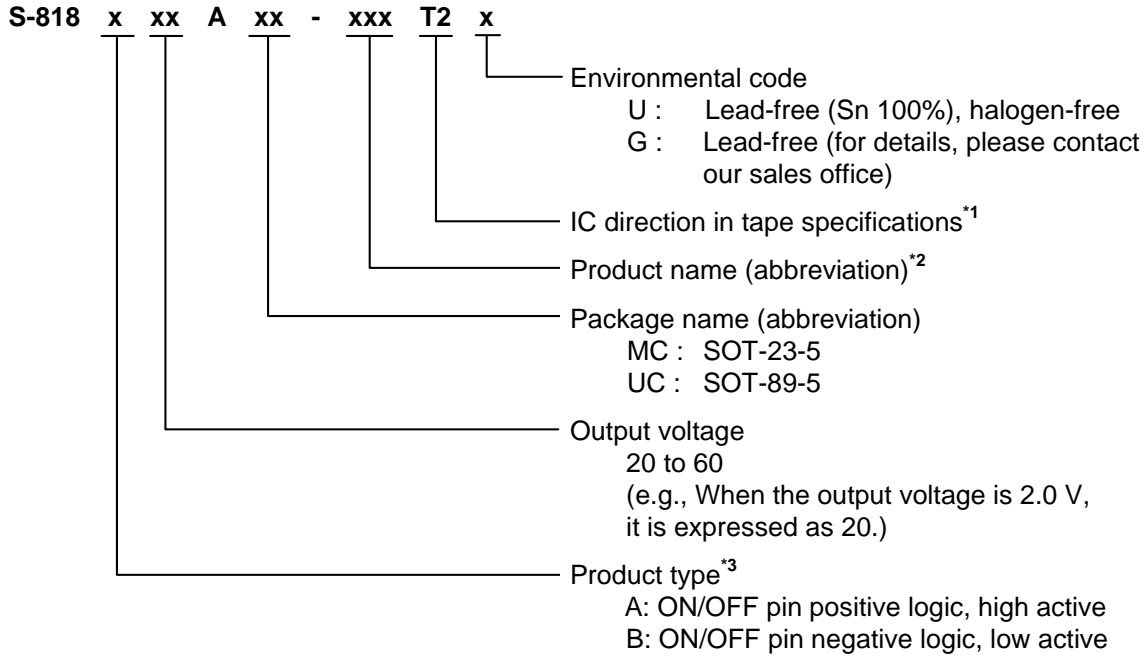

*1. Refer to the tape specifications at the end of this book.
 *2. Refer to the "Table 1" under the "3. Product name list".
 *3. Refer to "3. ON/OFF pin (Shutdown pin)" in the "■ Operation".

2. **Package**

| Package Name | Drawing Code | | |
|--------------|--------------|--------------|--------------|
| | Package | Tape | Reel |
| SOT-23-5 | MP005-A-P-SD | MP005-A-C-SD | MP005-A-R-SD |
| SOT-89-5 | UP005-A-P-SD | UP005-A-C-SD | UP005-A-R-SD |

3. Product name list

Table 1

| Output Voltage | SOT-23-5 | SOT-89-5 |
|----------------|--------------------|--------------------|
| 2.0 V±2.0% | S-818A20AMC-BGAT2x | S-818A20AUC-BGAT2x |
| 2.1 V±2.0% | S-818A21AMC-BGBT2x | S-818A21AUC-BGBT2x |
| 2.2 V±2.0% | S-818A22AMC-BGCT2x | S-818A22AUC-BGCT2x |
| 2.3 V±2.0% | S-818A23AMC-BGDT2x | S-818A23AUC-BGDT2x |
| 2.4 V±2.0% | S-818A24AMC-BGET2x | S-818A24AUC-BGET2x |
| 2.5 V±2.0% | S-818A25AMC-BGFT2x | S-818A25AUC-BGFT2x |
| 2.6 V±2.0% | S-818A26AMC-BGGT2x | S-818A26AUC-BGGT2x |
| 2.7 V±2.0% | S-818A27AMC-BGHT2x | S-818A27AUC-BGHT2x |
| 2.8 V±2.0% | S-818A28AMC-BGIT2x | S-818A28AUC-BGIT2x |
| 2.9 V±2.0% | S-818A29AMC-BGJT2x | S-818A29AUC-BGJT2x |
| 3.0 V±2.0% | S-818A30AMC-BGKT2x | S-818A30AUC-BGKT2x |
| 3.1 V±2.0% | S-818A31AMC-BGLT2x | S-818A31AUC-BGLT2x |
| 3.2 V±2.0% | S-818A32AMC-BGMT2x | S-818A32AUC-BGMT2x |
| 3.3 V±2.0% | S-818A33AMC-BGNT2x | S-818A33AUC-BGNT2x |
| 3.4 V±2.0% | S-818A34AMC-BGOT2x | S-818A34AUC-BGOT2x |
| 3.5 V±2.0% | S-818A35AMC-BGPT2x | S-818A35AUC-BGPT2x |
| 3.6 V±2.0% | S-818A36AMC-BGQT2x | S-818A36AUC-BGQT2x |
| 3.7 V±2.0% | S-818A37AMC-BGRT2x | S-818A37AUC-BGRT2x |
| 3.8 V±2.0% | S-818A38AMC-BGST2x | S-818A38AUC-BGST2x |
| 3.9 V±2.0% | S-818A39AMC-BGTT2x | S-818A39AUC-BGTT2x |
| 4.0 V±2.0% | S-818A40AMC-BGUT2x | S-818A40AUC-BGUT2x |
| 4.1 V±2.0% | S-818A41AMC-BGVT2x | S-818A41AUC-BGVT2x |
| 4.2 V±2.0% | S-818A42AMC-BGWT2x | S-818A42AUC-BGWT2x |
| 4.3 V±2.0% | S-818A43AMC-BGXT2x | S-818A43AUC-BGXT2x |
| 4.4 V±2.0% | S-818A44AMC-BGYT2x | S-818A44AUC-BGYT2x |
| 4.5 V±2.0% | S-818A45AMC-BGZT2x | S-818A45AUC-BGZT2x |
| 4.6 V±2.0% | S-818A46AMC-BHAT2x | S-818A46AUC-BHAT2x |
| 4.7 V±2.0% | S-818A47AMC-BHBT2x | S-818A47AUC-BHBT2x |
| 4.8 V±2.0% | S-818A48AMC-BHCT2x | S-818A48AUC-BHCT2x |
| 4.9 V±2.0% | S-818A49AMC-BHDT2x | S-818A49AUC-BHDT2x |
| 5.0 V±2.0% | S-818A50AMC-BHET2x | S-818A50AUC-BHET2x |
| 5.1 V±2.0% | S-818A51AMC-BHFT2x | S-818A51AUC-BHFT2x |
| 5.2 V±2.0% | S-818A52AMC-BHGT2x | S-818A52AUC-BHGT2x |
| 5.3 V±2.0% | S-818A53AMC-BHHT2x | S-818A53AUC-BHHT2x |
| 5.4 V±2.0% | S-818A54AMC-BHIT2x | S-818A54AUC-BHIT2x |
| 5.5 V±2.0% | S-818A55AMC-BHJT2x | S-818A55AUC-BHJT2x |
| 5.6 V±2.0% | S-818A56AMC-BHKT2x | S-818A56AUC-BHKT2x |
| 5.7 V±2.0% | S-818A57AMC-BHLT2x | S-818A57AUC-BHLT2x |
| 5.8 V±2.0% | S-818A58AMC-BHMT2x | S-818A58AUC-BHMT2x |
| 5.9 V±2.0% | S-818A59AMC-BHNT2x | S-818A59AUC-BHNT2x |
| 6.0 V±2.0% | S-818A60AMC-BHOT2x | S-818A60AUC-BHOT2x |

Remark 1. Please contact our sales office for type B products.

2. x: G or U

3. Please select products of environmental code = U for Sn 100%, halogen-free products.

■ **Pin Configurations**

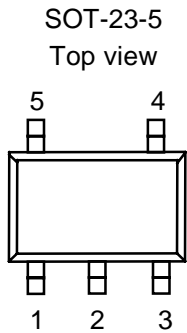

Figure 2

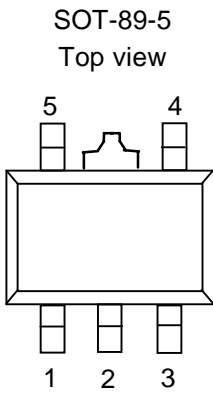

Figure 3

Table 2

| Pin No. | Symbol | Pin description |
|---------|------------------|--------------------|
| 1 | VIN | Input voltage pin |
| 2 | VSS | GND pin |
| 3 | ON/OFF | Shutdown pin |
| 4 | NC ^{*1} | No connection |
| 5 | VOUT | Output voltage pin |

*1. The NC pin is electrically open.
The NC pin can be connected to VIN or VSS.

Table 3

| Pin No. | Symbol | Pin description |
|---------|------------------|--------------------|
| 1 | VOUT | Output voltage pin |
| 2 | VSS | GND pin |
| 3 | NC ^{*1} | No connection |
| 4 | ON/OFF | Shutdown pin |
| 5 | VIN | Input voltage pin |

*1. The NC pin is electrically open.
The NC pin can be connected to VIN or VSS.

■ **Absolute Maximum Ratings**

Table 4

(Ta=25°C unless otherwise specified)

| Item | Symbol | Absolute Maximum Rating | Unit |
|-------------------------------|--------------|------------------------------|---------------------------------|
| Input voltage | V_{IN} | $V_{SS}-0.3$ to $V_{SS}+12$ | V |
| | $V_{ON/OFF}$ | $V_{SS}-0.3$ to $V_{SS}+12$ | V |
| Output voltage | V_{OUT} | $V_{SS}-0.3$ to $V_{IN}+0.3$ | V |
| Power dissipation | SOT-23-5 | P_D | 250 (When not mounted on board) |
| | | | 600 ^{*1} |
| | SOT-89-5 | P_D | 500 (When not mounted on board) |
| | | | 1000 ^{*1} |
| Operating ambient temperature | T_{opr} | -40 to +85 | °C |
| Storage temperature | T_{stg} | -40 to +125 | °C |

*1. When mounted on board
 [Mounted on board]

- (1) Board size : 114.3 mm × 76.2 mm × t1.6 mm
- (2) Board name : JEDEC STANDARD51-7

Caution The absolute maximum ratings are rated values exceeding which the product could suffer physical damage. These values must therefore not be exceeded under any conditions.

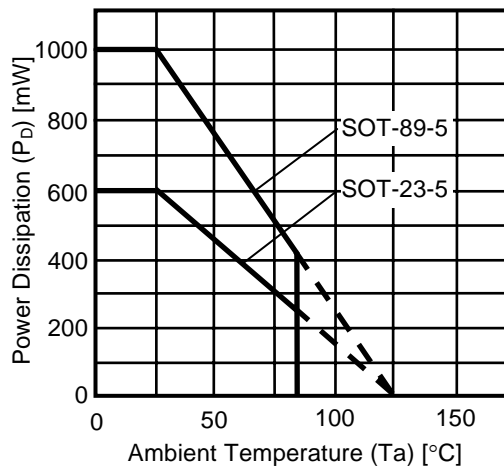

Figure 4 Power Dissipation of Package (When Mounted on Board)

LOW DROPOUT CMOS VOLTAGE REGULATOR
S-818 Series

Rev.3.0_00

■ **Electrical Characteristics**

Table 5

(Ta=25°C unless otherwise specified)

| Parameter | Symbol | Conditions | Min. | Typ. | Max. | Unit | Test circuit | |
|------------------------------------------------------|-------------------------------------------------------|----------------------------------------------------------------------------------|---------------------------------|-------------------|--------------------------|--------|--------------|---|
| Output voltage ^{*1} | $V_{OUT(E)}$ | $V_{IN}=V_{OUT(S)}+1$ V, $I_{OUT}=30$ mA | $V_{OUT(S)} \times 0.98$ | $V_{OUT(S)}$ | $V_{OUT(S)} \times 1.02$ | V | 1 | |
| Output current ^{*2} | I_{OUT} | $V_{OUT(S)}+1$ V ≤ $V_{IN} \leq 10$ V | 2.0 V ≤ $V_{OUT(S)} \leq 2.4$ V | 100 ^{*5} | — | — | mA | 3 |
| | | | 2.5 V ≤ $V_{OUT(S)} \leq 2.9$ V | 150 ^{*5} | — | — | mA | 3 |
| | | | 3.0 V ≤ $V_{OUT(S)} \leq 3.9$ V | 200 ^{*5} | — | — | mA | 3 |
| | | | 4.0 V ≤ $V_{OUT(S)} \leq 4.9$ V | 250 ^{*5} | — | — | mA | 3 |
| | | | 5.0 V ≤ $V_{OUT(S)} \leq 6.0$ V | 300 ^{*5} | — | — | mA | 3 |
| Dropout voltage ^{*3} | V_{drop} | $I_{OUT}=60$ mA | 2.0 V ≤ $V_{OUT(S)} \leq 2.4$ V | — | 0.51 | 0.87 | V | 1 |
| | | | 2.5 V ≤ $V_{OUT(S)} \leq 2.9$ V | — | 0.38 | 0.61 | V | 1 |
| | | | 3.0 V ≤ $V_{OUT(S)} \leq 3.4$ V | — | 0.30 | 0.44 | V | 1 |
| | | | 3.5 V ≤ $V_{OUT(S)} \leq 3.9$ V | — | 0.24 | 0.33 | V | 1 |
| | | | 4.0 V ≤ $V_{OUT(S)} \leq 4.4$ V | — | 0.20 | 0.26 | V | 1 |
| | | | 4.5 V ≤ $V_{OUT(S)} \leq 4.9$ V | — | 0.18 | 0.22 | V | 1 |
| | | | 5.0 V ≤ $V_{OUT(S)} \leq 5.4$ V | — | 0.17 | 0.21 | V | 1 |
| 5.5 V ≤ $V_{OUT(S)} \leq 6.0$ V | — | 0.17 | 0.20 | V | 1 | | | |
| Line regulation 1 | $\frac{\Delta V_{OUT1}}{\Delta V_{IN} \cdot V_{OUT}}$ | $V_{OUT(S)}+0.5$ V ≤ $V_{IN} \leq 10$ V, $I_{OUT}=30$ mA | — | 0.05 | 0.2 | %/V | 1 | |
| Line regulation 2 | $\frac{\Delta V_{OUT2}}{\Delta V_{IN} \cdot V_{OUT}}$ | $V_{OUT(S)}+0.5$ V ≤ $V_{IN} \leq 10$ V, $I_{OUT}=10$ μA | — | 0.05 | 0.2 | %/V | 1 | |
| Load regulation | ΔV_{OUT3} | $V_{IN}=V_{OUT(S)}+1$ V, $10 \mu A \leq I_{OUT} \leq 80$ mA | — | 30 | 50 | mV | 1 | |
| Output voltage temperature coefficient ^{*4} | $\frac{\Delta V_{OUT}}{\Delta T_a \cdot V_{OUT}}$ | $V_{IN}=V_{OUT(S)}+1$ V, $I_{OUT}=30$ mA, $-40^\circ C \leq T_a \leq 85^\circ C$ | — | ±100 | — | ppm/°C | 1 | |
| Current consumption at operation | I_{SS1} | $V_{IN}=V_{OUT(S)}+1$ V, ON/OFF pin=ON, no load | — | 30 | 40 | μA | 2 | |
| Current consumption at shutdown | I_{SS2} | $V_{IN}=V_{OUT(S)}+1$ V, ON/OFF pin=OFF, no load | — | 0.1 | 0.5 | μA | 2 | |
| Input voltage | V_{IN} | — | — | — | 10 | V | 1 | |
| Shutdown pin input voltage "H" | V_{SH} | $V_{IN}=V_{OUT(S)}+1$ V, $R_L=1$ kΩ, Judged by V_{OUT} output level. | 1.5 | — | — | V | 4 | |
| Shutdown pin input voltage "L" | V_{SL} | $V_{IN}=V_{OUT(S)}+1$ V, $R_L=1$ kΩ, Judged by V_{OUT} output level. | — | — | 0.3 | V | 4 | |
| Shutdown pin input current "H" | I_{SH} | $V_{IN}=V_{OUT(S)}+1$ V, $V_{ON/OFF}=7$ V | -0.1 | — | 0.1 | μA | 4 | |
| Shutdown pin input current "L" | I_{SL} | $V_{IN}=V_{OUT(S)}+1$ V, $V_{ON/OFF}=0$ V | -0.1 | — | 0.1 | μA | 4 | |
| Ripple rejection | $ RR $ | $V_{IN}=V_{OUT(S)}+1$ V, $f=100$ Hz, $\Delta V_{rip}=0.5$ V p-p, $I_{OUT}=30$ mA | — | 45 | — | dB | 5 | |

- *1. $V_{OUT(S)}$ =Specified output voltage
 $V_{OUT(E)}$ =Effective output voltage
i.e., The output voltage when fixing I_{OUT} (=30 mA) and inputting $V_{OUT(S)}+1.0$ V.
- *2. Output current at which output voltage becomes 95 % of $V_{OUT(E)}$ after gradually increasing output current.
- *3. $V_{drop}=V_{IN1}^*1-(V_{OUT(E)}\times 0.98)$
 - *1. The Input voltage at which output voltage becomes 98 % of $V_{OUT(E)}$ after gradually decreasing input voltage.
- *4. Output voltage shift by temperature [mV/°C] is calculated using the following equation.
$$\frac{\Delta V_{OUT}}{\Delta T_a} [mV/^\circ C]^*1 = V_{OUT(S)} [V]^*2 \times \frac{\Delta V_{OUT}}{\Delta T_a \bullet V_{OUT}} [ppm/^\circ C]^*3 \div 1000$$
 - *1. Temperature change ratio for output voltage
 - *2. Specified output voltage
 - *3. Output voltage temperature coefficient
- *5. These figures mean that every part can supply output current at least to these values

■ **Test Circuits**

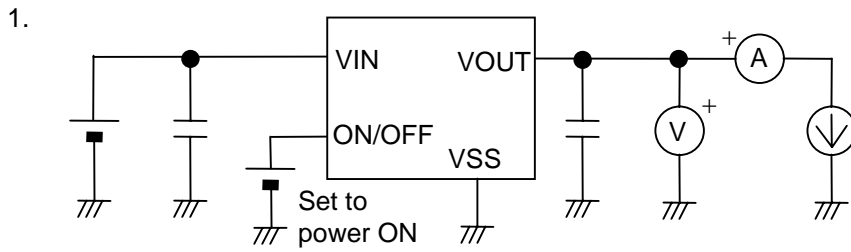

Figure 5

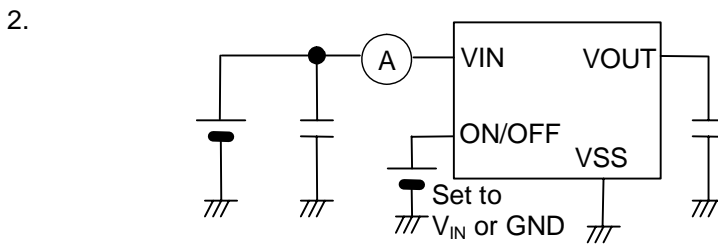

Figure 6

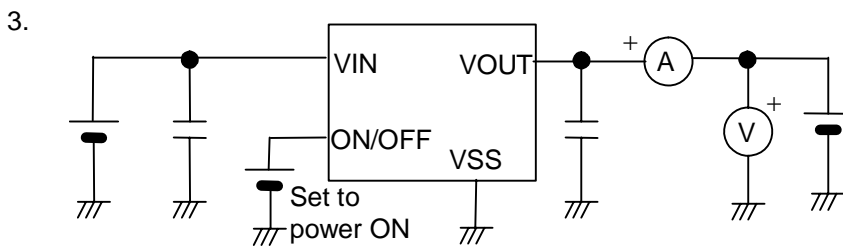

Figure 7

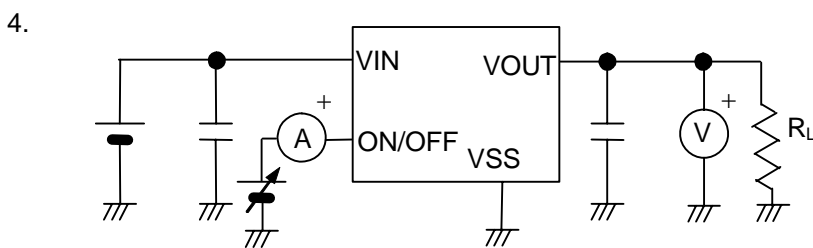

Figure 8

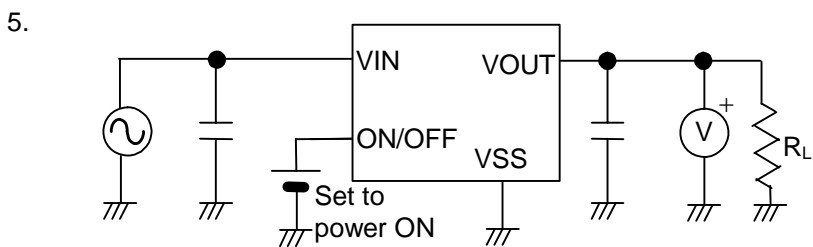

Figure 9

■ Application Conditions

| | |
|-------------------------------------|----------------------|
| Input capacitor (C_{IN}): | 0.47 μ F or more |
| Output capacitor (C_L): | 2 μ F or more |
| Equivalent series resistor (ESR): | 10 Ω or less |
| Input series resistor (R_{IN}): | 10 Ω or less |

Caution A general series regulator may oscillate, depending on the external components selected. Check that no oscillation occurs with the application using the above capacitor.

■ Standard Circuit

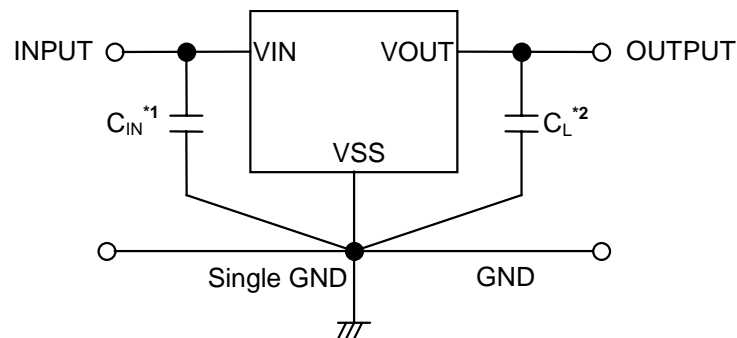

*1. C_{IN} is a capacitor used to stabilize input. Use a capacitor of 0.47 μ F or more

*2. In addition to a tantalum capacitor, a ceramic capacitor of 2.0 μ F or more can be used for C_L .

Figure 10

Caution The above connection diagram and constant will not guarantee successful operation. Perform through evaluation using the actual application to set the constant.

■ Technical Terms

1. Low dropout voltage regulator

The low dropout voltage regulator is a voltage regulator having a low dropout voltage characteristic due to the internal low on-resistance transistor.

2. Output voltage (V_{OUT})

The accuracy of the output voltage is ensured at $\pm 2.0\%$ under the specified conditions of input voltage, output current, and temperature, which differ product by product.

Caution When the above conditions are changed, the output voltage may vary and go out of the accuracy range of the output voltage. Refer to the “■ Electrical Characteristics” and “■ Characteristics” for details.

3. Line regulation 1 (ΔV_{OUT1}) and Line regulation 2 (ΔV_{OUT2})

Line regulation indicates the input voltage dependence of the output voltage. The value shows how much the output voltage changes due to the change of the input voltage when the output current is kept constant.

4. Load regulation (ΔV_{OUT3})

Load regulation indicates the output current dependence of output voltage. The value shows how much the output voltage changes due to the change of the output current when the input voltage is kept constant.

5. Dropout voltage (V_{drop})

Let V_{IN1} be an input voltage where the output voltage falls to the 98 % of the actual output voltage ($V_{OUT(E)}$) when gradually decreasing input voltage. The dropout voltage is the difference between the V_{IN1} and the resultant output voltage defined as following equation.

$$V_{drop} = V_{IN1} - (V_{OUT(E)} \times 0.98)$$

6. Temperature coefficient of output voltage $\left(\frac{\Delta V_{OUT}}{\Delta T_a \bullet V_{OUT}} \right)$

The output voltage lies in the shaded area in the whole operating temperature shown in **Figure 11** when the temperature coefficient of the output voltage is ± 100 ppm/ $^{\circ}\text{C}$.

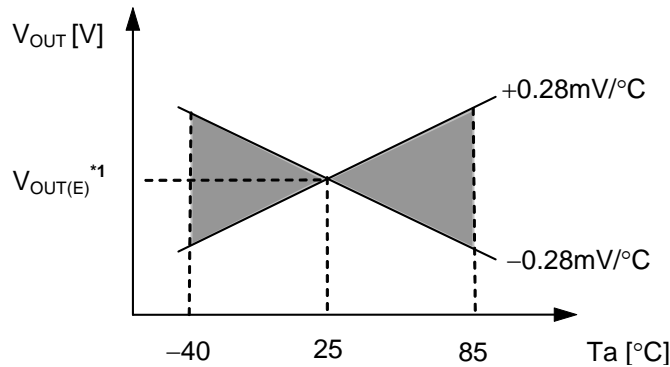

*1. The value of the output voltage measured at 25 $^{\circ}\text{C}$.

Figure 11 Temperature coefficient of output voltage (Ex. Typ. product for S-818A28A)

Temperature change ratio for output voltage [mV/ $^{\circ}\text{C}$] is calculated by using the following equation.

$$\frac{\Delta V_{OUT}}{\Delta T_a} [\text{mV}/^{\circ}\text{C}]^{*1} = V_{OUT(S)} [\text{V}]^{*2} \times \frac{\Delta V_{OUT}}{\Delta T_a \bullet V_{OUT}} [\text{ppm}/^{\circ}\text{C}]^{*3} \div 1000$$

- *1. Temperature change ratio for output voltage
- *2. Specified output voltage
- *3. Output voltage temperature coefficient

■ Operation

1. Basic Operation

Figure 12 shows the block diagram of the S-818 Series.

The error amplifier compares a reference voltage (V_{ref}) with the part of the output voltage divided by the feedback resistors R_s and R_f . It supplies the output transistor with the gate voltage, necessary to ensure certain output voltage free of any fluctuations of input voltage and temperature.

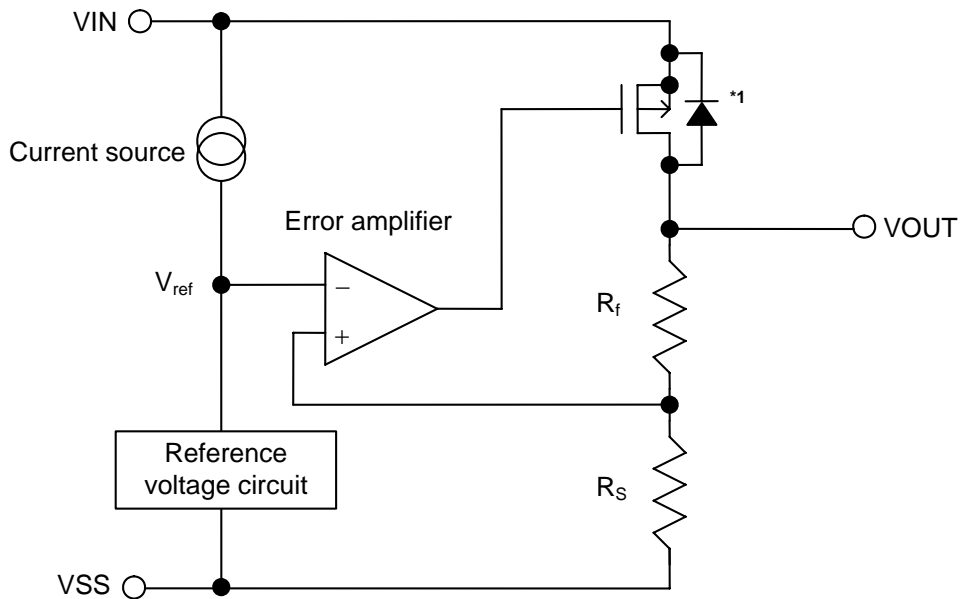

*1. Parasitic diode

Figure 12 Block diagram

2. Output Transistor

The S-818 Series uses a Pch MOS FET as the output transistor.

Be sure that V_{OUT} does not exceed $V_{IN}+0.3$ V to prevent the voltage regulator from being damaged due to inverse current flowing from VOUT pin through a parasitic diode to VIN pin.

3. ON/OFF pin (Shutdown pin)

This pin activates and inactivates the regulator.

When the ON/OFF pin is switched to the shutdown level, the operation of all internal circuit stops, the built-in Pch MOS FET output transistor between VIN and VOUT pin is switched off, suppressing current consumption. The VOUT pin goes to the Vss level due to internal divided resistance of several MΩ between VOUT pin and VSS pin.

The structure of the ON/OFF pin is shown in **Figure 13**. Since the ON/OFF pin is neither pulled down nor pulled up internally, do not keep it in the floating state. Current consumption increases if a voltage of 0.3 V to $V_{IN}-0.3$ V is applied to the ON/OFF pin. When the shutdown pin is not used, connect it to the VIN pin for product type "A" and to the VSS pin for product type "B".

Table 6 ON/OFF pin function by product type

| Product type | ON/OFF pin | Internal circuit | VOUT pin voltage | Current consumption |
|--------------|---------------|------------------|------------------|---------------------|
| A | "H": Power on | Operating | Set value | I_{SS1} |
| A | "L": Shutdown | Stop | Vss level | I_{SS2} |
| B | "H": Shutdown | Stop | Vss level | I_{SS2} |
| B | "L": Power on | Operating | Set value | I_{SS1} |

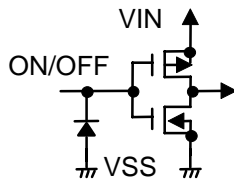

Figure 13 The structure of the ON/OFF Pin

■ Selection of Output Capacitor (C_L)

The S-818 Series needs an output capacitor between VOUT pin and VSS pin for phase compensation. A small ceramic or an OS electrolyte capacitor of 2 μF or more can be used. When a tantalum or an aluminum electrolyte capacitor is used, the capacitance must be 2 μF or more and the ESR must be 10 Ω or less.

Attention should be paid not to cause an oscillation due to increase of ESR at low temperatures when an aluminum electrolyte capacitor is used.

Evaluate the performance including temperature characteristics before prototyping the circuit.

Overshoot and undershoot characteristics differ depending upon the type of the output capacitor. Refer to the " **C_L dependence**" data in "**■ Transient Response Characteristics**".

■ **Precautions**

- Wiring patterns for the VIN pin, VOUT pin and GND pin should be designed so that the impedance is low. When mounting an output capacitor (C_L) or an input capacitor (C_{IN}), the distance from the capacitor to the VOUT pin and to the VSS pin should be as short as possible.
- Note that output voltage may increase when a voltage regulator is used at low load current (Less than 10 μ A).
- To prevent oscillation, the external components should be used under the following conditions:

| | |
|---------------------------------------|----------------------|
| Input capacitor (C_{IN}): | 0.47 μ F or more |
| Output capacitor (C_L): | 2 μ F or more |
| Equivalent series resistance (ESR): | 10 Ω or less |
| Input series resistance (R_{IN}): | 10 Ω or less |
- The voltage regulator may oscillate when the impedance of the power supply is high and the input capacitor is small or not connected.
- The application condition for input voltage and load current should not exceed the package power dissipation.
- In determining output current, attention should be paid to the output current value specified and footnote *5 in **Table 5** in the “■ **Electrical Characteristics**”.
- Do not apply an electrostatic discharge to this IC that exceeds the performance ratings of the built-in electrostatic protection circuit.
- SII claims no responsibility for any and all disputes arising out of or in connection with any infringement by products including this IC of patents owned by a third party.

■ **Characteristics (Typical data)**

1. Output Voltage (V_{OUT}) vs. Output Current (I_{OUT}) (When load current increases)

S-818A20A

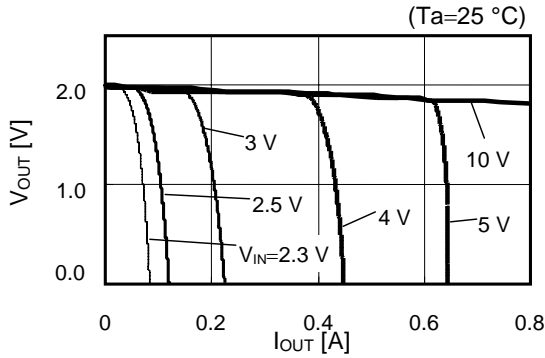

S-818A30A

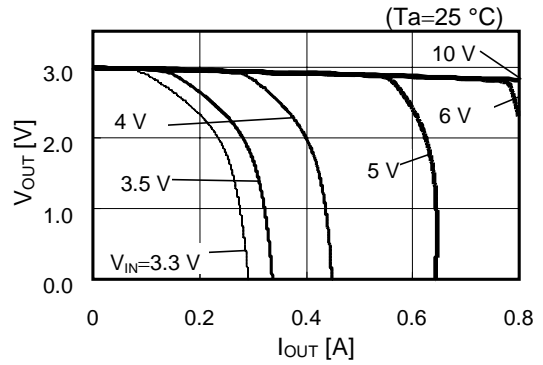

S-818A50A

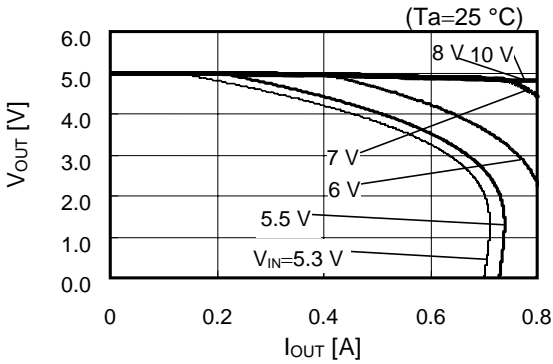

Remark In determining necessary output current, consider the following parameters:

1. Output current value in the “■ **Electrical Characteristics**” and footnote *5.
2. Power dissipation of the package

2. Output voltage (V_{OUT}) vs. Input voltage (V_{IN})

S-818A20A ($T_a=25^\circ\text{C}$)

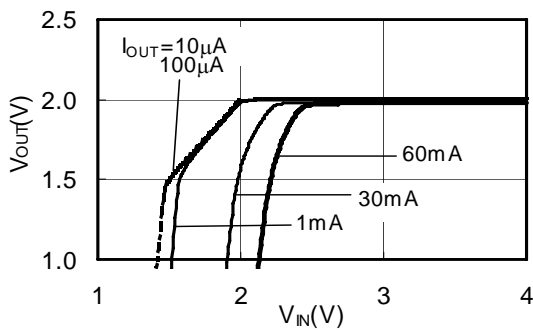

S-818A30A ($T_a=25^\circ\text{C}$)

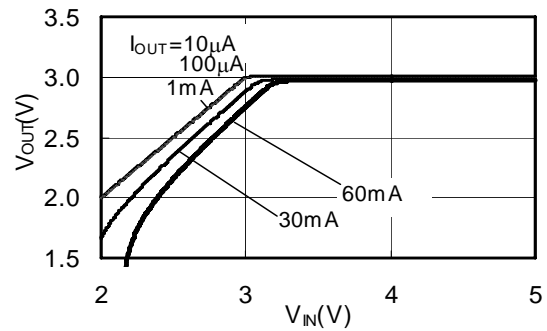

S-818A50A ($T_a=25^\circ\text{C}$)

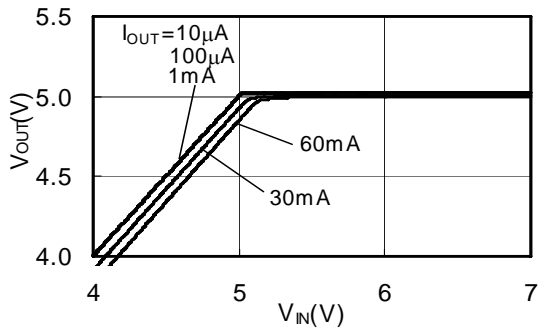

3. Maximum output current (I_{OUTmax}) vs. Input voltage (V_{IN})

S-818A20A

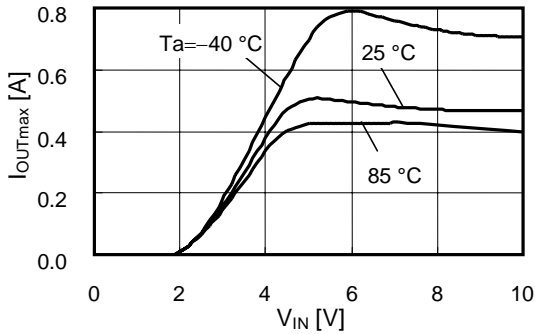

S-818A30A

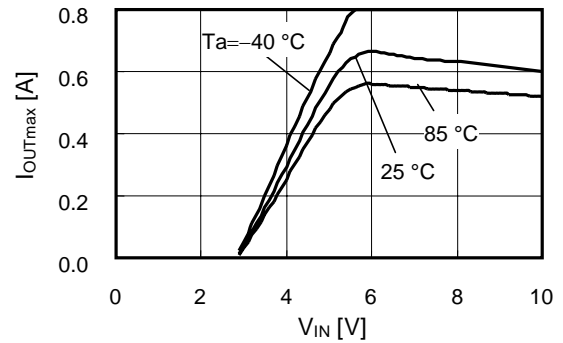

S-818A50A

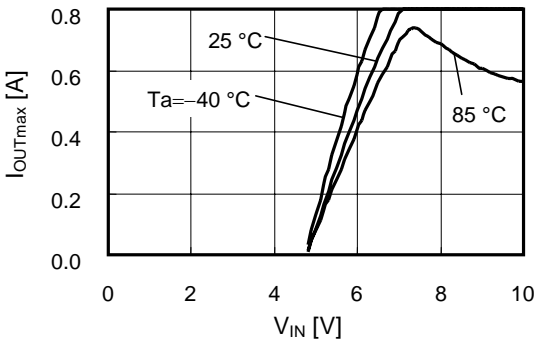

Remark In determining necessary output current, consider the following parameters:

1. Output current value in the "■ **Electrical Characteristics**" and footnote *5.
2. Power dissipation of the package

4. Dropout voltage (V_{drop}) vs. Output current (I_{OUT})

S-818A20A

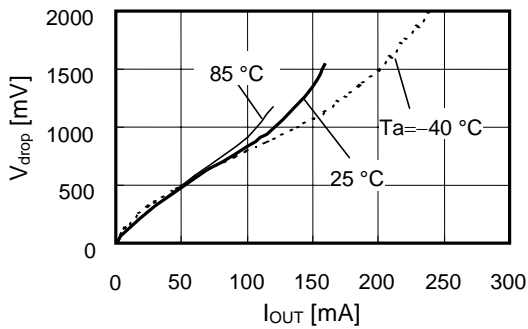

S-818A30A

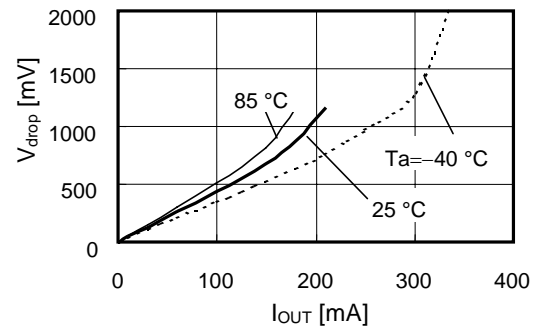

S-818A50A

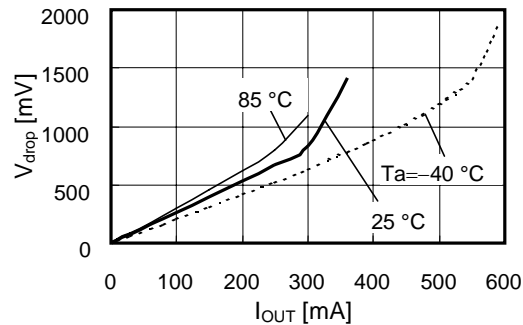

5. Output voltage (V_{OUT}) vs. Ambient temperature (T_a)

S-818A20A

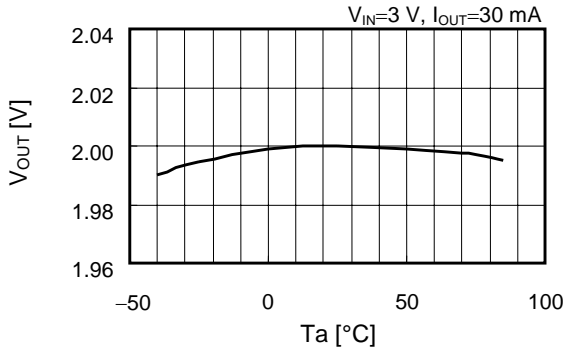

S-818A30A

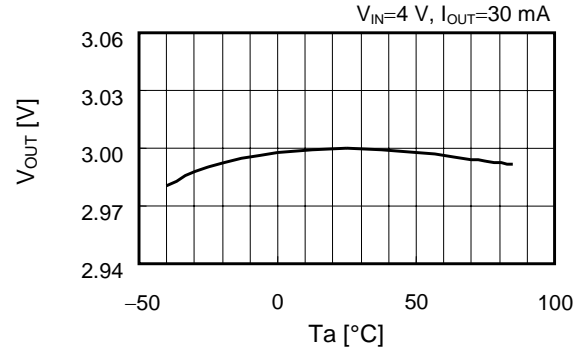

S-818A50A

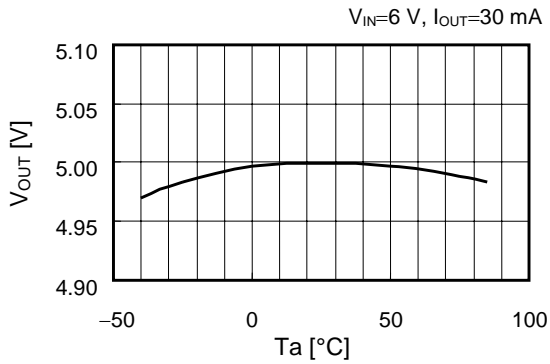

6. Line regulation (ΔV_{OUT1}) vs. Ambient temperature (T_a)

S-818A20A/S-818A30A/S-818A50A

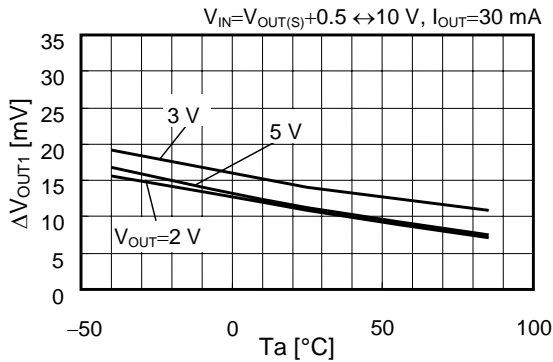

7. Load regulation (ΔV_{OUT3}) vs. Ambient temperature (T_a)

S-818A20A/S-818A30A/S-818A50A

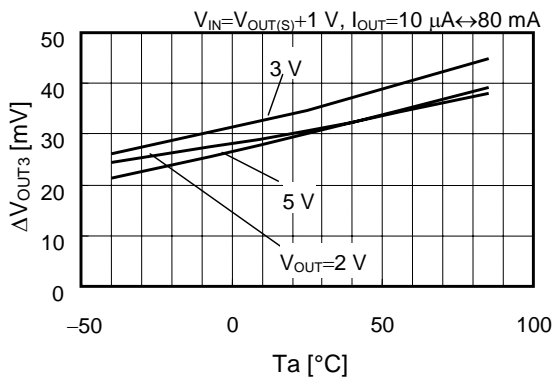

8. Current consumption (I_{SS1}) vs. Input voltage (V_{IN})

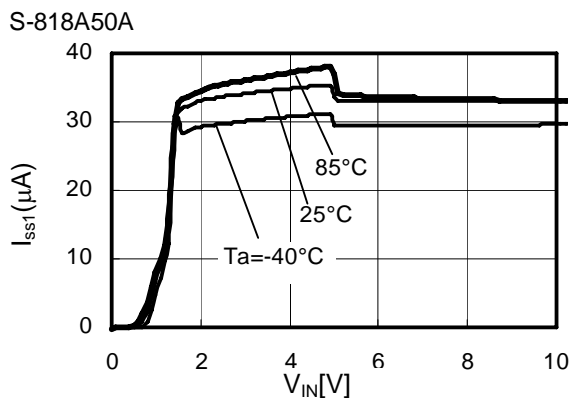
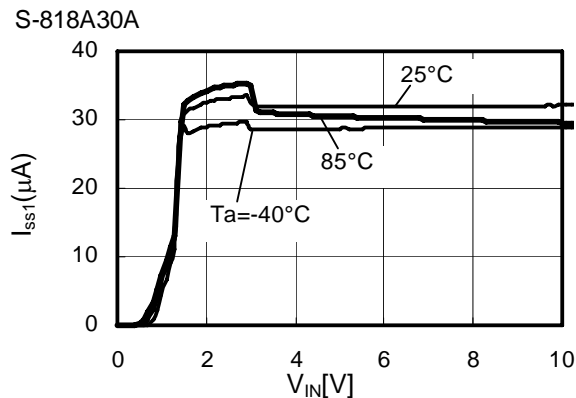
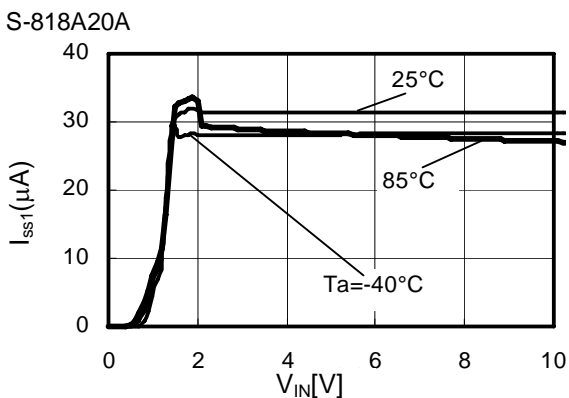

9. Threshold voltage of ON/OFF pin (V_{SH}/V_{SL}) vs. Input voltage (V_{IN})

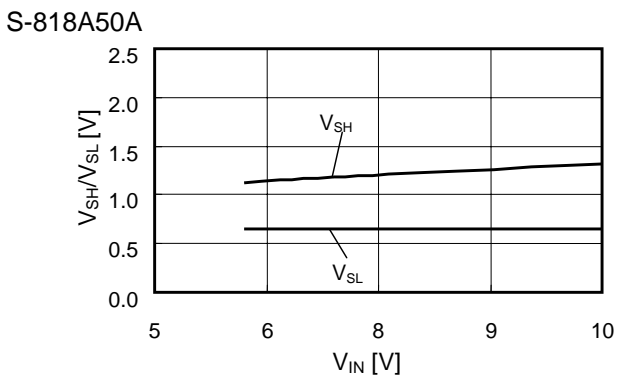
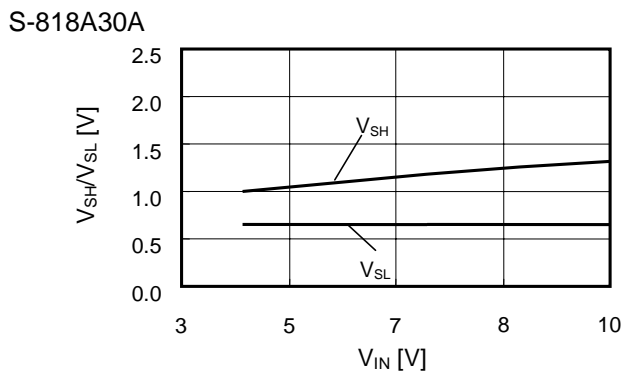
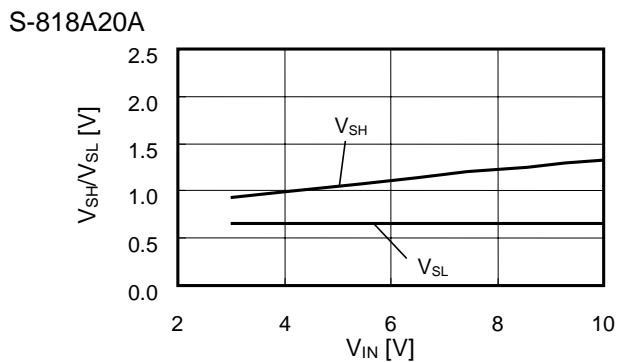

10. Ripple rejection

S-818A20A

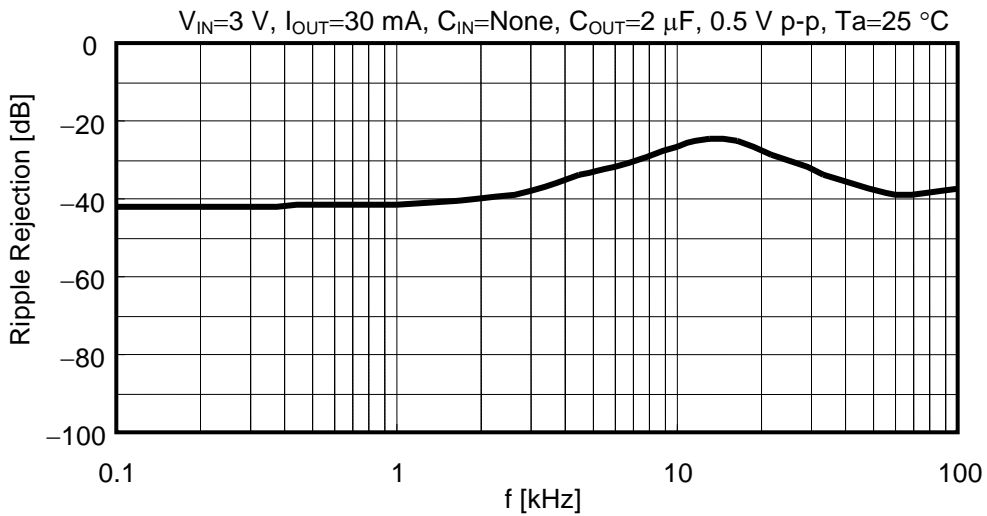

S-818A30A

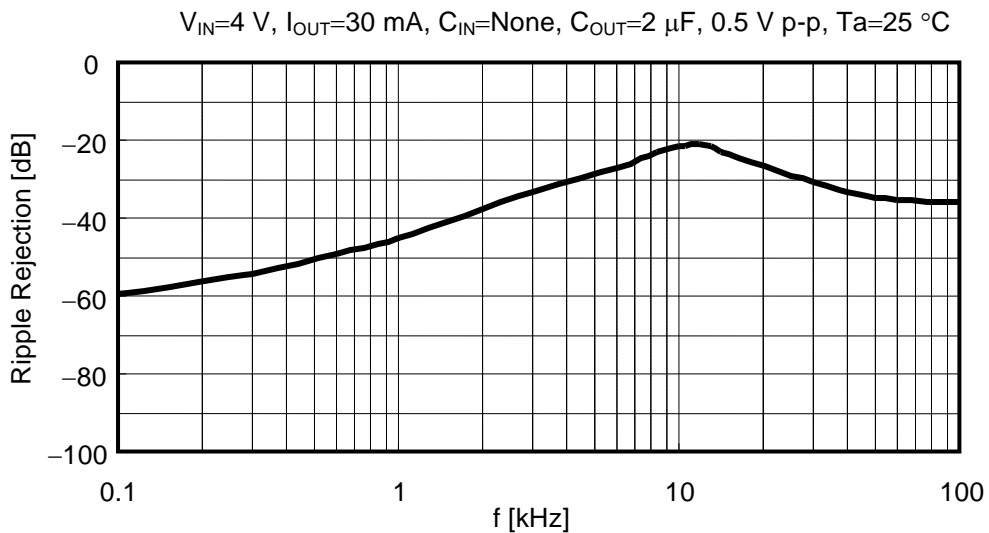

S-818A50A

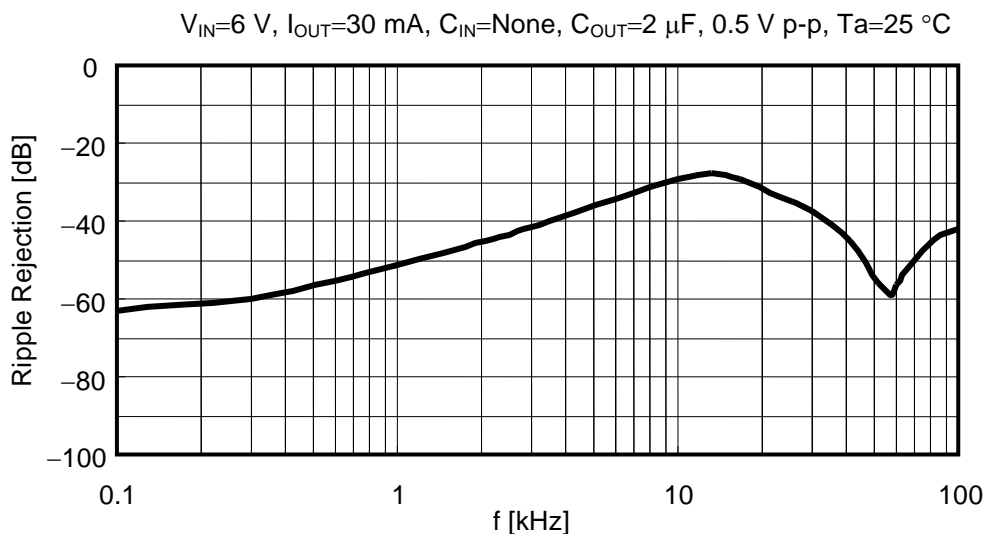

■ **Transient Response Characteristics (S-818A30A, Typical data, Ta=25°C)**

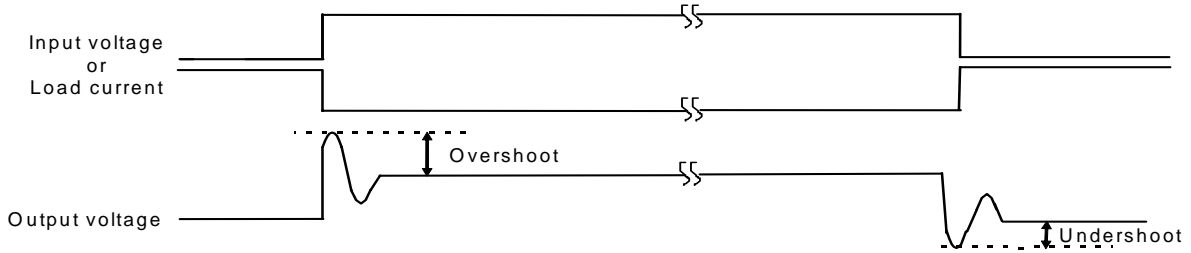

1. Power on

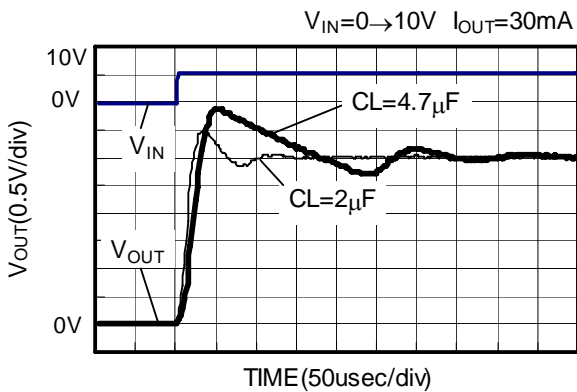

Load dependence of overshoot

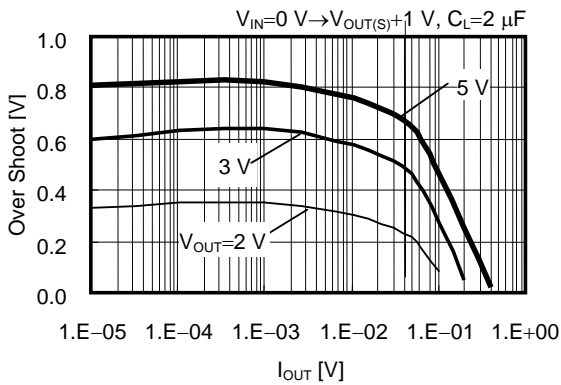

CL dependence of overshoot

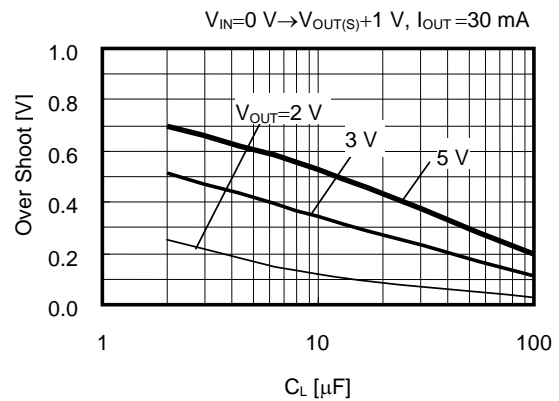

VDD dependence of overshoot

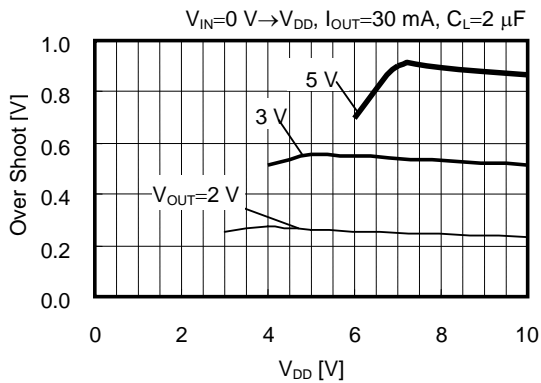

Temperature dependence of overshoot

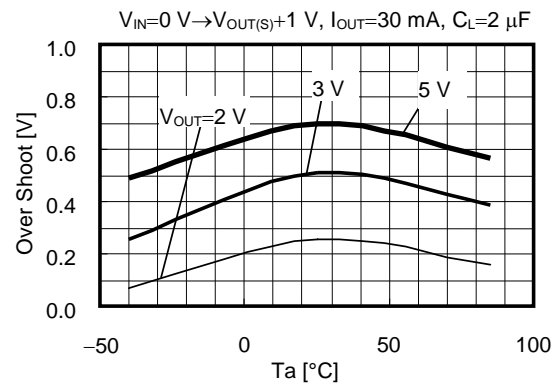

2. Shutdown control

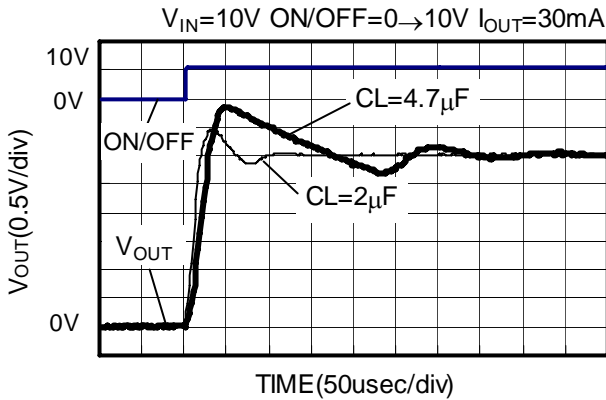

Load dependencies of overshoot

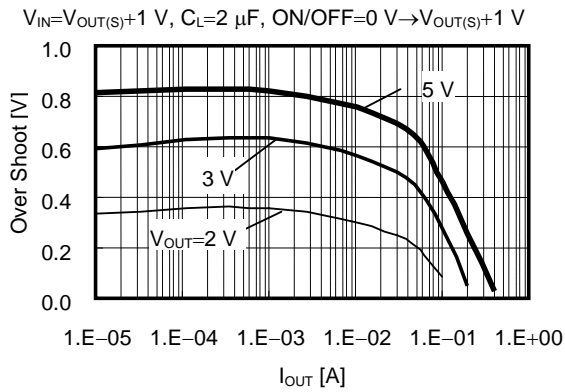

C_L dependence of overshoot

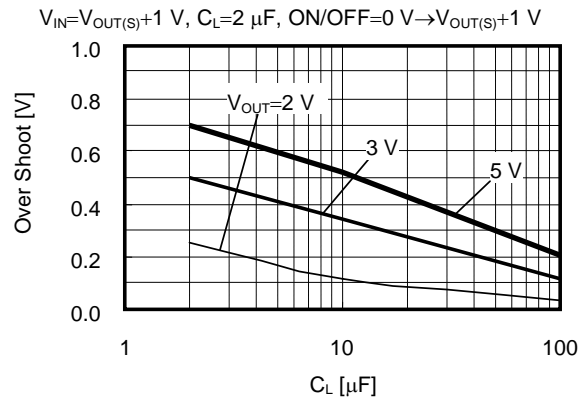

V_{DD} dependencies of overshoot

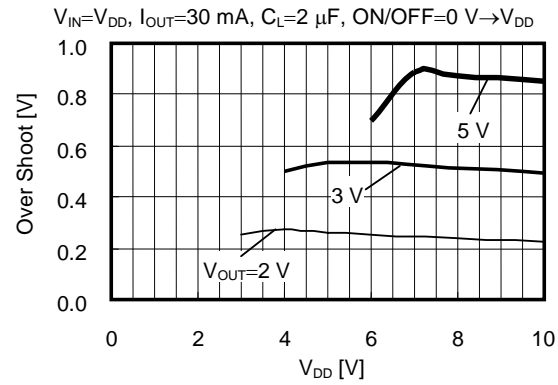

Temperature dependence of overshoot

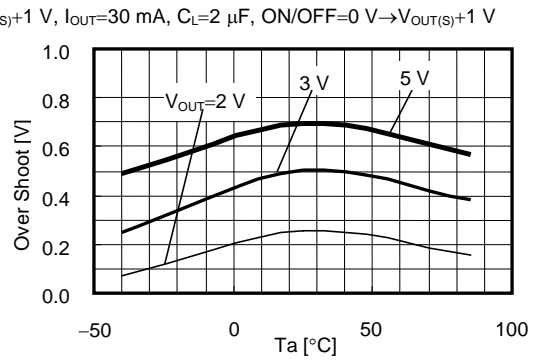

3. Power fluctuation

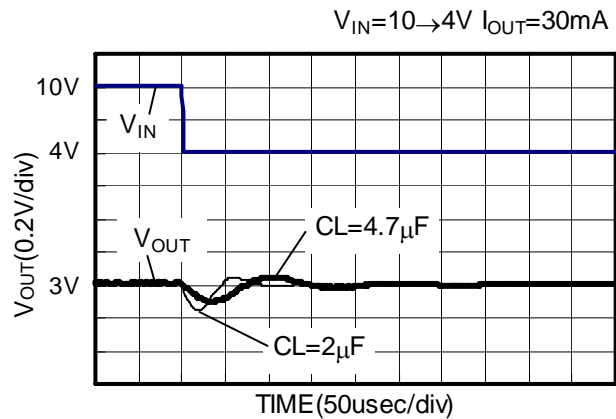
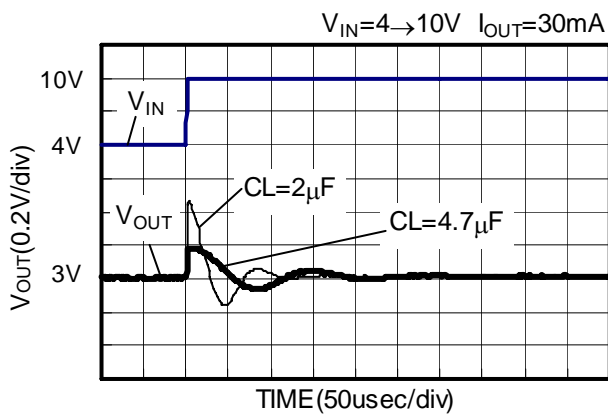

Load dependencies of overshoot

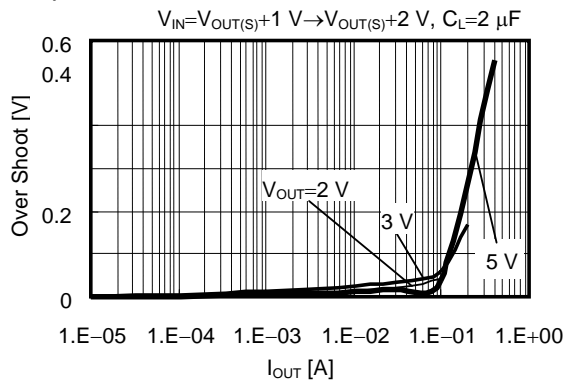

C_L dependence of overshoot

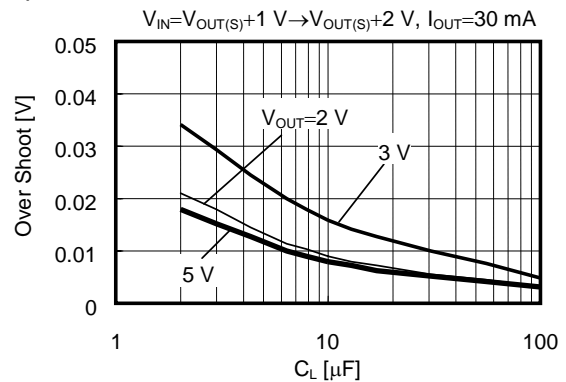

V_{DD} dependencies of overshoot

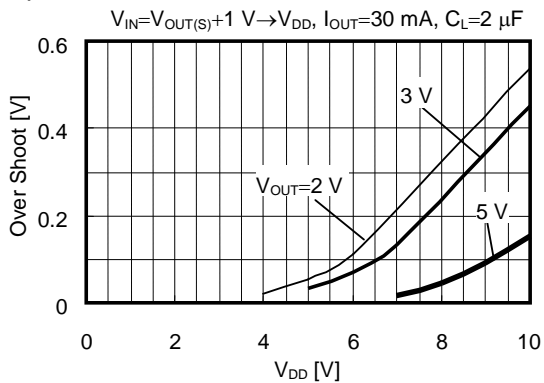

Temperature dependence

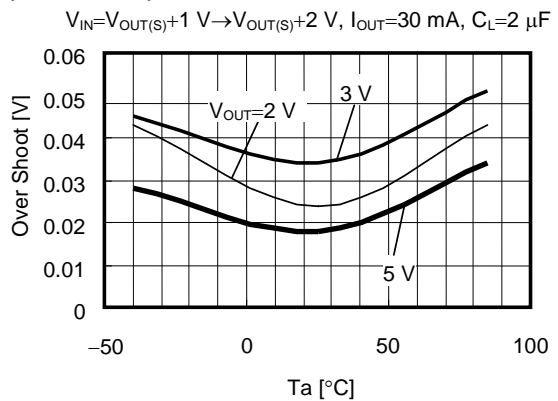

Load dependencies of undershoot

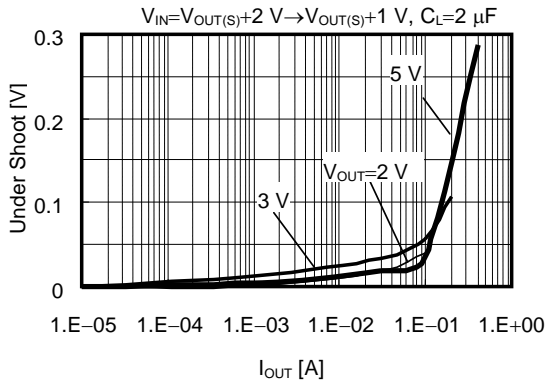

C_L dependence of undershoot

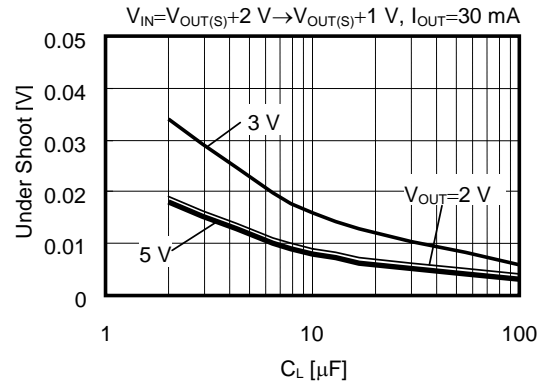

V_{DD} dependencies of undershoot

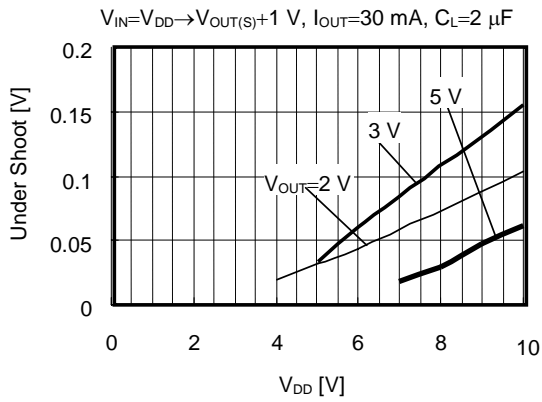

Temperature dependence of undershoot

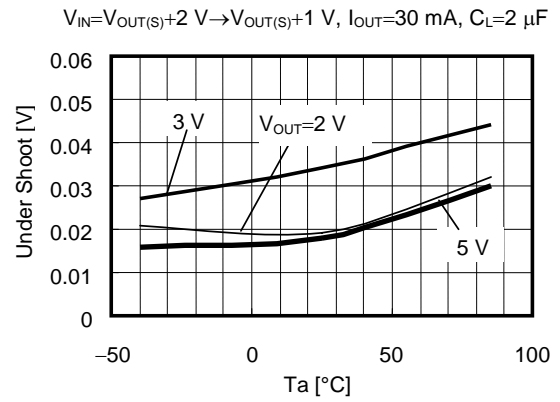

4. Load fluctuation

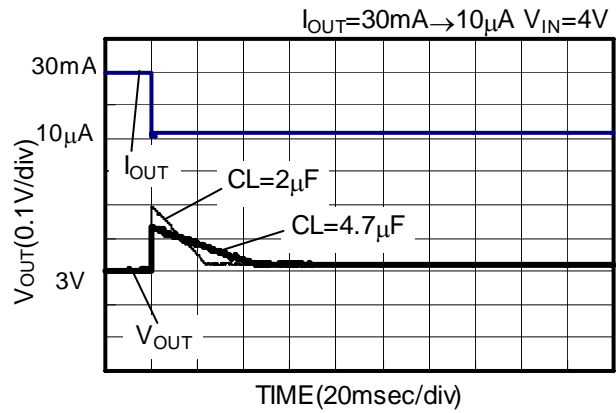
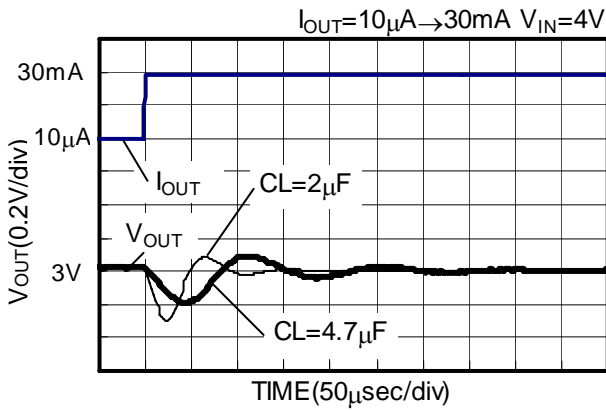

Load current dependence of load fluctuation overshoot C_L dependence of overshoot

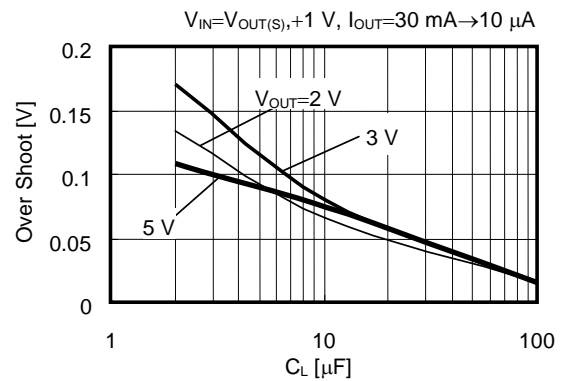
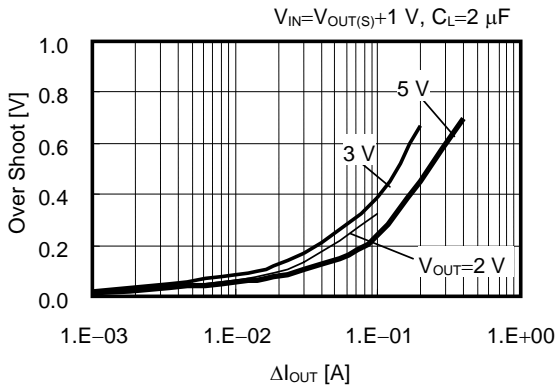

Remark ΔI_{OUT} shows larger load current at load current fluctuation while smaller current is fixed to 10 μA . For example $\Delta I_{OUT}=1.E-02$ (A) means load current fluctuation from 10 mA to 10 μA .

V_{DD} dependencies of overshoot

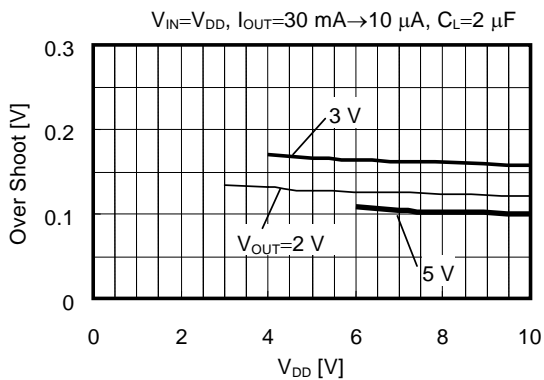

Temperature dependence of overshoot

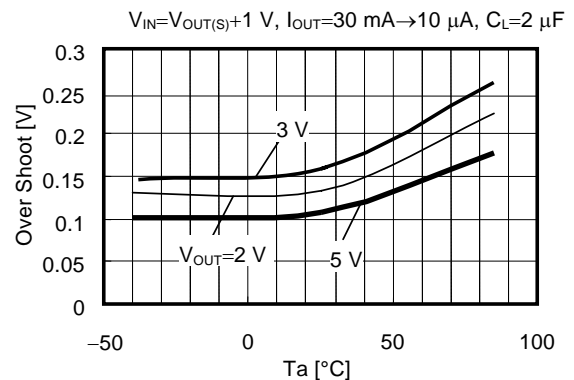

Load current dependence of load fluctuation undershoot C_L dependence of undershoot

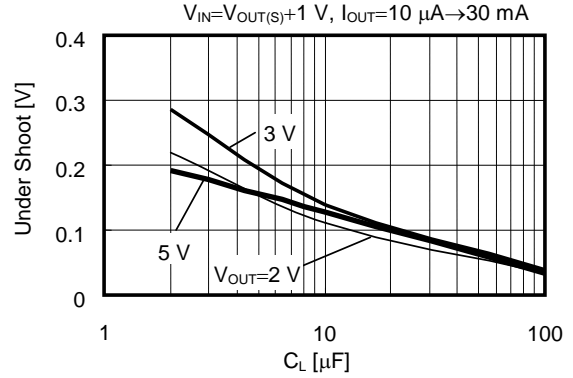
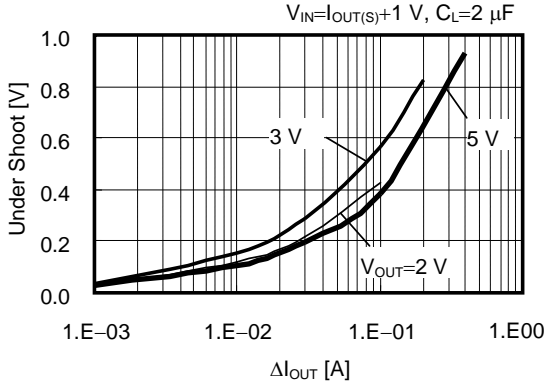

Remark ΔI_{OUT} shows larger load current at load current fluctuation while smaller current is fixed to $10 \mu A$. For example $\Delta I_{OUT}=1.E-02$ (A) means load current fluctuation from $10 \mu A$ to $10 mA$.

V_{DD} dependence of undershoot

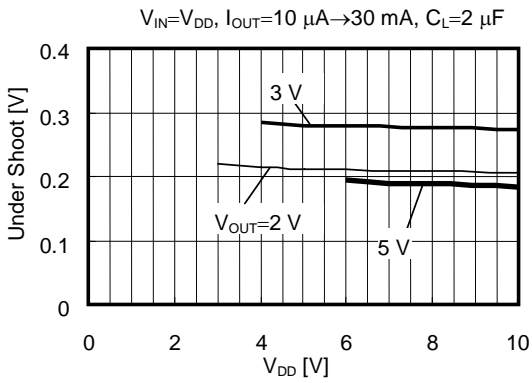

Temperature dependence of undershoot

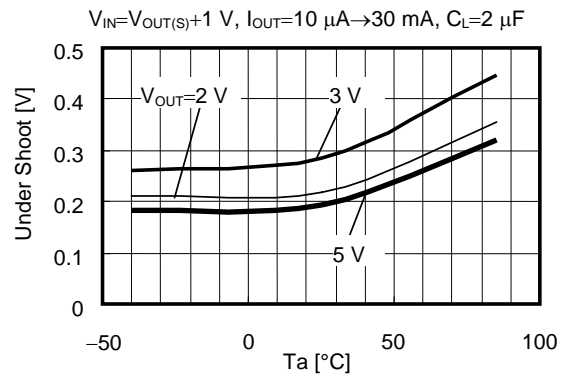

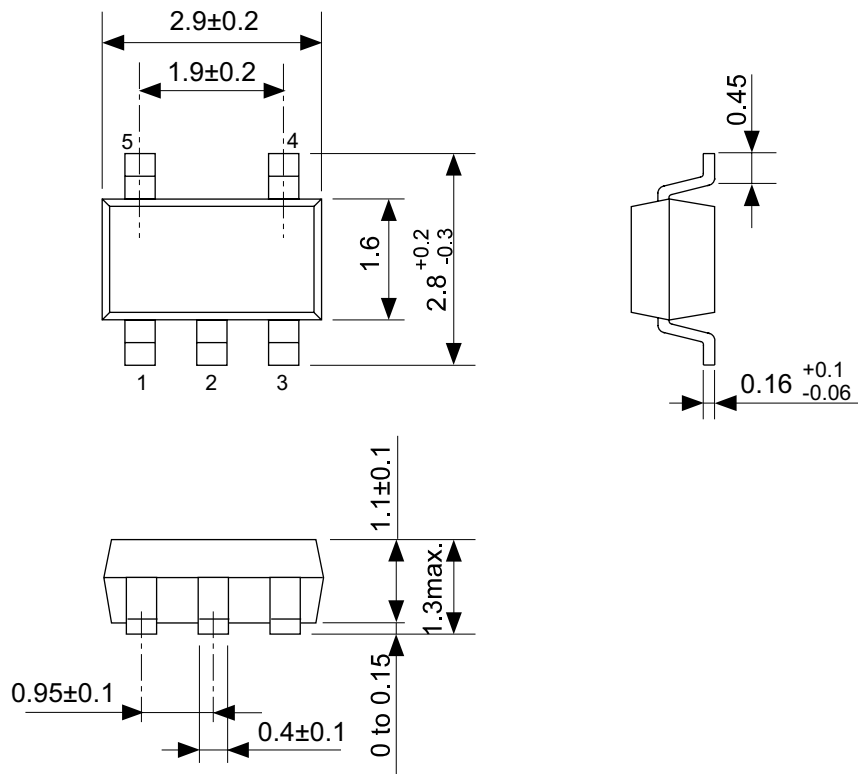

No. MP005-A-P-SD-1.2

| | |
|------------------------|-------------------------|
| TITLE | SOT235-A-PKG Dimensions |
| No. | MP005-A-P-SD-1.2 |
| SCALE | |
| UNIT | mm |
| Seiko Instruments Inc. | |

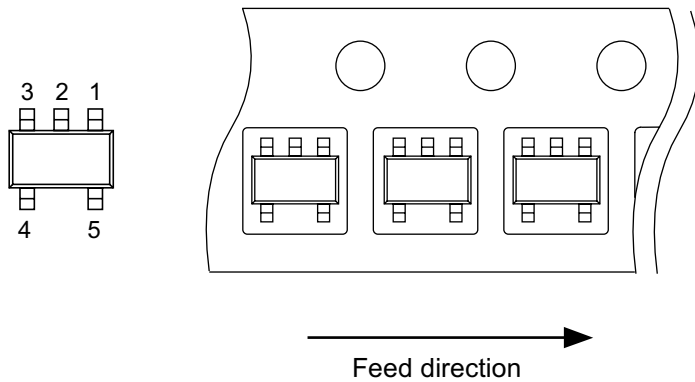
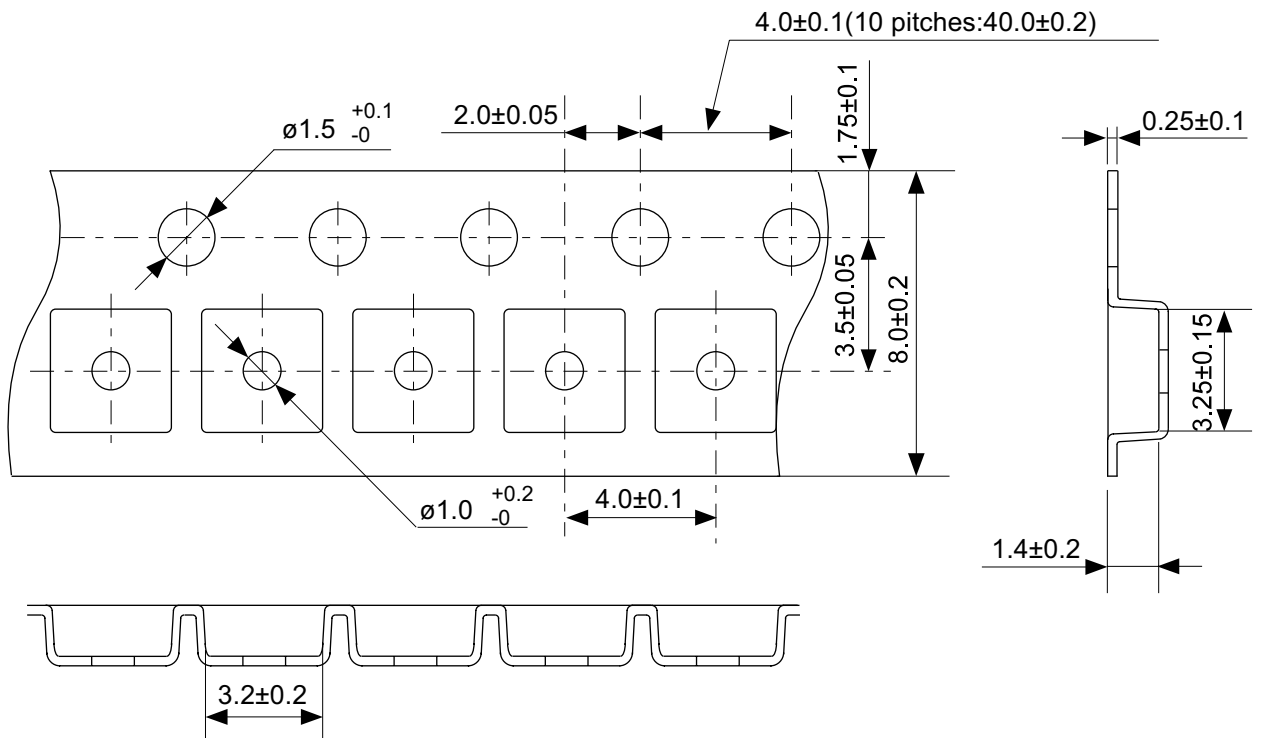

No. MP005-A-C-SD-2.1

| | |
|------------------------|-----------------------|
| TITLE | SOT235-A-Carrier Tape |
| No. | MP005-A-C-SD-2.1 |
| SCALE | |
| UNIT | mm |
| Seiko Instruments Inc. | |

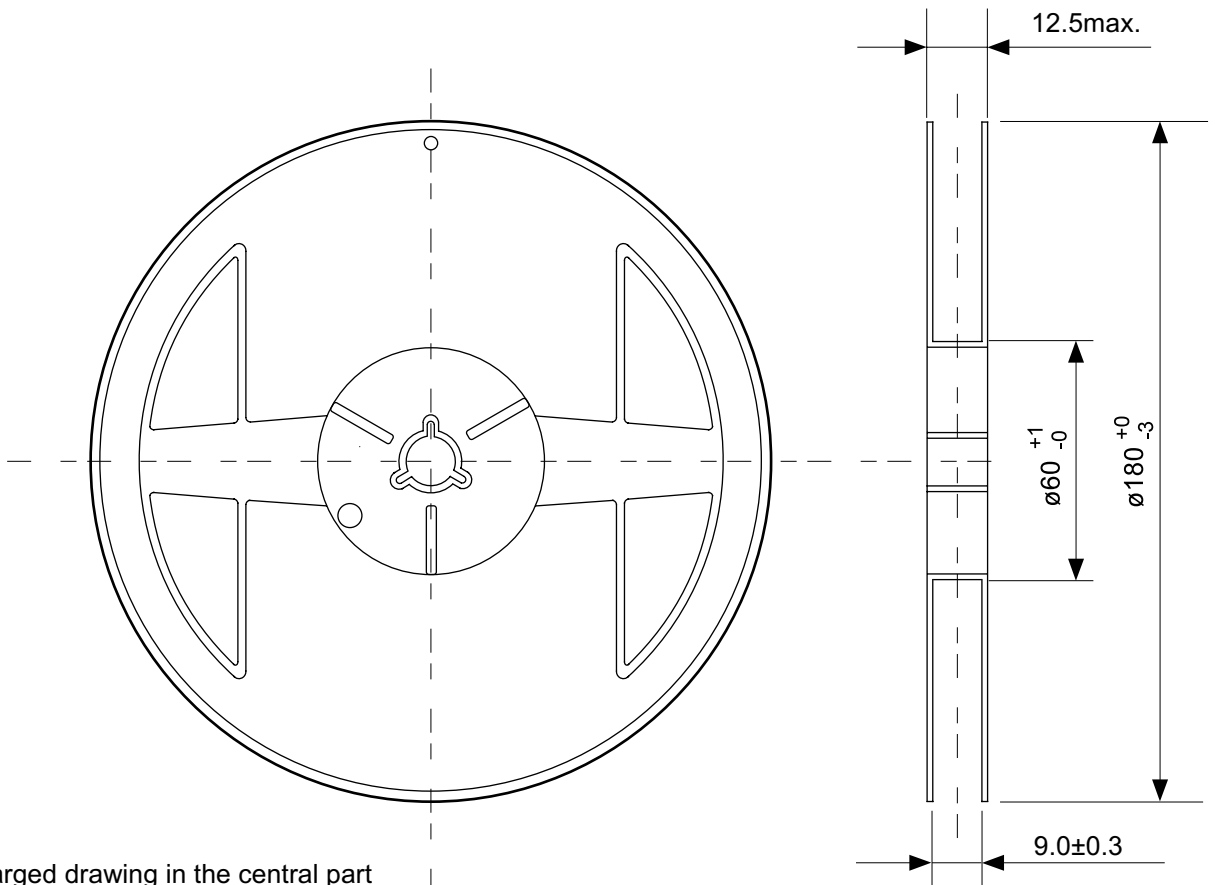

Enlarged drawing in the central part

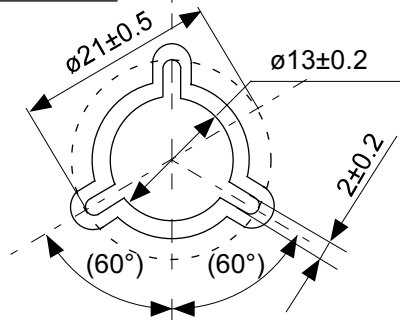

No. MP005-A-R-SD-1.1

| | | | |
|------------------------|------------------|------|-------|
| TITLE | SOT235-A-Reel | | |
| No. | MP005-A-R-SD-1.1 | | |
| SCALE | | QTY. | 3,000 |
| UNIT | mm | | |
| | | | |
| Seiko Instruments Inc. | | | |

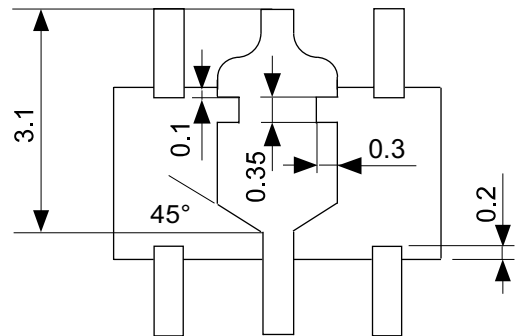
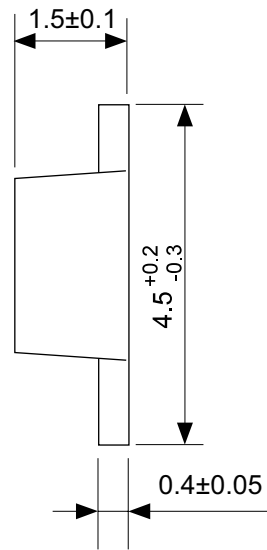
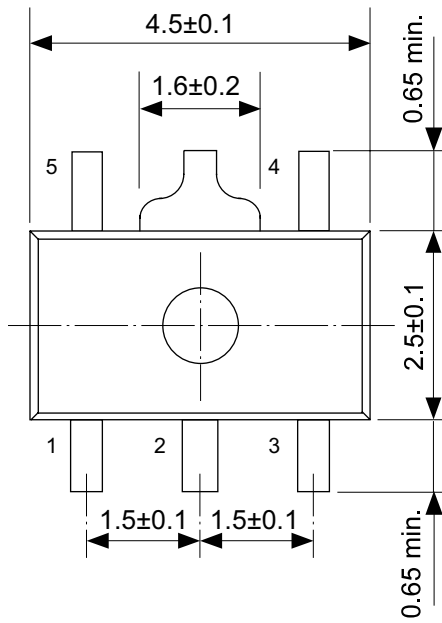

No. UP005-A-P-SD-1.1

| | |
|------------------------|-------------------------|
| TITLE | SOT895-A-PKG Dimensions |
| No. | UP005-A-P-SD-1.1 |
| SCALE | |
| UNIT | mm |
| | |
| Seiko Instruments Inc. | |

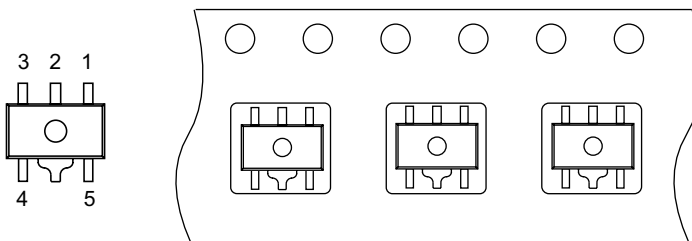
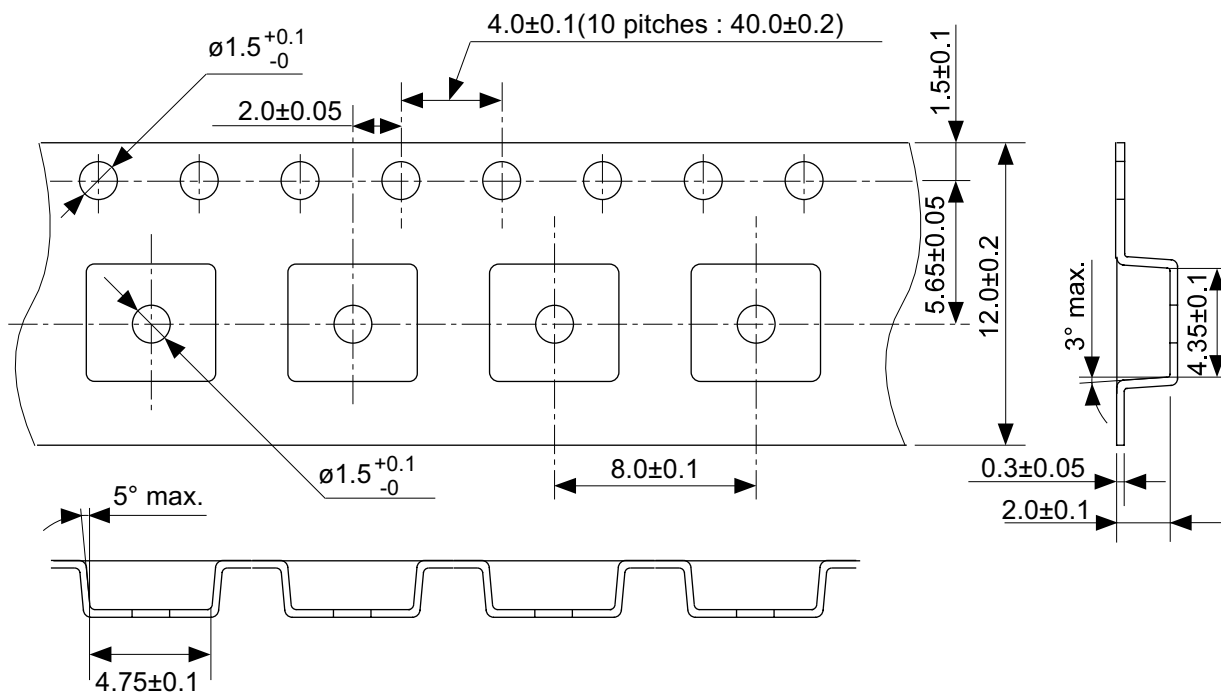

No. UP005-A-C-SD-1.1

| | |
|------------------------|-----------------------|
| TITLE | SOT895-A-Carrier Tape |
| No. | UP005-A-C-SD-1.1 |
| SCALE | |
| UNIT | mm |
| | |
| Seiko Instruments Inc. | |

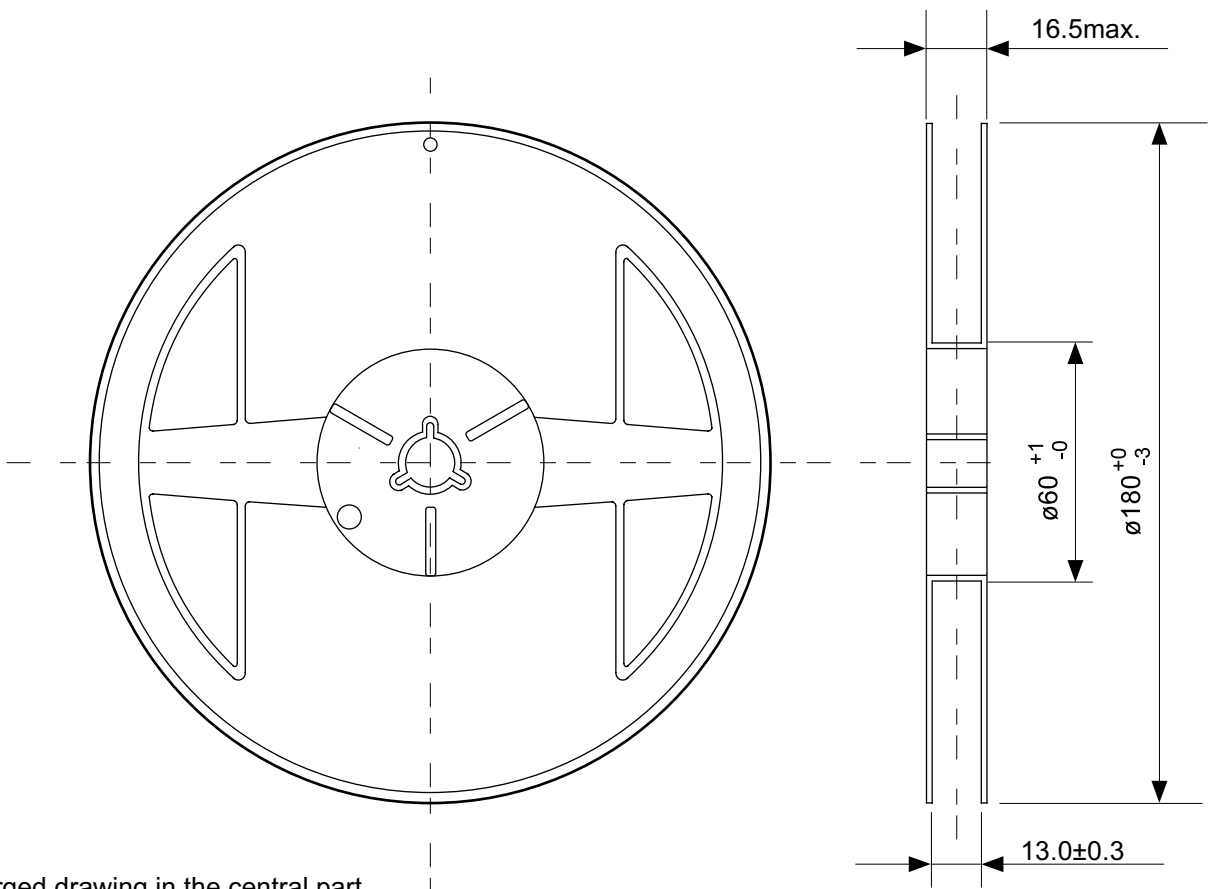

Enlarged drawing in the central part

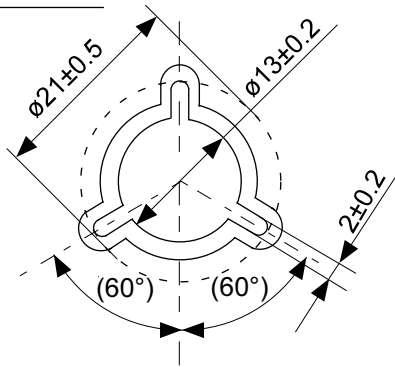

No. UP005-A-R-SD-1.1

| | | | |
|------------------------|------------------|------|-------|
| TITLE | SOT895-A-Reel | | |
| No. | UP005-A-R-SD-1.1 | | |
| SCALE | | QTY. | 1,000 |
| UNIT | mm | | |
| | | | |
| Seiko Instruments Inc. | | | |



Seiko Instruments Inc.
www.sii-ic.com

- The information described herein is subject to change without notice.
- Seiko Instruments Inc. is not responsible for any problems caused by circuits or diagrams described herein whose related industrial properties, patents, or other rights belong to third parties. The application circuit examples explain typical applications of the products, and do not guarantee the success of any specific mass-production design.
- When the products described herein are regulated products subject to the Wassenaar Arrangement or other agreements, they may not be exported without authorization from the appropriate governmental authority.
- Use of the information described herein for other purposes and/or reproduction or copying without the express permission of Seiko Instruments Inc. is strictly prohibited.
- The products described herein cannot be used as part of any device or equipment affecting the human body, such as exercise equipment, medical equipment, security systems, gas equipment, or any apparatus installed in airplanes and other vehicles, without prior written permission of Seiko Instruments Inc.
- Although Seiko Instruments Inc. exerts the greatest possible effort to ensure high quality and reliability, the failure or malfunction of semiconductor products may occur. The user of these products should therefore give thorough consideration to safety design, including redundancy, fire-prevention measures, and malfunction prevention, to prevent any accidents, fires, or community damage that may ensue.