



LD1585CXX

5 A low dropout fast response positive voltage regulator adjustable

Features

- Typical dropout 1.2 V
- Fast transient response
- Three terminal adjustable
- Guaranteed output current up to 5 A
- Output tolerance $\pm 1\%$ at 25 °C and $\pm 2\%$ in full temperature range
- Internal power and thermal limit
- Wide operating temperature range
0 °C to 125 °C
- Package available: TO-220
- Pinout compatibility with standard adjustable VREG

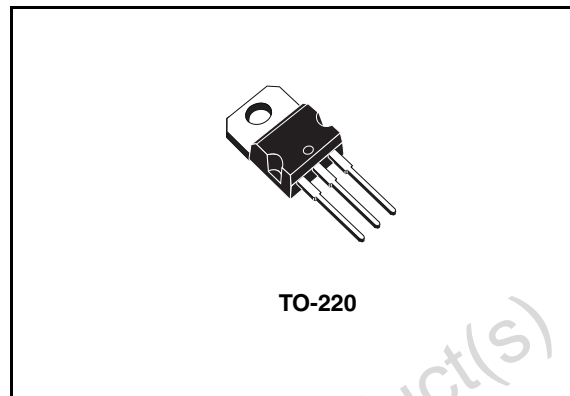

The device is supplied in TO-220. On chip trimming allows the regulator to reach a very tight output voltage tolerance, within $\pm 1\%$ at 25 °C.

Description

The LD1585C is a low drop voltage regulator able to provide up to 5 A of output current. Dropout is guaranteed at a maximum of 1.4 V at the maximum output current, decreasing at lower loads. The device has been improved to be utilized in low voltage applications where transient response and minimum input voltage are critical.

The most important features of the device consist in lower dropout voltage and very fast transient response. A 2.85 V output version is suitable for SCSI-2 active termination. Unlike PNP regulators, where a part of the output current is wasted as quiescent current, the LD1585C quiescent current flows into the load, so increase efficiency. Only a 10 μ F minimum capacitor is need for stability.

Table 1. Device summary

Part number	Order code	Output voltage
LD1585CXX	LD1585CV	ADJ

Contents

1	Diagram	3
2	Pin configuration	4
3	Maximum ratings	5
4	Typical application	6
5	Electrical characteristics	7
6	Typical characteristics	8
7	Package mechanical data	12
8	Revision history	14

1 Diagram

Figure 1. Schematic diagram

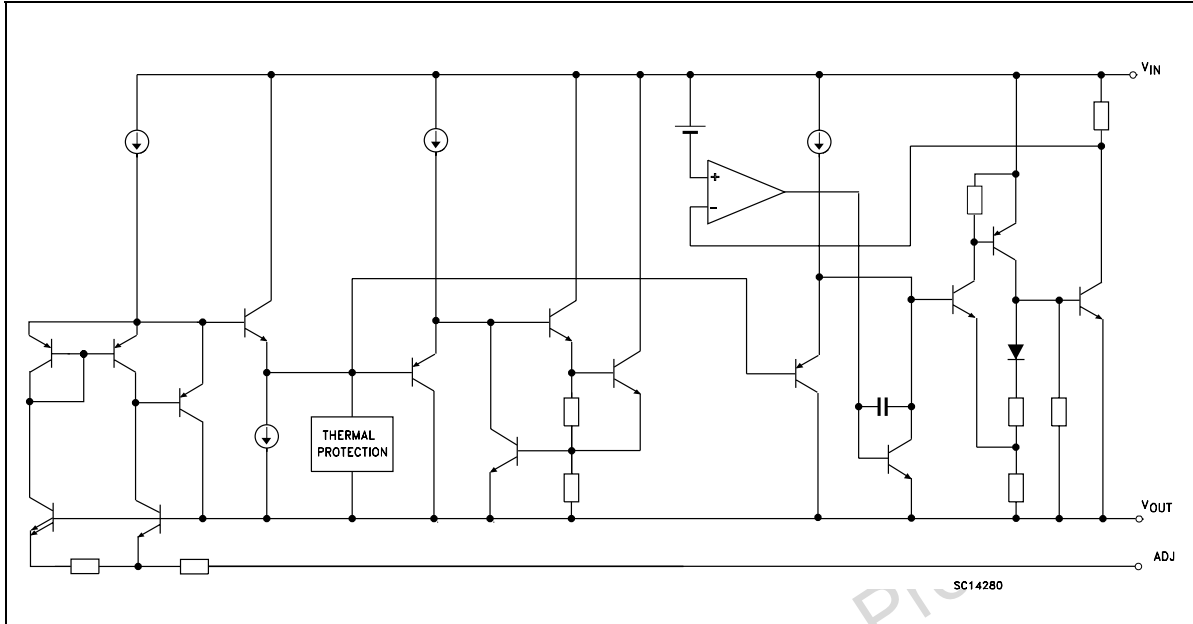

Obsolete Product(s) - Obsolete Product(s)

2 Pin configuration

Figure 2. Pin connections (top view)

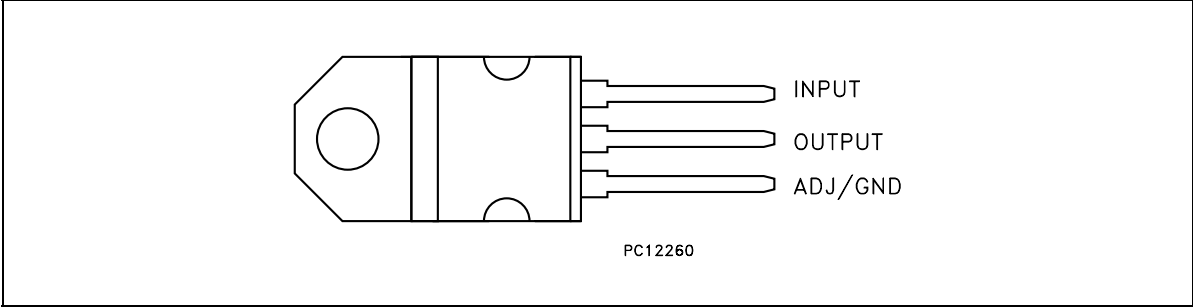

Obsolete Product(s) - Obsolete Product(s)

3 Maximum ratings

Table 2. Absolute maximum ratings

Symbol	Parameter	Value	Unit
V_I	DC input voltage	30	V
I_O	Output current	Internally limited	mA
P_D	Power dissipation	Internally limited	mW
T_{STG}	Storage temperature range	-55 to +150	°C
T_{OP}	Operating junction temperature range	0 to +125	°C

Note: Absolute maximum ratings are those values beyond which damage to the device may occur. Functional operation under these condition is not implied.

Table 3. Thermal data

Symbol	Parameter	Value	Unit
R_{thJC}	Thermal resistance junction-case	3	°C/W
R_{thJA}	Thermal resistance junction-ambient	50	°C/W

4 Typical application

Figure 3. Application circuits

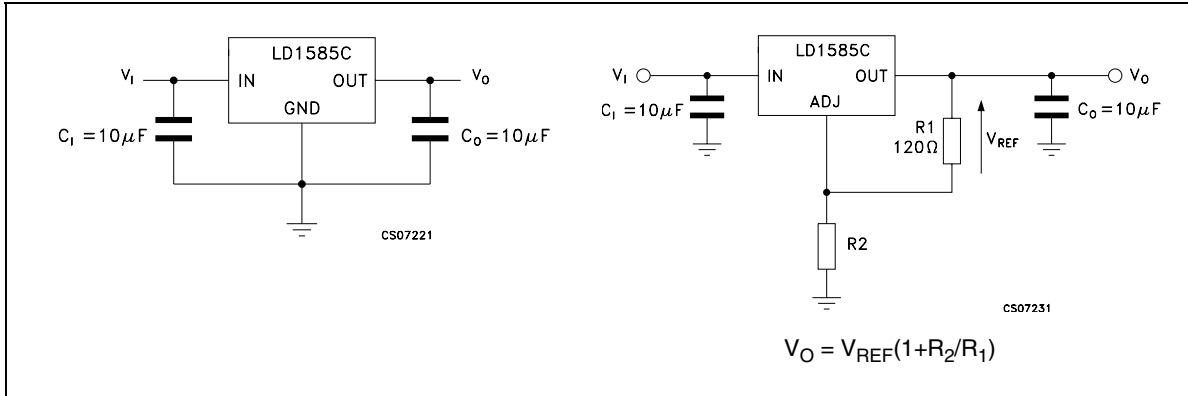

Obsolete Product(s) - Obsolete Product(s)

5 Electrical characteristics

Table 4. Electrical characteristics of LD1585C# ($V_I = 4.25\text{ V}$, $C_I = C_O = 10\ \mu\text{F}$, $T_J = 0\text{ to }125\text{ }^\circ\text{C}$, unless otherwise specified.)

Symbol	Parameter	Test conditions	Min.	Typ.	Max.	Unit
V_O	Output voltage	$I_O = 10\text{ mA}$, $V_I - V_O = 3\text{ V}$, $T_J = 25^\circ\text{C}$	1.237	1.25	1.263	V
		$I_O = 10\text{ mA to }5\text{ A}$, $V_I - V_O = 1.5\text{ to }25\text{ V}$ ⁽¹⁾	1.225	1.25	1.275	V
ΔV_O	Line regulation	$I_O = 10\text{ mA}$, $V_I = 2.75\text{ to }15\text{ V}$, $T_J = 25^\circ\text{C}$		0.015	0.2	%
		$I_O = 10\text{ mA}$, $V_I = 2.75\text{ to }15\text{ V}$		0.1	0.2	%
ΔV_O	Load regulation	$I_O = 10\text{ mA to }5\text{ A}$, $T_J = 25^\circ\text{C}$		0.1	0.3	%
		$I_O = 0\text{ to }5\text{ A}$		0.25	0.5	%
V_d	Dropout voltage	$I_O = 5\text{ A}$		1.2	1.4	V
$I_{O(\text{min})}$	Minimum load current	$V_I = 25\text{ V}$		3	10	mA
I_{sc}	Short circuit current	$V_I - V_O = 5.5\text{ V}$	5.5	7		A
	Thermal regulation	$T_J = 25^\circ\text{C}$, 30ms pulse		0.004	0.02	%/W
SVR	Supply voltage rejection	$f = 120\text{ Hz}$, $C_O = 25\ \mu\text{F}$, $C_{\text{ADJ}} = 25\ \mu\text{F}$, $I_O = 5\text{ A}$, $V_I - V_O = 3 \pm 1\text{ V}$	60	75		dB
I_{ADJ}	Adjust pin current	$I_O = 10\text{ mA}$		50	100	μA
ΔI_{ADJ}	Adjust pin current change	$I_O = 10\text{ mA to }5\text{ A}$, $V_I = 3\text{ to }25\text{ V}$ ⁽¹⁾		0.2	5	μA
eN	RMS output noise voltage (% of V_O)	$T_J = 25^\circ\text{C}$, $f = 10\text{ Hz to }10\text{ kHz}$		0.003		%
S	Temperature stability			0.5		%
S	Long term stability	$T_J = 125^\circ\text{C}$, 1000Hrs		0.5		%

1. See short-circuit current curve for available output current at fixed dropout.

6 Typical characteristics

(unless otherwise specified $T_J = 25\text{ }^\circ\text{C}$, $C_1 = C_O = 10\text{ }\mu\text{F}$ tant.)

Figure 4. Output voltage vs temperature

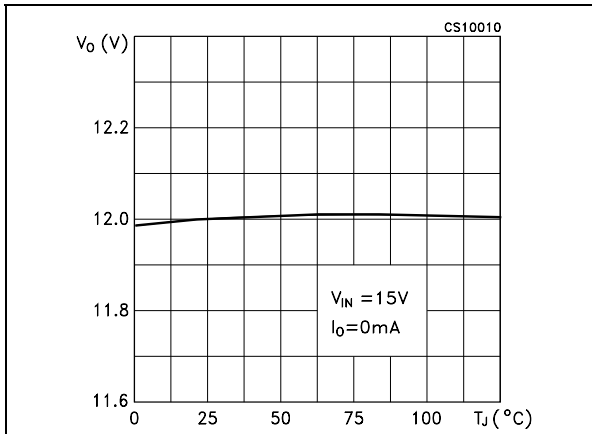

Figure 5. Short circuit current vs dropout voltage

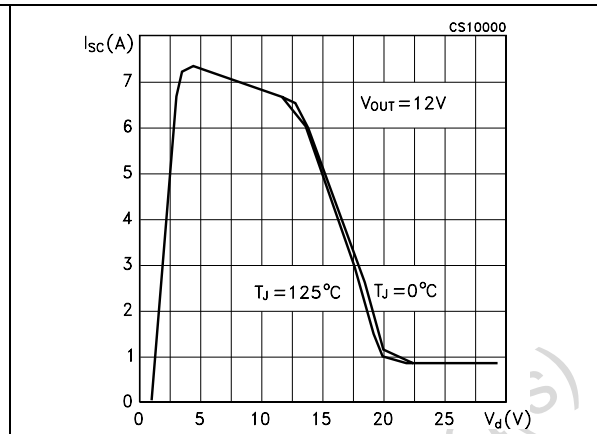

Figure 6. Line regulation vs temperature

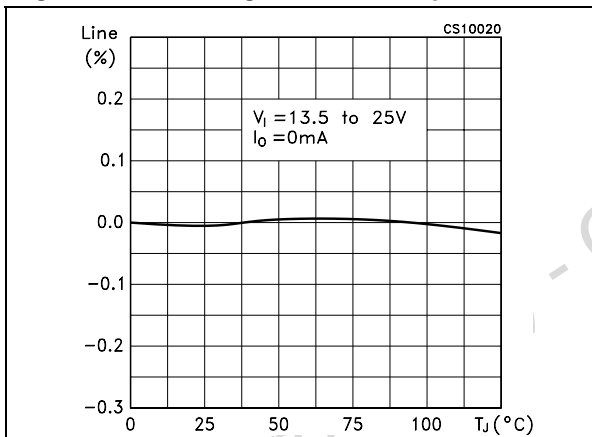

Figure 7. Line regulation vs temperature

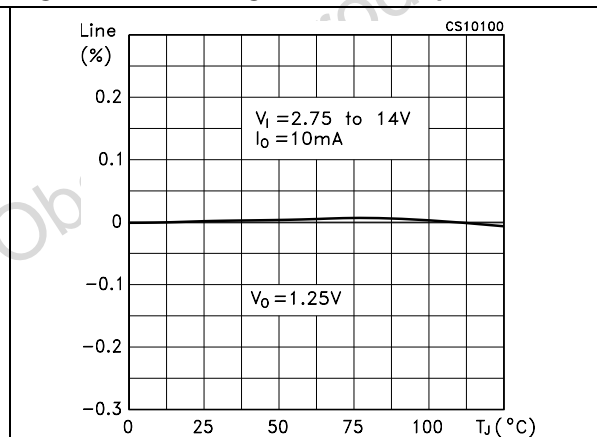

Figure 8. Load regulation vs temperature

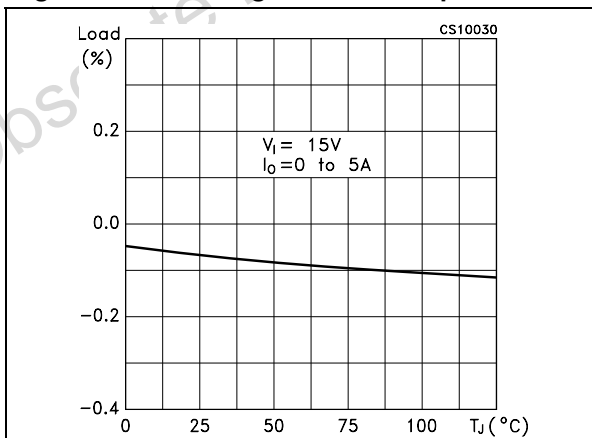

Figure 9. Load regulation vs temperature

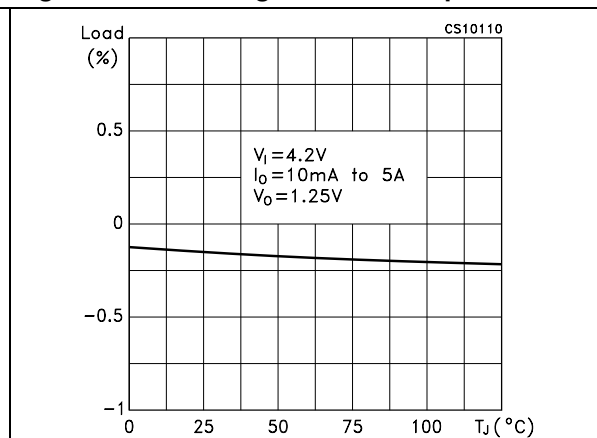

Figure 10. Dropout voltage vs temperature

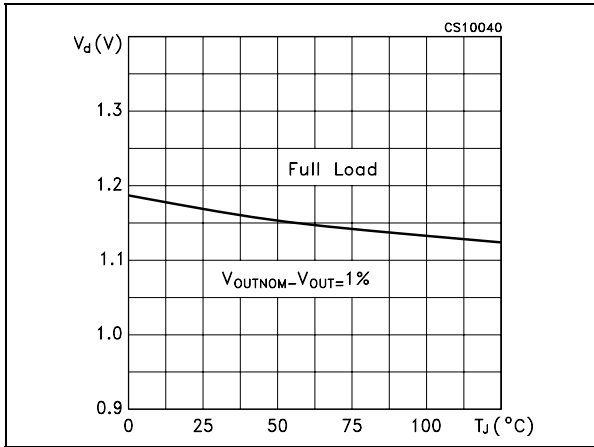

Figure 11. Dropout voltage vs output current

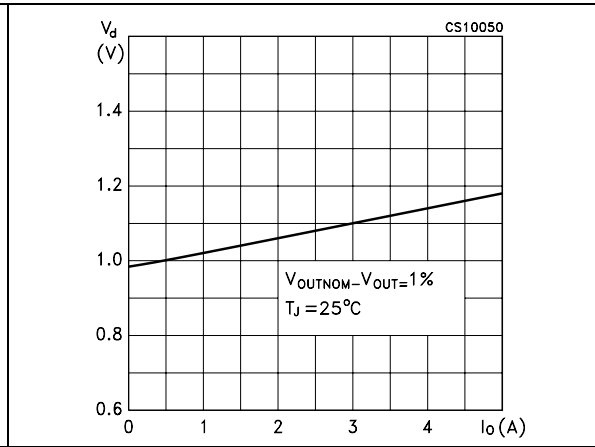

Figure 12. Adjust pin current vs input voltage

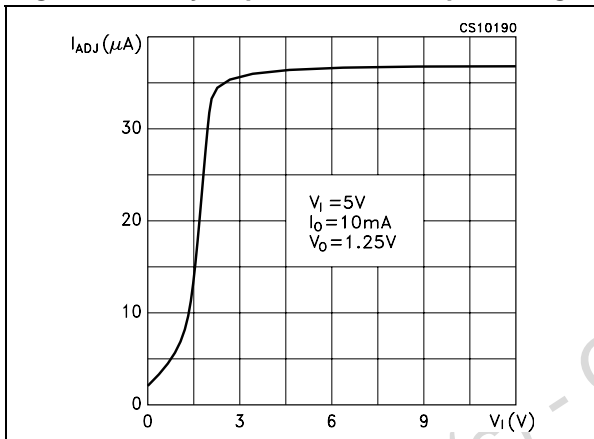

Figure 13. Adjust pin current vs temperature

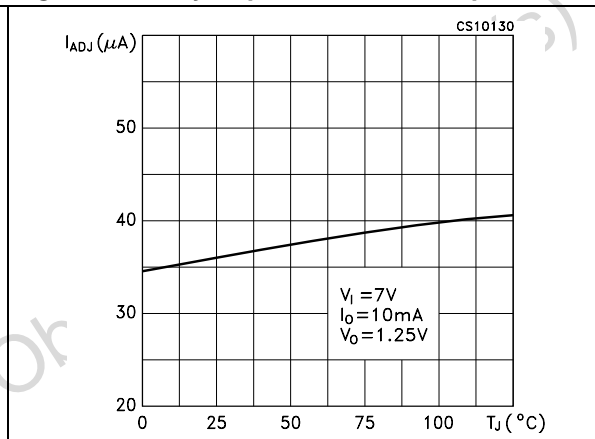

Figure 14. Adjust pin current change vs temperature

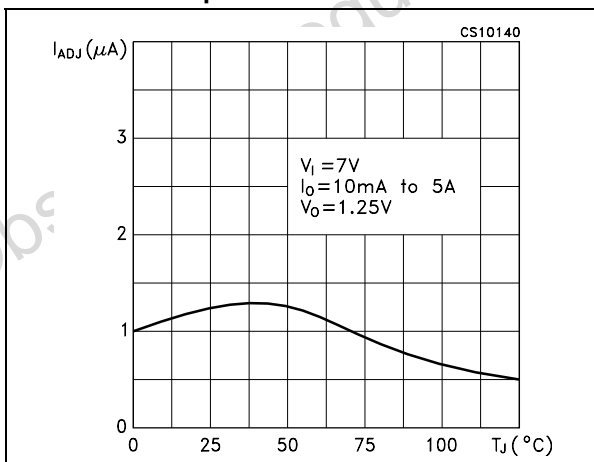

Figure 15. Quiescent current vs temperature

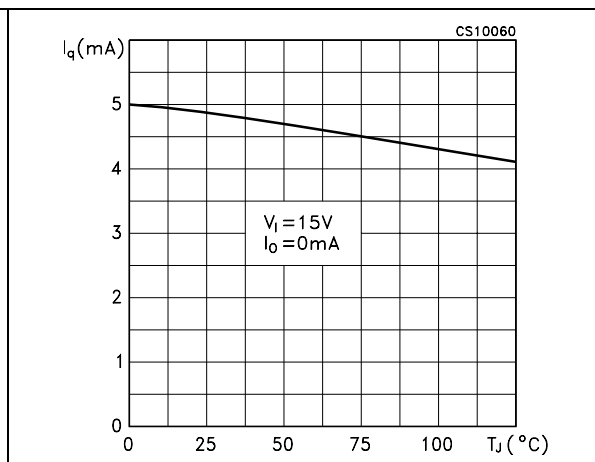

Figure 16. Reference voltage vs temperature

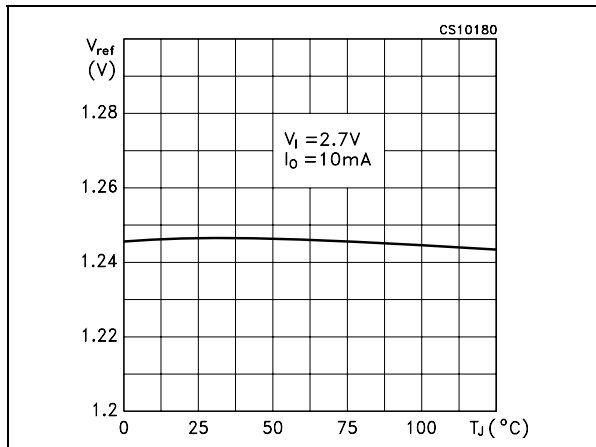

Figure 17. Minimum load current vs temperature

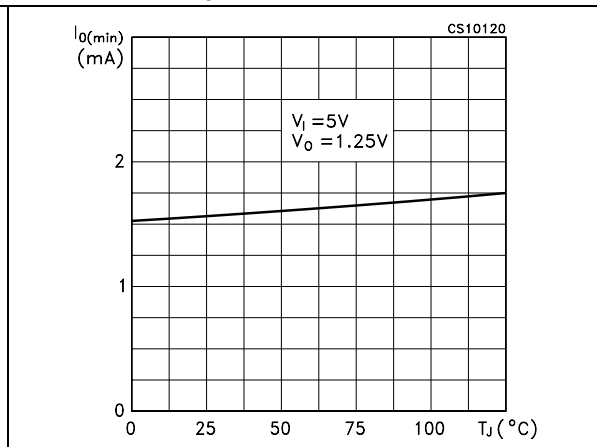

Figure 18. Supply voltage rejection vs output current

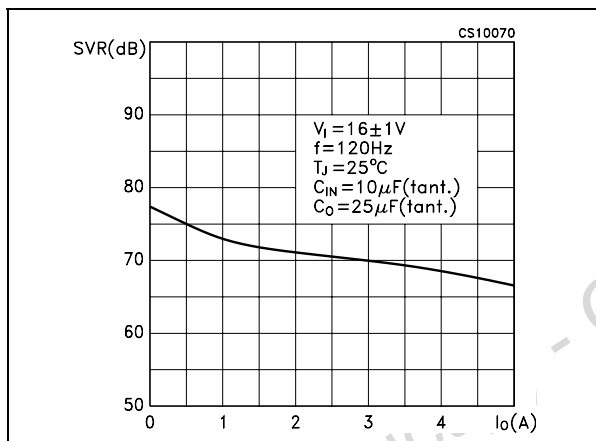

Figure 19. Supply voltage rejection vs output current

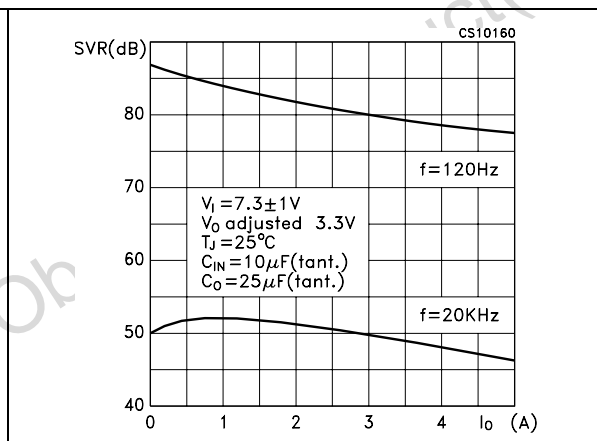

Figure 20. Supply voltage rejection vs frequency

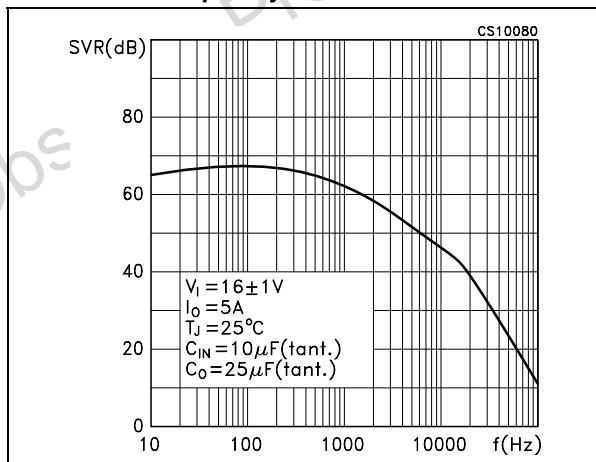

Figure 21. Supply voltage rejection vs frequency

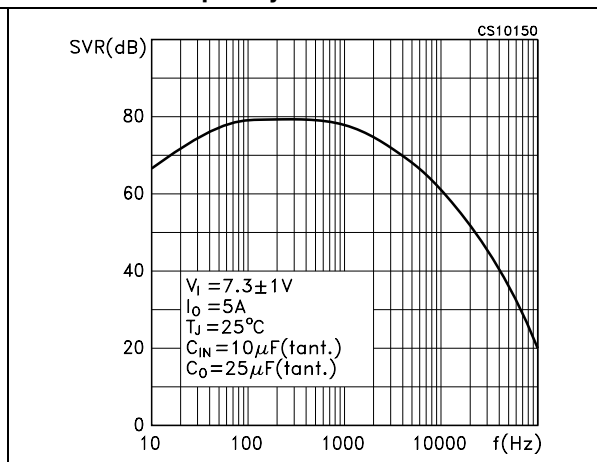

Figure 22. Supply voltage rejection vs temperature

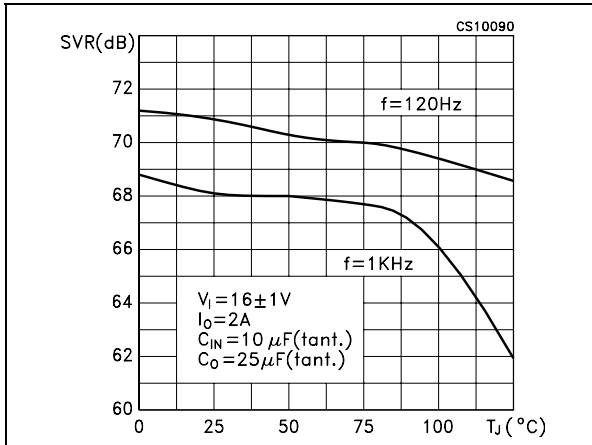

Figure 23. Supply voltage rejection vs temperature

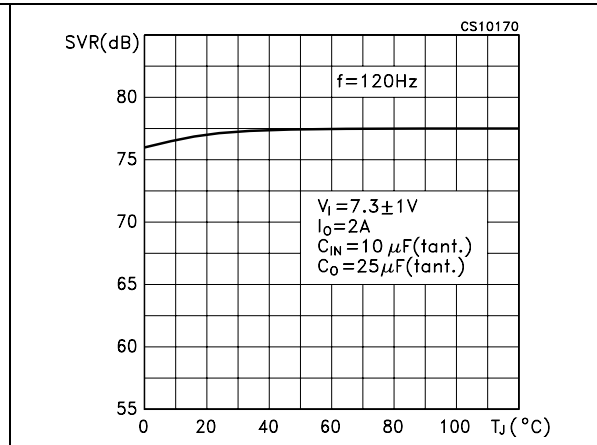

Figure 24. Line transient

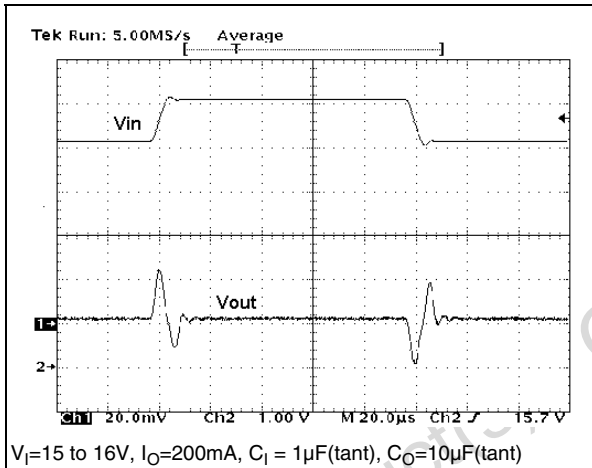

Figure 25. Load transient

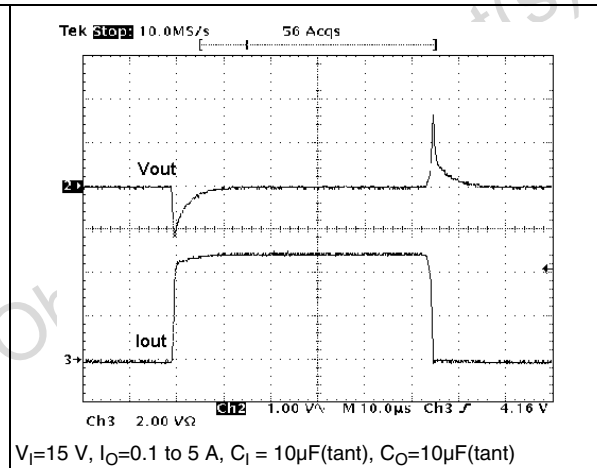
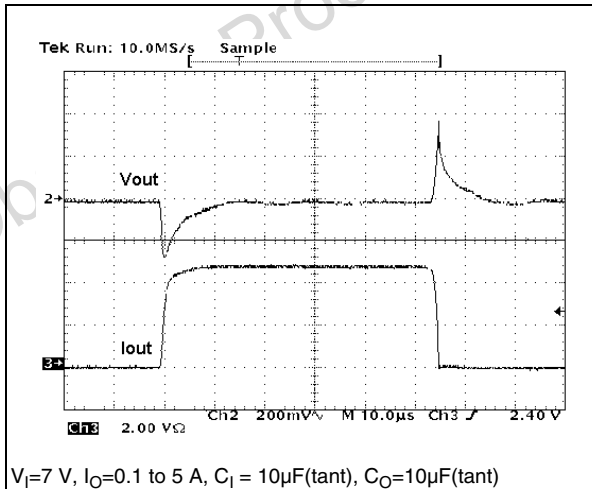

Figure 26. Load transient



7 Package mechanical data

In order to meet environmental requirements, ST offers these devices in ECOPACK[®] packages. These packages have a lead-free second level interconnect. The category of second Level Interconnect is marked on the package and on the inner box label, in compliance with JEDEC Standard JESD97. The maximum ratings related to soldering conditions are also marked on the inner box label. ECOPACK is an ST trademark. ECOPACK specifications are available at: www.st.com.

Obsolete Product(s) - Obsolete Product(s)

TO-220 mechanical data

Dim.	mm.			inch.		
	Min.	Typ.	Max.	Min.	Typ.	Max.
A	4.40		4.60	0.173		0.181
C	1.23		1.32	0.048		0.051
D	2.40		2.72	0.094		0.107
D1		1.27			0.050	
E	0.49		0.70	0.019		0.027
F	0.61		0.88	0.024		0.034
F1	1.14		1.70	0.044		0.067
F2	1.14		1.70	0.044		0.067
G	4.95		5.15	0.194		0.203
G1	2.4		2.7	0.094		0.106
H2	10.0		10.40	0.393		0.409
L2		16.4			0.645	
L4	13.0		14.0	0.511		0.551
L5	2.65		2.95	0.104		0.116
L6	15.25		15.75	0.600		0.620
L7	6.2		6.6	0.244		0.260
L9	3.5		3.93	0.137		0.154
DIA.	3.75		3.85	0.147		0.151

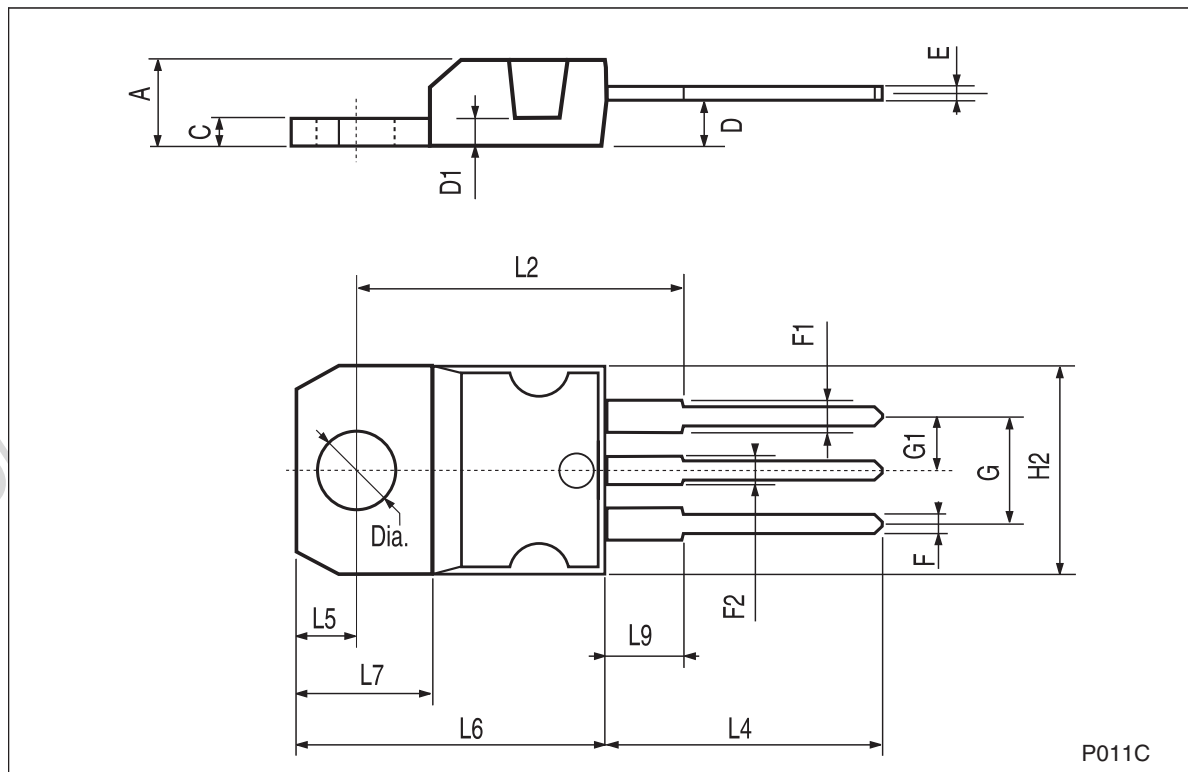

8 Revision history

Table 5. Document revision history

Date	Revision	Changes
07-Oct-2004	3	Mistake order codes - Table 1.
20-Oct-2005	4	Order codes has been updated.
08-Jun-2007	5	Order codes updated.
29-Nov-2007	6	Added Table 1 .
16-Apr-2008	7	Modified: Table 1 on page 1 .
14-Jul-2008	8	Modified: Table 1 on page 1 .

Obsolete Product(s) - Obsolete Product(s)

Please Read Carefully:

Information in this document is provided solely in connection with ST products. STMicroelectronics NV and its subsidiaries ("ST") reserve the right to make changes, corrections, modifications or improvements, to this document, and the products and services described herein at any time, without notice.

All ST products are sold pursuant to ST's terms and conditions of sale.

Purchasers are solely responsible for the choice, selection and use of the ST products and services described herein, and ST assumes no liability whatsoever relating to the choice, selection or use of the ST products and services described herein.

No license, express or implied, by estoppel or otherwise, to any intellectual property rights is granted under this document. If any part of this document refers to any third party products or services it shall not be deemed a license grant by ST for the use of such third party products or services, or any intellectual property contained therein or considered as a warranty covering the use in any manner whatsoever of such third party products or services or any intellectual property contained therein.

UNLESS OTHERWISE SET FORTH IN ST'S TERMS AND CONDITIONS OF SALE ST DISCLAIMS ANY EXPRESS OR IMPLIED WARRANTY WITH RESPECT TO THE USE AND/OR SALE OF ST PRODUCTS INCLUDING WITHOUT LIMITATION IMPLIED WARRANTIES OF MERCHANTABILITY, FITNESS FOR A PARTICULAR PURPOSE (AND THEIR EQUIVALENTS UNDER THE LAWS OF ANY JURISDICTION), OR INFRINGEMENT OF ANY PATENT, COPYRIGHT OR OTHER INTELLECTUAL PROPERTY RIGHT.

UNLESS EXPRESSLY APPROVED IN WRITING BY AN AUTHORIZED ST REPRESENTATIVE, ST PRODUCTS ARE NOT RECOMMENDED, AUTHORIZED OR WARRANTED FOR USE IN MILITARY, AIR CRAFT, SPACE, LIFE SAVING, OR LIFE SUSTAINING APPLICATIONS, NOR IN PRODUCTS OR SYSTEMS WHERE FAILURE OR MALFUNCTION MAY RESULT IN PERSONAL INJURY, DEATH, OR SEVERE PROPERTY OR ENVIRONMENTAL DAMAGE. ST PRODUCTS WHICH ARE NOT SPECIFIED AS "AUTOMOTIVE GRADE" MAY ONLY BE USED IN AUTOMOTIVE APPLICATIONS AT USER'S OWN RISK.

Resale of ST products with provisions different from the statements and/or technical features set forth in this document shall immediately void any warranty granted by ST for the ST product or service described herein and shall not create or extend in any manner whatsoever, any liability of ST.

ST and the ST logo are trademarks or registered trademarks of ST in various countries.

Information in this document supersedes and replaces all information previously supplied.

The ST logo is a registered trademark of STMicroelectronics. All other names are the property of their respective owners.

© 2008 STMicroelectronics - All rights reserved

STMicroelectronics group of companies

Australia - Belgium - Brazil - Canada - China - Czech Republic - Finland - France - Germany - Hong Kong - India - Israel - Italy - Japan - Malaysia - Malta - Morocco - Singapore - Spain - Sweden - Switzerland - United Kingdom - United States of America

www.st.com