



1.425V to 3.6V Input, 1A Low-Dropout Regulators with BIAS Input

MAX15027/MAX15028

General Description

The MAX15027/MAX15028 low-dropout linear regulators operate from input voltages as low as 1.425V and deliver up to 1A of continuous output current with a typical dropout voltage of only 75mV. The output voltage is adjustable from 0.5V to V_{IN} and is $\pm 2\%$ accurate over load and line variations, from -40°C to $+125^{\circ}\text{C}$. The MAX15028 features a BIAS input of 3V to 5.5V from an always-on power supply. The BIAS input current is reduced down to less than $2\mu\text{A}$ during shutdown.

These regulators use small, $1\mu\text{F}$ ceramic input capacitors and $4.7\mu\text{F}$ ceramic output capacitors to deliver 1A output current. High bandwidth provides excellent transient response and limits the output voltage deviation to 15mV for a 500mA load step, with only a $4.7\mu\text{F}$ ceramic output capacitor, and the voltage deviations can be reduced further by increasing the output capacitor.

These devices offer a logic-controlled shutdown input to reduce input current (I_{IN}) consumption down to less than $5.5\mu\text{A}$ in standby mode. Other features include a soft-start to reduce inrush current, short-circuit protection, and thermal-overload protection.

The MAX15028 features a BIAS input allowing a secondary supply to keep the LDO's internal circuitry alive if the voltage on IN goes to 0V. Both devices are fully specified from -40°C to $+125^{\circ}\text{C}$ and are available in a 10-pin thermally enhanced TDFN package (3mm x 3mm) that includes an exposed pad for optimal power dissipation. For a 500mA version of these LDOs, refer to the MAX15029/MAX15030 data sheet.

Applications

Automotive (Dead-Man LDO)
Servers
Storage
Networking
Base Stations
Optical Modules
ATE

Typical Operating Circuits appear at end of data sheet.

Features

- ◆ 1.425V to 3.6V Input Voltage Range
- ◆ Output Voltage Programmable from 0.5V to V_{IN}
- ◆ Guaranteed Maximum 225mV Dropout at 1A Output Current
- ◆ $\pm 2\%$ Output Accuracy Over Load, Line, and Temperature
- ◆ Stable with Ceramic Capacitors
- ◆ Fast Transient Response
- ◆ $60\mu\text{A}$ Operating Bias Supply Current (MAX15028)
- ◆ $1.2\mu\text{A}$ Shutdown Bias Supply Current (MAX15028)
- ◆ Short-Circuit and Thermal Protection
- ◆ -40°C to $+125^{\circ}\text{C}$ Operating Temperature Range
- ◆ Soft-Start Limits Inrush Current
- ◆ Thermally Enhanced 3mm x 3mm TDFN Package
- ◆ AEC-Q100 Qualified

Ordering Information

PART	TEMP RANGE	PIN-PACKAGE	TOP MARK
MAX15027ATB+T	-40°C to $+125^{\circ}\text{C}$	10 TDFN-EP*	+AUD
MAX15027ATB/V+T	-40°C to $+125^{\circ}\text{C}$	10 TDFN-EP*	+AWC
MAX15028ATB+T	-40°C to $+125^{\circ}\text{C}$	10 TDFN-EP*	+AUE

+ Denotes a lead(Pb)-free/RoHS-compliant package.

For tape-and-reel orders, add a "T" after the "+".

*EP = Exposed pad.

V denotes an automotive qualified part.

Pin Configurations

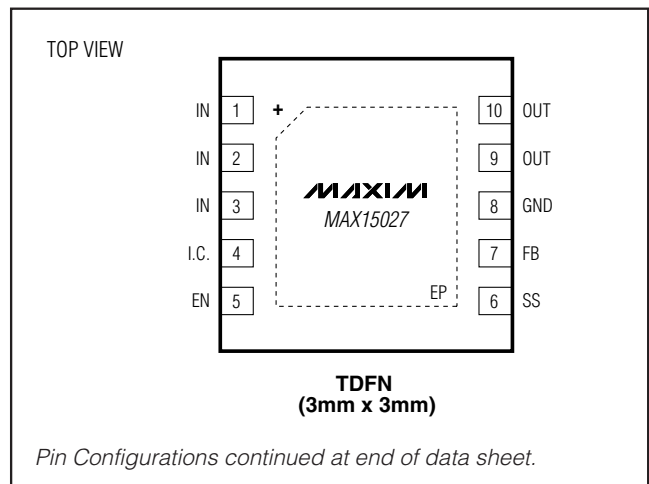

Maxim Integrated Products 1

For pricing, delivery, and ordering information, please contact Maxim Direct at 1-888-629-4642, or visit Maxim's website at www.maxim-ic.com.

1.425V to 3.6V Input, 1A Low-Dropout Regulators with BIAS Input

ABSOLUTE MAXIMUM RATINGS

IN, FB, SS, I.C. to GND.....	-0.3V to +4.0V
BIAS to GND.....	-0.3V to +6V
EN to GND.....	-0.3V to the lower of (V _{BIAS} + 0.3V) or +6V
OUT to GND.....	-0.3V to (V _{IN} + 0.3V)
Output Short-Circuit Duration.....	Continuous
Continuous Power Dissipation (T _A = +70°C)	
10-Pin TDFN, Multilayer Board	
(derate 24.4mW/°C above +70°C).....	1951mW

Junction-to-Case Thermal Resistance, θ_{JC}	9°C/W
Junction-to-Ambient Thermal Resistance, θ_{JA} (Note 1).....	41°C/W
Operating Junction Temperature Range.....	-40°C to +125°C
Maximum Junction Temperature.....	+150°C
Storage Temperature Range.....	-65°C to +150°C
Lead Temperature (soldering, 10s).....	+300°C
Soldering Temperature (reflow).....	+260°C

Note 1: Package thermal resistances were obtained using the method described in JEDEC specification JESD51-7, using a four-layer board. For detailed information on package thermal considerations, refer to www.maxim-ic.com/thermal-tutorial.

Stresses beyond those listed under "Absolute Maximum Ratings" may cause permanent damage to the device. These are stress ratings only, and functional operation of the device at these or any other conditions beyond those indicated in the operational sections of the specifications is not implied. Exposure to absolute maximum rating conditions for extended periods may affect device reliability.

ELECTRICAL CHARACTERISTICS

(Circuit of Figure 1; V_{IN} = 1.8V, V_{OUT} = 1.2V, EN = IN for MAX15027, EN = BIAS for MAX15028, I_{OUT} = 100mA, T_A = T_J = -40°C to +125°C. Typical values are at T_A = +25°C, unless otherwise noted.) (Note 2)

PARAMETER	SYMBOL	CONDITIONS	MIN	TYP	MAX	UNITS	
IN							
Input Voltage Range	V _{IN}	MAX15027	1.425		3.600	V	
		MAX15028	V _{BIAS} = 3V to 5.5V BIAS = IN	1.425 3.000			3.600 3.600
Undervoltage Lockout	V _{UVLO}	V _{IN} rising, I _{OUT} = 2mA	MAX15027	1.275	1.325	1.375	V
		MAX15028	1.04	1.106	1.14		
Undervoltage Lockout Hysteresis	V _{UVLO_HYST}			50		mV	
Quiescent GND Current	I _{GND}	V _{IN} = 1.425V to 3.6V, V _{OUT} = 1.2V, I _{OUT} = 1mA, V _{BIAS} = 3.3V		160	275	410	μA
		V _{IN} = 3.6V, V _{OUT} = 3.3V, I _{OUT} = 100mA		180	275	560	
		V _{IN} = 3.3V, V _{OUT} = 3.3V, I _{OUT} = 500mA		170	315	470	
Input Supply Current in Shutdown	I _{IN_SD}	V _{EN} = 0V, T _A = -40°C to +85°C		0.1	5.5	μA	
BIAS (MAX15028)							
Input Voltage Range	V _{BIAS}		3		5.5	V	
Undervoltage Lockout	V _{BIAS_UVLO}	V _{BIAS} rising, I _{OUT} = 2mA	2.3	2.5	2.7	V	
Undervoltage Lockout Hysteresis		I _{OUT} = 2mA		110		mV	
Quiescent Input Supply Current	I _{BIAS}	V _{EN} = V _{BIAS}	20	60	120	μA	
Input Supply Current in Shutdown	I _{BIAS_SD}	EN = GND	V _{IN} = 0V, V _{OUT} = 0V, V _{BIAS} = 3.3V		1.2	2	μA
			V _{IN} = 3.3V, V _{OUT} = 0V, V _{BIAS} = 3.3V		1.2	2	
			V _{IN} = 3.3V, V _{OUT} = 0V, V _{BIAS} = 5V		1.5	3	

1.425V to 3.6V Input, 1A Low-Dropout Regulators with BIAS Input

MAX15027/MAX15028

ELECTRICAL CHARACTERISTICS (continued)

(Circuit of Figure 1; $V_{IN} = 1.8V$, $V_{OUT} = 1.2V$, EN = IN for MAX15027, EN = BIAS for MAX15028, $I_{OUT} = 100mA$, $T_A = T_J = -40^{\circ}C$ to $+125^{\circ}C$. Typical values are at $T_A = +25^{\circ}C$, unless otherwise noted.) (Note 2)

PARAMETER	SYMBOL	CONDITIONS	MIN	TYP	MAX	UNITS
OUT						
Output Voltage Range	V_{OUT}		0.5		3.3	V
Load Regulation		$I_{OUT} = 1mA$ to 1A		0.01		mV/mA
Line Regulation		$V_{IN} = 1.425V$ to 3.6V, $I_{OUT} = 1mA$		4		mV
Dropout Voltage ($V_{IN} - V_{OUT}$)	V_{DO}	$I_{OUT} = 1A$, $V_{IN} = 1.5V$		75	225	mV
Output Current Limit	I_{LIM}	$V_{FB} = 300mV$	1.4	1.7	2.0	A
FB						
Threshold Accuracy	V_{FB}	$V_{OUT} = 0.5V$ to 3.3V, $V_{IN} = (V_{OUT} + 0.3V)$ to 3.6V, $I_{OUT} = 1mA$ to 1A	0.489	0.499	0.509	mV
Input Current	I_{FB}	$V_{FB} = 0.688V$		0.1	0.2	μA
EN/SOFT-START						
Enable Input Threshold (MAX15028)	V_{IH}	$V_{BIAS} = 5V$	1.05		0.4	V
	V_{IL}					
Enable Input Threshold (MAX15027)	V_{IH}	$V_{IN} = 1.8V$	1.05		0.4	V
	V_{IL}					
Soft-Start Charging Current	I_{SS}		5			μA
Soft-Start Reference Voltage	V_{SS}		0.499			V
THERMAL SHUTDOWN						
Thermal-Shutdown Threshold		T_J rising	165			$^{\circ}C$
Thermal-Shutdown Hysteresis			15			$^{\circ}C$

Note 2: All devices are 100% production tested at $T_A = +25^{\circ}C$. Limits over the operating temperature range are guaranteed by design and characterization.

1.425V to 3.6V Input, 1A Low-Dropout Regulators with BIAS Input

Typical Operating Characteristics

(Circuit of Figure 1, $V_{IN} = 1.8V$, $V_{OUT} = 1.5V$, $I_{OUT} = 1A$, $T_A = +25^\circ C$, unless otherwise noted.)

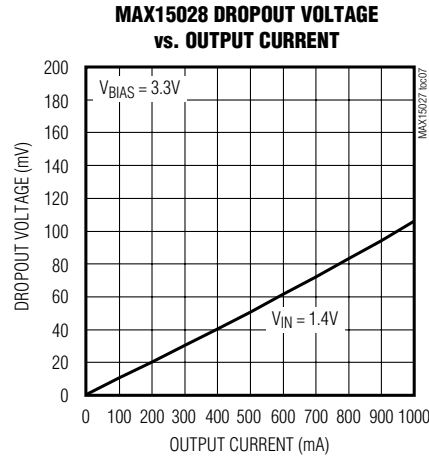
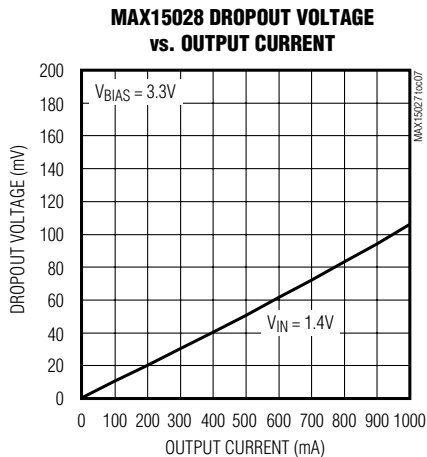
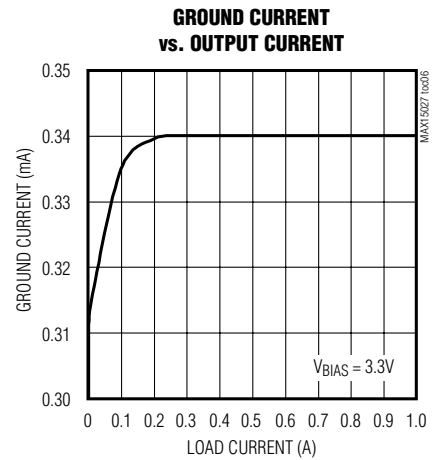
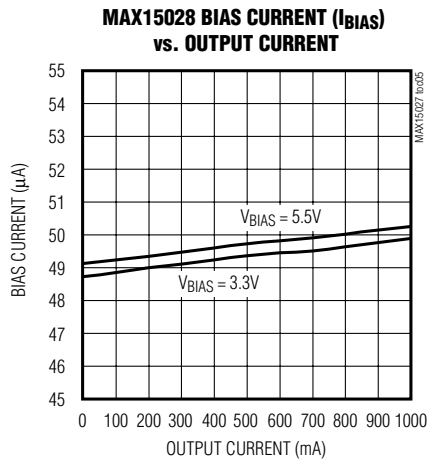
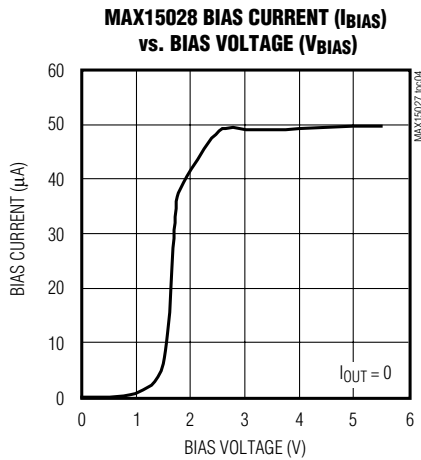
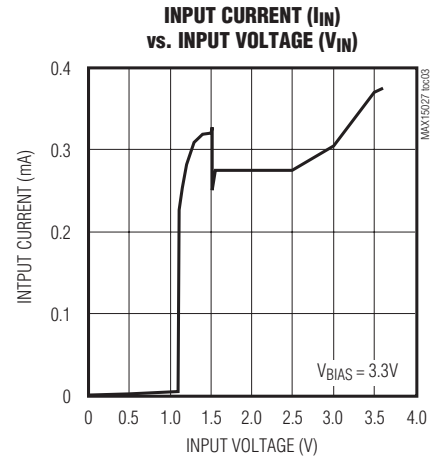
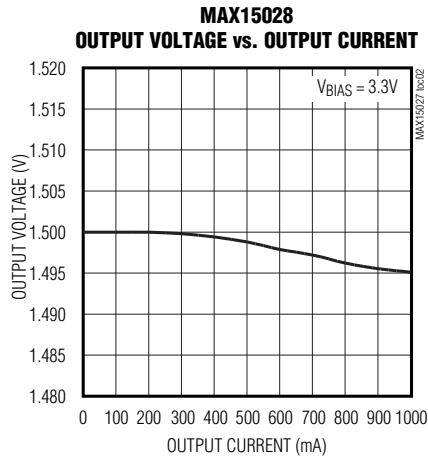
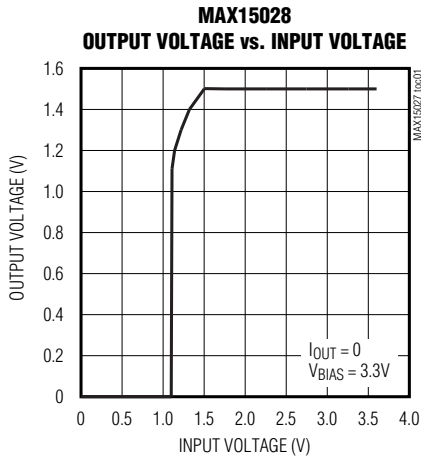

1.425V to 3.6V Input, 1A Low-Dropout Regulators with BIAS Input

Typical Operating Characteristics (continued)

(Circuit of Figure 1, $V_{IN} = 1.8V$, $V_{OUT} = 1.5V$, $I_{OUT} = 1A$, $T_A = +25^\circ C$, unless otherwise noted.)

MAX15027/MAX15028

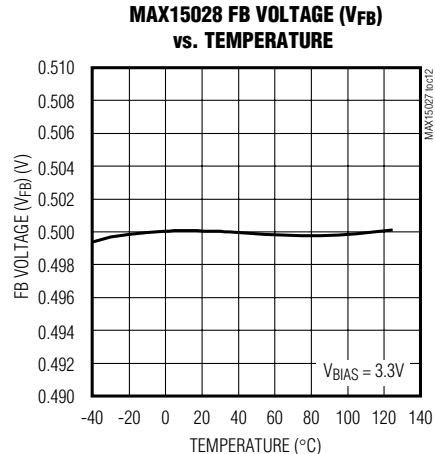
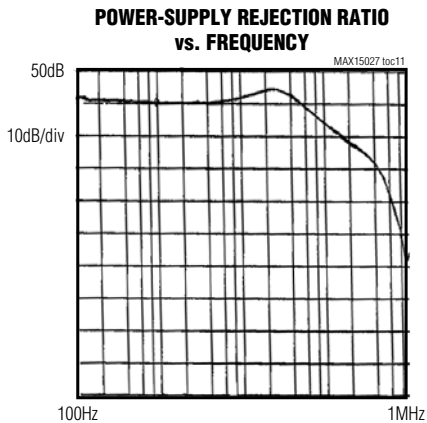
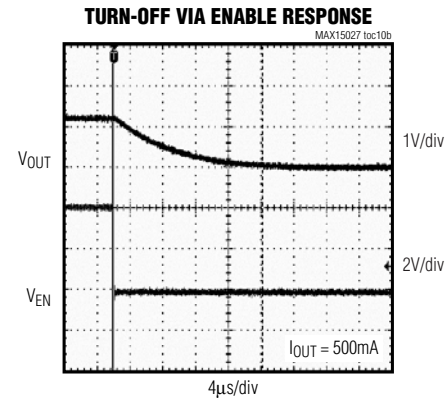
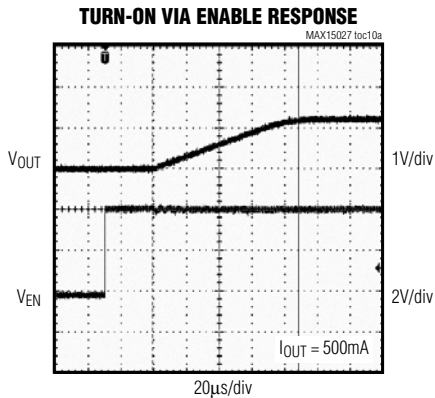
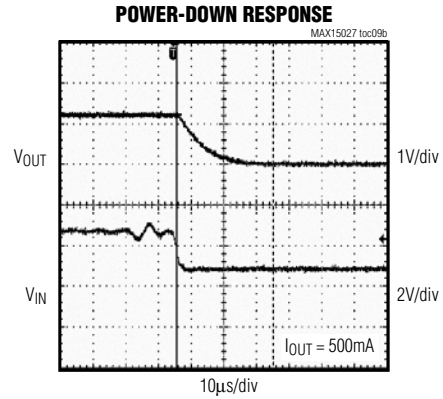
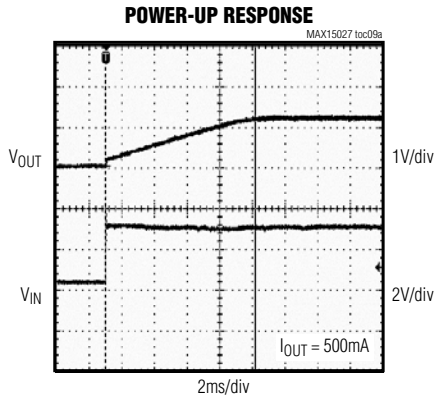

1.425V to 3.6V Input, 1A Low-Dropout Regulators with BIAS Input

Typical Operating Characteristics (continued)

(Circuit of Figure 1, $V_{IN} = 1.8V$, $V_{OUT} = 1.5V$, $I_{OUT} = 1A$, $T_A = +25^\circ C$, unless otherwise noted.)

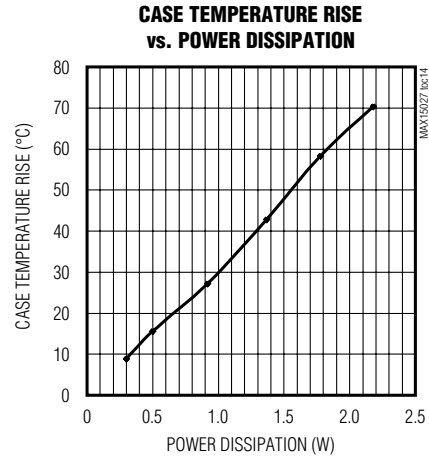
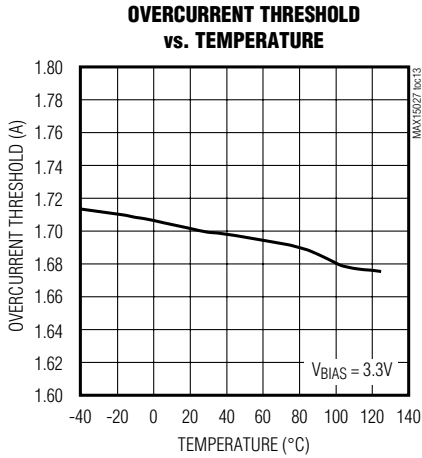

Pin Description

PIN		NAME	FUNCTION
MAX15027	MAX15028		
1, 2, 3	1, 2	IN	Regulator Input. 1.425V to 3.6V voltage range. Bypass to GND with at least 1 μ F of ceramic capacitance. IN is high impedance when the LDO is shut down.
—	3	BIAS	Internal Circuitry Supply Input. BIAS supplies the power for the internal circuitry. 3V to 5.5V voltage range.
4	4	I.C.	Internally Connected. Connect I.C. directly to GND.
5	5	EN	LDO Enable. Drive EN high to enable the LDO or connect to IN (BIAS for MAX15028) for always-on operation. Drive EN low to disable the LDO and place the IC in low-power shutdown mode.
6	6	SS	Soft-Start Input. For typical operation, connect a 0.1 μ F capacitor from SS to GND. The soft-start timing is dependent on the value of this capacitor. See the <i>Soft-Start</i> section.
7	7	FB	Feedback Input. Connect FB to the center of a resistor-divider connected between OUT and GND to set the output voltage. See the <i>Programming the Output Voltage</i> section.
8	8	GND	Ground
9, 10	9, 10	OUT	Regulator Output. Bypass OUT to GND with at least 4.7 μ F of ceramic capacitance for 1A load operation.
—	—	EP	Exposed Pad. Connect EP to GND and a large copper ground plane to facilitate package power dissipation.

1.425V to 3.6V Input, 1A Low-Dropout Regulators with BIAS Input

Functional Diagram

MAX15027/MAX15028

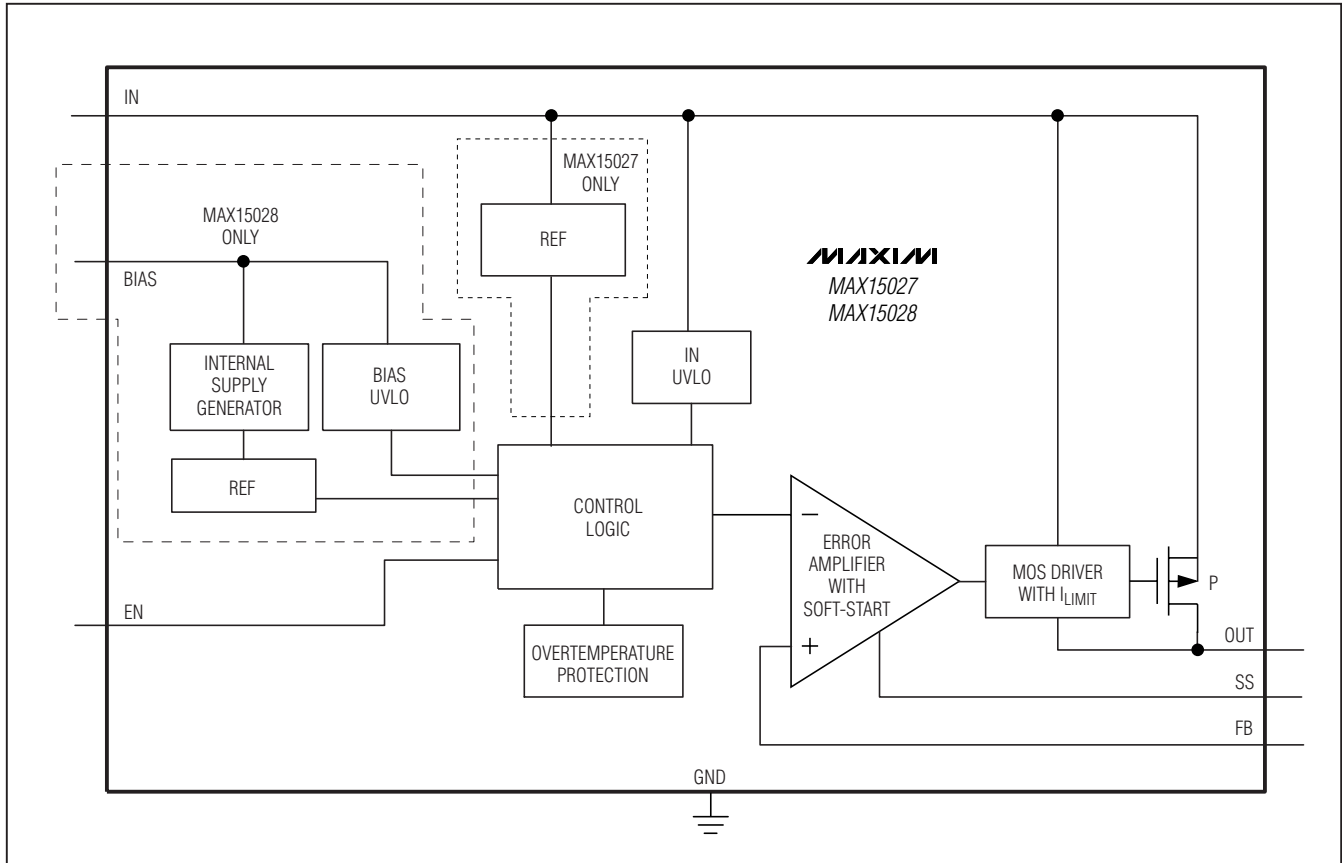

Detailed Description

The MAX15027/MAX15028 low-dropout linear regulators operate from input voltages as low as 1.425V and deliver up to 1A of continuous output current with a maximum dropout voltage of only 225mV.

The MAX15028 operates with an input voltage as low as 1.425V if the bias voltage (V_{BIAS}) of 3V to 5.5V is available. The power is applied at IN while the control is provided through BIAS input. The current drawn by BIAS is negligible when the LDO goes into shutdown. This feature is especially useful in automotive applica-

tions where the BIAS input is derived from an always-on LDO that expects to provide minimal power during the key-off condition.

The pMOS output stage can be driven from input voltages down to +1.425V without sacrificing stability or transient performance. The output voltage of all the regulators is adjustable from 0.5V to V_{IN} and is $\pm 2\%$ accurate over load and line variations, from -40°C to $+125^{\circ}\text{C}$. Since these regulators have a pMOS output device, supply current is not a significant function of load or input headroom.

1.425V to 3.6V Input, 1A Low-Dropout Regulators with BIAS Input

Internal p-Channel Pass Transistor

The MAX15027/MAX15028 feature a 75mΩ (typ) p-channel MOSFET pass transistor. Unlike similar designs using pnp pass transistors, p-channel MOSFETs require no base drive, reducing quiescent current.

pnp-based regulators also waste considerable current in dropout when the pass transistor saturates and use high base-drive currents under large loads. The MAX15027/MAX15028 do not suffer from these problems and consume only 275μA (typ) of quiescent current under heavy loads, as well as in dropout.

Short-Circuit/ Thermal Fault Protection

The MAX15027/MAX15028 are fully protected from a short circuit at the output through current limiting and thermal-overload circuitry. In the fault condition when the output is shorted to ground, the output current is limited to a maximum of 2A. Under these conditions, the device quickly heats up. When the junction temperature reaches +165°C (typ), the thermal-overload circuitry turns off the output, allowing the part to cool down. When the junction temperature cools to +150°C (typ), the output turns back on and reestablishes regulation. Current limiting and thermal protection continue until the fault is removed. For continuous operation, do not exceed the absolute maximum junction-temperature rating of $T_J = +150^\circ\text{C}$.

Soft-Start

The MAX15027/MAX15028 feature a soft-start function that slowly ramps up the output voltage of the regulator based on the value of the capacitor (C_{SS}) connected from SS to GND. Upon power-up, C_{SS} is charged with a 5μA (typ) current source through SS. The voltage at SS is compared to the internal 0.5V reference (V_{REF}). The feedback voltage for regulation (V_{REG}) is the lower of V_{SS} or V_{REF} . As V_{SS} rises, the regulation voltage (V_{REG}) rises at the same rate. Once V_{SS} reaches and rises above V_{REF} , the regulation voltage then tracks the reference voltage since it is the lower of V_{SS} and V_{REF} . The value of C_{SS} determines the length of the soft-start time, t_{SS} . Use the following formula to determine C_{SS} .

$$C_{SS} = 10^{-5} \times t_{SS}$$

where C_{SS} is in farads and t_{SS} is in seconds.

Shutdown Mode

The MAX15027/MAX15028 include an enable input. To shut down the IC, drive EN low. In shutdown mode, the current drawn by BIAS is less than 2μA. This feature is extremely useful in an automotive application where the BIAS input is derived from an always-on LDO expecting to provide minimal dark current. For normal operation, drive EN high or connect EN to IN (BIAS for MAX15028) for continuous on operation. During shutdown, an internal 10kΩ resistor is connected between OUT and GND.

Applications Information

Programming the Output Voltage

The MAX15027/MAX15028 feature an adjustable output voltage from 0.5V to V_{IN} using two external resistors connected as a voltage-divider to FB as shown in Figure 1. The output voltage is set by the following equation:

$$V_{OUT} = V_{FB} \left(1 + \frac{R1}{R2} \right)$$

where typically $V_{FB} = 0.5\text{V}$. Choose $R2$ to be 10kΩ. Or, to optimize load-transient response for no load to full load transients, use the resistor-divider as a minimum load and choose $R2$ to be 500Ω. To simplify resistor selection:

$$R1 = R2 \left(\frac{V_{OUT}}{V_{FB}} - 1 \right)$$

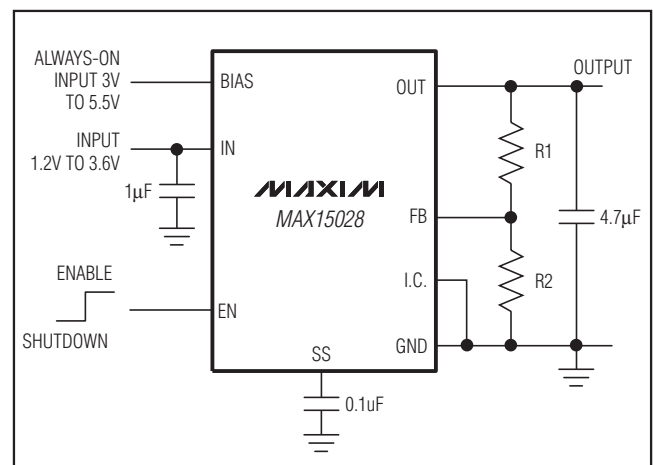

Figure 1. MAX15028 Typical Application Circuit

1.425V to 3.6V Input, 1A Low-Dropout Regulators with BIAS Input

Capacitor Selection and Regulator Stability

Capacitors are required at the MAX15027/MAX15028's inputs and outputs for stable operation over the full temperature range and with load currents up to 1A. Connect a 1 μ F capacitor between IN and ground and a 4.7 μ F capacitor with low equivalent series resistance (ESR) between OUT and ground for 1A output current.

The input capacitor (C_{IN}) lowers the source impedance of the input supply. If input supply source impedance is high, place a larger input capacitor close to IN to prevent V_{IN} sagging due to load transients. Smaller output capacitors can be used for output currents less than 1A. Calculate the minimum C_{OUT} as follows:

$$C_{OUT} = I_{OUT(MAX)} \times \left(\frac{1\mu F}{0.25A} \right)$$

Operating Region and Power Dissipation

The maximum power dissipation depends on the thermal resistance of the IC package and circuit board, the temperature difference between the die junction and ambient air, and the rate of airflow. The power dissipated in the device is $P_{DISS} = I_{OUT} (V_{IN} - V_{OUT})$. The package features an exposed thermal pad on its underside. This pad lowers the thermal resistance of the package by providing a direct heat conduction path from the die to the PCB. Connect the exposed backside pad and GND to the system ground using a large pad or ground plane and multiple vias to the ground plane layer.

Noise, PSRR, and Transient Response

The MAX15027/MAX15028 are designed to operate with low-dropout voltages and low quiescent currents while still maintaining good noise performance, transient response, and AC rejection (see the *Typical Operating Characteristics* for a plot of Power-Supply Rejection Ratio (PSRR) vs. Frequency). When operating from noisy sources, improved supply-noise rejection and transient response can be achieved by increasing the values of the input and output bypass capacitors and through passive filtering techniques. The MAX15027/MAX15028 load-transient response graphs (see the *Typical Operating Characteristics*) show two components of the output response: a DC shift from the output impedance due to the load current change, and the transient response. A typical transient overshoot for a step change in the load current from 300mA to 800mA is 15mV. Use ceramic output capacitors greater than 4.7 μ F (up to 100 μ F) to attenuate the overshoot.

Layout Guidelines

The TDFN package has an exposed thermal pad on its underside. This pad provides a low thermal resistance path for heat transfer into the PCB. This low thermally resistive path carries a majority of the heat away from the IC. The PCB is effectively a heatsink for the IC. The exposed pad should be connected to a large ground plane for proper thermal and electrical performance. The minimum size of the ground plane is dependent upon many system variables. To create an efficient path, the exposed pad should be soldered to a thermal landing, which is connected to the ground plane by thermal vias. The thermal landing should be at least as large as the exposed pad.

1.425V to 3.6V Input, 1A Low-Dropout Regulators with BIAS Input

Typical Operating Circuits

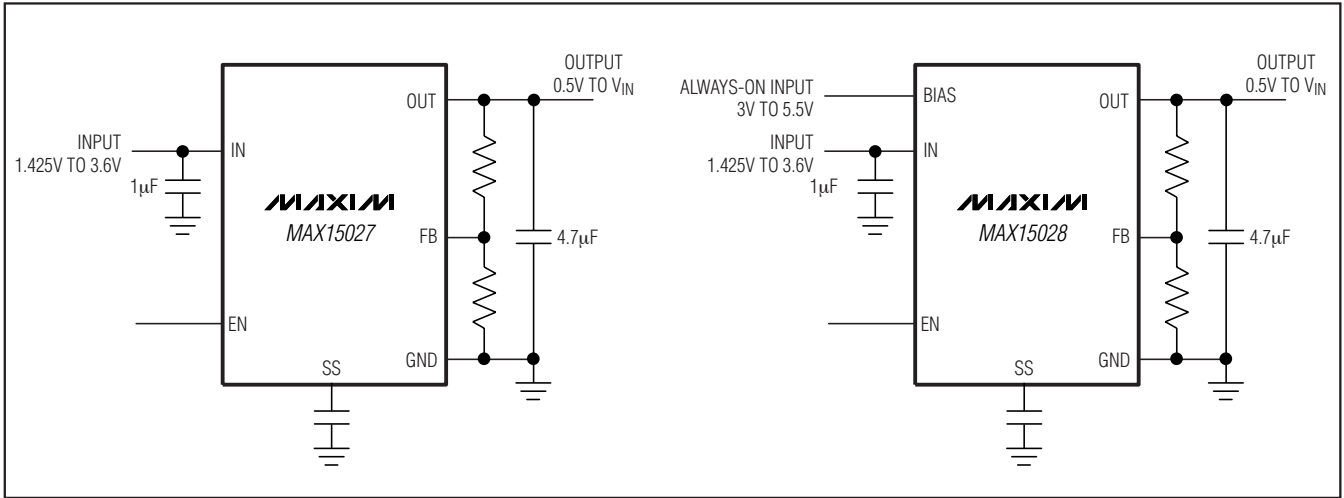

Pin Configurations (continued)

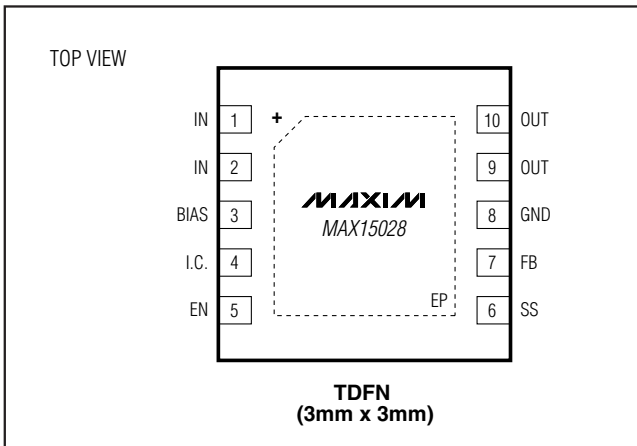

Chip Information

PROCESS: BiCMOS

Package Information

For the latest package outline information and land patterns, go to www.maxim-ic.com/packages. Note that a "+", "#", or "-" in the package code indicates RoHS status only. Package drawings may show a different suffix character, but the drawing pertains to the package regardless of RoHS status.

PACKAGE TYPE	PACKAGE CODE	OUTLINE NO.	LAND PATTERN NO.
10 TDFN-EP	T1033-1	21-0137	90-0003

1.425V to 3.6V Input, 1A Low-Dropout Regulators with BIAS Input

Revision History

REVISION NUMBER	REVISION DATE	DESCRIPTION	PAGES CHANGED
0	3/09	Initial release	—
1	5/10	Revised the <i>Features, Ordering Information, and the Absolute Maximum Ratings</i> .	1, 2

MAX15027/MAX15028

Maxim cannot assume responsibility for use of any circuitry other than circuitry entirely embodied in a Maxim product. No circuit patent licenses are implied. Maxim reserves the right to change the circuitry and specifications without notice at any time.

Maxim Integrated Products, 120 San Gabriel Drive, Sunnyvale, CA 94086 408-737-7600 _____ 11

© 2010 Maxim Integrated Products

Maxim is a registered trademark of Maxim Integrated Products, Inc.