

General Description

The MIC5311 is a high performance, dual μ Cap low dropout regulator offering ultra-low operating current and a second, even lower operating current mode, LowQ™ mode, reducing operating current by 75%. Each regulator can source up to 300mA of output current maximum.

Ideal for battery operated applications, the MIC5311 offers 1% accuracy, extremely low dropout voltage (60mV @ 150mA), and low ground current (typically 28 μ A total). When put into LowQ™ mode, the internal current draw drops down to 7 μ A total. The MIC5311 also comes equipped with a TTL logic compatible enable pin that allows the part to be put into a zero-off-mode current state, drawing no current when disabled.

The MIC5311 is a μ Cap design, operating with very small ceramic output capacitors for stability, reducing required board space and component cost.

The MIC5311 is available in fixed output voltages in the 3mm x 3mm MLF-10 leadless package. Data sheets and support documentation can be found on Micrel's web site at www.micrel.com.

Features

- Input voltage range: 2.5V to 5.5V
- LowQ™ Mode
 - 7 μ A total quiescent current
 - 10mA output current capable LowQ™ mode
 - Logic level control with external pin
- Stable with ceramic output capacitor
- 2 LDO Outputs – 300mA each
- Tiny 3mm x 3mm MLF™-10 package
- Low dropout voltage of 60mV @ 150mA
- Ultra-low quiescent current of 28 μ A total in Full Current Mode
- High output accuracy
 - $\pm 1.0\%$ initial accuracy
 - $\pm 2.0\%$ over temperature
- Thermal Shutdown Protection
- Current Limit Protection

Applications

- Cellular/PCS phones
- Wireless modems
- PDAs
- MP3 Players

Typical Application

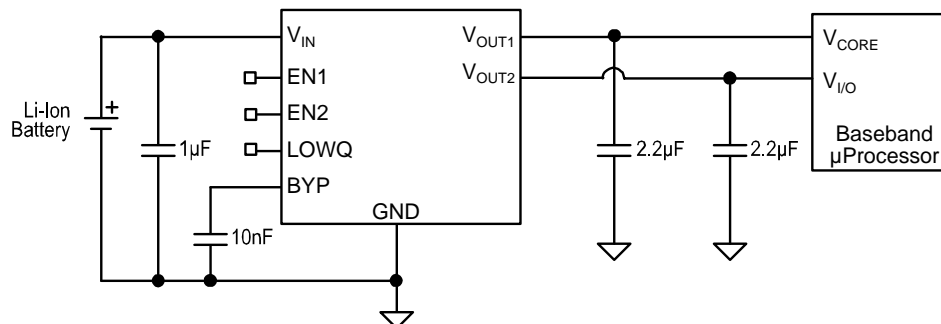

MIC5311-xxBML

MLF and MicroLeadFrame are trademarks of Amkor Technology, Inc.

Micrel Inc. • 2180 Fortune Drive • San Jose, CA 95131 • USA • tel +1 (408) 944-0800 • fax +1 (408) 474-1000 • <http://www.micrel.com>

Ordering Information

Part Number		Output Voltage*	Junction Temp. Range	Package
Standard	Pb-Free			
MIC5311-GMBML	MIC5311-GMYML	1.8V/2.8V	-40°C to +125°C	10-Pin 3x3 MLF™
MIC5311-DKBML	MIC5311-DKYML	1.85V/2.6V	-40°C to +125°C	10-Pin 3x3 MLF™
	MIC5311-NLYML	2.85V/2.7V	-40°C to +125°C	10-Pin 3x3 MLF™

Note: *Other Voltage options available between 1.25V and 5V. Contact Micrel for details.

Pin Configuration

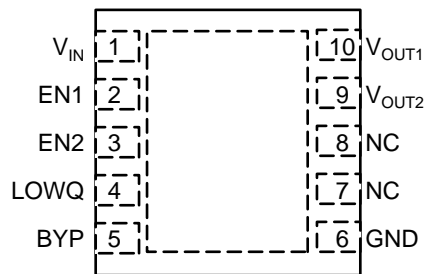

MIC5311-xxBML (3x3)

Pin Description

Fixed	Pin Name	Pin Function
1	V_{IN}	Supply Input. (V_{IN1} and V_{IN2} are internally tied together)
2	EN1	Enable Input (regulator 1). Active High Input. Logic High = On; Logic Low = Off; Do not leave floating
3	EN2	Enable Input (regulator 2). Active High Input. Logic High = On; Logic Low = Off; Do not leave floating
4	LowQ™	LowQ™ Mode. Active Low Input. Logic High = Full Power Mode; Logic Low = Light Load Mode; Do not leave floating.
5	BYP	Reference Bypass: Connect external 0.01 μ F to GND to reduce output noise. May be left open.
6	GND	Ground.
7	NC	
8	NC	
9	V_{OUT2}	Output of regulator 2
10	V_{OUT1}	Output of regulator 1
EP	GND	Ground. Internally connected to the Exposed Pad.

Absolute Maximum Ratings⁽¹⁾

Supply Input Voltage (V_{IN})	0V to 6V
Enable Input Voltage (V_{EN})	0V to 6V
LowQ™ Input Voltage ($V_{LOWQ™}$)	0V to 6V
Power Dissipation (P_D)	Internally Limited ⁽³⁾
Junction Temperature	-40°C to +125°C
Lead Temperature (soldering, 5sec.)	260°C
Storage Temperature (T_s)	-65°C to +150°C

Operating Ratings⁽²⁾

Supply Input Voltage (V_{IN})	2.5V to 5.5V
Enable Input Voltage (EN1/EN2/LowQ™)	0V to V_{IN}
Junction Temperature (T_J)	-40°C to +125°C
Package Thermal Resistance	
MLF-10 (θ_{JA})	63°C/W

Electrical Characteristics (Full Power Mode)

$V_{IN} = V_{OUT} + 1.0V$ for higher output of the regulator pair; LowQ™ = V_{IN} ; $C_{OUT} = 2.2\mu F$, $I_{OUT} = 100\mu A$; $T_J = 25^\circ C$, **bold** values indicate -40°C to +125, unless noted.

Parameter	Conditions	Min	Typ	Max	Units
Output Voltage Accuracy	Variation from nominal V_{OUT}	-1.0		+1.0	%
	Variation from nominal V_{OUT} ; -40°C to +125°C	-2.0		+2.0	%
Line Regulation	$V_{IN} = V_{OUT} + 1V$ to 5.5V		0.02	0.3 0.6	%/V
Load Regulation	$I_{OUT} = 100\mu A$ to 150mA		0.35	1.0	%
	$I_{OUT} = 100\mu A$ to 300mA		0.7	1.5	%
Dropout Voltage	$I_{OUT} = 150mA$		60		mV
	$I_{OUT} = 300mA$		120	240	mV
Ground Pin Current	$I_{OUT1} = I_{OUT2} = 100\mu A$ to 300mA		28	45	μA
				50	μA
Ground Pin Current in Shutdown	$V_{EN} \leq 0.2V$		0.1		μA
Ripple Rejection	$f = \text{up to } 1kHz$; $C_{OUT} = 2.2\mu F$ ceramic; $C_{BYP} = 10nF$		65		dB
	$f = 1kHz - 20kHz$; $C_{OUT} = 2.2\mu F$ ceramic; $C_{BYP} = 10nF$		35		dB
Current Limit	$V_{OUT} = 0V$ (Both Regulators)	350	450	700	mA
Output Voltage Noise	$C_{OUT} = 2.2\mu F$, $C_{BYP} = 0.01\mu F$, 10Hz to 100kHz		45		μV_{rms}
Enable and LowQ™ Input (EN1/EN2/LowQ™)					
Enable Input Voltage	Logic Low			0.2	V
	Logic High	1.0			V
Enable Input Current	$V_{IL} \leq 0.2V$		0.1	1	μA
	$V_{IH} \geq 1.0V$		0.1	1	μA
Turn-on Time	$C_{OUT} = 2.2\mu F$; $C_{BYP} = 0.01\mu F$		300	500	μs
Light Load Response					
Response Time ⁽⁴⁾	Into Light Load		50		μs
	Out of Light Load		50		μs

Electrical Characteristics (LowQ™ Mode)

$V_{IN} = V_{OUT} + 1.0V$ for higher output of the regulator pair; LowQ™ = 0V; $C_{OUT} = 2.2\mu F$, $I_{OUT} = 100\mu A$; $T_J = 25^\circ C$, **bold** values indicate $-40^\circ C$ to $+125^\circ C$, unless noted.

Parameter	Conditions	Min	Typ	Max	Units
Output Voltage Accuracy	Variation from nominal V_{OUT}	-2.0 -3.0		+2.0 +3.0	% %
Line Regulation	$V_{IN} = V_{OUT} + 1V$ to 5.5V		0.02	0.3 0.6	%/V
Load Regulation	$I_{OUT} = 100\mu A$ to 10mA		0.1	0.5	%
Dropout Voltage	$I_{OUT} = 10mA$		100	200	mV
Ground Pin Current	Both outputs enabled		7	10 12	μA μA
Ground Pin Current in Shutdown	$V_{EN} \leq 0.2V$		0.01	1.0	μA
Ripple Rejection	$f =$ up to 1kHz; $C_{OUT} = 2.2\mu F$ ceramic; $C_{BYP} = 10nF$ $f = 1kHz - 20kHz$; $C_{OUT} = 2.2\mu F$ ceramic; $C_{BYP} = 10nF$		45 30		dB dB
Current Limit	$V_{OUT} = 0V$ (Both regulators)	40	75	150	mA

Notes:

1. Exceeding the absolute maximum rating may damage the device.
2. The device is not guaranteed to function outside its operating rating.
3. The maximum allowable power dissipation of any T_A (ambient temperature) is $P_{D(max)} = T_{J(max)} - T_A / \theta_{JA}$. Exceeding the maximum allowable power dissipation will result in excessive die temperature, and the regulator will go into thermal shutdown.
4. Response time defined as the minimum hold-off time after the LowQ™ command before applying load transients.

Typical Characteristics

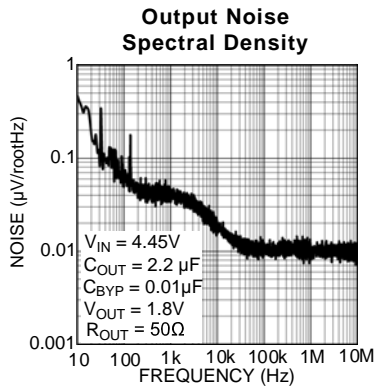
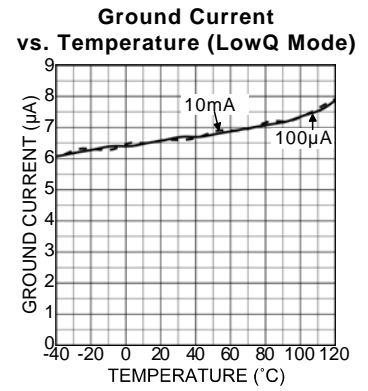
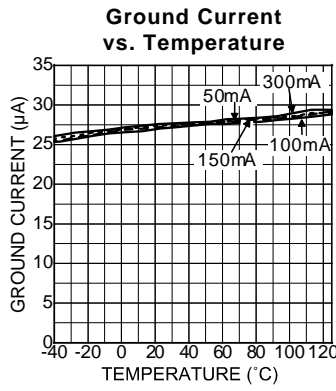
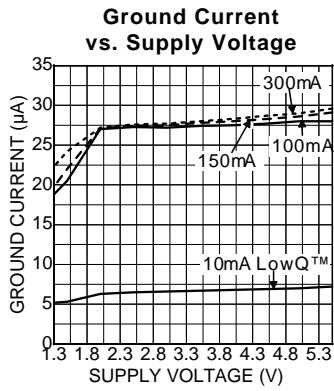
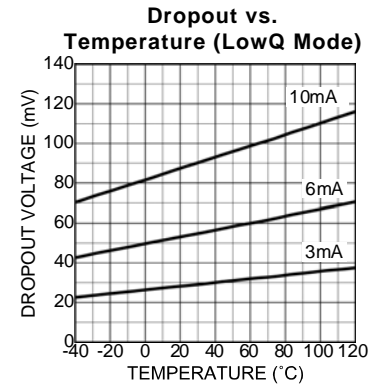
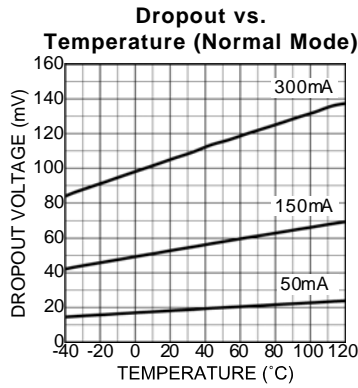
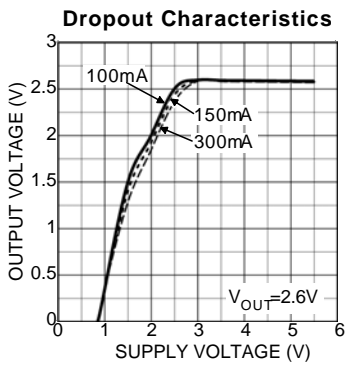
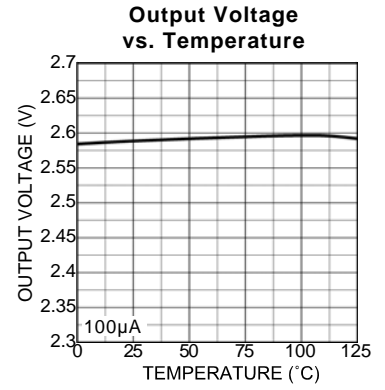
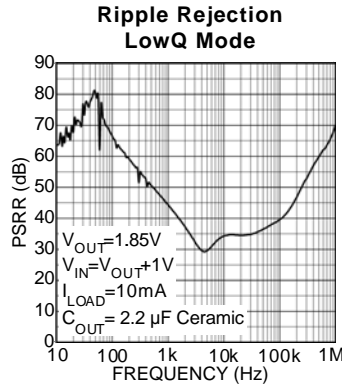
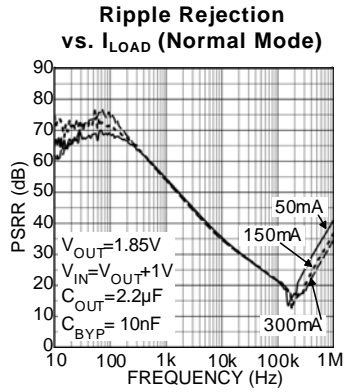

Functional Characteristics

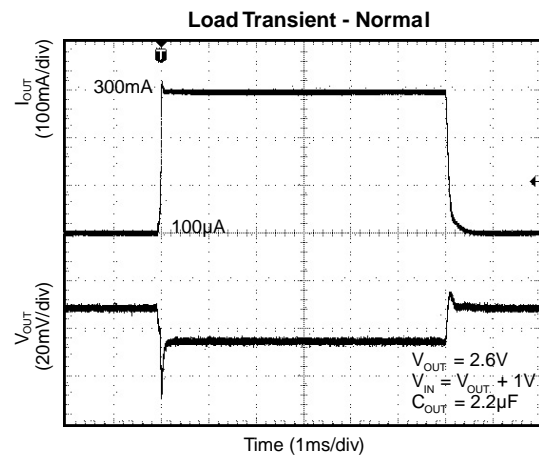
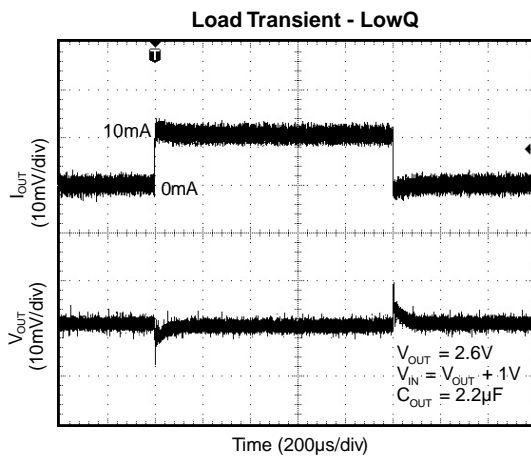
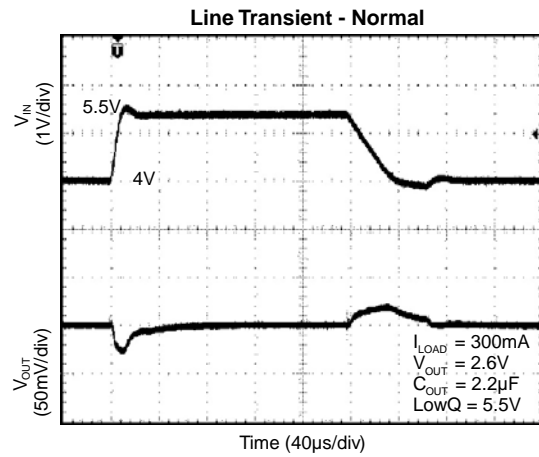
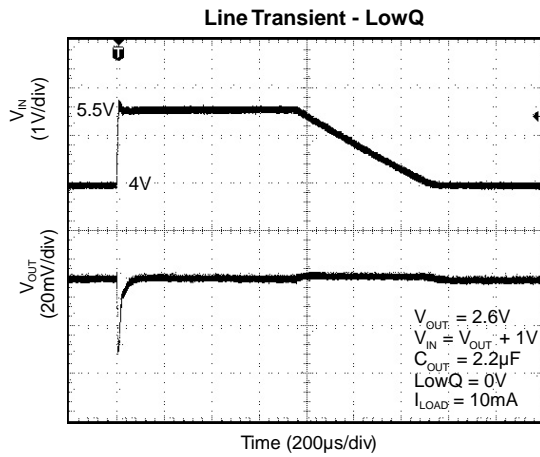
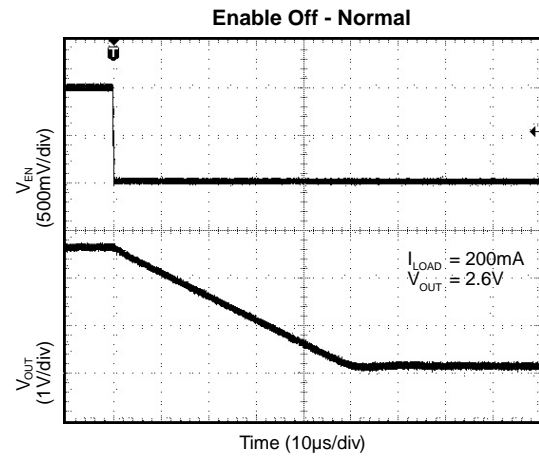
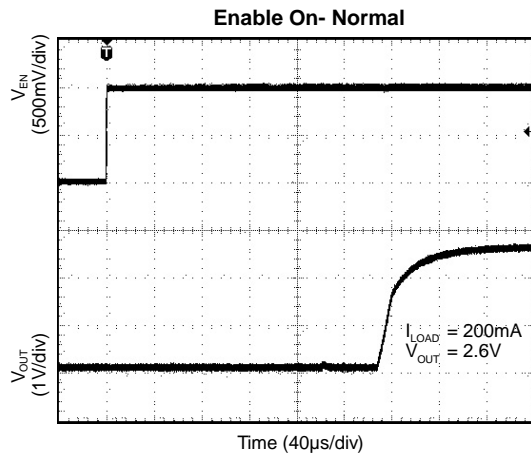

Functional Characteristics (cont.)

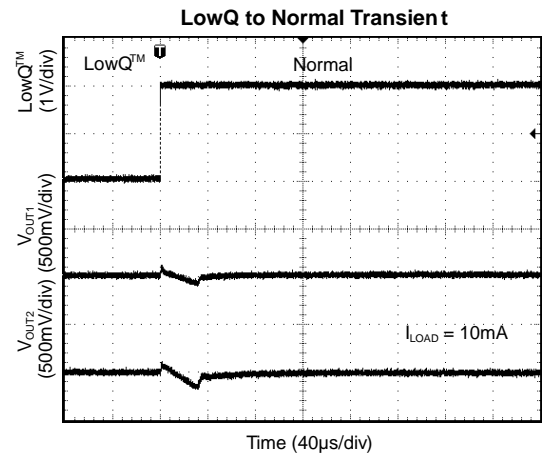
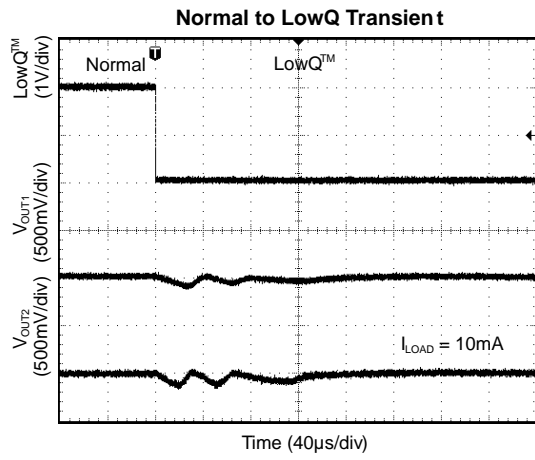

Functional Diagram

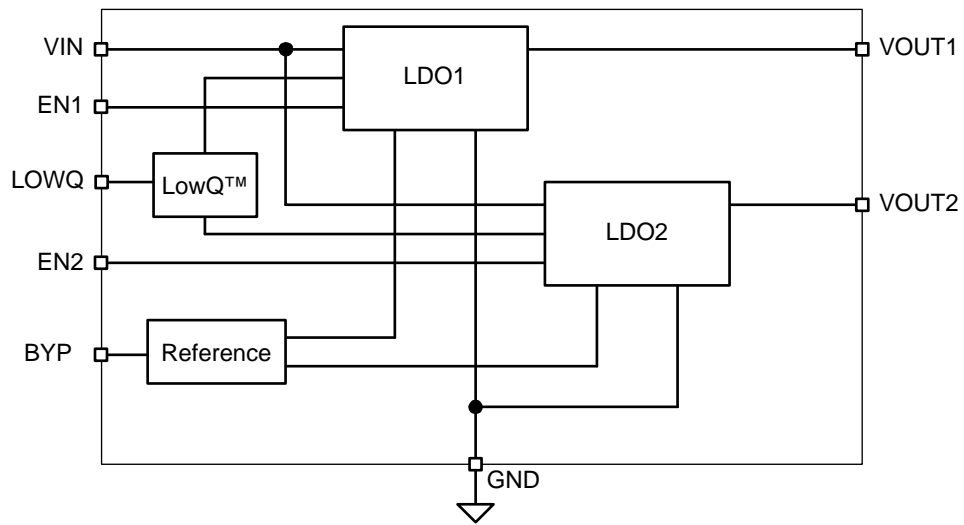

MIC5311 Block Diagram

Functional Description

The MIC5311 is a high performance, low quiescent current power management IC consisting of two μ Cap low dropout regulators with a LowQ™ mode featuring lower operating current. Both regulators are capable of sourcing 300mA.

Enable 1 and 2

The enable inputs allow for logic control of both output voltages with individual enable inputs. The enable input is active high, requiring 1.0V for guaranteed operation. The enable input is CMOS logic and cannot be left floating.

LowQ™ Mode

The LowQ™ pin is logic level low, requiring <0.2V to enter the LowQ™ mode. The LowQ™ pin cannot be left floating. Features of the LowQ™ mode include lower total quiescent current of typically 7 μ A.

Input Capacitor

Good bypassing is recommended from input to ground to help improve AC performance. A 1 μ F capacitor or greater located close to the IC is recommended. Larger load currents may require larger capacitor values.

Bypass Capacitor

The internal reference voltage of the MIC5311 can be bypassed with a capacitor to ground to reduce output noise and increase input ripple rejection (PSRR). A quick-start feature allows for quick turn-on of the output voltage. The recommended nominal bypass capacitor is 0.01 μ F, but an increase will result in longer turn on times t_{on} .

Output Capacitor

Each regulator output requires a 2.2 μ F ceramic output capacitor for stability. The output capacitor value can be increased to improve transient response, but performance has been optimized for a 2.2 μ F ceramic type output capacitor. X7R/X5R dielectric-type ceramic capacitors are recommended because of their temperature performance. X7R-type capacitors change capacitance by 15% over their operating temperature range and are the most stable type of ceramic capacitors. Z5U and Y5V dielectric capacitors change value by as much as 50% to 60% respectively over their operating temperature ranges. To use a ceramic chip capacitor with Y5V dielectric, the value must be much higher than a X7R ceramic capacitor to ensure the same minimum capacitance over the equivalent operating temperature range.

Thermal Considerations

The MIC5311 is designed to provide 300mA of continuous current per channel in a very small MLF package. Maximum power dissipation can be calculated based on the output current and the voltage drop across the part. To determine the maximum power dissipation of the package, use the junction-to-ambient thermal resistance of the device and the following basic equation:

$$P_D (\text{max}) = (T_J (\text{max}) - T_A) / \theta_{JA}$$

$T_J (\text{max})$ is the maximum junction temperature of the die, 125°C, and T_A is the ambient operating temperature. θ_{JA} is layout dependent; Table 1 shows examples of the junction-to-ambient thermal resistance for the MIC5311.

Package	θ_{JA} Recommended Minimum Footprint	θ_{JC}
3x3 MLF™-10	63°C/W	2°C/W

Table 1. MLF™ Thermal Resistance

The actual power dissipation of the regulator circuit can be determined using the equation:

$$P_{DTOTAL} = P_{D LDO1} + P_{D LDO2}$$

$$P_{D LDO1} = (V_{IN} - V_{OUT1}) \times I_{OUT1}$$

$$P_{D LDO2} = (V_{IN} - V_{OUT2}) \times I_{OUT2}$$

Substituting $P_{D(\text{max})}$ for P_D and solving for the operating conditions that are critical to the application will give the maximum operating conditions for the regulator circuit. For example, when operating the MIC5311 at 60°C with a minimum footprint layout, the maximum load currents can be calculated as follows:

$$P_D (\text{max}) = (T_J (\text{max}) - T_A) / \theta_{JA}$$

$$P_D (\text{max}) = (125^\circ\text{C} - 60^\circ\text{C}) / 63^\circ\text{C/W}$$

$$P_D (\text{max}) = 1.03\text{W}$$

The junction-to-ambient thermal resistance for the minimum footprint is **63°C/W**, from Table 1. The maximum power dissipation must not be exceeded for proper operation. Using a lithium-ion battery as the supply voltage of 4.2V, 1.8V_{OUT}/150mA for channel 1 and 2.8V_{OUT}/100mA for channel 2, power dissipation can be calculated as follows:

$$P_{D LDO1} = (V_{IN} - V_{OUT1}) \times I_{OUT1}$$

$$P_{D LDO1} = (4.2\text{V} - 1.8\text{V}) \times 150\text{mA}$$

$$P_{D LDO1} = 360\text{mW}$$

$$P_{D LDO2} = (V_{IN} - V_{OUT2}) \times I_{OUT2}$$

$$P_{D LDO1} = (4.2\text{V} - 2.8\text{V}) \times 100\text{mA}$$

$$P_{D LDO1} = 140\text{mW}$$

$$P_{DTOTAL} = P_{DLDO1} + P_{DLDO2}$$

$$P_{DTOTAL} = 360\text{mW} + 140\text{mW}$$

$$P_{DTOTAL} = 500\text{mW}$$

$$T_{A(max)} = T_{J(max)} - (P_D \times \theta_{JA})$$

$$T_{A(max)} = 125^\circ\text{C} - (500\text{mW} \times 63^\circ\text{C/W})$$

$$T_{A(max)} = 93.5^\circ\text{C}$$

The calculation shows that we are well below the maximum allowable power dissipation of **1.03W** for a 60° ambient temperature.

After the maximum power dissipation has been calculated, it is always a good idea to calculate the maximum ambient temperature for a 125° junction temperature. Calculating maximum ambient temperature as follows:

For a full discussion of heat sinking and thermal effects on voltage regulators, refer to the "Regulator Thermals" section of *Micrel's Designing with Low-Dropout Voltage Regulators* handbook.

This information can be found on Micrel's website at: http://www.micrel.com/_PDF/other/LDOBk_ds.pdf

Package Information

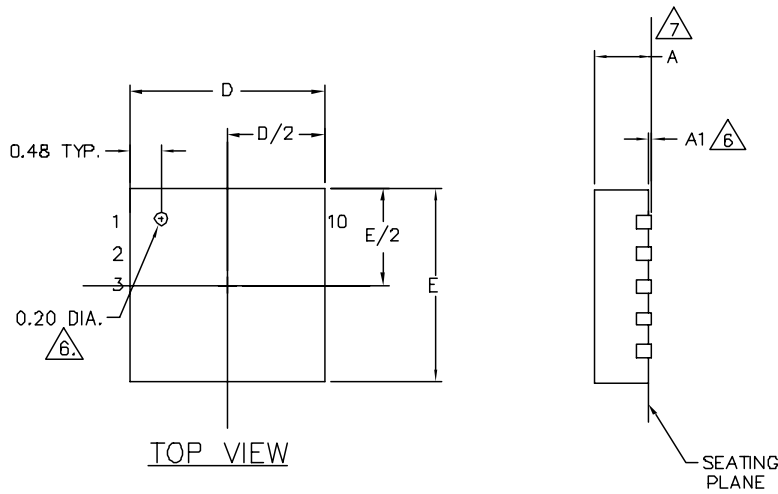

	DIMENSION (mm)		
	MIN.	NOM.	MAX.
A	0.80	0.85	1.00
A1	0.00	0.01	0.05
D	3.00 BSC		
D2	1.45	1.60	1.75
E	3.00 BSC		
E2	2.15	2.30	2.45
e	0.50 BSC		
L	0.35	0.40	0.55
b	0.18	0.23	0.30

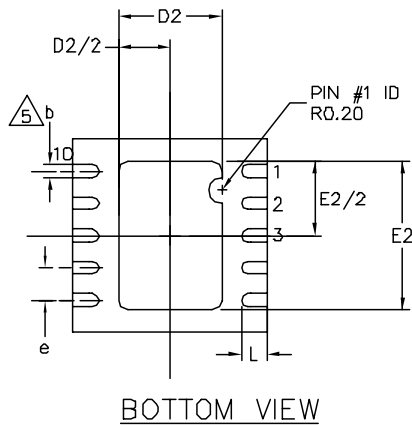

- NOTE:
1. ALL DIMENSIONS ARE IN MILLIMETERS.
 2. MAX. PACKAGE WARPAGE IS 0.05 mm.
 3. MAXIMUM ALLOWABLE BURRS IS 0.076 mm IN ALL DIRECTIONS.
 4. PIN #1 ID ON TOP WILL BE LASER/INK MARKED.
- ⚠ DIMENSION b APPLIES TO METALIZED TERMINAL AND IS MEASURED BETWEEN 0.20 AND 0.25 mm FROM TERMINAL TIP.
- ⚠ APPLIED ONLY FOR TERMINALS.
- ⚠ APPLIED FOR EXPOSED PAD AND TERMINALS.

10-Pin 3x3 MLF (MLF)

MICREL, INC. 2180 FORTUNE DRIVE SAN JOSE, CA 95131 USA
 TEL +1 (408) 944-0800 FAX +1 (408) 474-1000 WEB <http://www.micrel.com>

The information furnished by Micrel in this data sheet is believed to be accurate and reliable. However, no responsibility is assumed by Micrel for its use. Micrel reserves the right to change circuitry and specifications at any time without notification to the customer.

Micrel Products are not designed or authorized for use as components in life support appliances, devices or systems where malfunction of a product can reasonably be expected to result in personal injury. Life support devices or systems are devices or systems that (a) are intended for surgical implant into the body or (b) support or sustain life, and whose failure to perform can be reasonably expected to result in a significant injury to the user. A Purchaser's use or sale of Micrel Products for use in life support appliances, devices or systems is a Purchaser's own risk and Purchaser agrees to fully indemnify Micrel for any damages resulting from such use or sale.

© 2004 Micrel, Incorporated.