

TLE42694

Low Dropout Fixed Voltage Regulator

Automotive Power



Never stop thinking



1 Overview

Features

- Output Voltage 5 V \pm 2%
- Output Current up to 150 mA
- Very Low Current Consumption
- Early Warning
- Power-on and Undervoltage Reset with Programmable Delay Time
- Reset Low Down to $V_Q = 1$ V
- Adjustable Reset Threshold
- Very Low Dropout Voltage
- Output Current Limitation
- Reverse Polarity Protection
- Overtemperature Protection
- Suitable for Use in Automotive Electronics
- Wide Temperature Range from -40 °C up to 150 °C
- Input Voltage Range from -42 V to 45 V
- Integrated Pull-Up Resistors at Logic Outputs
- Green Product (RoHS compliant)
- AEC Qualified

Description

The TLE 42694 is a monolithic integrated low dropout voltage regulator, especially designed for automotive applications. An input voltage up to 45 V is regulated to an output voltage of 5.0 V. The component is able to drive loads up to 150 mA. It is short-circuit proof by the implemented output current limitation and has an integrated overtemperature shutdown. A reset signal is generated for an output voltage $V_{Q,rt}$ of typically 4.65 V. This threshold can be decreased by an external resistor divider. The power-on reset delay time can be programmed by the external delay capacitor. The additional sense comparator provides an early warning function: Any voltage (e.g. the input voltage) can be monitored, an under-voltage condition is indicated by setting the comparator's output to low. The reset and sense output are internally connected to the output Q via a pull-up resistor. If these integrated resistors are not desired, the TLE42794 can be used instead of the TLE42694.

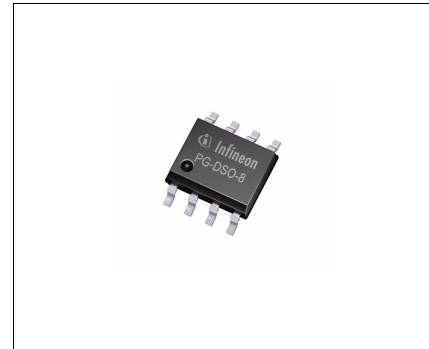

PG-DSO-8

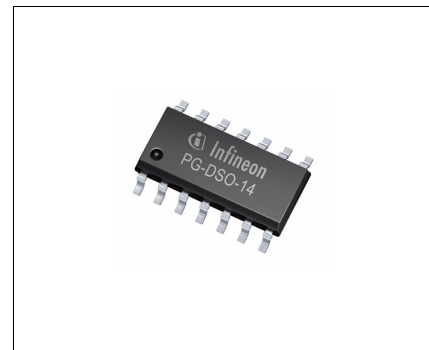

PG-DSO-14

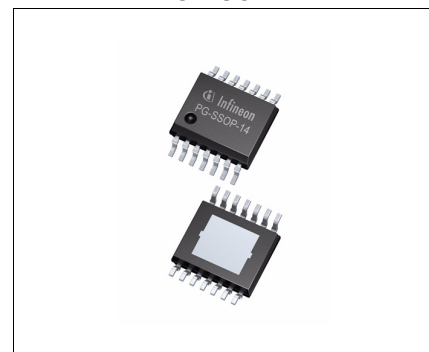

PG-SSOP-14 exposed pad

Type	Package	Marking
TLE42694G	PG-DSO-8	42694G
TLE42694GM	PG-DSO-14	42694GM
TLE42694E	PG-SSOP-14 exposed pad	42694E

Dimensioning Information on External Components

The input capacitor C_i is recommended for compensation of line influences. The output capacitor C_o is necessary for the stability of the control loop.

Circuit Description

The control amplifier compares a reference voltage to a voltage that is proportional to the output voltage and drives the base of the series transistor via a buffer. Saturation control as a function of the load current prevents any oversaturation of the power element. The component also has a number of internal circuits for protection against:

- Overload
- Overtemperature
- Reverse polarity

2 Block Diagram

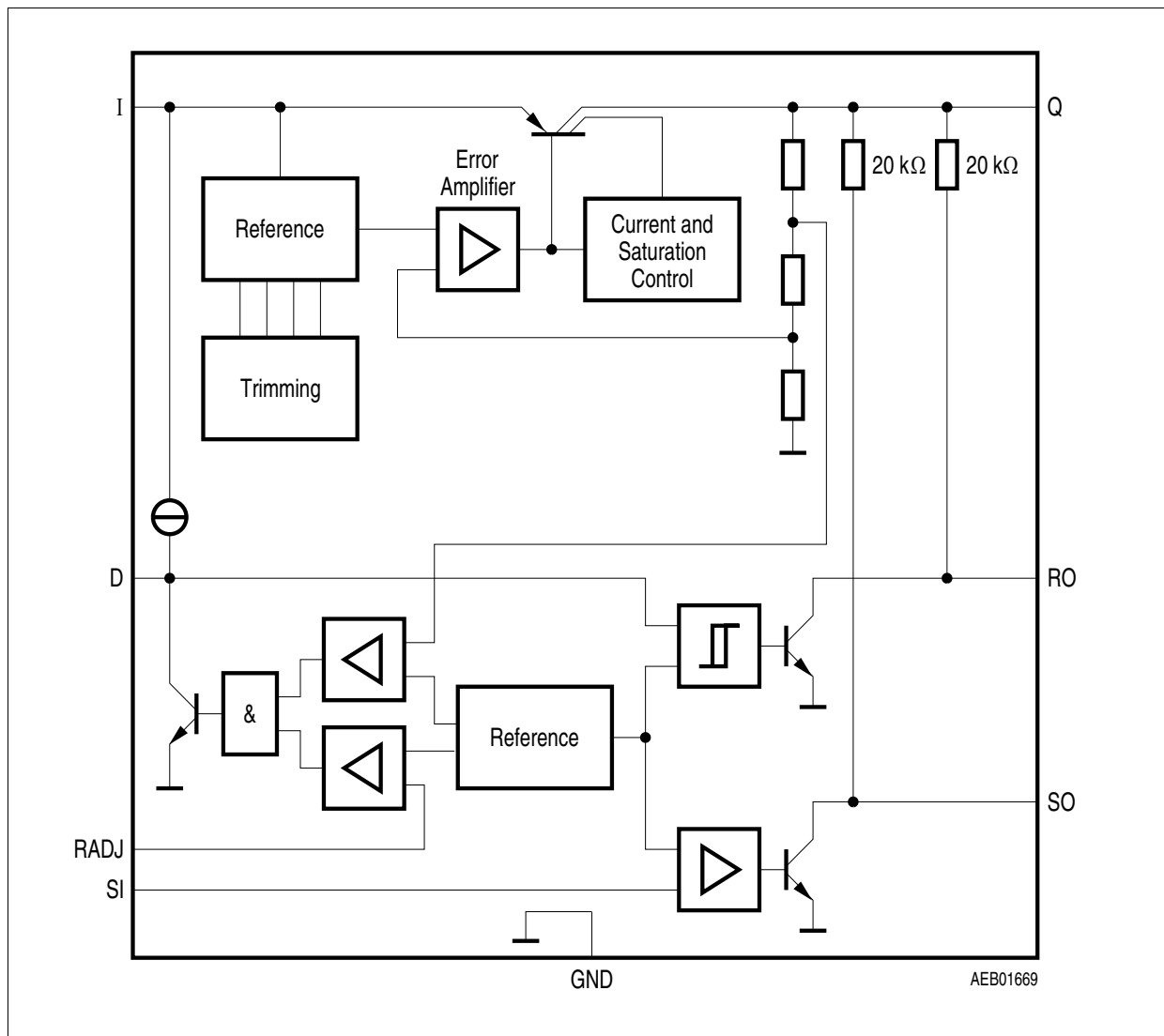

Figure 1 Block Diagram

3 Pin Configuration

3.1 Pin Assignment PG-DSO-8

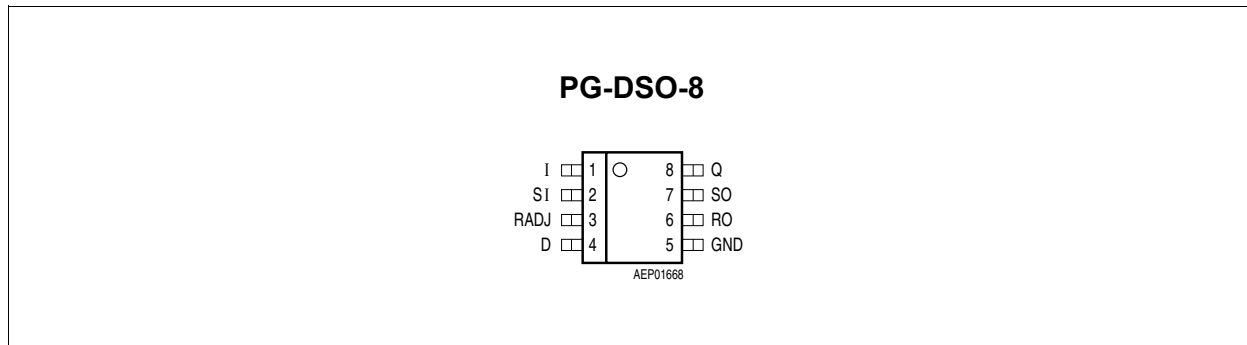

Figure 2 Pin Configuration (top view)

3.2 Pin Definitions and Functions PG-DSO-8

Table 1

Pin	Symbol	Function
1	I	Input for compensating line influences, a capacitor to GND close to the IC terminals is recommended
2	SI	Sense Input connect the voltage to be monitored; connect to Q if the sense comparator is not needed
3	RADJ	Reset Threshold Adjust connect an external voltage divider to adjust reset threshold; connect to GND for using internal threshold
4	D	Reset Delay Timing connect a ceramic capacitor to GND for adjusting the reset delay time; leave open if the reset function is not needed
5	GND	Ground
6	RO	Reset Output open collector output; internally linked to the output via a 20kΩ pull-up resistor; leave open if the reset function is not needed
7	SO	Sense Output open collector output; internally linked to the output via a 20kΩ pull-up resistor; leave open if the sense comparator is not needed
8	Q	Output block to GND with a capacitor close to the IC terminals, respecting the values given for its capacitance C_Q and ESR in “Functional Range” on Page 9

3.3 Pin Assignment PG-DSO-14

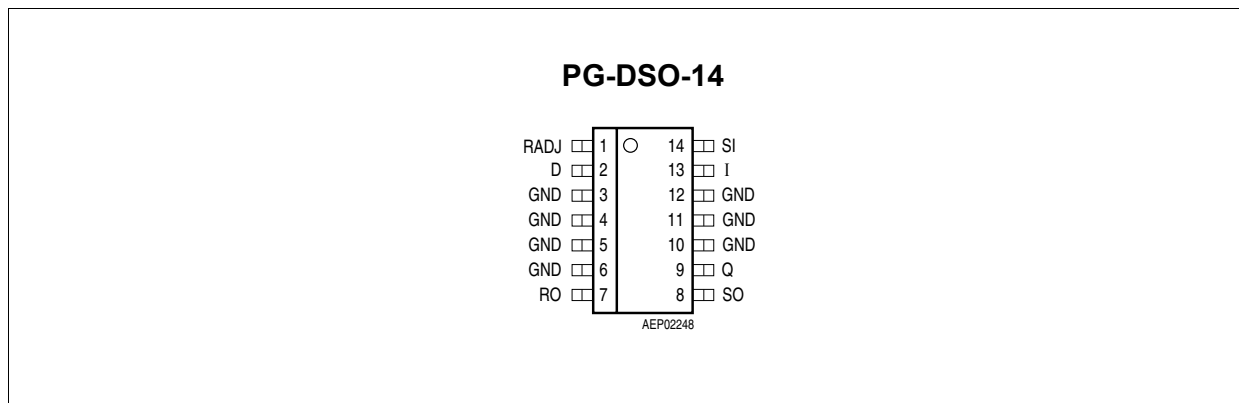

Figure 3 Pin Configuration (top view)

3.4 Pin Definitions and Functions PG-DSO-14

Table 2

Pin	Symbol	Function
1	RADJ	Reset Threshold Adjust connect an external voltage divider to adjust reset threshold; connect to GND for using internal threshold
2	D	Reset Delay Timing connect a ceramic capacitor to GND for adjusting the reset delay time; leave open if the reset function is not needed
3, 4, 5, 6	GND	Ground all pins must be connected to GND
7	RO	Reset Output open collector output; internally linked to the output via a 20kΩ pull-up resistor; leave open if the reset function is not needed
8	SO	Sense Output open collector output; internally linked to the output via a 20kΩ pull-up resistor; leave open if the sense comparator is not needed
9	Q	Output block to GND with a capacitor close to the IC terminals, respecting the values given for its capacitance C_Q and ESR in the table “Functional Range” on Page 9
10, 11, 12	GND	Ground all pins must be connected to GND
13	I	Input for compensating line influences, a capacitor to GND close to the IC terminals is recommended
14	SI	Sense Input connect the voltage to be monitored; connect to Q if the sense comparator is not needed

3.5 Pin Assignment PG-SSOP-14 exposed pad

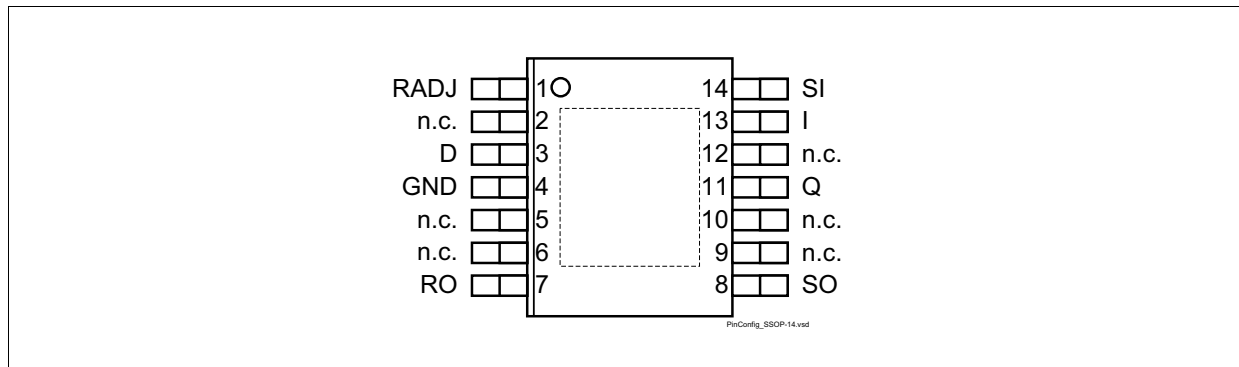

Figure 4 Pin Configuration (top view)

3.6 Pin Definitions and Functions PG-SSOP-14 exposed pad

Table 3

Pin	Symbol	Function
1	RADJ	Reset Threshold Adjust connect an external voltage divider to adjust reset threshold; connect to GND for using internal threshold
2, 5, 6	n.c.	not connected
3	D	Reset Delay Timing connect a ceramic capacitor to GND for adjusting the reset delay time; leave open if the reset function is not needed
4	GND	Ground all pins must be connected to GND
7	RO	Reset Output open collector output; internally linked to the output via a 20kΩ pull-up resistor; leave open if the reset function is not needed
8	SO	Sense Output open collector output; internally linked to the output via a 20kΩ pull-up resistor; leave open if the sense comparator is not needed
9, 10, 12	n.c.	not connected
11	Q	Output block to GND with a capacitor close to the IC terminals, respecting the values given for its capacitance C_Q and ESR in the table “Functional Range” on Page 7
13	I	Input for compensating line influences, a capacitor to GND close to the IC terminals is recommended
14	SI	Sense Input connect the voltage to be monitored; connect to Q if the sense comparator is not needed
Pad	-	Exposed Pad connect to heatsink area; connect to GND

4 General Product Characteristics

4.1 Absolute Maximum Ratings

Absolute Maximum Ratings ¹⁾

-40 °C ≤ T_j ≤ 150 °C; all voltages with respect to ground, positive current flowing into pin (unless otherwise specified)

Pos.	Parameter	Symbol	Limit Values		Unit	Conditions
			Min.	Max.		
Input, Sense Input						
4.1.1	Voltage	V _I , V _{SI}	-40	45	V	–
Output, Reset Output, Sense Output, Reset Delay						
4.1.2	Voltage	V _Q , V _{RO} , V _{SO} , V _D	-0.3	7	V	–
Reset Threshold						
4.1.3	Voltage	V _{RADJ}	-0.3	7	V	–
4.1.4	Current	I _{RADJ}	-10	10	mA	–
Temperature						
4.1.5	Junction Temperature	T _j	-40	150	°C	–
4.1.6	Storage Temperature	T _{stg}	-50	150	°C	–
ESD Susceptibility						
4.1.7	Human Body Model (HBM) ²⁾	Voltage	-2	2	kV	–
4.1.8	Charged Device Model (CDM) ³⁾	Voltage	-1	1	kV	–

1) not subject to production test, specified by design

2) ESD HBM Test according to AEC-Q100-002 - JESD22-A114

3) ESD CDM Test according to ESDA ESD-STM5.3.1

Note: Maximum ratings are absolute ratings; exceeding any one of these values may cause irreversible damage to the integrated circuit. Integrated protection functions are designed to prevent IC destruction under fault conditions. Fault conditions are considered as outside normal operating range. Protection functions are not designed for continuous repetitive operation.

4.2 Functional Range

Pos.	Parameter	Symbol	Limit Values		Unit	Conditions
			Min.	Max.		
4.2.1	Input Voltage	V_I	5.5	45	V	–
4.2.2	Output Capacitor's Requirements for Stability	C_Q	10	–	μF	– ¹⁾
		$ESR(C_Q)$	–	3	Ω	– ²⁾
4.2.3	Junction Temperature	T_j	-40	150	$^{\circ}\text{C}$	–

1) the minimum output capacitance requirement is applicable for a worst case capacitance tolerance of 30%

2) relevant ESR value at $f = 10$ kHz

Note: Within the functional range the IC operates as described in the circuit description. The electrical characteristics are specified within the conditions given in the related electrical characteristics table.

4.3 Thermal Resistance

Pos.	Parameter	Symbol	Limit Value			Unit	Conditions
			Min.	Typ.	Max.		
TLE42694G (PG-DSO-8)							
4.3.4	Junction to Soldering Point ¹⁾	R_{thJSP}	–	80	–	K/W	measured to pin 5
4.3.5	Junction to Ambient ¹⁾	R_{thJA}	–	113	–	K/W	²⁾
4.3.6			–	170	–	K/W	Footprint only ³⁾
4.3.7			–	142	–	K/W	300mm ² heatsink area on PCB ³⁾
4.3.8			–	136	–	K/W	600mm ² heatsink area on PCB ³⁾
TLE42694GM (PG-DSO-14)							
4.3.9	Junction to Soldering Point ¹⁾	R_{thJSP}	–	27	–	K/W	measured to group of pins 3, 4, 5, 10, 11, 12
4.3.10	Junction to Ambient ¹⁾	R_{thJA}	–	63	–	K/W	²⁾
4.3.11			–	104	–	K/W	Footprint only ³⁾
4.3.12			–	73	–	K/W	300mm ² heatsink area on PCB ³⁾
4.3.13			–	65	–	K/W	600mm ² heatsink area on PCB ³⁾
TLE42694E (PG-SSOP-14 exposed pad)							
4.3.14	Junction to Soldering Point ¹⁾	R_{thJSP}	–	10	–	K/W	measured to pin 5
4.3.15	Junction to Ambient ¹⁾	R_{thJA}	–	47	–		²⁾
4.3.16			–	145	–	K/W	Footprint only ³⁾
4.3.17			–	63	–	K/W	300mm ² heatsink area on PCB ³⁾
4.3.18			–	53	–	K/W	600mm ² heatsink area on PCB ³⁾

1) not subject to production test, specified by design

2) Specified R_{thJA} value is according to Jedec JESD51-2,-5,-7 at natural convection on FR4 2s2p board; The Product (Chip+Package) was simulated on a 76.2 x 114.3 x 1.5 mm³ board with 2 inner copper layers (2 x 70µm Cu, 2 x 35µm Cu). Where applicable a thermal via array under the exposed pad contacted the first inner copper layer.

3) Specified R_{thJA} value is according to JEDEC JESD 51-3 at natural convection on FR4 1s0p board; The Product (Chip+Package) was simulated on a 76.2 x 114.3 x 1.5 mm³ board with 1 copper layer (1 x 70µm Cu).

5 Block Description and Electrical Characteristics

5.1 Voltage Regulator

The output voltage V_Q is controlled by comparing a portion of it to an internal reference and driving a PNP pass transistor accordingly. The control loop stability depends on the output capacitor C_Q , the load current, the chip temperature and the poles/zeros introduced by the integrated circuit. To ensure stable operation, the output capacitor's capacitance and its equivalent series resistor ESR requirements given in the table “**Functional Range**” on Page 9 have to be maintained. For details see also the typical performance graph “**Output Capacitor Series Resistor ESR(C_Q) versus Output Current I_Q** ” on Page 14. As the output capacitor also has to buffer load steps it should be sized according to the application's needs.

An input capacitor C_I is strongly recommended to compensate line influences. Connect the capacitors close to the component's terminals.

A protection circuitry prevents the IC as well as the application from destruction in case of catastrophic events. These safeguards contain an output current limitation, a reverse polarity protection as well as a thermal shutdown in case of overtemperature.

In order to avoid excessive power dissipation that could never be handled by the pass element and the package, the maximum output current is decreased at input voltages above $V_I = 22$ V.

The thermal shutdown circuit prevents the IC from immediate destruction under fault conditions (e.g. output continuously short-circuited) by switching off the power stage. After the chip has cooled down, the regulator restarts. This leads to an oscillatory behaviour of the output voltage until the fault is removed. However, junction temperatures above 150 °C are outside the maximum ratings and therefore significantly reduce the IC's lifetime.

The TLE 42694 allows a negative supply voltage. In this fault condition, small currents are flowing into the IC, increasing its junction temperature. This has to be considered for the thermal design, respecting that the thermal protection circuit is not operating during reverse polarity conditions.

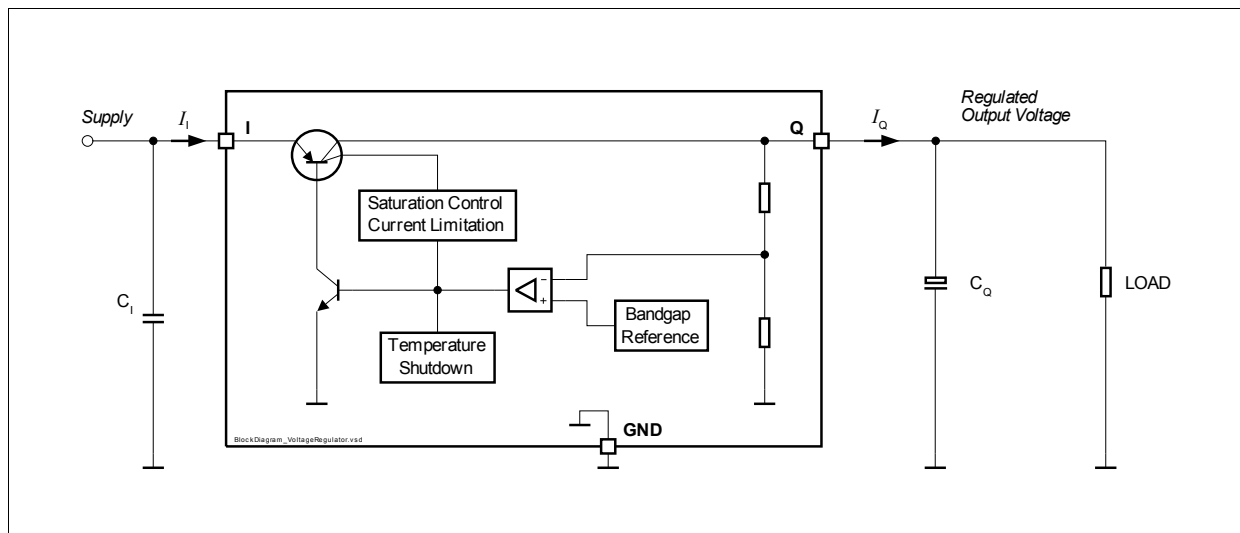

Figure 5 Voltage Regulator

Block Description and Electrical Characteristics
Electrical Characteristics Voltage Regulator

$V_I = 13.5 \text{ V}$, $-40 \text{ }^\circ\text{C} \leq T_j \leq 150 \text{ }^\circ\text{C}$, all voltages with respect to ground, positive current flowing into pin (unless otherwise specified)

Pos.	Parameter	Symbol	Limit Values			Unit	Conditions
			Min.	Typ.	Max.		
5.1.1	Output Voltage	V_Q	4.9	5.0	5.1	V	$100 \mu\text{A} < I_Q < 100 \text{ mA}$ $6 \text{ V} < V_I < 18 \text{ V}$
5.1.2	Output Current Limitation	$I_{Q,\text{max}}$	150	200	500	mA	$V_Q = 4.8 \text{ V}$
5.1.3	Load Regulation steady-state	$\Delta V_{Q,\text{load}}$	-30	-15	–	mV	$I_Q = 5 \text{ mA}$ to 100 mA $V_I = 6 \text{ V}$
5.1.4	Line Regulation steady-state	$\Delta V_{Q,\text{line}}$	–	10	40	mV	$V_I = 6 \text{ V}$ to 32 V $I_Q = 5 \text{ mA}$
5.1.5	Dropout Voltage ¹⁾ $V_{\text{dr}} = V_I - V_Q$	V_{dr}	–	250	500	mV	$I_Q = 100 \text{ mA}$
5.1.6	Overtemperature Shutdown Threshold	$T_{j,\text{sd}}$	151	–	200	$^\circ\text{C}$	T_j increasing ²⁾
5.1.7	Overtemperature Shutdown Threshold Hysteresis	$T_{j,\text{sdh}}$	–	15	–	$^\circ\text{C}$	T_j decreasing ²⁾
5.1.8	Power Supply Ripple Rejection ²⁾	$PSRR$	–	70	–	dB	$f_{\text{ripple}} = 100 \text{ Hz}$ $V_{\text{ripple}} = 0.5 \text{ Vpp}$

1) measured when the output voltage V_Q has dropped 100mV from the nominal value obtained at $V_I = 13.5 \text{ V}$

2) not subject to production test, specified by design

Typical Performance Characteristics Voltage Regulator

Output Voltage V_Q versus Junction Temperature T_j

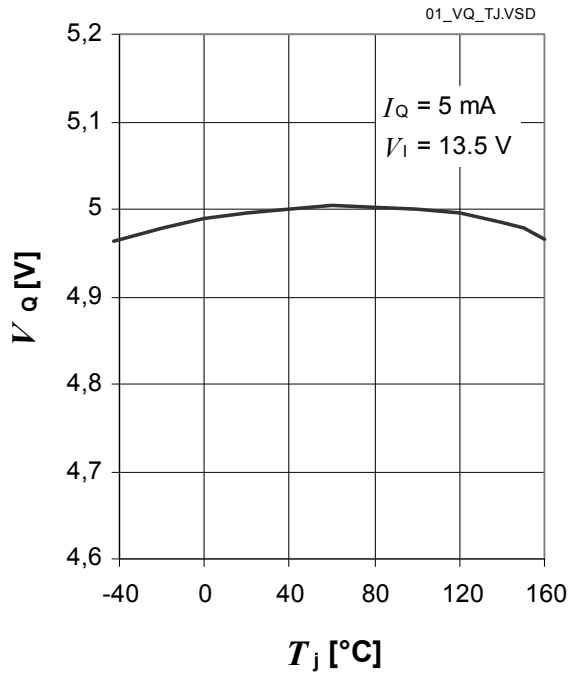

Output Current I_Q versus Input Voltage V_I

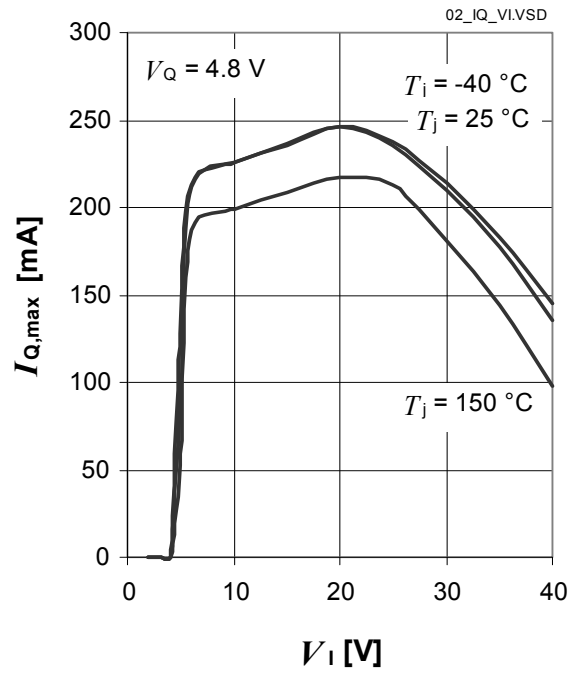

Power Supply Ripple Rejection $PSRR$ versus ripple frequency f_r

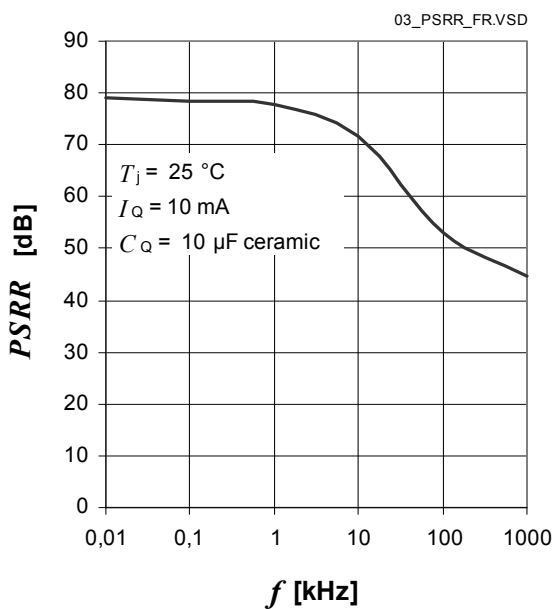

Line Regulation $\Delta V_{Q,line}$ versus Input Voltage Change ΔV_I

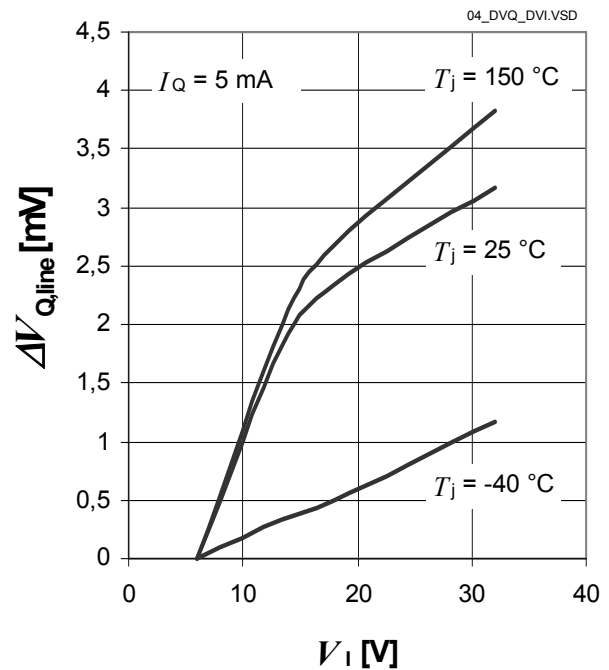

Typical Performance Characteristics Voltage Regulator

Load Regulation $\Delta V_{Q,load}$ versus Output Current Change ΔI_Q

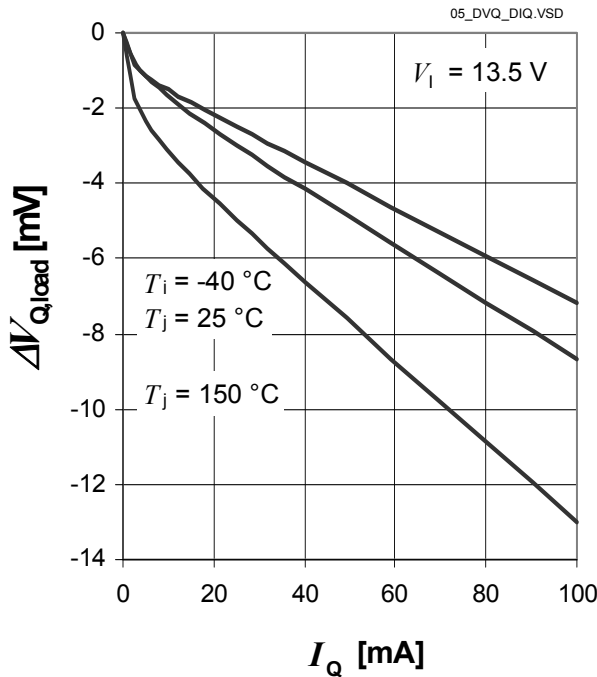

Output Capacitor Series Resistor $ESR(C_Q)$ versus Output Current I_Q

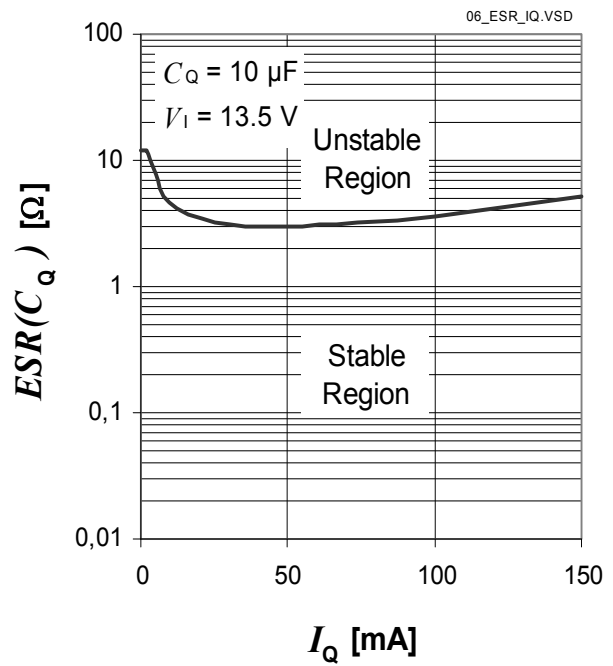

Dropout Voltage V_{dr} versus Output Current I_Q

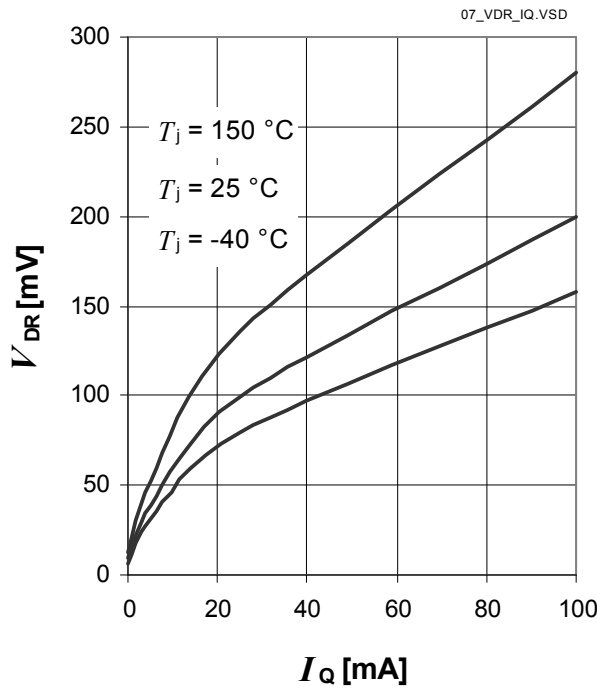

Dropout Voltage V_{dr} versus Junction Temperature T_j

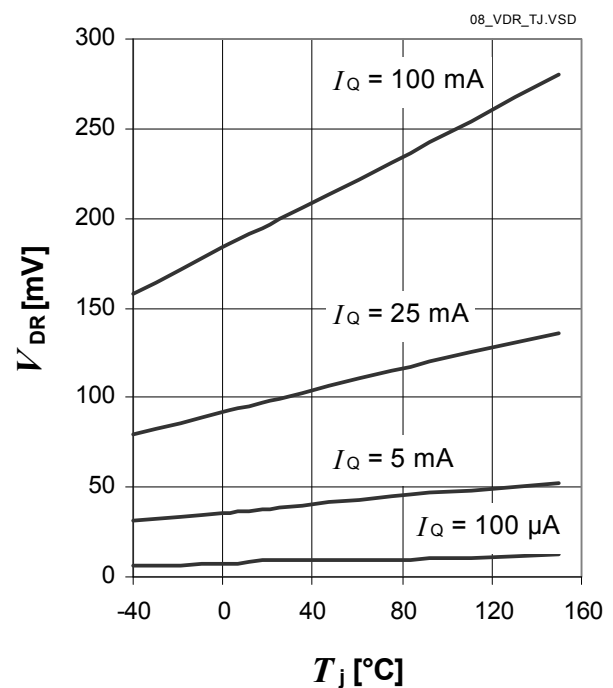

5.2 Current Consumption

Electrical Characteristics Current Consumption

$V_1 = 13.5\text{ V}$, $-40\text{ °C} \leq T_j \leq 150\text{ °C}$, positive current flowing into pin
(unless otherwise specified)

Pos.	Parameter	Symbol	Limit Values			Unit	Conditions
			Min.	Typ.	Max.		
5.2.1	Current Consumption $I_q = I_1 - I_Q$	I_q	–	210	280	μA	$I_Q = 100\ \mu\text{A}$ $T_j = 25\text{ °C}$
5.2.2			–	240	300	μA	$I_Q = 100\ \mu\text{A}$ $T_j \leq 85\text{ °C}$
5.2.3			–	0.7	1	mA	$I_Q = 10\ \text{mA}$
5.2.4			–	3.5	8	mA	$I_Q = 50\ \text{mA}$

Typical Performance Characteristics Current Consumption

Current Consumption I_q versus Output Current I_Q (I_Q low)

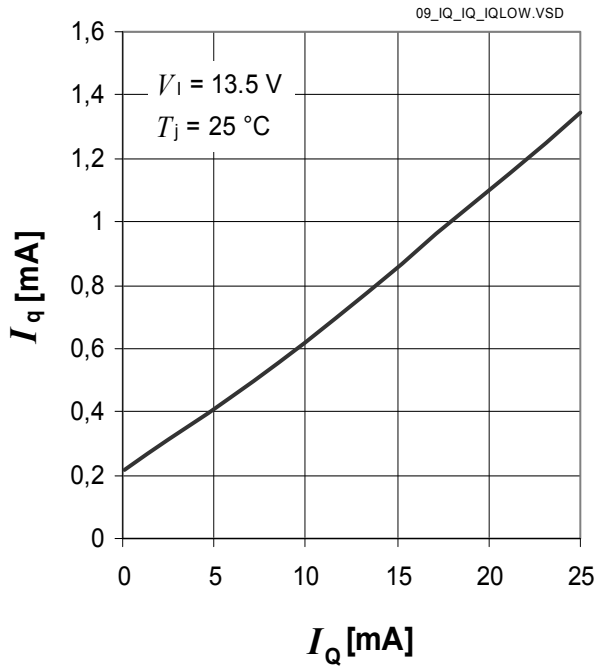

Current Consumption I_q versus Output Current I_Q

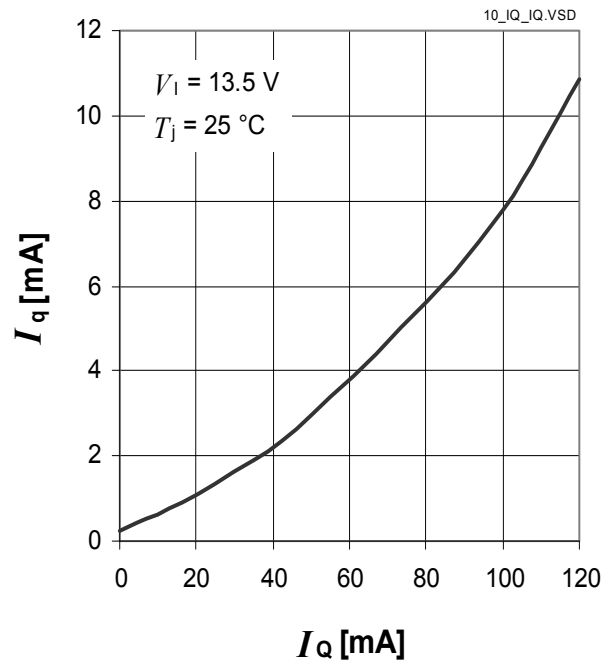

Current Consumption I_q versus Input Voltage V_1

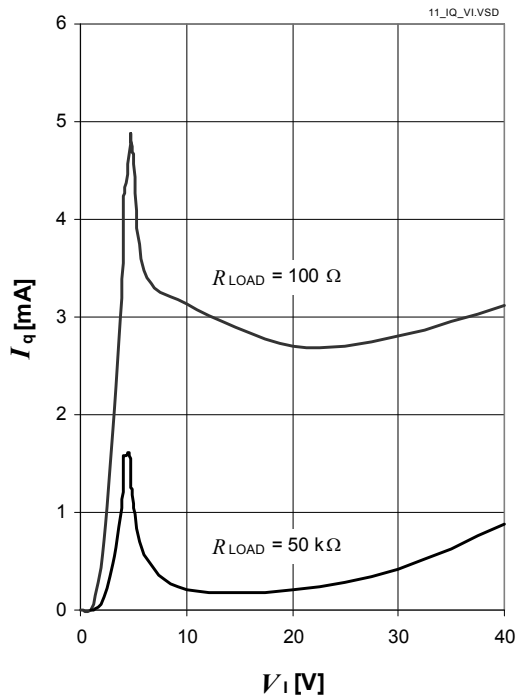

5.3 Reset Function

The reset function provides several features:

Output Undervoltage Reset:

An output undervoltage condition is indicated by setting the Reset Output RO to “low”. This signal might be used to reset a microcontroller during low supply voltage.

Power-On Reset Delay Time:

The power-on reset delay time t_{rd} allows a microcontroller and oscillator to start up. This delay time is the time frame from exceeding the reset switching threshold V_{RT} until the reset is released by switching the reset output “RO” from “low” to “high”. The power-on reset delay time t_{rd} is defined by an external delay capacitor C_D connected to pin D charged by the delay capacitor charge current $I_{D,ch}$ starting from $V_D = 0$ V.

If the application needs a power-on reset delay time t_{rd} different from the value given in [Item 5.3.8](#), the delay capacitor’s value can be derived from the specified values in [Item 5.3.8](#) and the desired power-on delay time:

$$C_D = \frac{t_{rd,new}}{t_{rd}} \times 100nF$$

with

- C_D : capacitance of the delay capacitor to be chosen
- $t_{rd,new}$: desired power-on reset delay time
- t_{rd} : power-on reset delay time specified in this datasheet

For a precise calculation also take the delay capacitor’s tolerance into consideration.

Reset Reaction Time:

The reset reaction time avoids that short undervoltage spikes trigger an unwanted reset “low” signal. The reset reaction time t_{rr} considers the internal reaction time $t_{rr,int}$ and the discharge time $t_{rr,d}$ defined by the external delay capacitor C_D (see typical performance graph for details). Hence, the total reset reaction time becomes:

$$t_{rr} = t_{rd,int} + t_{rr,d}$$

with

- t_{rr} : reset reaction time
- $t_{rr,int}$: internal reset reaction time
- $t_{rr,d}$: reset discharge

Optional Reset Output Pull-Up Resistor $R_{RO,ext}$:

The Reset Output RO is an open collector output with an integrated pull-up resistor. To improve the EMC behaviour of the component, an external pull-up resistor to the output V_Q can be added. In [Table “Electrical Characteristics Reset Function” on Page 21](#) a minimum value for the external resistor $R_{RO,ext}$ is given.

Reset Adjust Function

The undervoltage reset switching threshold can be adjusted according to the application's needs by connecting an external voltage divider (R_{ADJ1} , R_{ADJ2}) at pin RADJ. For selecting the default threshold connect pin RADJ to GND.

When dimensioning the voltage divider, take into consideration that there will be an additional current constantly flowing through the resistors.

With a voltage divider connected, the reset switching threshold $V_{RT,new}$ is calculated as follows:

$$V_{RT,new} = \frac{R_{ADJ,1} + R_{ADJ,2}}{R_{ADJ,2}} \times V_{RADJ,th}$$

with

- $V_{RT,new}$: the desired new reset switching threshold
- R_{ADJ1} , R_{ADJ2} : resistors of the external voltage divider
- $V_{RADJ,th}$: reset adjust switching threshold given in [Table "Electrical Characteristics Reset Function" on Page 21](#)

Block Description and Electrical Characteristics

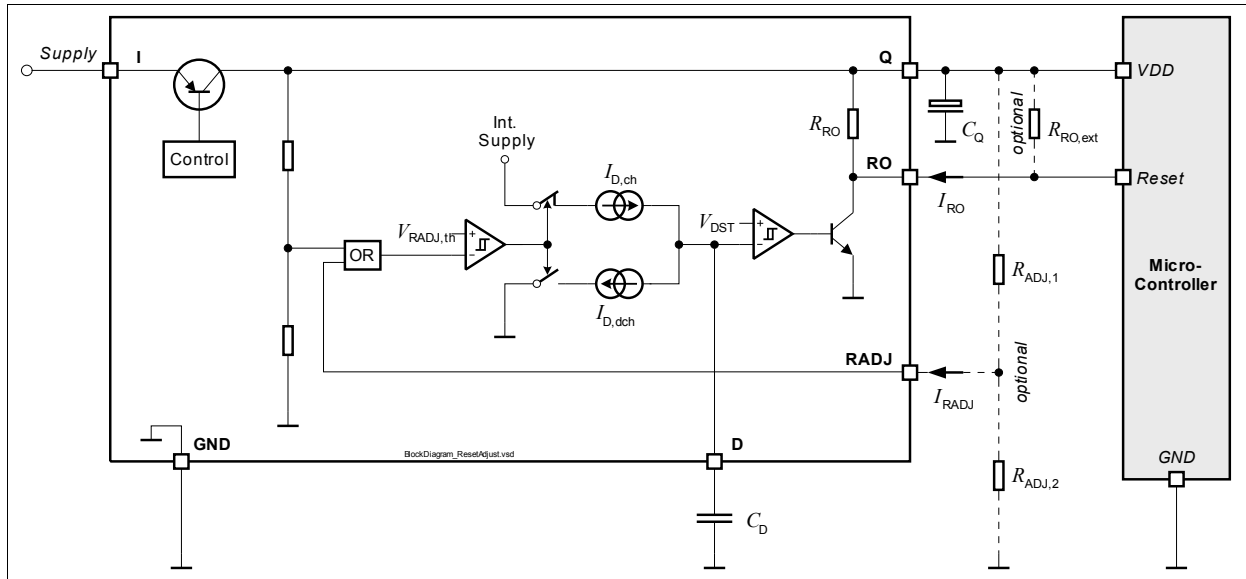

Figure 6 Block Diagram Reset Function

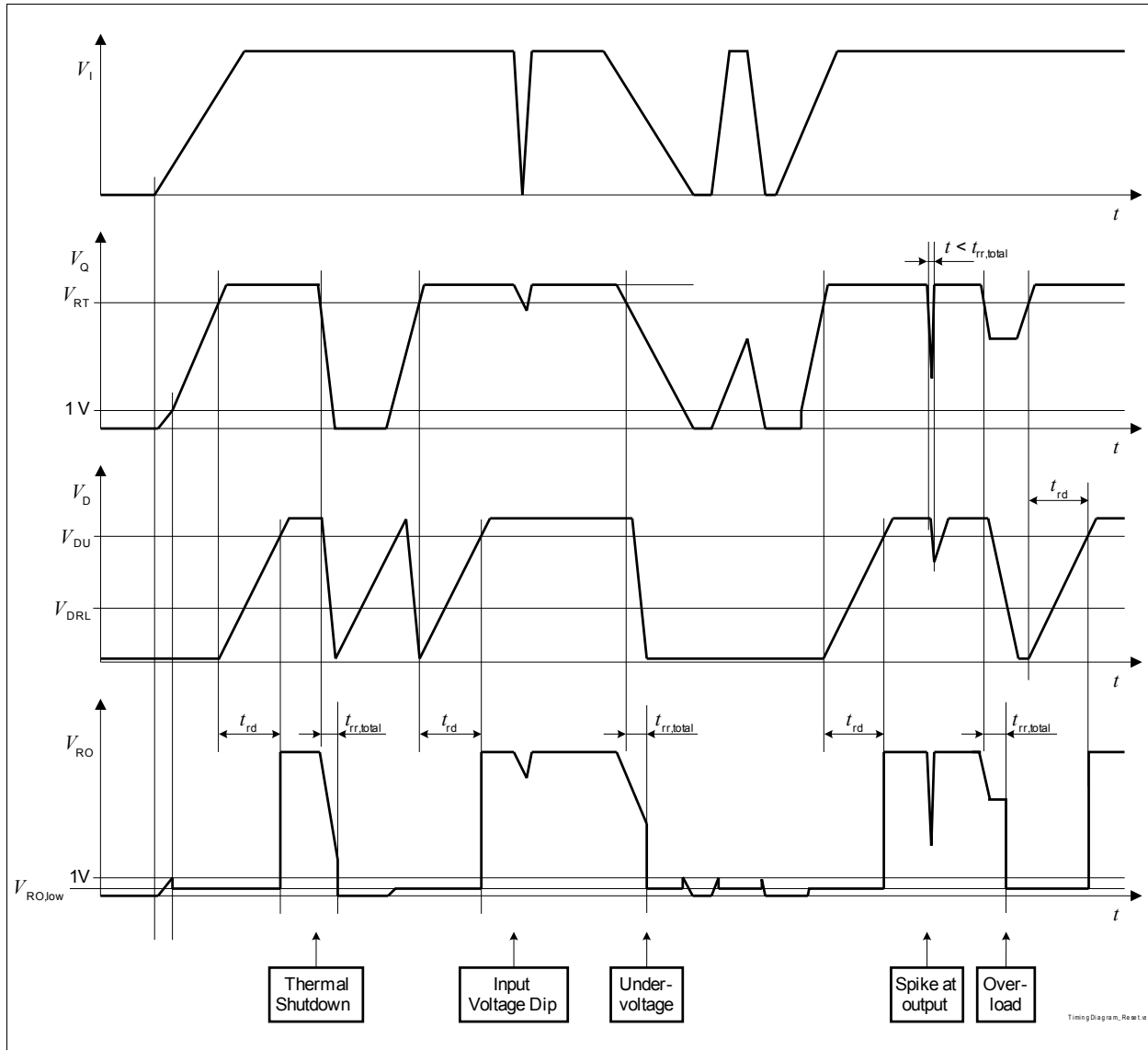

Figure 7 Timing Diagram Reset

Electrical Characteristics Reset Function

$V_I = 13.5 \text{ V}$, $-40 \text{ }^\circ\text{C} \leq T_j \leq 150 \text{ }^\circ\text{C}$, all voltages with respect to ground, positive current flowing into pin (unless otherwise specified)

Pos.	Parameter	Symbol	Limit Values			Unit	Conditions
			Min.	Typ.	Max.		
Output Undervoltage Reset							
5.3.1	Default Output Undervoltage Reset Switching Thresholds	V_{RT}	4.5	4.65	4.8	V	V_Q decreasing
Output Undervoltage Reset Threshold Adjustment							
5.3.2	Reset Adjust Switching Threshold	$V_{RADJ,th}$	1.26	1.35	1.44	V	$3.5 \text{ V} \leq V_Q < 5 \text{ V}$
5.3.3	Reset Adjustment Range ¹⁾	$V_{RT,range}$	3.50	–	4.65	V	–
Reset Output RO							
5.3.4	Reset Output Low Voltage	$V_{RO,low}$	–	0.1	0.4	V	$1 \text{ V} \leq V_Q \leq V_{RT}$ no external $R_{RO,ext}$
5.3.5	Reset Output Internal Pull-Up Resistor to V_Q	R_{RO}	10	20	40	k Ω	–
5.3.6	Optional Reset Output External Pull-up Resistor to V_Q	$R_{RO,ext}$	20	–	–	k Ω	$1 \text{ V} \leq V_Q \leq V_{RT}$; $V_{RO} \leq 0.4 \text{ V}$
Reset Delay Timing							
5.3.7	Delay Pin Output Voltage	V_D	–	–	5	V	–
5.3.8	Power On Reset Delay Time	t_{rd}	17	28	39	ms	$C_D = 100 \text{ nF}$
5.3.9	Upper Delay Switching Threshold	V_{DU}	–	1.8	–	V	–
5.3.10	Lower Delay Switching Threshold	V_{DL}	–	0.45	–	V	–
5.3.11	Delay Capacitor Charge Current	$I_{D,ch}$	–	6.5	–	μA	$V_D = 1 \text{ V}$
5.3.12	Delay Capacitor Reset Discharge Current	$I_{D,dch}$	–	70	–	mA	$V_D = 1 \text{ V}$
5.3.13	Delay Capacitor Discharge Time	$t_{rr,d}$	–	1.9	3	μs	Calculated Value: $t_{rr,d} = C_D \cdot (V_{DU} - V_{DL}) / I_{D,dch}$ $C_D = 100 \text{ nF}$
5.3.14	Internal Reset Reaction Time	$t_{rr,int}$	–	3	7	μs	$C_D = 0 \text{ nF}$ ²⁾
5.3.15	Reset Reaction Time	$t_{rr,total}$	–	4.9	10	μs	Calculated Value: $t_{rr,total} = t_{rr,int} + t_{rr,d}$ $C_D = 100 \text{ nF}$

1) V_{RT} is scaled linearly, in case the Reset Switching Threshold is modified

2) parameter not subject to production test; specified by design

Typical Performance Characteristics

Power On Reset Delay Time t_{rd} versus Junction Temperature T_j

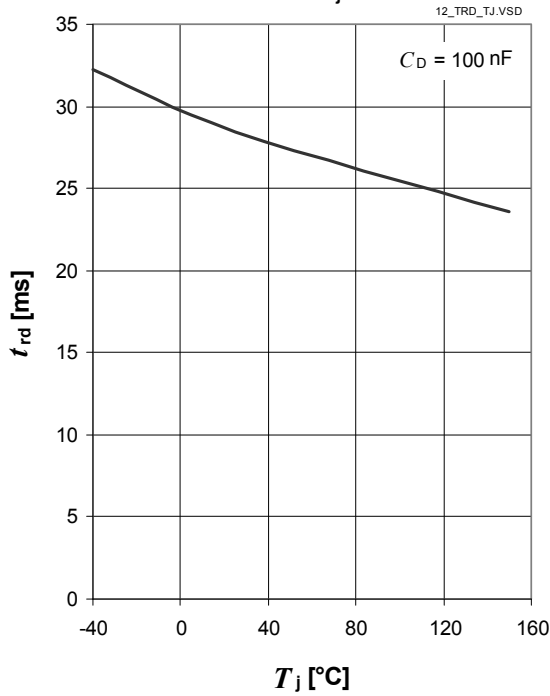

Power On Reset Delay Time t_{rd} versus Capacitance C_D

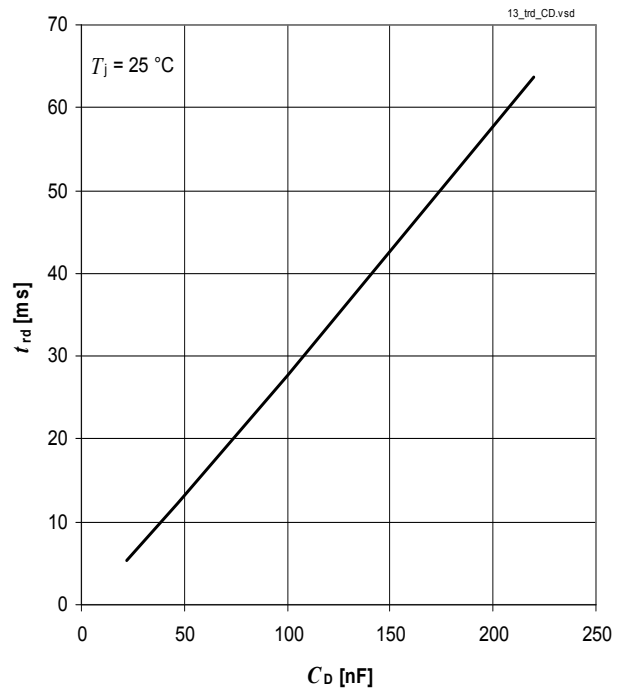

5.4 Early Warning Function

The additional sense comparator provides an early warning function: Any voltage (e.g. the input voltage) can be monitored, an undervoltage condition is indicated by setting the comparator's output to low.

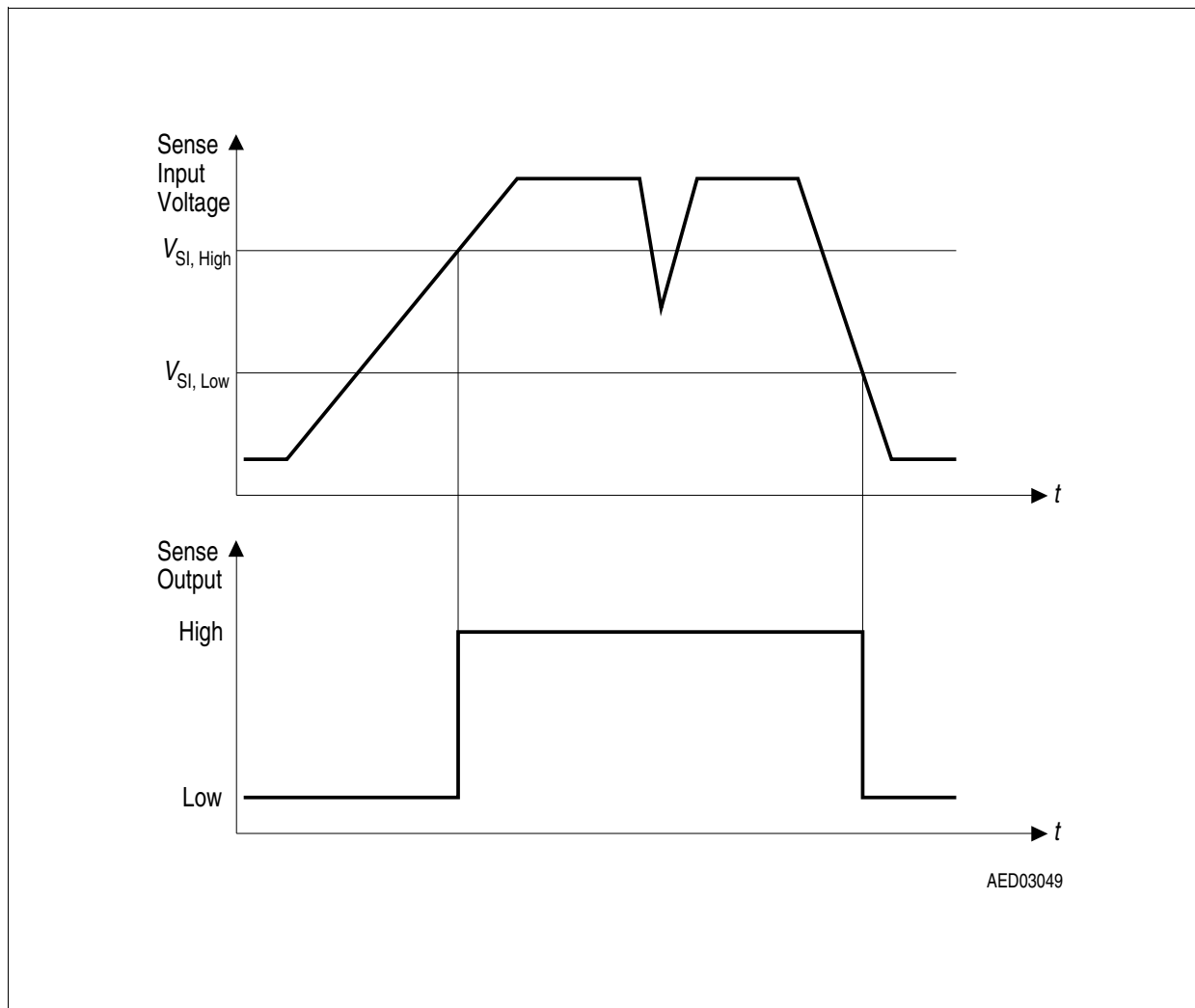

AED03049

Figure 8 Sense Timing Diagram

Electrical Characteristics Early Warning Function

$V_1 = 13.5 \text{ V}$, $-40 \text{ }^\circ\text{C} \leq T_j \leq 150 \text{ }^\circ\text{C}$, all voltages with respect to ground, positive current flowing into pin (unless otherwise specified)

Pos.	Parameter	Symbol	Limit Values			Unit	Conditions
			Min.	Typ.	Max.		
Sense Comparator Input							
5.4.1	Sense Threshold High	$V_{Sl,high}$	1.24	1.31	1.38	V	–
5.4.2	Sense Threshold Low	$V_{Sl,low}$	1.16	1.22	1.28	V	–
5.4.3	Sense Switching Hysteresis	$V_{Sl,hy}$	20	90	160	mV	–
5.4.4	Sense Input Current	I_{Sl}	-1	-0.1	1	μA	–

Block Description and Electrical Characteristics

Electrical Characteristics Early Warning Function

$V_1 = 13.5 \text{ V}$, $-40 \text{ }^\circ\text{C} \leq T_j \leq 150 \text{ }^\circ\text{C}$, all voltages with respect to ground, positive current flowing into pin (unless otherwise specified)

Pos.	Parameter	Symbol	Limit Values			Unit	Conditions
			Min.	Typ.	Max.		
Sense Comparator Output							
5.4.5	Sense Output Low Voltage	$V_{SO,low}$	–	0.1	0.4	V	$V_{SI} < V_{SI,low}$ $V_1 > 5.5 \text{ V}$ no external $R_{SO,ext}$
5.4.6	Sense Output Internal Pull-Up Resistor to V_Q	$R_{SO,int}$	10	20	40	k Ω	–
5.4.7	Optional Sense Output External Pull-up Resistor to V_Q	$R_{SO,ext}$	20	–	–	k Ω	$V_1 > 5.5 \text{ V}$ $V_{SO} \leq 0.4 \text{ V}$

6 Package Outlines

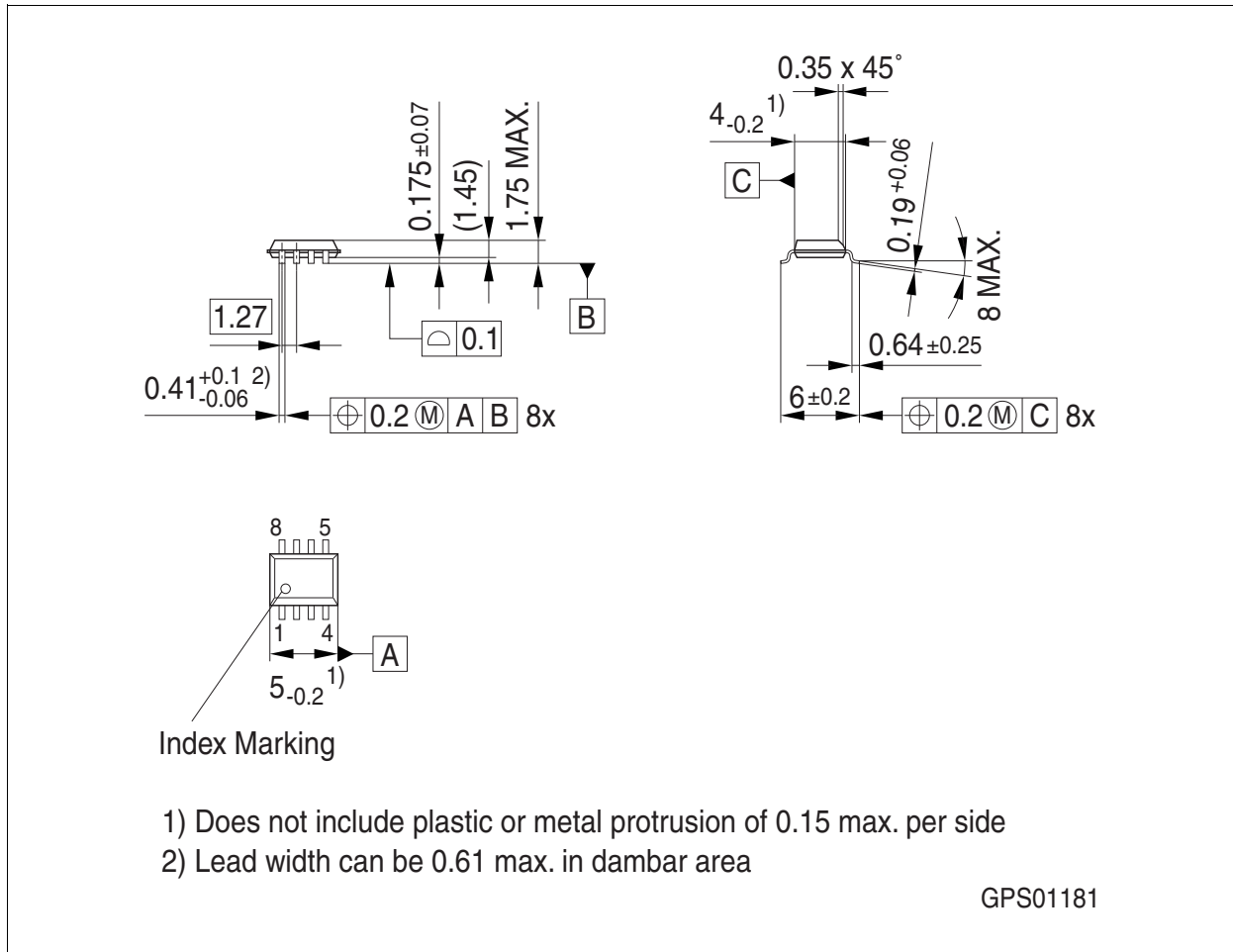

Figure 9 PG-DSO-8

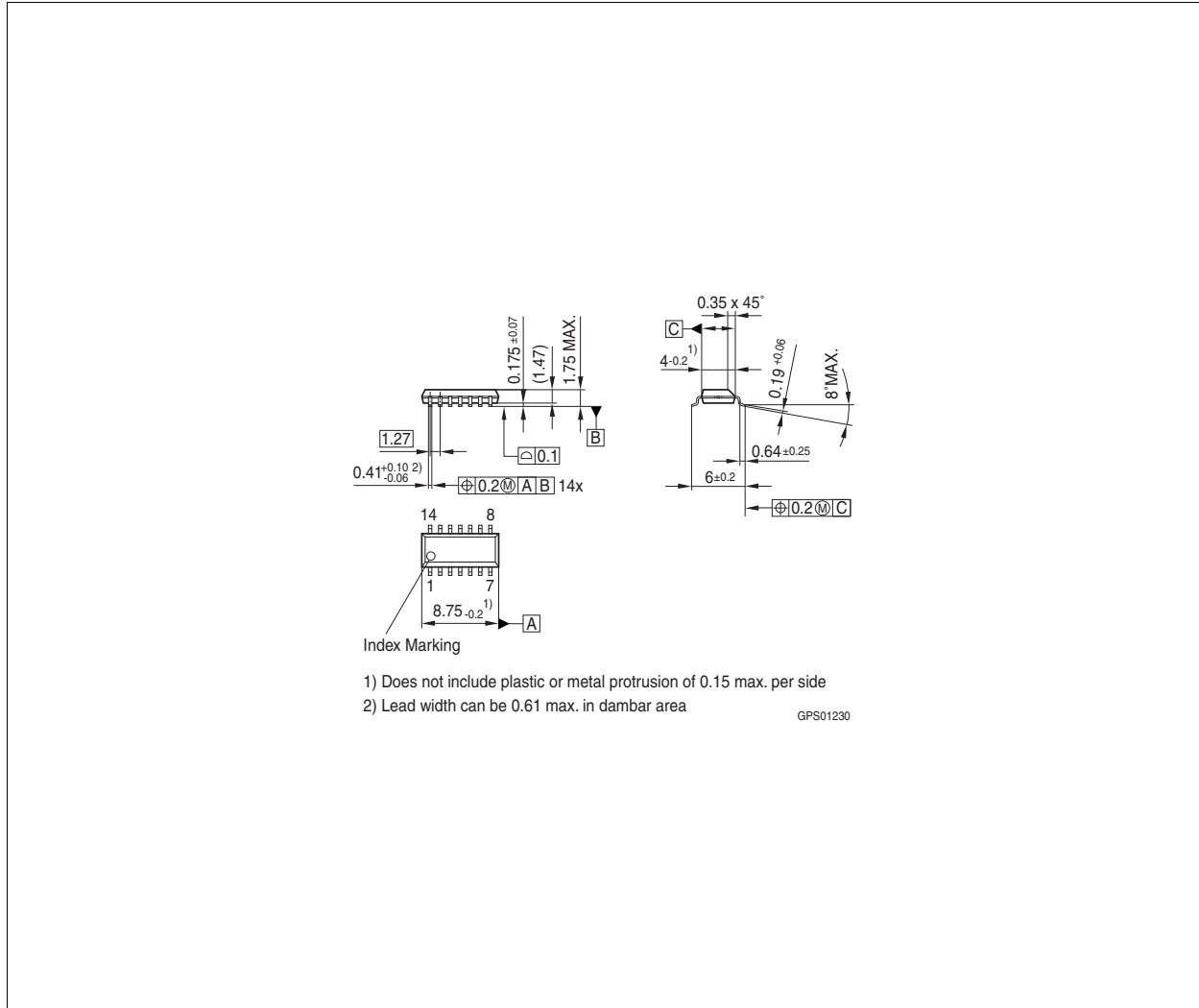

Figure 10 PG-DSO-14

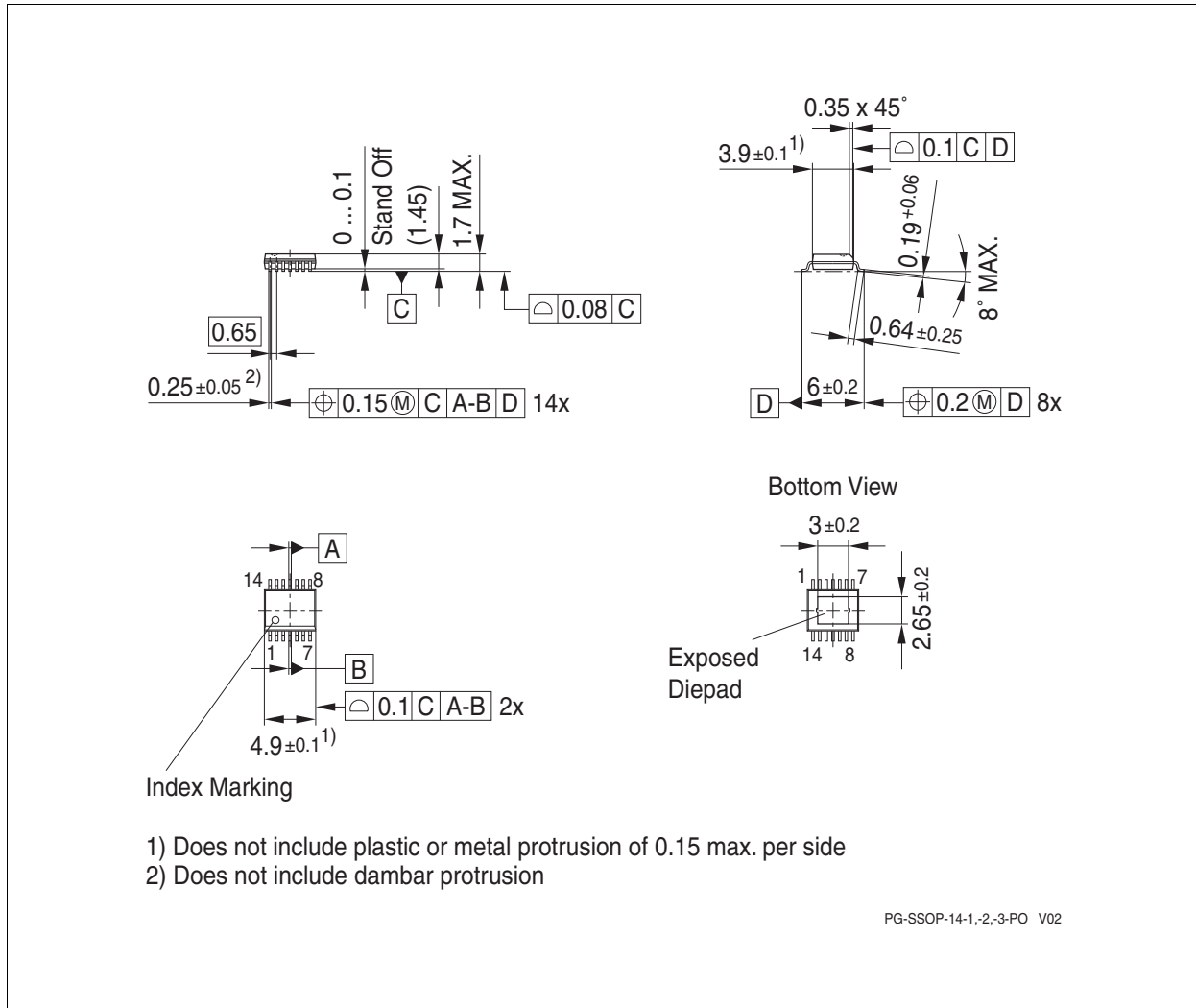

Figure 11 PG-SSOP-14 exposed pad

Green Product (RoHS compliant)

To meet the world-wide customer requirements for environmentally friendly products and to be compliant with government regulations the device is available as a green product. Green products are RoHS-Compliant (i.e Pb-free finish on leads and suitable for Pb-free soldering according to IPC/JEDEC J-STD-020).

You can find all of our packages, sorts of packing and others in our Infineon Internet Page "Products": <http://www.infineon.com/products>.

Dimensions in mm

7 Revision History

Revision	Date	Changes
1.2	2010-11-26	Updated PG-SSOP-14 Exposed Pad connection
1.1	2008-10-07	package version TLE42694E in PG-SSOP-14 exposed pad and all related information added In “Overview” on Page 2 package graphic for PG-SSOP-14 exposed pad and product name “TLE42694E” added In Chapter 3 “Pin Assignment PG-SSOP-14 exposed pad” on Page 7 and “Pin Definitions and Functions PG-SSOP-14 exposed pad” on Page 7 added In “Thermal Resistance” on Page 10 values for TLE42694E added In “Package Outlines” on Page 25 outlines for TLE4269E added
1.0	2008-08-25	initial version data sheet

Edition 2010-11-26

**Published by
Infineon Technologies AG
81726 Munich, Germany**

**© 2010 Infineon Technologies AG
All Rights Reserved.**

Legal Disclaimer

The information given in this document shall in no event be regarded as a guarantee of conditions or characteristics. With respect to any examples or hints given herein, any typical values stated herein and/or any information regarding the application of the device, Infineon Technologies hereby disclaims any and all warranties and liabilities of any kind, including without limitation, warranties of non-infringement of intellectual property rights of any third party.

Information

For further information on technology, delivery terms and conditions and prices, please contact the nearest Infineon Technologies Office (www.infineon.com).

Warnings

Due to technical requirements, components may contain dangerous substances. For information on the types in question, please contact the nearest Infineon Technologies Office.

Infineon Technologies components may be used in life-support devices or systems only with the express written approval of Infineon Technologies, if a failure of such components can reasonably be expected to cause the failure of that life-support device or system or to affect the safety or effectiveness of that device or system. Life support devices or systems are intended to be implanted in the human body or to support and/or maintain and sustain and/or protect human life. If they fail, it is reasonable to assume that the health of the user or other persons may be endangered.