

# LM3490

## 100 mA, SOT-23, Quasi Low-Dropout Linear Voltage Regulator with Logic-Controlled ON/OFF

### General Description

The LM3490 is an integrated linear voltage regulator. It features operation from an input as high as 30V and a guaranteed maximum dropout of 1.2V at the full 100 mA load. Standard packaging for the LM3490 is the 5-lead SOT-23 package. A logic-controlled ON/OFF feature makes the LM3490 ideal for powering subsystems ON and OFF as needed.

The 5, 12, and 15V members of the LM3490 series are intended as tiny alternatives to industry standard LM78LXX series and similar devices. The 1.2V quasi low dropout of LM3490 series devices makes them a nice fit in many applications where the 2 to 2.5V dropout of LM78LXX series devices precludes their (LM78LXX series devices) use.

The LM3490 series features a 3.3V member. The SOT packaging and quasi low dropout features of the LM3490 series converge in this device to provide a very nice, very tiny 3.3V, 100 mA bias supply that regulates directly off the system 5V  $\pm$ 5% power supply.

### Key Specifications

- 30V maximum input for operation
- 1.2V guaranteed maximum dropout over full load and temperature ranges
- 100 mA guaranteed load current
- $\pm$ 5% guaranteed output voltage tolerance over full load and temperature ranges
- -40 to +125°C junction temperature range for operation

### Features

- 3.3, 5, 12, and 15V versions available
- Logic-controlled ON/OFF
- Packaged in the tiny 5-lead SOT-23 package

### Applications

- Tiny alternative to LM78LXX series and similar devices
- Tiny 5V $\pm$ 5% to 3.3V, 100 mA converter
- Post regulator for switching DC/DC converter
- Bias supply for analog circuits

### Typical Application Circuit

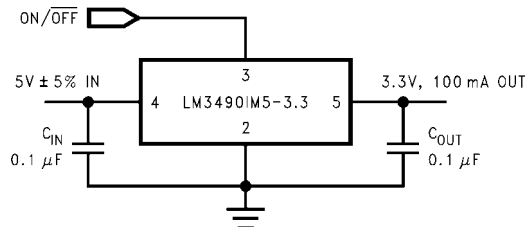

10007102

### Connection Diagram

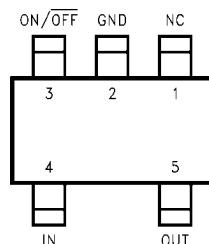

10007101

**Top View**  
**SOT-23 Package**  
**5-Lead, Molded-Plastic Small-Outline Transistor (SOT) Package**  
**Package Code MF05A (Note 1)**

## Ordering Information

Output Voltage (V)	Order Number (Note 2)	Package Marking (Note 3)	Comments
3.3	LM3490IM5-3.3	L78B	1000 Units on Tape and Reel
	LM3490IM5X-3.3	L78B	3000 Units on Tape and Reel
5.0	LM3490IM5-5.0	L79B	1000 Units on Tape and Reel
	LM3490IM5X-5.0	L79B	3000 Units on Tape and Reel
12	LM3490IM5-12	L80B	1000 Units on Tape and Reel
	LM3490IM5X-12	L80B	3000 Units on Tape and Reel
15	LM3490IM5-15	L81B	1000 Units on Tape and Reel
	LM3490IM5X-15	L81B	3000 Units on Tape and Reel

**Absolute Maximum Ratings** (Note 4)

If Military/Aerospace specified devices are required, please contact the National Semiconductor Sales Office/Distributors for availability and specifications.

Input Voltage (IN to GND)	35V
Voltage ON/OFF to GND	5.5V
Power Dissipation (Note 5)	400 mW
Junction Temp. (T <sub>J</sub> ) (Note 5)	+150°C
Ambient Storage Temp.	-65 to +150°C

Soldering Time, Temp. (Note 6)

Wave	4sec., 260°C
Infrared	10sec., 240°C
Vapor Phase	75sec., 219°C

ESD (Note 7)

ON/OFF	1.0kV
All Other Pins	2.0kV

**Operating Ratings** (Note 4)

Maximum Input Voltage (IN to GND)	30V
Voltage ON/OFF to GND	0 to 5V
Junction Temperature (T <sub>J</sub> )	-40 to +125°C
Maximum Power Dissipation (Note 8)	300 mW

**Electrical Characteristics****LM3490-3.3, LM3490-5.0**

V<sub>IN</sub> = V<sub>NOM</sub> + 1.5V unless otherwise noted. Typical and limits appearing in normal type apply for T<sub>A</sub> = T<sub>J</sub> = 25°C. Limits appearing in boldface type apply over the entire junction temperature range for operation, -40 to +125°C. (Notes 9, 10, 11)

Nominal Output Voltage (V <sub>NOM</sub> )			3.3V		5.0V		Units
Symbol	Parameter	Conditions	Typical	Limit	Typical	Limit	
V <sub>OUT</sub>	Output Voltage	1 mA ≤ I <sub>OUT</sub> ≤ 100 mA	3.30		5.00		V
				3.17		4.80	V(min)
				<b>3.14</b>		<b>4.75</b>	V(min)
				3.43		5.20	V(max)
				<b>3.46</b>		<b>5.25</b>	V(max)
ΔV <sub>OUT</sub>	Line Regulation	V <sub>NOM</sub> + 1.5V ≤ V <sub>IN</sub> ≤ 30V, I <sub>OUT</sub> = 1 mA	7		9		mV mV(max)
ΔV <sub>OUT</sub>	Load Regulation	10 mA ≤ I <sub>OUT</sub> ≤ 100 mA	15		15		mV mV(max)
I <sub>GND</sub>	Ground Pin Current	V <sub>NOM</sub> + 1.5V ≤ V <sub>IN</sub> ≤ 30V, No Load V <sub>ON/OFF</sub> = 5V	2		2		mA
				<b>4</b>		<b>4</b>	mA(max)
			V <sub>ON/OFF</sub> = 0V	0.1		0.1	
				<b>5</b>		<b>5</b>	μA(max)
V <sub>IN</sub> - V <sub>OUT</sub>	Dropout Voltage	I <sub>OUT</sub> = 10 mA	0.7		0.7		V
				0.9		0.9	V(max)
				<b>1.0</b>		<b>1.0</b>	V(max)
			I <sub>OUT</sub> = 100 mA	0.9		0.9	V
				1.1		1.1	V(max)
				<b>1.2</b>		<b>1.2</b>	V(max)
e <sub>n</sub>	Output Noise Voltage	V <sub>IN</sub> = 10V, Bandwidth: 10 Hz to 100 kHz	100		150		μV <sub>rms</sub>
V <sub>IL</sub>	Maximum Low Level Input Voltage at ON/OFF			<b>0.2</b>		<b>0.2</b>	V(max)
V <sub>IH</sub>	Minimum High Level Input Voltage at ON/OFF			<b>2.0</b>		<b>2.0</b>	V(min)
I <sub>IL</sub>		V <sub>ON/OFF</sub> = 0V		<b>-1</b>		<b>-1</b>	μA(max)
I <sub>IH</sub>		V <sub>ON/OFF</sub> = 5V	1		1		μA
				<b>20</b>		<b>20</b>	μA(max)

## LM3490-12, LM3490-15

$V_{IN} = V_{NOM} + 1.5V$  unless otherwise noted. Typical and limits appearing in normal type apply for  $T_A = T_J = 25^\circ C$ . Limits appearing in boldface type apply over the entire junction temperature range for operation,  $-40$  to  $+125^\circ C$ . (Notes 9, 10, 11)

Nominal Output Voltage ( $V_{NOM}$ )			12V		15V		Units
Symbol	Parameter	Conditions	Typical	Limit	Typical	Limit	
$V_{OUT}$	Output Voltage	$1\text{ mA} \leq I_{OUT} \leq 100\text{ mA}$	12.00	11.52 <b>11.40</b> 12.48 <b>12.60</b>	15.00	14.40 <b>14.25</b> 15.60 <b>15.75</b>	V V(min) V(min) V(max) V(max)
$\Delta V_{OUT}$	Line Regulation	$V_{NOM} + 1.5V \leq V_{IN} \leq 30V$ , $I_{OUT} = 1\text{ mA}$	14	<b>40</b>	16	<b>40</b>	mV mV(max)
$\Delta V_{OUT}$	Load Regulation	$10\text{ mA} \leq I_{OUT} \leq 100\text{ mA}$	36	<b>60</b>	45	<b>75</b>	mV mV(max)
$I_{GND}$	Ground Pin Current	$V_{NOM} + 1.5V \leq V_{IN} \leq 30V$ , No Load $V_{ON/OFF} = 5V$	2	<b>4</b>	2	<b>4</b>	mA mA(max)
		$V_{ON/OFF} = 0V$	0.1	<b>5</b>	0.1	<b>5</b>	$\mu A$ $\mu A$ (max)
$V_{IN} - V_{OUT}$	Dropout Voltage	$I_{OUT} = 10\text{ mA}$	0.7	0.9 <b>1.0</b>	0.7	0.9 <b>1.0</b>	V V(max) V(max)
		$I_{OUT} = 100\text{ mA}$	0.9	1.1 <b>1.2</b>	0.9	1.1 <b>1.2</b>	V V(max) V(max)
$e_n$	Output Noise Voltage	$V_{IN} = 10V$ , Bandwidth: 10 Hz to 100 kHz	360		450		$\mu V_{rms}$
$V_{IL}$	Maximum Low Level Input Voltage at ON/OFF			<b>0.2</b>		<b>0.2</b>	V(max)
$V_{IH}$	Minimum High Level Input Voltage at ON/OFF			<b>2.0</b>		<b>2.0</b>	V(min)
$I_{IL}$		$V_{ON/OFF} = 0V$		<b>-1</b>		<b>-1</b>	$\mu A$ (max)
$I_{IH}$		$V_{ON/OFF} = 5V$	1	<b>20</b>	1	<b>20</b>	$\mu A$ $\mu A$ (max)

**Note 1:** The package code MA05B is internal to National Semiconductor Corporation and indicates a specific version of the SOT-23 package and associated mechanical drawings.

**Note 2:** The suffix "I" indicates the junction temperature range for operation is the industrial temperature range,  $-40$  to  $+125^\circ C$ . The suffix "M5" indicates the die is packaged in the 5-lead SOT-23 package. The suffix "X" indicates the devices will be supplied in blocks of 3k units as opposed to blocks of 250 units.

**Note 3:** Because the entire part number does not fit on the SOT-23 package, the SOT-23 package is marked with this code instead of the part number.

**Note 4:** Absolute Maximum Ratings are limits beyond which damage to the device may occur. Operating Ratings are conditions under which operation of the device is guaranteed. Operating Ratings do not imply guaranteed performance limits. For guaranteed performance limits and associated test conditions, see the Electrical Characteristics tables.

**Note 5:** The Absolute Maximum power dissipation depends on the ambient temperature and can be calculated using  $P = (T_J - T_A)/\theta_{JA}$  where  $T_J$  is the junction temperature,  $T_A$  is the ambient temperature, and  $\theta_{JA}$  is the junction-to-ambient thermal resistance. The 400 mW rating results from substituting the Absolute Maximum junction temperature,  $150^\circ C$ , for  $T_J$ ,  $50^\circ C$  for  $T_A$ , and  $250^\circ C/W$  for  $\theta_{JA}$ . More power can be safely dissipated at lower ambient temperatures. Less power can be safely dissipated at higher ambient temperatures. The Absolute Maximum power dissipation can be increased by 4 mW for each  $^\circ C$  below  $50^\circ C$  ambient. It must be derated by 4 mW for each  $^\circ C$  above  $50^\circ C$  ambient. A  $\theta_{JA}$  of  $250^\circ C/W$  represents the worst-case condition of no heat sinking of the 5-lead plastic SOT-23 package. Heat sinking enables the safe dissipation of more power. The LM3490 actively limits its junction temperature to about  $150^\circ C$ .

**Note 6:** Times shown are dwell times. Temperatures shown are dwell temperatures. For detailed information on soldering plastic small-outline packages, refer to the *Packaging Databook* available from National Semiconductor Corporation.

**Note 7:** For testing purposes, ESD was applied using the human-body model, a 100 pF capacitor discharged through a 1.5 k $\Omega$  resistor.

**Note 8:** As with the Absolute Maximum power dissipation, the maximum power dissipation for operation depends on the ambient temperature. The 300 mW rating appearing under Operating Ratings results from substituting the maximum junction temperature for operation,  $125^\circ C$ , for  $T_J$ ,  $50^\circ C$  for  $T_A$ , and  $250^\circ C/W$  for  $\theta_{JA}$  in  $P = (T_J - T_A)/\theta_{JA}$ . More power can be dissipated at lower ambient temperatures. Less power can be dissipated at higher ambient temperatures. The maximum power dissipation for operation appearing under Operating Ratings can be increased by 4 mW for each  $^\circ C$  below  $50^\circ C$  ambient. It must be derated by 4 mW for

each °C above 50°C ambient. A  $\theta_{JA}$  of 250°C/W represents the worst-case condition of no heat sinking of the 5-lead plastic SOT-23 package. Heat sinking enables the dissipation of more power during operation.

**Note 9:** A typical is the center of characterization data taken with  $T_A = T_J = 25^\circ\text{C}$ . Typical values are not guaranteed.

**Note 10:** All limits are guaranteed. All electrical characteristics having room-temperature limits are tested during production with  $T_A = T_J = 25^\circ\text{C}$ . All hot and cold limits are guaranteed by correlating the electrical characteristics to process and temperature variations and applying statistical process control.

**Note 11:** All voltages except dropout are with respect to the voltage at the GND pin.

# Typical Performance Characteristics

Unless indicated otherwise,  $V_{IN} = V_{NOM} + 1.5V$ ,  $C_{IN} = 0.1 \mu F$ ,  $C_{OUT} = 0.1 \mu F$ , and  $T_A = 25^\circ C$ .

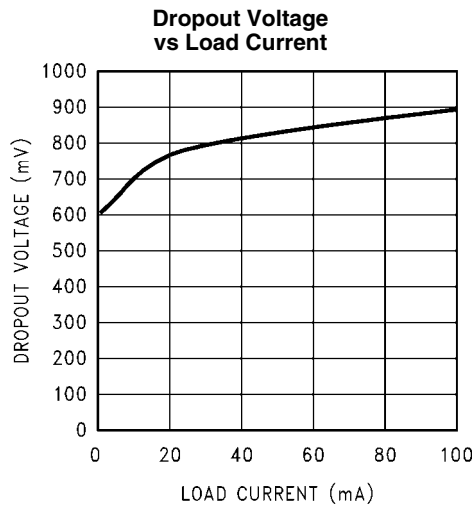

10007119

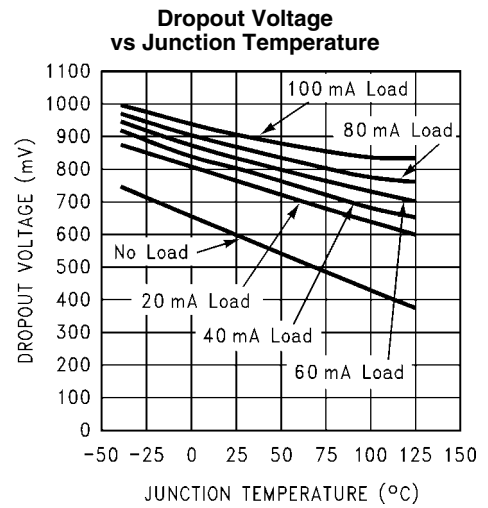

10007120

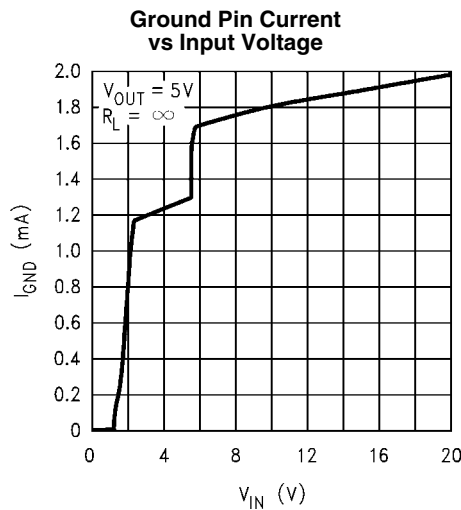

10007109

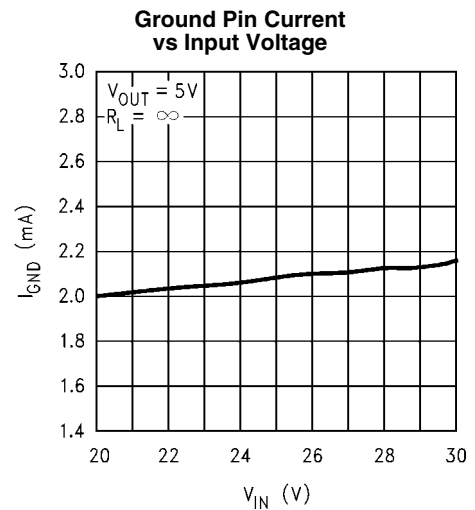

10007110

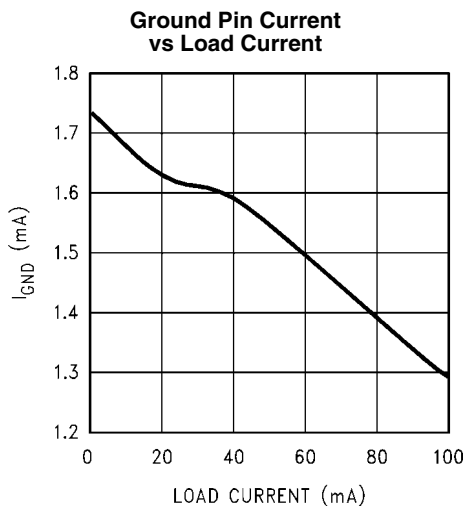

10007121

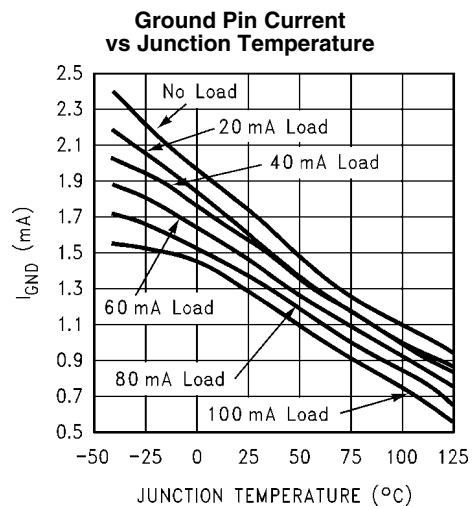

10007122

**Input Current vs Input Voltage**

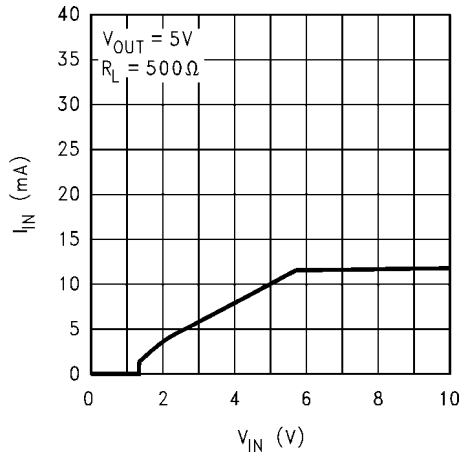

10007111

**Input Current vs Input Voltage**

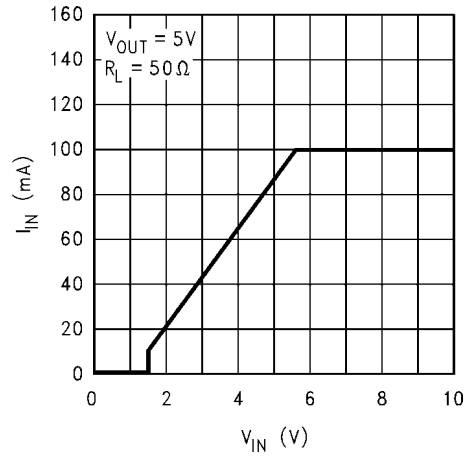

10007112

**Line Transient Response**

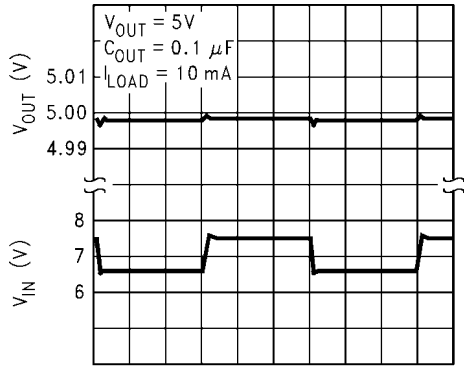

200  $\mu s$ /Div

10007103

**Line Transient Response**

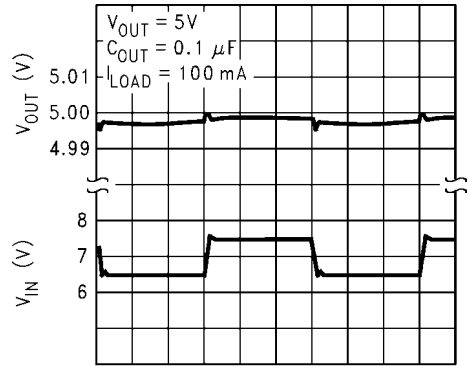

200  $\mu s$ /Div

10007104

**Load Transient Response**

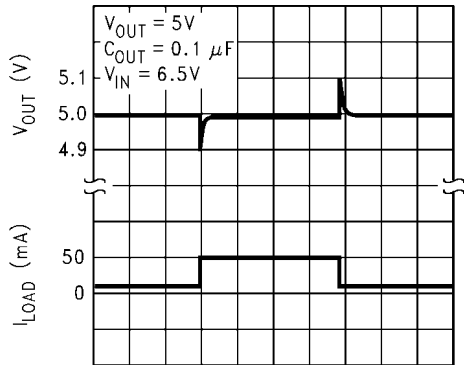

50  $\mu s$ /Div

10007105

**Load Transient Response**

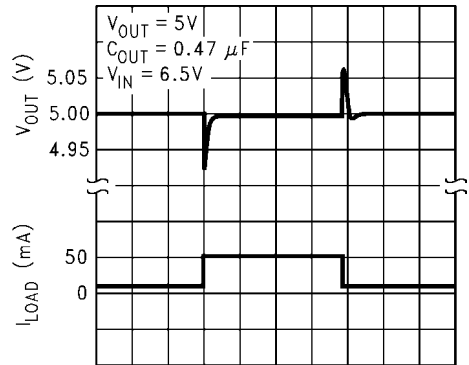

50  $\mu s$ /Div

10007106

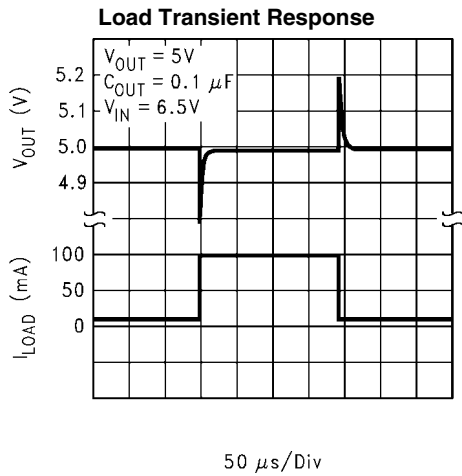

10007107

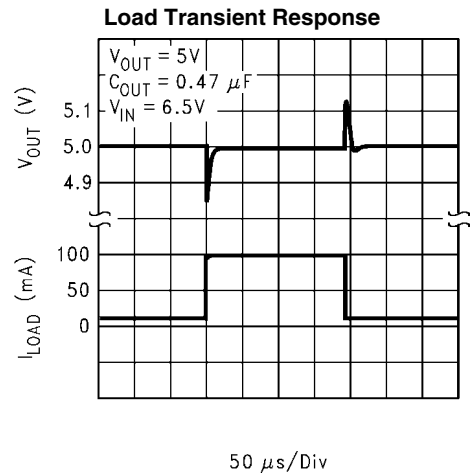

10007108

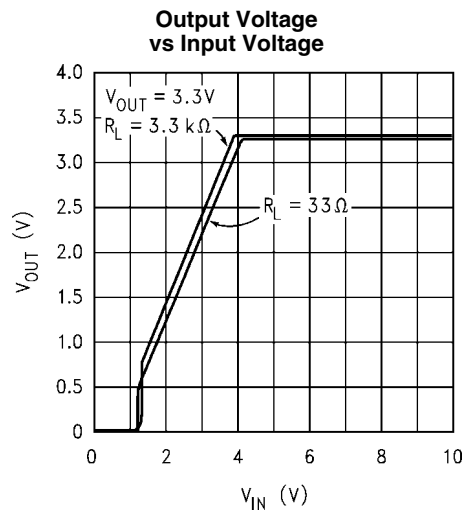

10007113

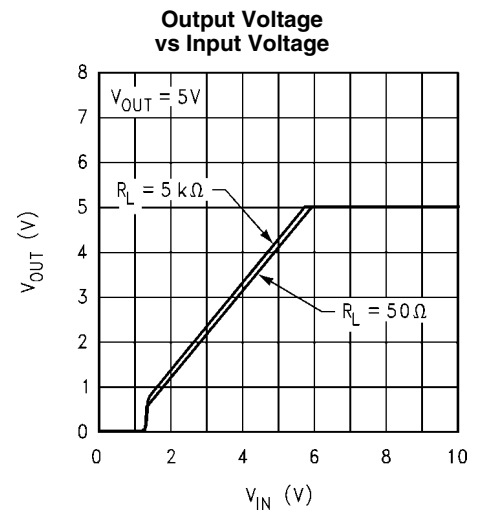

10007114

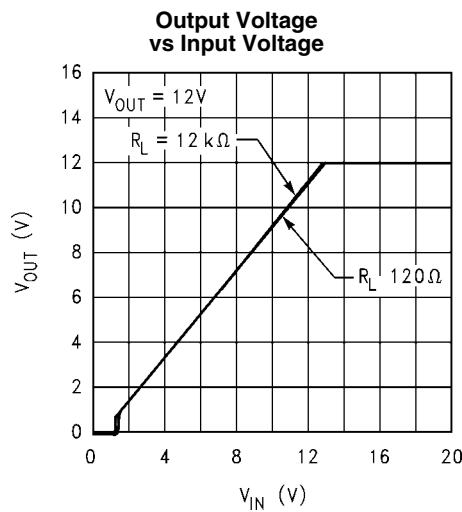

10007115

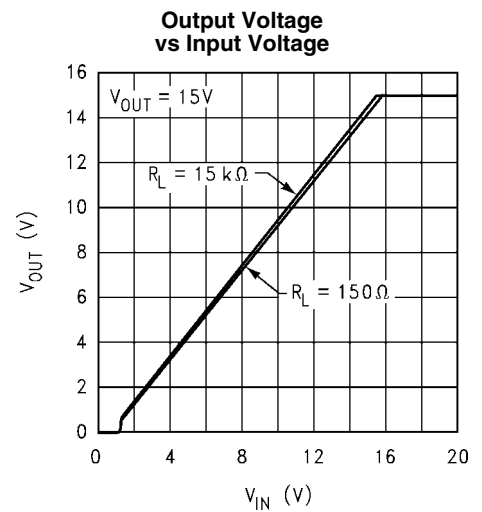

10007116



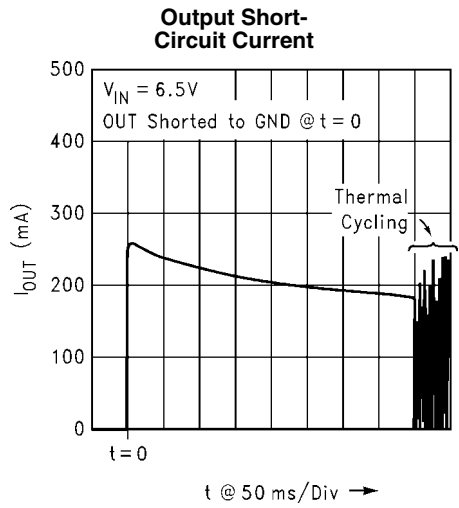

10007117

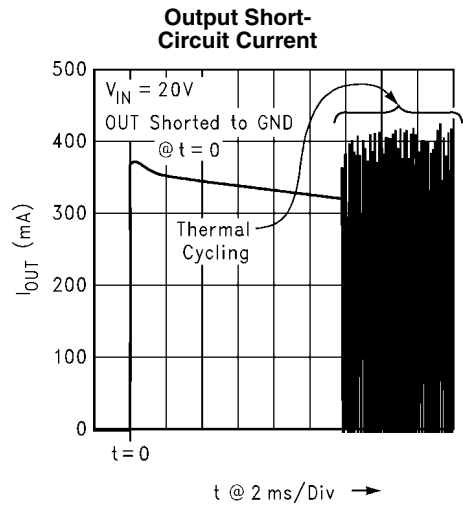

10007118

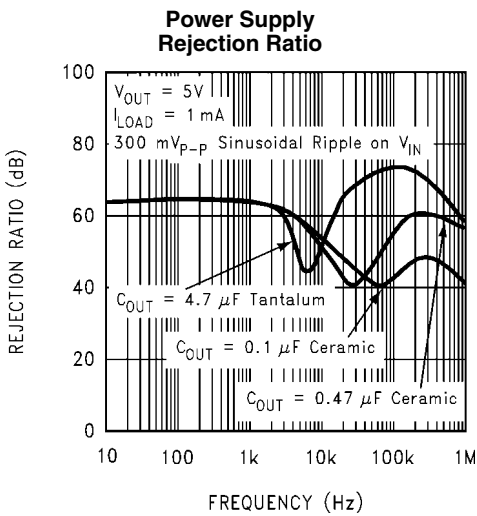

10007124

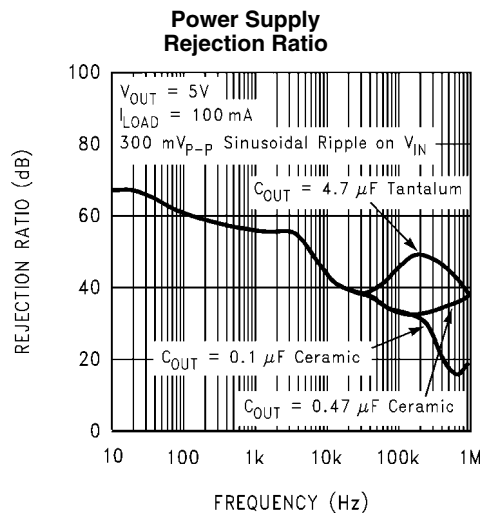

10007125

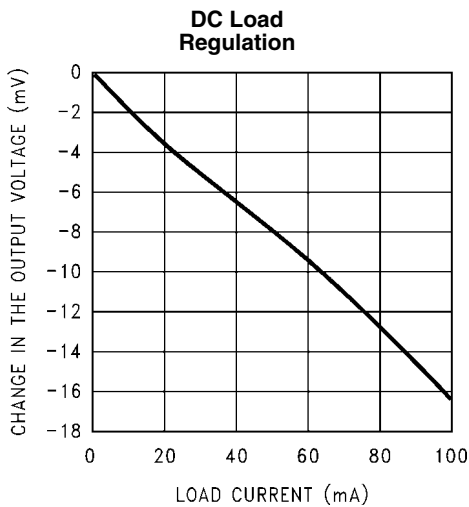

10007123

## Applications Information

### ON/OFF Pin

The LM3490 features a logic controlled ON/OFF pin that will allow the output voltage to be disabled, or enabled, as needed. The defined operating voltage range for this pin is 0.0V to 5.0V. The ON/OFF pin can not be left floating, as the output status cannot be guaranteed. Additionally, the ON/OFF pin should not be biased below ground potential as unpredictable device behavior may occur.

Pulling the ON/OFF pin voltage to a value between the  $V_{IH}$  threshold and 5.0V will enable the output voltage. Pulling the

ON/OFF pin voltage to a value between the  $V_{IL}$  threshold and Ground potential will disable the output voltage. Although the ON/OFF threshold is typically 725mV, and has no hysteresis, the ON/OFF signal must rise and fall, cleanly and promptly, from voltage levels that are below the  $V_{IL}$  threshold and above the  $V_{IH}$  threshold.

The ON/OFF pin has no internal pull-up or pull-down to establish a default condition and, as a result, this pin must be terminated, either actively or passively, to an appropriate voltage level.

**Physical Dimensions** inches (millimeters) unless otherwise noted

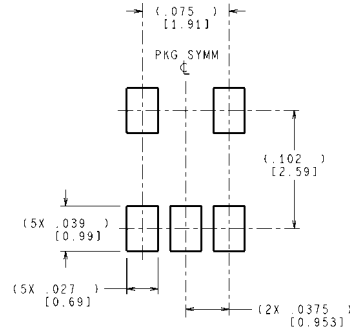
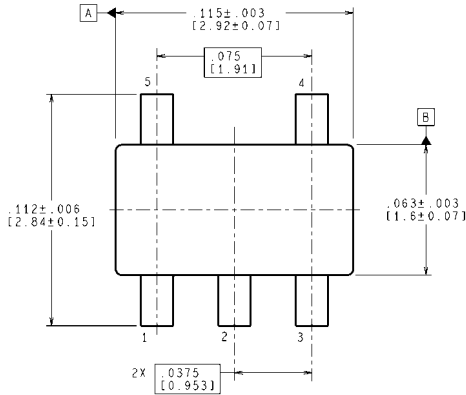

LAND PATTERN RECOMMENDATION

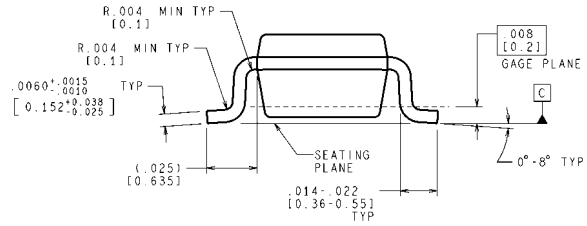
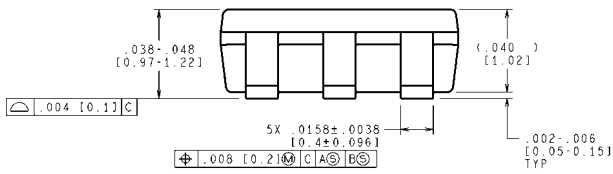

CONTROLLING DIMENSION IS INCH  
VALUES IN [ ] ARE MILLIMETERS  
DIMENSIONS IN ( ) FOR REFERENCE ONLY

MF05A (Rev C)

**SOT-23 Package**  
**5-Lead Small-Outline Package (M5)**  
**For Ordering, Refer to Ordering Information Table**  
**NS Package Number MF05A**

## Notes

THE CONTENTS OF THIS DOCUMENT ARE PROVIDED IN CONNECTION WITH NATIONAL SEMICONDUCTOR CORPORATION ("NATIONAL") PRODUCTS. NATIONAL MAKES NO REPRESENTATIONS OR WARRANTIES WITH RESPECT TO THE ACCURACY OR COMPLETENESS OF THE CONTENTS OF THIS PUBLICATION AND RESERVES THE RIGHT TO MAKE CHANGES TO SPECIFICATIONS AND PRODUCT DESCRIPTIONS AT ANY TIME WITHOUT NOTICE. NO LICENSE, WHETHER EXPRESS, IMPLIED, ARISING BY ESTOPPEL OR OTHERWISE, TO ANY INTELLECTUAL PROPERTY RIGHTS IS GRANTED BY THIS DOCUMENT.

TESTING AND OTHER QUALITY CONTROLS ARE USED TO THE EXTENT NATIONAL DEEMS NECESSARY TO SUPPORT NATIONAL'S PRODUCT WARRANTY. EXCEPT WHERE MANDATED BY GOVERNMENT REQUIREMENTS, TESTING OF ALL PARAMETERS OF EACH PRODUCT IS NOT NECESSARILY PERFORMED. NATIONAL ASSUMES NO LIABILITY FOR APPLICATIONS ASSISTANCE OR BUYER PRODUCT DESIGN. BUYERS ARE RESPONSIBLE FOR THEIR PRODUCTS AND APPLICATIONS USING NATIONAL COMPONENTS. PRIOR TO USING OR DISTRIBUTING ANY PRODUCTS THAT INCLUDE NATIONAL COMPONENTS, BUYERS SHOULD PROVIDE ADEQUATE DESIGN, TESTING AND OPERATING SAFEGUARDS.

EXCEPT AS PROVIDED IN NATIONAL'S TERMS AND CONDITIONS OF SALE FOR SUCH PRODUCTS, NATIONAL ASSUMES NO LIABILITY WHATSOEVER, AND NATIONAL DISCLAIMS ANY EXPRESS OR IMPLIED WARRANTY RELATING TO THE SALE AND/OR USE OF NATIONAL PRODUCTS INCLUDING LIABILITY OR WARRANTIES RELATING TO FITNESS FOR A PARTICULAR PURPOSE, MERCHANTABILITY, OR INFRINGEMENT OF ANY PATENT, COPYRIGHT OR OTHER INTELLECTUAL PROPERTY RIGHT.

### LIFE SUPPORT POLICY

**NATIONAL'S PRODUCTS ARE NOT AUTHORIZED FOR USE AS CRITICAL COMPONENTS IN LIFE SUPPORT DEVICES OR SYSTEMS WITHOUT THE EXPRESS PRIOR WRITTEN APPROVAL OF THE CHIEF EXECUTIVE OFFICER AND GENERAL COUNSEL OF NATIONAL SEMICONDUCTOR CORPORATION.** As used herein:

Life support devices or systems are devices which (a) are intended for surgical implant into the body, or (b) support or sustain life and whose failure to perform when properly used in accordance with instructions for use provided in the labeling can be reasonably expected to result in a significant injury to the user. A critical component is any component in a life support device or system whose failure to perform can be reasonably expected to cause the failure of the life support device or system or to affect its safety or effectiveness.

National Semiconductor and the National Semiconductor logo are registered trademarks of National Semiconductor Corporation. All other brand or product names may be trademarks or registered trademarks of their respective holders.

Copyright© 2007 National Semiconductor Corporation

For the most current product information visit us at [www.national.com](http://www.national.com)



**National Semiconductor Americas Customer Support Center**  
Email: [new.feedback@nsc.com](mailto:new.feedback@nsc.com)  
Tel: 1-800-272-9959

**National Semiconductor Europe Customer Support Center**  
Fax: +49 (0) 180-530-85-86  
Email: [europe.support@nsc.com](mailto:europe.support@nsc.com)  
Deutsch Tel: +49 (0) 69 9508 6208  
English Tel: +49 (0) 870 24 0 2171  
Français Tel: +33 (0) 1 41 91 8790

**National Semiconductor Asia Pacific Customer Support Center**  
Email: [ap.support@nsc.com](mailto:ap.support@nsc.com)

**National Semiconductor Japan Customer Support Center**  
Fax: 81-3-5639-7507  
Email: [jpn.feedback@nsc.com](mailto:jpn.feedback@nsc.com)  
Tel: 81-3-5639-7560