

General Description

The MIC37501 and MIC37502 are 5A, low dropout linear voltage regulator that provide low voltage, high current outputs with a minimum of external components. They offer high precision, ultra-low dropout (500mV), and low ground current.

The MIC37501 and MIC37502 operate from an input of 2.3V to 6.0V. They are designed to drive digital circuits requiring low voltage at high currents (i.e., PLDs, DSPs, microcontrollers, etc.). They are available in fixed and adjustable output voltages. Fixed voltages include 1.5V, 1.65V, 1.8V, 2.5V, and 3.3V. The adjustable version is capable of 1.24V to 5.5V.

MIC37501 and MIC37502 LDOs feature thermal and current limit protection and reverse current protection. Logic enable and error flag pins are available.

Junction temperature range of the MIC37501/02 is from -40°C to 125°C .

For applications requiring input voltage greater than 6.0V, see MIC3910x, MIC3915x, MIC3930x, and MIC3950x LDOs.

All support documentation can be found on Micrel's web site at www.micrel.com.

Features

- 5A minimum guaranteed output current
- 500mV maximum dropout voltage
 - Ideal for 3.0V to 2.5V conversion
 - Ideal for 2.5V to 1.8V, 1.65V, or 1.5V conversion
- Stable with ceramic or tantalum capacitor
- Wide input voltage range:
 - V_{IN} : 2.3V to 6.0V
- $\pm 1.0\%$ initial output tolerance
- Fixed and adjustable output voltages:
 - MIC37501—7 terminal fixed voltage
 - MIC37502—5 (TO-263) and 7 (SPAK) terminal adjustable voltage
- Excellent line and load regulation specifications
- Logic controlled shutdown
- Thermal shutdown and current-limit protection
- Reverse-leakage protection
- Low profile S-Pak and TO-263 packages

Applications

- LDO linear regulator for low-voltage digital IC
- PC add-in cards
- High efficiency linear power supplies
- SMPS post regulator
- Battery charger

Typical Applications

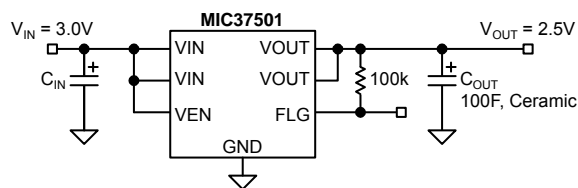

Fixed 2.5V Regulator with Error Flag

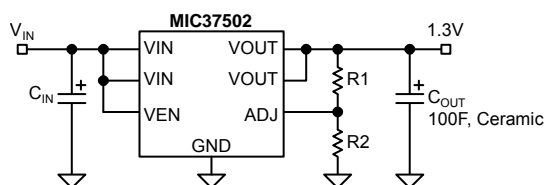

Adjustable Regulator

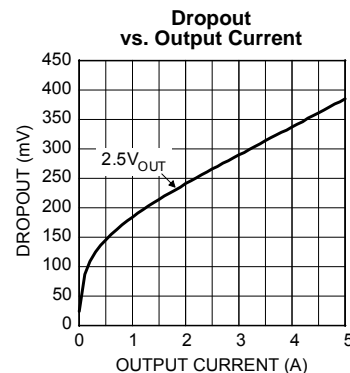

Super β is a registered trademark of Micrel Inc.

Micrel Inc. • 2180 Fortune Drive • San Jose, CA 95131 • USA • tel +1 (408) 944-0800 • fax +1 (408) 474-1000 • <http://www.micrel.com>

Ordering Information

| Part Number | | Output Current | Voltage ⁽²⁾ | Junction Temp. Range | Package |
|-----------------|-------------------------------|----------------|------------------------|----------------------|----------|
| Standard | RoHS Compliant ⁽¹⁾ | | | | |
| MIC37501-1.5BR | MIC37501-1.5WR | 5A | 1.5V | -40°C to +125°C | S-Pak-7 |
| MIC37501-1.65BR | MIC37501-1.65WR | 5A | 1.65V | -40°C to +125°C | S-Pak-7 |
| MIC37501-1.8BR | MIC37501-1.8WR | 5A | 1.8V | -40°C to +125°C | S-Pak-7 |
| MIC37501-2.5BR | MIC37501-2.5WR | 5A | 2.5V | -40°C to +125°C | S-Pak-7 |
| MIC37501-3.3BR | MIC37501-3.3WR | 5A | 3.3V | -40°C to +125°C | S-Pak-7 |
| MIC37502BR | MIC37502WR | 5A | Adj. | -40°C to +125°C | S-Pak-7 |
| MIC37502BU | MIC37502WU | 5A | Adj. | -40°C to +125°C | To-263-5 |

Note:

1. RoHS compliant with "high-melting solder" exemption.
2. Other Voltage available. Contact Micrel for detail.

Pin Configuration

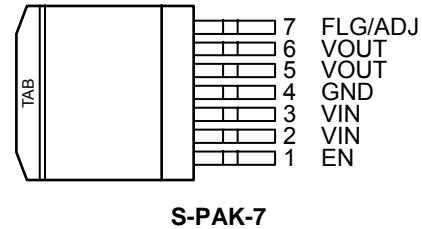
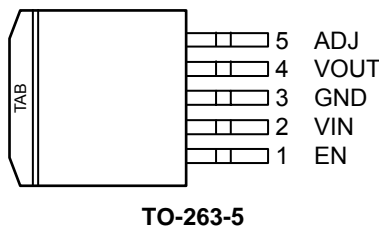

Pin Description

| Pin Number TO-263-5 | Pin Number S-PAK-7 | Pin Name | Pin Name |
|---------------------|--------------------|----------|--|
| 1 | 1 | EN | Enable (input): CMOS-compatible input. Logic high = enable, logic low = shutdown. |
| 2 | 2, 3 | VIN | Input voltage which supplies current to the output power device. Connect pins 2 and 3 together externally. |
| 3 | 4 | GND | Ground (TAB is connected to ground on S-Pak). |
| 4 | 5, 6 | VOUT | Regulator Output: Connect pins 5 and 6 together externally. |
| — | 7 | FLG | Error Flag (output): Open collector output. Active low indicates an output fault condition. |
| 5 | 7 | ADJ | Adjustable regulator feedback input. Connect to resistor voltage divider. |

Absolute Maximum Ratings⁽¹⁾

| | |
|--------------------------------------|--|
| Supply Voltage (V_{IN}) | 6.5V |
| Enable Input Voltage (V_{EN}) | 6.5V |
| Power Dissipation (P_D) | Internally Limited |
| Junction Temperature (T_J) | $-40^{\circ}\text{C} \leq T_J \leq +125^{\circ}\text{C}$ |
| Storage Temperature (T_S) | $-65^{\circ}\text{C} \leq T_J \leq +150^{\circ}\text{C}$ |
| Lead Temperature (soldering, 5 sec.) | 260°C |
| ESD Rating ⁽³⁾ | 2kV |

Operating Ratings⁽²⁾

| | |
|--------------------------------------|--|
| Supply Voltage (V_{IN}) | 2.3V to 6.0V |
| Enable Input Voltage (V_{EN}) | 0V to 6.0V |
| Junction Temperature Range (T_J) | $-40^{\circ}\text{C} \leq T_J \leq +125^{\circ}\text{C}$ |
| Maximum Power Dissipation | Note 4 |
| Package Thermal Resistance | |
| S-Pak (θ_{JC}) | 2°C/W |
| TO-263 (θ_{JC}) | 2°C/W |

Electrical Characteristics⁽⁵⁾

$T_A = 25^{\circ}\text{C}$ with $V_{IN} = V_{OUT} + 1\text{V}$; $V_{EN} = V_{IN}$; **bold** values indicate $-40^{\circ}\text{C} < T_J < +125^{\circ}\text{C}$; unless otherwise noted.

| Parameter | Condition | Min | Typ | Max | Units |
|---|---|----------------|-------|----------------|--------------------------------|
| Output Voltage Accuracy | $I_L = 10\text{mA}$ | -1 | | +1 | % |
| | $10\text{mA} < I_{OUT} < I_{L(max)}$, $V_{OUT} + 1 \leq V_{IN} \leq 6\text{V}$ | -2 | | +2 | % |
| Output Voltage Line Regulation | $V_{IN} = V_{OUT} + 1.0\text{V}$ to 6.0V | | 0.06 | 0.5 | % |
| Output Voltage Load Regulation | $I_L = 10\text{mA}$ to 5A | | 0.2 | 1 | % |
| $V_{IN} - V_{OUT}$, Dropout Voltage ⁽⁶⁾ | $I_L = 2.5\text{A}$ | | | 350 | mV |
| | $I_L = 5\text{A}$ | | 330 | 500 | mV |
| Ground Pin Current ⁽⁷⁾ | $I_L = 5\text{A}$ | | 57 | 100 | mA |
| Ground Pin Current in Shutdown | $V_{IL} < 0.5\text{V}$, $V_{IN} = V_{OUT} + 1\text{V}$ | | 1.0 | | μA |
| Current Limit | $V_{OUT} = 0$ | 5 | 7.5 | 11 | A |
| Start-up Time | $V_{EN} = V_{IN}$, $I_{OUT} = 10\text{mA}$, $C_{OUT} = 100\mu\text{F}$ | | 170 | 500 | μs |
| Enable Input | | | | | |
| Enable Input Threshold | Regulator enable | 2.25 | | | V |
| | Regulator shutdown | | | 0.8 | V |
| Enable Pin Input Current | $V_{IL} < 0.8\text{V}$ (Regulator shutdown) | | | 2 4 | μA μA |
| | $V_{IH} > 2.25\text{V}$ (Regulator enabled) | 1 | 15 | 30 75 | μA μA |
| Flag Output | | | | | |
| $I_{FLG(LEAK)}$ | $V_{OH} = 6\text{V}$ | | | 1 2 | μA μA |
| | | | | | |
| $V_{FLG(LO)}$ | $V_{IN} = 2.25\text{V}$, $I_{OL} = 250\mu\text{A}$ ⁽⁸⁾ | | 210 | 400 500 | mV mV |
| V_{FLG} | Low threshold, % of V_{OUT} below nominal | 93 | | | % |
| | Hysteresis | | 2 | | % |
| | High threshold, % of V_{OUT} below nominal | | | 99.2 | % |
| MIC37502 Only | | | | | |
| Reference Voltage | | 1.228 1.215 | 1.240 | 1.252 1.265 | V V |
| | | | | | |
| Adjust Pin Bias Current | | | 40 | 80 120 | nA nA |

Notes:

1. Exceeding the ratings in the "Absolute Maximum Ratings" section may damage the device.
2. The device is not guaranteed to function outside its operating rating.
3. Devices are ESD sensitive. Handling precautions recommended. Human body model, 1.5k Ω in series with 100pF.
4. $P_{D(max)} = (T_{J(max)} - T_A) / \theta_{JC}$, where θ_{JC} depends upon the printed circuit layout. See "Applications Information" section.
5. Specification for packaged product only
6. $V_{DO} = V_{IN} - V_{OUT}$ when V_{OUT} decreased to 98% of its nominal output voltage with $V_{IN} = V_{OUT} + 1V$. For output voltages below 1.75V, dropout voltage specification does not apply but to a minimum input operating voltage of 2.3V.
7. I_{GND} is the quiescent current. $I_{IN} = I_{GND} + I_{OUT}$.
8. For a 2.5V device, $V_{IN} = 2.3V$ (device is in dropout).

Typical Characteristics

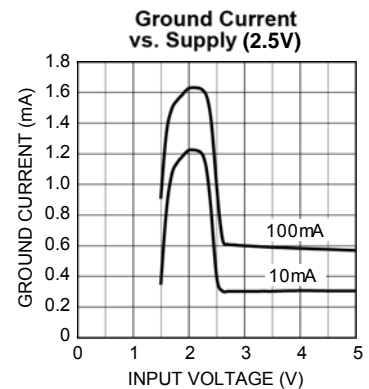
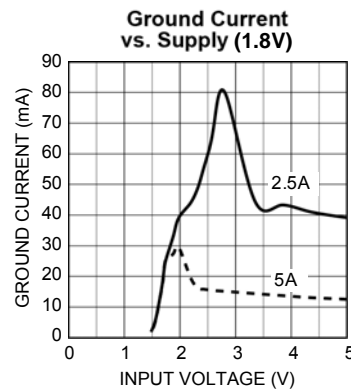
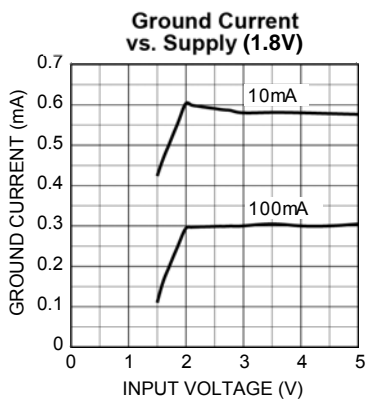
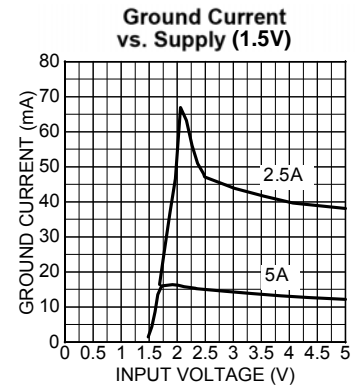
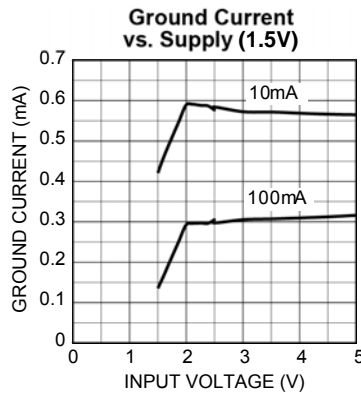
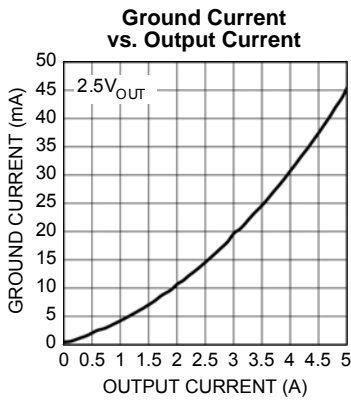
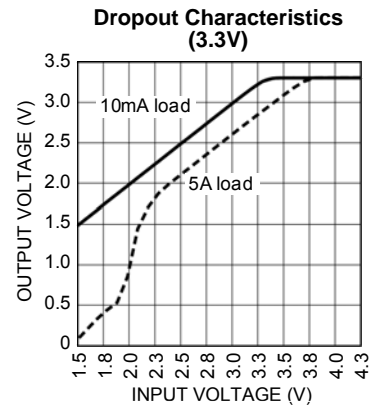
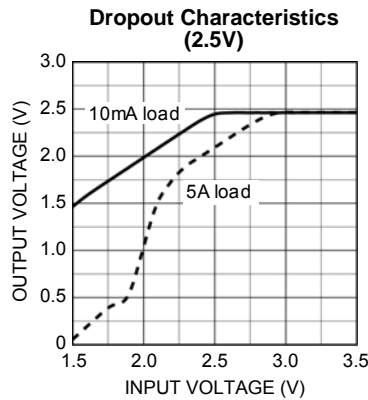
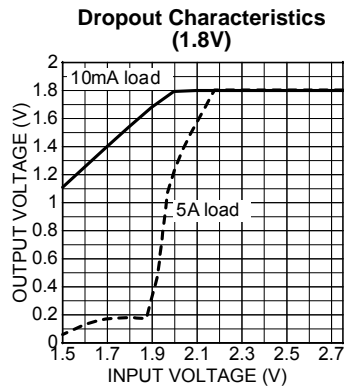
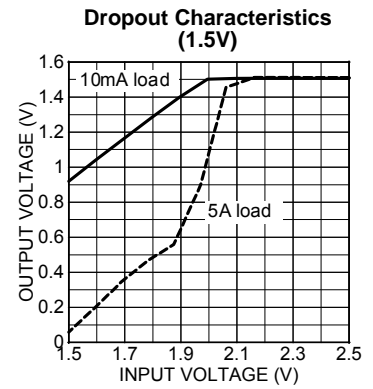
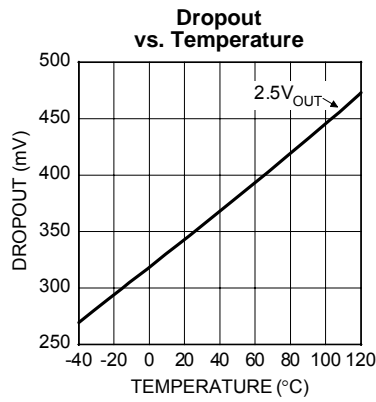
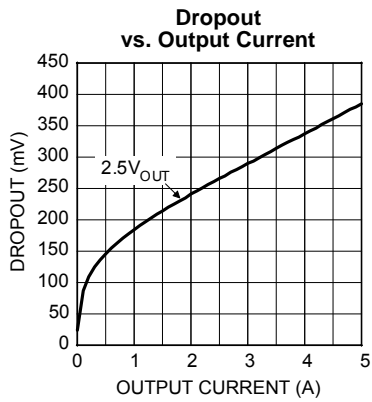

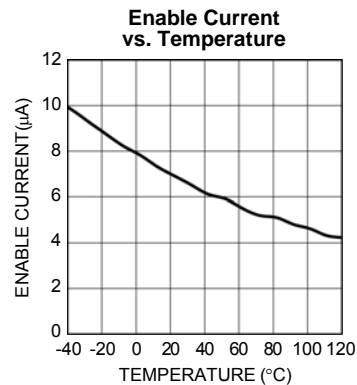
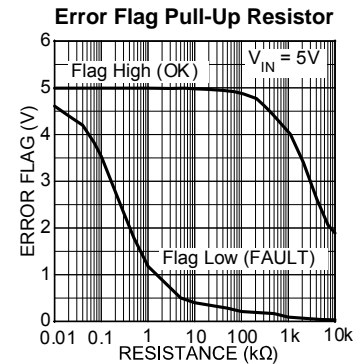
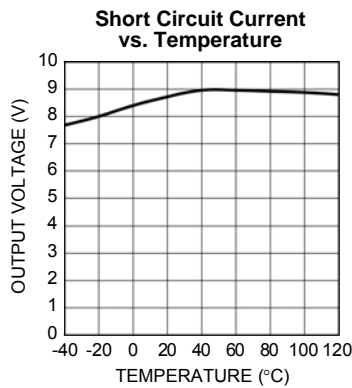
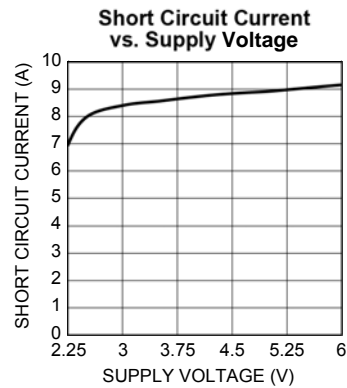
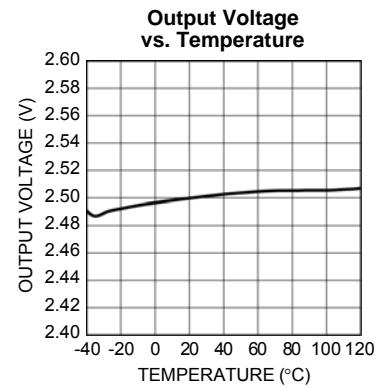
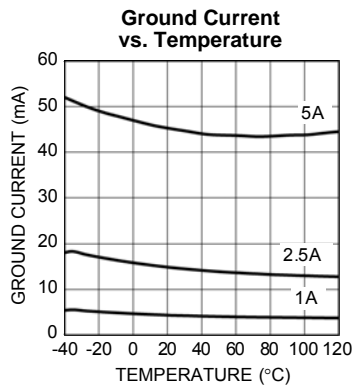
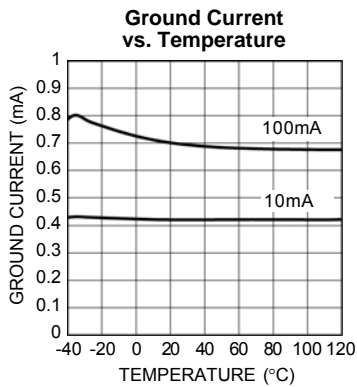
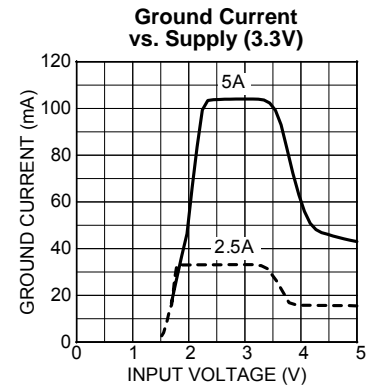
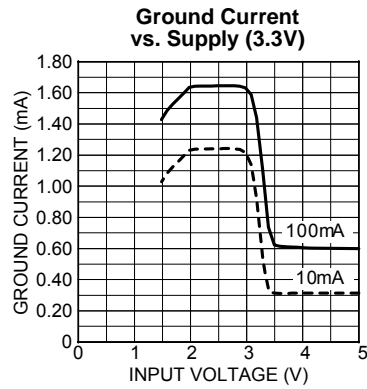
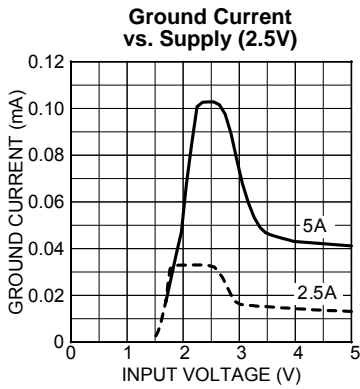

Functional Characteristics

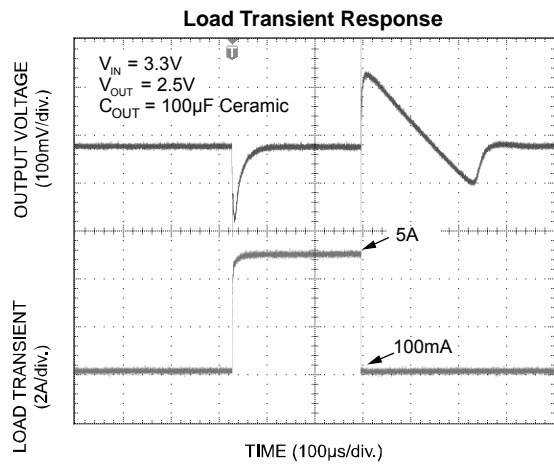
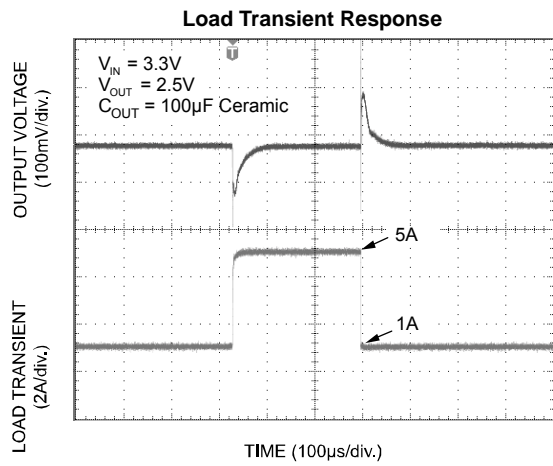
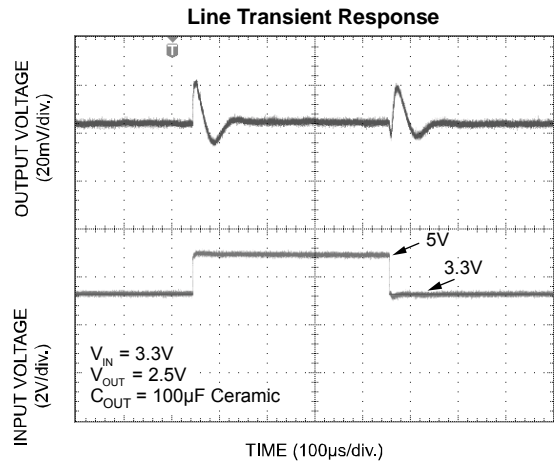
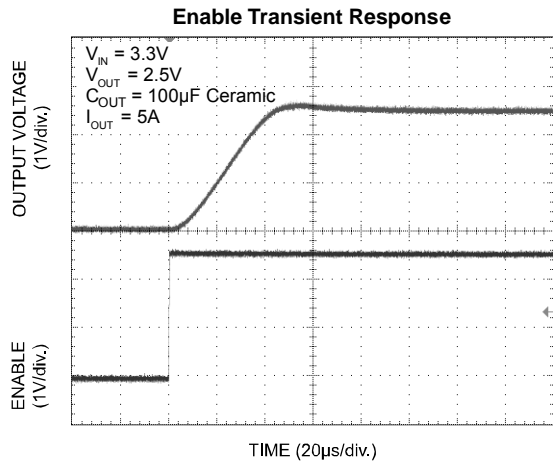

Application Information

The MIC37501/02 is a high-performance, low dropout voltage regulator suitable for moderate to high-current regulator applications. Its 500mV dropout voltage at full load makes it especially valuable in battery-powered systems and as a high-efficiency noise filter in post-regulator applications. Unlike older NPN-pass transistor designs, where the minimum dropout voltage is limited by the base-to-emitter voltage drop and collector-to-emitter saturation voltage, dropout performance of the PNP output of these devices is limited only by the low V_{CE} saturation voltage.

A trade-off for the low dropout voltage is a varying base drive requirement. Micrel's Super β PNP[®] process reduces this drive requirement to only 2% to 5% of the load current.

The MIC37501/02 regulator is fully protected from damage due to fault conditions. Current limiting is provided. This limiting is linear; output current during overload conditions is constant. Thermal shutdown disables the device when the die temperature exceeds the maximum safe operating temperature. The output structure of these regulators allows voltages in excess of the desired output voltage to be applied without reverse current flow.

Thermal Design

Linear regulators are simple to use. The most complicated design parameters to consider are thermal characteristics. Thermal design requires the following application-specific parameters:

- Maximum ambient temperature (T_A)
- Output current (I_{OUT})
- Output voltage (V_{OUT})
- Input voltage (V_{IN})
- Ground current (I_{GND})

First, calculate the power dissipation of the regulator from these numbers and the device parameters from this data sheet.

$$P_D = (V_{IN} - V_{OUT}) I_{OUT} + V_{IN} I_{GND}$$

where the ground current is approximated by using numbers from the "Electrical Characteristics" or "Typical Characteristics" sections. The heat sink thermal resistance is then determined with this formula:

$$\theta_{SA} = ((T_J(\max) - T_A) / P_D) - (\theta_{JC} + \theta_{CS})$$

Where $T_J(\max) \leq 125^\circ\text{C}$ and θ_{CS} is between 0°C and 2°C/W . The heat sink may be significantly reduced in applications where the minimum input voltage is known and is large compared with the dropout voltage. Use a series input resistor to drop excessive voltage and distribute the heat between this resistor

and the regulator. The low dropout properties of Micrel Super β PNP[®] regulators allow significant reductions in regulator power dissipation and the associated heat sink without compromising performance. When this technique is employed, a capacitor of at least $1.0\mu\text{F}$ is needed directly between the input and regulator ground.

Refer to "Application Note 9" for further details and examples on thermal design and heat sink applications.

Output Capacitor

The MIC37501/02 requires an output capacitor for stable operation. As a μCap LDO, the MIC37501/02 can operate with ceramic output capacitors as long as the amount of capacitance is $100\mu\text{F}$ or greater. For values of output capacitance lower than $100\mu\text{F}$, the recommended ESR range is $200\text{m}\Omega$ to 2Ω . The minimum value of output capacitance recommended for the MIC37501/02 is $47\mu\text{F}$.

For $100\mu\text{F}$ or greater, the ESR range recommended is less than 1Ω . Ultra-low ESR ceramic capacitors are recommended for output capacitance of $100\mu\text{F}$ or greater to help improve transient response and noise reduction at high frequency. X7R/X5R dielectric-type ceramic capacitors are recommended because of their temperature performance. X7R type capacitors change capacitance by 15% over their operating temperature range and are the most stable type of ceramic capacitors. Z5U and Y5V dielectric capacitors change value by as much as 50% and 60%, respectively, over their operating temperature ranges. To use a ceramic chip capacitor with Y5V dielectric, the value must be much higher than an X7R ceramic capacitor to ensure the same minimum capacitance over the equivalent operating temperature range.

Input Capacitor

An input capacitor of $1.0\mu\text{F}$ or greater is recommended when the device is more than 4 inches away from the bulk supply capacitance, or when the supply is a battery. Small, surface mount chip capacitors can be used for the bypassing. The capacitor should be placed within 1" of the device for optimal performance. Larger values will help to improve ripple rejection by bypassing the input to the regulator, further improving the integrity of the output voltage.

Transient Response and 3.3V to 2.5V, 2.5V to 1.8V or 1.65V, or 2.5V to 1.5V Conversions

The MIC37501/02 has excellent transient response to variations in input voltage and load current. The device has been designed to respond quickly to load current variations and input voltage variations. Large output capacitors are not required to obtain this performance. A standard $47\mu\text{F}$ output capacitor is all

that is required. Larger values help to improve performance even further.

By virtue of its low dropout voltage, this device does not saturate into dropout as readily as similar NPN-based designs. When converting from 3.3V to 2.5V, 2.5V to 1.8V or 1.65V, or 2.5V to 1.5V, the NPN-based regulators are already operating in dropout, with typical dropout requirements of 1.2V or greater. To convert down to 2.5V without operating in dropout, NPN-based regulators require an input voltage of at least 3.7V. The MIC37501/02 regulator will provide excellent performance with an input as low as 3.0V or 2.25V, respectively. This gives the PNP-based regulators a distinct advantage over older, NPN-based linear regulators.

Minimum Load Current

The MIC37501/02 regulator is specified between finite loads. If the output current is too small, leakage currents dominate and the output voltage rises. A 10mA minimum load current is necessary for proper operation.

Error Flag

The MIC37501 features an error flag circuit that monitors the output voltage and signals an error condition when the voltage drops 5% below the nominal output voltage. The error flag is an open-collector output that can sink 10mA during a fault condition.

Low output voltage can be caused by a number of problems, including an overcurrent fault (device in current limit) or low input voltage. The flag is inoperative during overtemperature shutdown.

Enable Input

The MIC37501/02 also features an enable input for on/off control of the device. Its shutdown state draws “zero” current (only microamperes of leakage). The enable input is TTL/CMOS-compatible for simple logic interface, but can be connected up to V_{IN} . When enabled, it draws approximately 15 μ A.

Adjustable Regulator Design

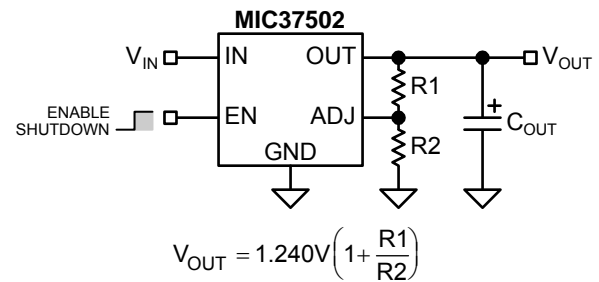

Figure 2. Adjustable Regulator with Resistors

The MIC37502 allows programming the output voltage anywhere between 1.24V and the 5.5V maximum operating rating of the family. Two resistors are used. Resistors can be quite large, up to 1M Ω , because of the very high input impedance and low bias current of the sense comparator.

The resistor values are calculated by:

$$R1 = R2 \left(\frac{V_{OUT}}{1.240} - 1 \right)$$

Where V_{OUT} is the desired output voltage. Figure 2 shows component definition. Applications with widely varying load currents may scale the resistors to draw the minimum load current required for proper operation (see above).

Package Information

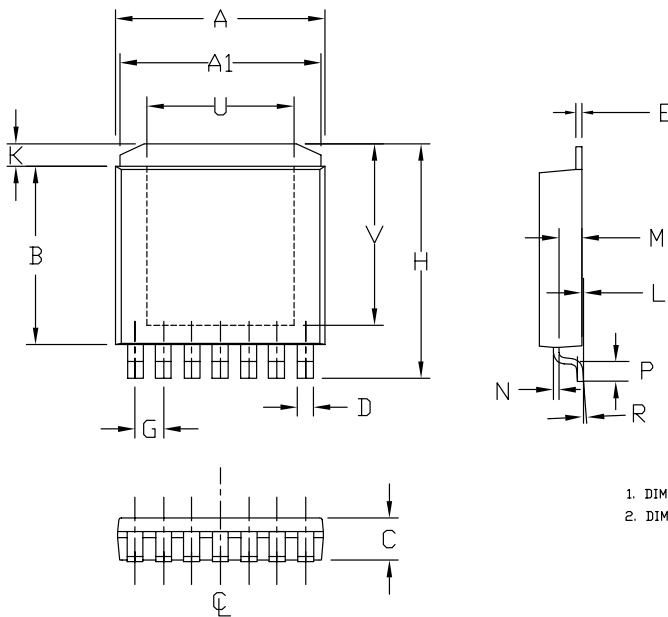

| | INCHES | | MILLIMETERS | |
|----|--------|-------|-------------|-------|
| | | | | |
| A | 0.365 | 0.375 | 9.27 | 9.52 |
| A1 | 0.350 | 0.360 | 8.89 | 9.14 |
| B | 0.310 | 0.320 | 7.87 | 8.13 |
| C | 0.070 | 0.080 | 1.78 | 2.03 |
| D | 0.025 | 0.031 | 0.63 | 0.79 |
| E | 0.010 | BSC | 0.25 | BSC |
| G | 0.050 | BSC | 1.27 | BSC |
| H | 0.410 | 0.420 | 10.41 | 10.67 |
| K | 0.030 | 0.050 | 0.76 | 1.27 |
| L | 0.001 | 0.005 | 0.03 | 0.13 |
| M | 0.035 | 0.045 | 0.89 | 1.14 |
| N | 0.010 | BSC | 0.25 | BSC |
| P | 0.031 | 0.041 | 0.79 | 1.04 |
| R | 0° | 6° | 0° | 6° |
| U | 0.256 | BSC | 6.50 | BSC |
| V | 0.316 | BSC | 8.03 | BSC |

1. DIMENSION DOES NOT INCLUDE MOLD FLASH OR PROTRUSIONS.
2. DIMENSION INCLUDES PLATING THICKNESS

7-Pin S-PAK (R)

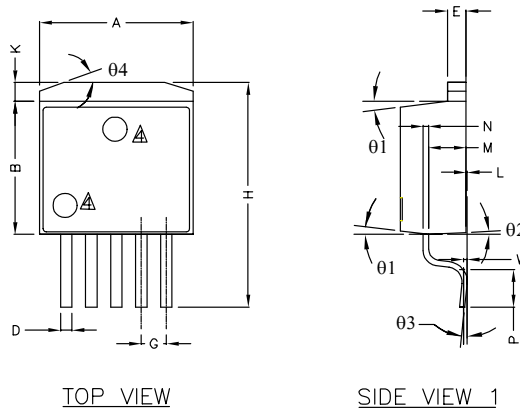

| PDS | INCH | | MM | |
|--------|-------|-------|--------|--------|
| | MIN | MAX | MIN | MAX |
| A | 0.396 | 0.420 | 10.058 | 10.668 |
| B | 0.330 | 0.361 | 8.382 | 9.169 |
| C | 0.170 | 0.181 | 4.318 | 4.597 |
| D | 0.026 | 0.036 | 0.660 | 0.914 |
| E | 0.045 | 0.055 | 1.143 | 1.397 |
| G | 0.67 | Ref. | 1.70 | Ref. |
| H | 0.575 | 0.625 | 14.605 | 15.875 |
| K | 0.045 | 0.066 | 1.143 | 1.676 |
| L | 0 | 0.012 | 0 | 0.305 |
| M | 0.080 | 0.120 | 2.032 | 3.048 |
| N | 0.012 | 0.023 | 0.305 | 0.584 |
| P | 0.090 | .0110 | 2.286 | 2.794 |
| theta1 | 3° | 10° | 3° | 10° |
| theta2 | 1° | 7° | 1° | 7° |
| theta3 | 0° | 8° | 0° | 8° |
| theta4 | 18° | 22° | 18° | 22° |
| U | 0.300 | Ref. | 7.620 | Ref. |
| V | 0.305 | Ref. | 7.747 | Ref. |
| W | 0.010 | Ref. | 0.254 | Ref. |

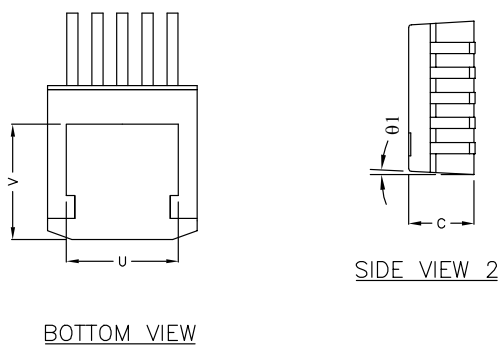

- NOTE:
1. PACKAGE OUTLINE EXCLUSIVE OF MOLD FLASH & METAL BURR.
 2. PACKAGE OUTLINE INCLUSIVE OF PLATING THICKNESS.
 3. FOOT LENGTH MEASURED AT INTERCEPT POINT BETWEEN DATUM A & LEAD SURFACE
- ▲ PACKAGE TOP MARK MAY BE IN TOP CENTER OR LOWER LEFT CORNER

5-Pin TO-263 (U)

MICREL, INC. 2180 FORTUNE DRIVE SAN JOSE, CA 95131 USA
TEL +1 (408) 944-0800 FAX +1 (408) 474-1000 WEB <http://www.micrel.com>

The information furnished by Micrel in this data sheet is believed to be accurate and reliable. However, no responsibility is assumed by Micrel for its use. Micrel reserves the right to change circuitry and specifications at any time without notification to the customer.

Micrel Products are not designed or authorized for use as components in life support appliances, devices or systems where malfunction of a product can reasonably be expected to result in personal injury. Life support devices or systems are devices or systems that (a) are intended for surgical implant into the body or (b) support or sustain life, and whose failure to perform can be reasonably expected to result in a significant injury to the user. A Purchaser's use or sale of Micrel Products for use in life support appliances, devices or systems is a Purchaser's own risk and Purchaser agrees to fully indemnify Micrel for any damages resulting from such use or sale.

© 2004 Micrel, Incorporated.