

DESCRIPTION

The SG117A Series are 3-terminal positive adjustable voltage regulators which offer improved performance over the original 117 design. A major feature of the SG117A is reference voltage tolerance guaranteed within $\pm 1\%$, allowing an overall power supply tolerance to be better than 3% using inexpensive 1% resistors. Line and load regulation performance has been improved as well.

Additionally, the SG117A reference voltage is guaranteed not to exceed 2% when operating over the full load, line and power dissipation conditions. The SG117A adjustable regulators offer an improved solution for all positive voltage regulator requirements with load currents up to 1.5A.

IMPORTANT: For the most current data, consult MICROSEMI's website: <http://www.microsemi.com>

KEY FEATURES

- 1% output voltage tolerance
- 0.01%/V line regulation
- 0.3% load regulation
- Min. 1.5A output current
- Available in hermetic TO-220

HIGH RELIABILITY FEATURES-SG117A/SG117

- Available to MIL-STD-883 and DSCC SMD
- MIL-M38510/11704BYA - JAN117K
- MIL-M38510/11703BXA - JAN117T
- LMI level "S" processing available

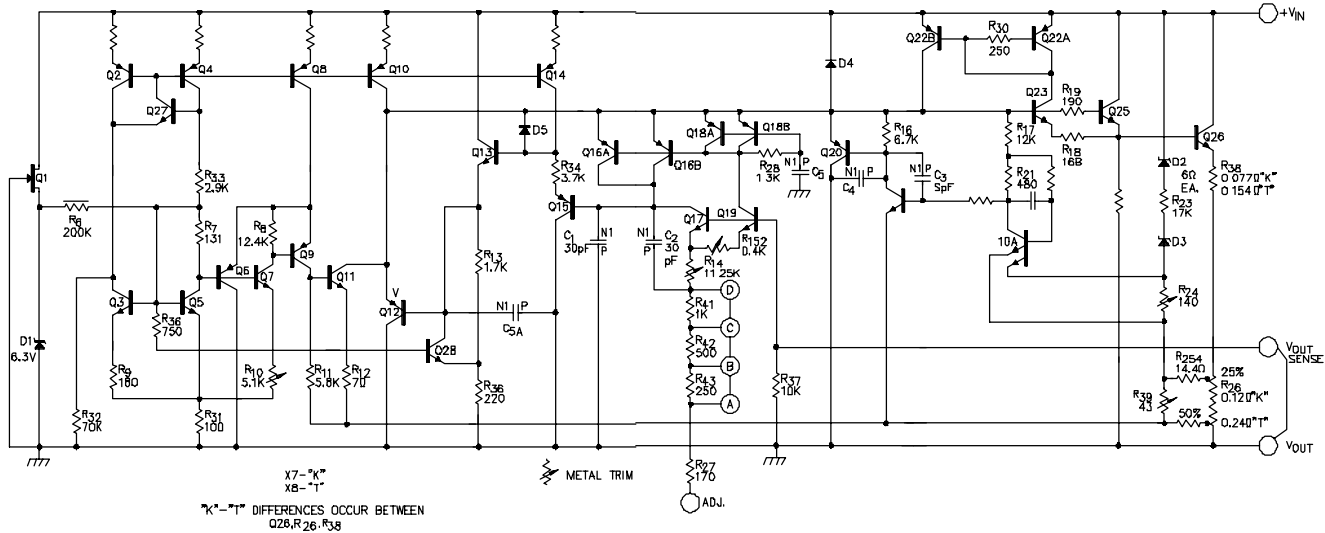
SCHEMATIC DIAGRAM

ABSOLUTE MAXIMUM RATINGS

Power Dissipation	Internally Limited
Input to Output Voltage Differential	40V
Storage Temperature Range	-65°C to 150°C
Operating Junction Temperature	150°C
Lead Temperature (Soldering 10 seconds).....	300°C

Note: Exceeding these ratings could cause damage to the device. All voltages are with respect to Ground. Currents are positive into, negative out of specified terminal.

THERMAL DATA
K 3 Terminal TO-3 Metal Can

THERMAL RESISTANCE-JUNCTION TO CASE, θ_{JC}	3.0°C/W
THERMAL RESISTANCE-JUNCTION TO AMBIENT, θ_{JA}	35°C/W

F 10-Pin Flatpack

THERMAL RESISTANCE-JUNCTION TO CASE, θ_{JC}	80°C/W
THERMAL RESISTANCE-JUNCTION TO AMBIENT, θ_{JA}	145°C/W

R 3 Terminal TO-66 Metal Can

THERMAL RESISTANCE-JUNCTION TO CASE, θ_{JC}	5.0°C/W
THERMAL RESISTANCE-JUNCTION TO AMBIENT, θ_{JA}	40°C/W

T 3-Pin TO-39 Metal Can

THERMAL RESISTANCE-JUNCTION TO CASE, θ_{JC}	15°C/W
THERMAL RESISTANCE-JUNCTION TO AMBIENT, θ_{JA}	120°C/W

G 3-Pin TO-257 Hermetic

THERMAL RESISTANCE-JUNCTION TO CASE, θ_{JC}	3.5°C/W
THERMAL RESISTANCE-JUNCTION TO AMBIENT, θ_{JA}	42°C/W

IG 3-Pin TO-257 Hermetic (Isolated)

THERMAL RESISTANCE-JUNCTION TO CASE, θ_{JC}	3.5°C/W
THERMAL RESISTANCE-JUNCTION TO AMBIENT, θ_{JA}	42°C/W

L 20-Pin Ceramic (LCC) Leadless

THERMAL RESISTANCE-JUNCTION TO CASE, θ_{JC}	35°C/W
THERMAL RESISTANCE-JUNCTION TO AMBIENT, θ_{JA}	120°C/W

Junction Temperature Calculation: $T_J = T_A + (P_D \times \theta_{JA})$.

The θ_{JA} numbers are guidelines for the thermal performance of the device/pc-board system. All of the above assume no ambient airflow.

RECOMMENDED OPERATING CONDITIONS

Parameter	SGx17x			Units
	Min	Typ	Max	
Input Voltage Range	$V_{OUT} + 3.5$		37	V
Operating Junction Temperature Range	SG117A / SG117	-55	150	°C
Operating Junction Temperature Range	SG217A / SG217	-25	150	°C
Operating Junction Temperature Range	SG317A / SG317	0	125	°C

Note 2: Range Over which the device is functional.

Note 3: These ratings are applicable for junction temperatures of less than 150°C

ELECTRICAL CHARACTERISTICS

Unless otherwise specified, these specifications apply over the full operating ambient temperature for the SG117A / SG117 with $-55^{\circ}\text{C} \leq T_A \leq 125^{\circ}\text{C}$, the SG217A / SG217 with $-25^{\circ}\text{C} \leq T_A \leq 85^{\circ}\text{C}$, and the SG317A / SG317 with $0^{\circ}\text{C} \leq T_A \leq 70^{\circ}\text{C}$, $V_{IN} - V_{OUT} = 5.0\text{V}$ and for $I_{OUT} = 500\text{mA}$ (K,R, G, and IG) and $I_{OUT} = 100\text{mA}$ (T, F, and L packages). Although power dissipation is internally limited, these specifications are applicable for power dissipations of 2W for the T and L packages, and 20W for the K, R, G, and IG packages. I_{MAX} is 1.5A for the K, R, G, and IG packages and 500m for the T, F, and L packages. Low duty cycle pulse testing techniques are used which maintains junction and case temperatures equal to the ambient temperature.

Parameter	Test Conditions	SG117A / SG217A			SG117 / SG217			Units
		Min	Typ	Max	Min	Typ	Max	
Reference Voltage	$I_{OUT} = 10\text{mA}$, $T_A = 25^{\circ}\text{C}$ $3\text{V} \leq (V_{IN} - V_{OUT}) \leq 40\text{V}$, $P \leq P_{MAX}$	1.238	1.250	1.262				V
Line Regulation (Note 4)	$10\text{mA} \leq I_{OUT} \leq I_{MAX}$ $3\text{V} \leq (V_{IN} - V_{OUT}) \leq 40\text{V}$, $I_L = 10\text{mA}$ $T_A = 25^{\circ}\text{C}$	1.225	1.250	1.270	1.20	1.25	1.30	V
	$T_A = T_{MIN}$ to T_{MAX}		0.005	0.01		0.1	0.02	%/V
			0.01	0.02		0.02	0.05	%/V
Load Regulation (Note 4)	$10\text{mA} \leq I_{OUT} \leq I_{MAX}$ $V_{OUT} \leq 5\text{V}$, $T_A = 25^{\circ}\text{C}$		5	15		5	15	mV
	$V_{OUT} > 5\text{V}$, $T_A = 25^{\circ}\text{C}$		0.1	0.3		0.1	0.3	%
	$V_{OUT} \leq 5\text{V}$		20	50		20	50	mV
	$V_{OUT} \geq 5\text{V}$		0.3	1		0.3	1	%
Thermal Regulation (Note 5)	$T_A = 25^{\circ}\text{C}$, 20ms pulse $V_{OUT} = 10\text{V}$, $f = 120\text{Hz}$ $C_{ADJ} = 1\mu\text{F}$, $T_A = 25^{\circ}\text{C}$		0.002	0.02		0.03	0.07	%/W
	$C_{ADJ} = 10\mu\text{F}$	66	65		66	65		dB
Adjust Pin Current			80			80		dB
Adjust Pin Current Change	$10\text{mA} < I_{OUT} < I_{MAX}$, $2.5\text{V} < (V_{IN} - V_{OUT}) < 40\text{V}$		50	100		50	100	μA
Minimum Load Current	$(V_{IN} - V_{OUT}) = 40\text{V}$		3.5	5		3.5	5	mA
Current Limit	$(V_{IN} - V_{OUT}) \leq 15\text{V}$ K, P, R, G, IG Packages	1.5	2.2		1.5	2.2		A
	T, L Packages	0.5	0.8		0.5	0.8		A
	$(V_{IN} - V_{OUT}) = 40\text{V}$, $T_J = 25^{\circ}\text{C}$ K, P, R, G, IG Packages	0.3	0.4		0.3	0.4		A
	T, L Packages	0.15	0.2		0.15	0.2		A
Temperature Stability (Note 5)			1	2		1		%
Long Term Stability (Note 5)	$T_A = 125^{\circ}\text{C}$, 1000 Hours		0.3	1		0.3	1	%
RMS Output Noise (% of V_{OUT})	$T_A = 25^{\circ}\text{C}$, $10\text{Hz} \leq f \leq 10\text{kHz}$ (Note 5)		0.001			0.001		%

ELECTRICAL CHARACTERISTICS (CONTINUED)

Unless otherwise specified, these specifications apply over the full operating ambient temperature for the SG117A / SG117 with $-55^{\circ}\text{C} \leq T_A \leq 125^{\circ}\text{C}$, the SG217A / SG217 with $-25^{\circ}\text{C} \leq T_A \leq 85^{\circ}\text{C}$, and the SG317A / SG317 with $0^{\circ}\text{C} \leq T_A \leq 70^{\circ}\text{C}$, $V_{\text{IN}} - V_{\text{OUT}} = 5.0\text{V}$ and for $I_{\text{OUT}} = 500\text{mA}$ (K, R, G, and IG) and $I_{\text{OUT}} = 100\text{mA}$ (T, F, and L packages). Although power dissipation is internally limited, these specifications are applicable for power dissipations of 2W for the T and L packages, and 20W for the K, R, G, and IG packages. I_{MAX} is 1.5A for the K, R, G, and IG packages and 500m for the T, F, and L packages. Low duty cycle pulse testing techniques are used which maintains junction and case temperatures equal to the ambient temperature.

Parameter	Test Conditions	SG317A			SG317			Units
		Min	Typ	Max	Min	Typ	Max	
Reference Voltage	$I_{\text{OUT}} = 10\text{mA}$, $T_A = 25^{\circ}\text{C}$ $3\text{V} \leq (V_{\text{IN}} - V_{\text{OUT}}) \leq 40\text{V}$, $P \leq P_{\text{MAX}}$	1.238	1.250	1.262				V
Line Regulation (Note 4)	$10\text{mA} \leq I_{\text{OUT}} \leq I_{\text{MAX}}$ $3\text{V} \leq (V_{\text{IN}} - V_{\text{OUT}}) \leq 40\text{V}$, $I_L = 10\text{mA}$ $T_A = 25^{\circ}\text{C}$	1.225	1.250	1.270	1.20	1.25	1.30	V
	$T_A = T_{\text{MIN}}$ to T_{MAX}		0.005	0.01		0.1	0.04	%/V
Load Regulation (Note 4)	$10\text{mA} \leq I_{\text{OUT}} \leq I_{\text{MAX}}$ $V_{\text{OUT}} \leq 5\text{V}$, $T_A = 25^{\circ}\text{C}$		5	25		5	25	mV
	$V_{\text{OUT}} > 5\text{V}$, $T_A = 25^{\circ}\text{C}$		0.1	0.5		0.1	0.5	%
Thermal Regulation (Note 5)	$V_{\text{OUT}} \leq 5\text{V}$		20	50		20	70	mV
	$V_{\text{OUT}} \geq 5\text{V}$		0.3	1		0.3	1.5	%
Ripple Rejection	$T_A = 25^{\circ}\text{C}$, 20ms pulse $V_{\text{OUT}} = 10\text{V}$, $f = 120\text{Hz}$ $C_{\text{ADJ}} = 1\mu\text{F}$, $T_A = 25^{\circ}\text{C}$		0.002	0.02		0.03	0.07	%/W
	$C_{\text{ADJ}} = 10\mu\text{F}$	66	80		66	80		dB
Adjust Pin Current	$T_A = 25^{\circ}\text{C}$		50	100		50	100	μA
Adjust Pin Current Change	$10\text{mA} < I_{\text{OUT}} < I_{\text{MAX}}$, $2.5\text{V} < (V_{\text{IN}} - V_{\text{OUT}}) < 40\text{V}$		0.2	5		0.2	5	μA
Minimum Load Current	$(V_{\text{IN}} - V_{\text{OUT}}) = 40\text{V}$		3.5	5		3.5	5	mA
Current Limit	$(V_{\text{IN}} - V_{\text{OUT}}) \leq 15\text{V}$ K, P, R, G, IG Packages	1.5	2.2		1.5	2.2		A
	T, L Packages	0.5	0.8		0.5	0.8		A
Temperature Stability (Note 5)	$(V_{\text{IN}} - V_{\text{OUT}}) = 40\text{V}$, $T_J = 25^{\circ}\text{C}$ K, P, R, G, IG Packages	0.3	0.4		0.3	0.4		A
	T, L Packages	0.15	0.2		0.15	0.2		A
Long Term Stability (Note 5)	$T_A = 125^{\circ}\text{C}$, 1000 Hours		0.3	1		0.3	1	%
RMS Output Noise (% of V_{OUT})	$T_A = 25^{\circ}\text{C}$, $10\text{Hz} \leq f \leq 10\text{kHz}$ (Note 5)		0.001			0.001		%

NOTES

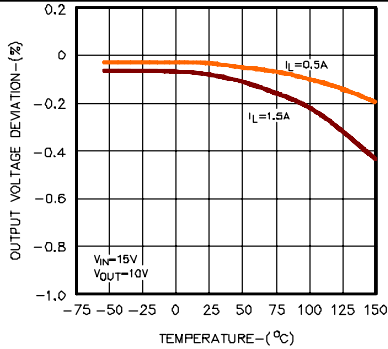
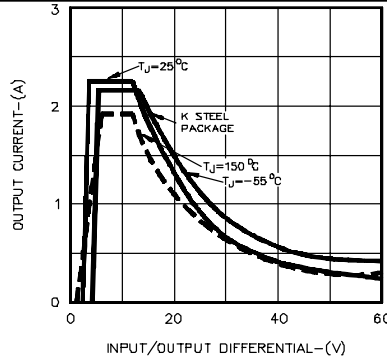
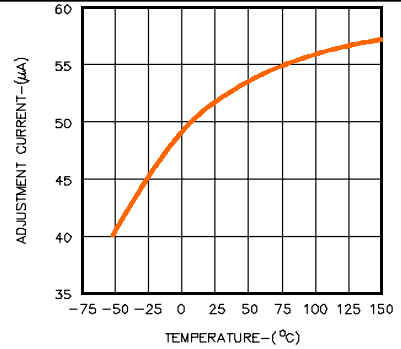
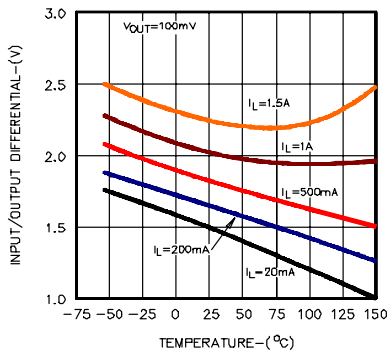
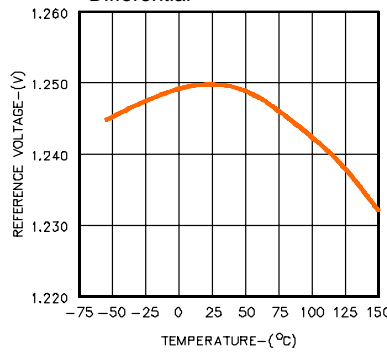
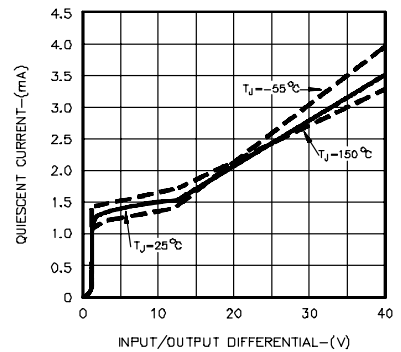
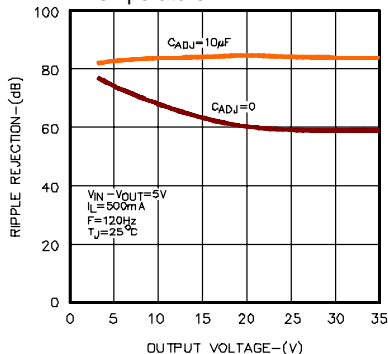
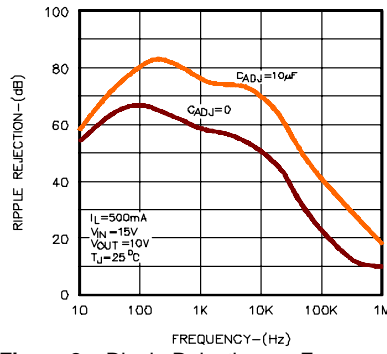
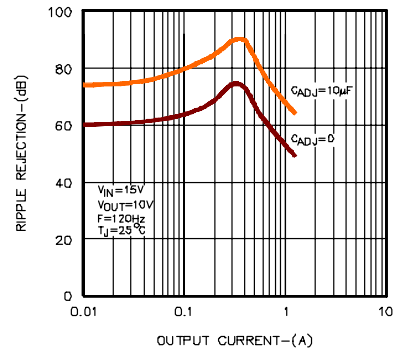
CHARACTERISTIC CURVES

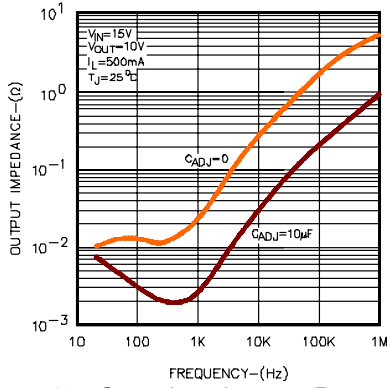
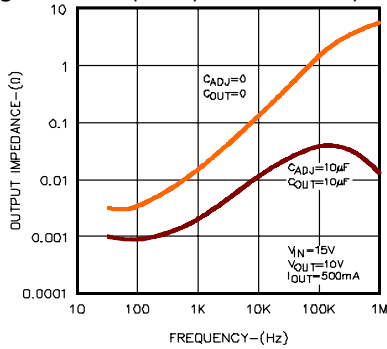
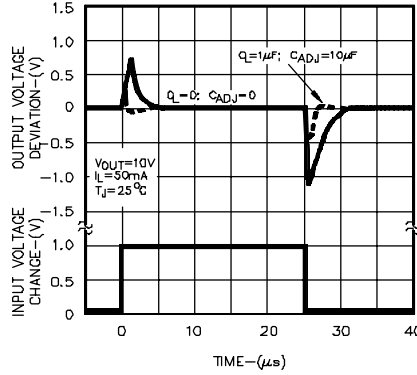
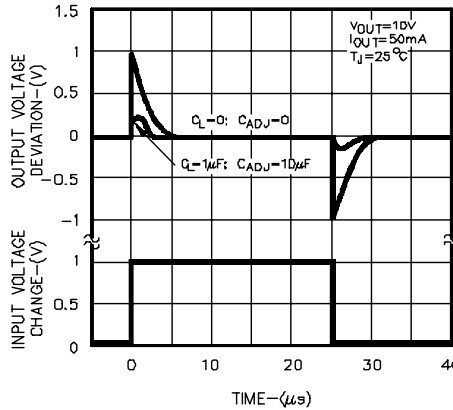
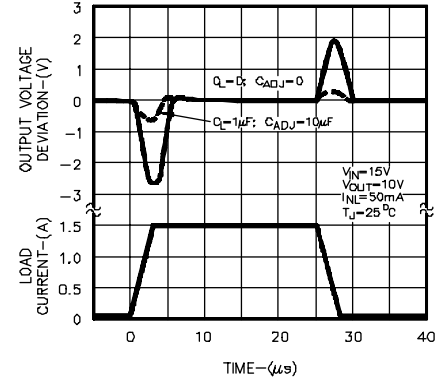
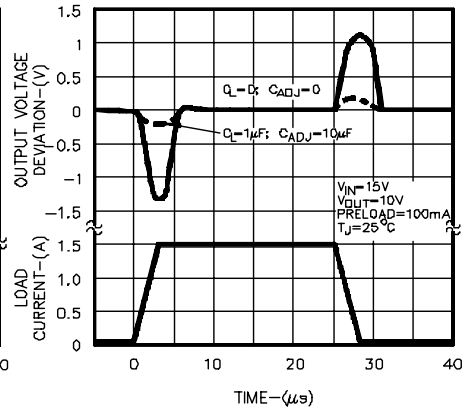
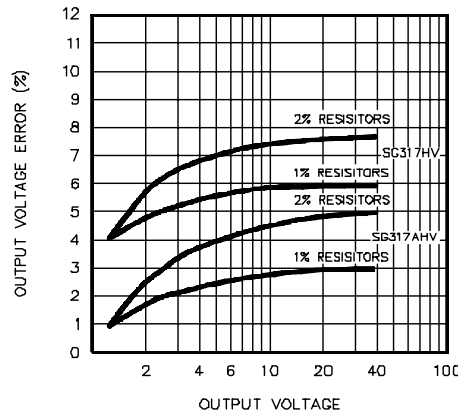
Figure 1 – Output Voltage Deviation vs. Temperature

Figure 2 – Output Current vs. Input / Output Differential

Figure 3 – Adjustable Current vs. Temperature

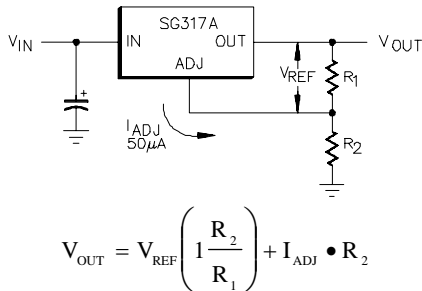
Figure 4 – Input / Output Differential vs. Temperature

Figure 5 – Reference Voltage vs. Temperature

Figure 6 – Quiescent Current vs. Input / Output Differential

Figure 7 – Ripple Rejection vs. Output Voltage

Figure 8 – Ripple Rejection vs. Frequency

Figure 9 – Ripple Rejection vs. Output Current

CHARACTERISTIC CURVES

Figure 10 – Output Impedance vs. Frequency

Figure 13 – Output Impedance vs. Frequency

Figure 11 – Line Transient Response

Figure 14 – Line Transient Response

Figure 12 – Load Transient Response

Figure 15 – Load Transient Response

Figure 16 – Output Voltage Error

APPLICATION INFORMATION
GENERAL

The SG117A develops a 1.25V reference voltage between the output and the adjustable terminal (see Figure 1). By placing a resistor, R₁ between these two terminals, a constant current is caused to flow through R₁ and down through R₂ to set the overall output voltage. Normally this current is the specified minimum load current of 5mA or 10mA.

Figure 17 – Basic Regulator Circuit

Because I_{ADJ} is very small and constant when compared with the current through R₁, it represents a small error and can usually be ignored.

It is easily seen from the above equation, that even if the resistors were of exact value, the accuracy of the output is limited by the accuracy of V_{REF}. Earlier adjustable regulators had a reference tolerance of ±4%. This tolerance is dangerously close to the ±5% supply tolerance required in many logic and analog systems. Further, many 1% resistors can drift 0.01% °C adding another 1% to the output voltage tolerance.

For example, using 2% resistors and ±4% tolerance for V_{REF}, calculations will show that the expected range of a 5V regulator design would be 4.66V ≤ V_{OUT} ≤ 5.36V or approximately ±7%. If the same example were used for a 15V regulator, the expected tolerance would be ±8%. With these results most applications require some method of trimming, usually a trim pot. This solution is expensive and not conducive to volume production.

One of the enhancements of Silicon General's adjustable regulators over existing devices is tightened initial tolerance. This allows relatively inexpensive 1% or 2% film resistors to be used for R₁ and R₂ while setting output voltage within an acceptable tolerance range.

With a guaranteed 1% reference, a 5V power supply design, using ±2% resistors, would have a worst case manufacturing tolerance of ±4%. If 1% resistors were used, the tolerance would drop to ±2.5%. A plot of the worst case output voltage tolerance as a function of resistor tolerance is shown on the front page.

For convenience, a table of standard 1% resistor values is shown below

Table of ½% and 1% Standard Resistance Values

1.00	1.47	2.15	3.16	4.64	6.81
1.02	1.50	2.21	3.24	4.75	6.98
1.05	1.54	2.26	3.32	4.87	7.15
1.07	1.58	2.32	3.40	4.99	7.32
1.10	1.62	2.37	3.48	5.11	7.50
1.13	1.65	2.43	3.57	5.23	7.68
1.15	1.69	2.49	3.65	5.36	7.87
1.18	1.74	2.55	3.74	5.49	8.06
1.21	1.78	2.61	3.83	5.62	8.25
1.24	1.82	2.67	3.92	5.76	8.45
1.27	1.87	2.74	4.02	5.90	8.66
1.30	1.91	2.80	4.12	6.04	8.87
1.33	1.96	2.87	4.22	6.19	9.09
1.37	2.00	2.94	4.32	6.34	9.31
1.40	2.05	3.01	4.42	6.49	9.53
1.43	2.10	3.09	4.53	6.65	9.76

Standard Resistance Values are obtained from the Decade Table by multiplying by multiples of 10. As an example: 1.21 can represent 1.21Ω, 12.1Ω, 121Ω, 1.21kΩ, etc.

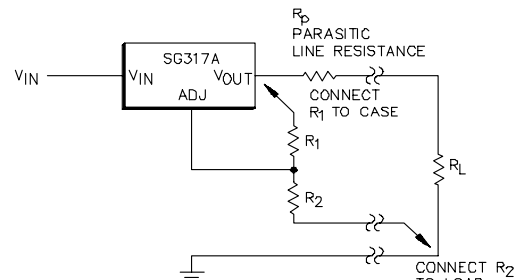
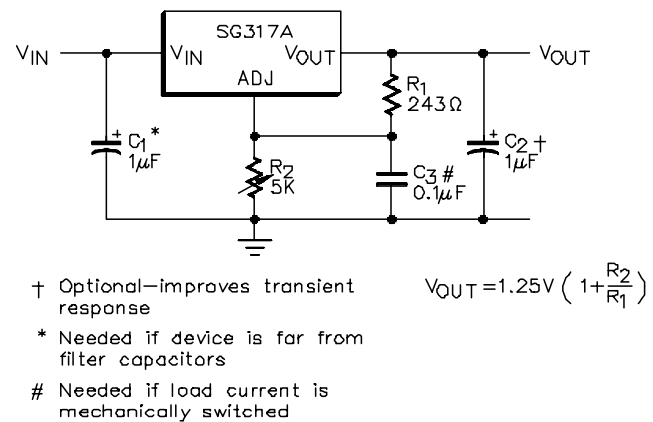
Figure 18 – Connections for Best Load Regulation

Figure 19 – 1.2V – 25V Adjustable Regulator

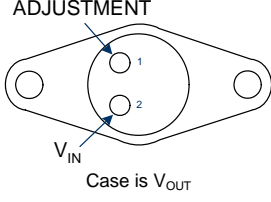
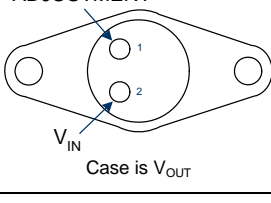
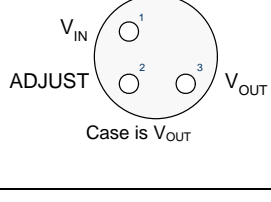
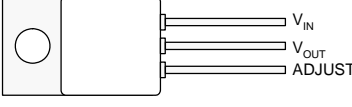
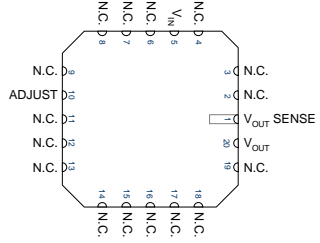
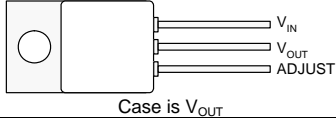
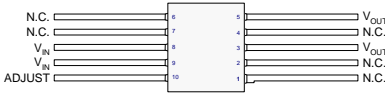
CONNECTION DIAGRAMS & ORDERING INFORMATION (SEE NOTES BELOW)

Package	Part No.	Ambient Temperature Range	Connection Diagram
3-Terminal TO-3 Metal Can K – Package	SG117AK/883B	-55°C to 125°C	 <p>ADJUSTMENT</p> <p>V_{IN}</p> <p>Case is V_{OUT}</p>
	SG117AK/DESC	-55°C to 125°C	
	SG117AK	-55°C to 125°C	
	SG217AK	-25°C to 85°C	
	SG317AK	0°C to 70°C	
	SG117K/883B	-55°C to 125°C	
	JAN117K	-55°C to 125°C	
	SG117K/DESC	-55°C to 125°C	
	SG117K	-55°C to 125°C	
	SG217K	-25°C to 85°C	
	SG317K	0°C to 70°C	
3-Pin TO-66 Metal Can R – Package	SG117AR/883B	-55°C to 125°C	 <p>ADJUSTMENT</p> <p>V_{IN}</p> <p>Case is V_{OUT}</p>
	SG117AR/DESC	-55°C to 125°C	
	SG117AR	-55°C to 125°C	
	SG217AR	-25°C to 85°C	
	SG317AR	0°C to 70°C	
	SG117R/883B	-55°C to 125°C	
	SG117AR/DESC	-55°C to 125°C	
	SG117R	-55°C to 125°C	
	SG217R	-25°C to 85°C	
	SG317R	0°C to 70°C	
3-Pin TO-39 Metal Can T – Package	SG117AT/883B	-55°C to 125°C	 <p>V_{IN}</p> <p>ADJUST</p> <p>V_{OUT}</p> <p>Case is V_{OUT}</p>
	SG117AT/DESC	-55°C to 125°C	
	SG117AT	-55°C to 125°C	
	SG217AT	-25°C to 85°C	
	SG317AT	0°C to 70°C	
	SG117T/883B	-55°C to 125°C	
	JAN117T	-55°C to 125°C	
	SG117T/DESC	-55°C to 125°C	
	SG117T	-55°C to 125°C	
	SG217T	-25°C to 85°C	
SG317T	0°C to 70°C		
3-Pin Hermetic TO-257 IG – Package (Isolated)	SG117AIG/883B	-55°C to 125°C	 <p>V_{IN}</p> <p>V_{OUT}</p> <p>ADJUST</p>
	SG117AIG/DESC	-55°C to 125°C	
	SG117AIG	-55°C to 125°C	
	SG117IG/883B	-55°C to 125°C	
	SG117IG/DESC	-55°C to 125°C	
	SG117IG	-55°C to 125°C	
20-Pin Ceramic (LCC) Leadless Chip Carrier L – Package	SG117AL/883B	-55°C to 125°C	 <p>ADJUST</p> <p>V_{OUT} SENSE</p> <p>V_{OUT}</p>
	SG117AL/DESC	-55°C to 125°C	
	SG117AL	-55°C to 125°C	
	SG117L/883B	-55°C to 125°C	
	SG117L/DESC	-55°C to 125°C	
	SG117L	-55°C to 125°C	
3-Pin Hermetic TO-257 G – Package (Case is V_{OUT})	SG117AG/883B	-55°C to 125°C	 <p>V_{IN}</p> <p>V_{OUT}</p> <p>ADJUST</p> <p>Case is V_{OUT}</p>
	SG117AG/DESC	-55°C to 125°C	
	SG117AG	-55°C to 125°C	
	SG117G/883B	-55°C to 125°C	
	SG117G	-55°C to 125°C	
10-Pin Flatpack F – Package	SG117AF	-55°C to 125°C	 <p>V_{OUT}</p> <p>V_{OUT}</p> <p>V_{IN}</p> <p>V_{IN}</p> <p>ADJUST</p>
	SG117AF/883B	-55°C to 125°C	
	SG117F	-55°C to 125°C	
	SG117F/883B	-55°C to 125°C	

Note

- 1: Contact factory for JAN and DESC product availability.
- 2: All parts are viewed from the top.
- 3: Both inputs and outputs must be externally connected together at the device terminals.
- 4: For normal operation, the SENSE pin must be externally connected to the load.