

TRANSIENT IMMUNE UNVOLTAGE SENSING CIRCUIT

PRODUCTION DATA SHEET

DESCRIPTION

The LX7001 is an improved undervoltage sensing circuit specifically designed for use as a reset controller in microprocessor-based systems. Today's complex miniaturized systems present difficult challenges to the system designer such as overcoming spurious noise problems. The LX7001 is optimized for systems that must be tolerant of high-speed power supply glitches caused by high-speed logic transitions and similar switching phenomena. The LX7001 offers a unique stage that couples glitch immunity with a micropower, ultra stable band-gap reference for precision sensing of undervoltage conditions. It offers the designer an

economical, space-efficient solution for low supply voltage detection when used in combination with a single pull-up resistor. Adding one capacitor offers the functionality of a programmable delay time after power returns. Additionally, the LX7001 offers excellent temperature stability. A high-quality trimmed voltage reference and bias circuit permit very accurate and repeatable undervoltage sensing. The remaining blocks consist of a comparator with hysteresis, high current clamping diode and open collector output stage capable of sinking up to 60mA. The LX7001's RESET output is specified to be fully functional at $V_{IN}=1V$.

IMPORTANT: For the most current data, consult MICROSEMI's website: <http://www.microsemi.com>

KEY FEATURES

- Fully Characterized, Transient Immune Input Stage (See Product Highlight)
- Monitors 5V Supplies (VTRIP=4.6V Typ.)
- Outputs Fully Defined At $V_{CC}=1V$
- Ultra-Low Supply Current (500 μ A Max. Over Temp)
- Temperature Compensated ICC For Extremely Stable Current Consumption
- μ P Reset Function Programmable With 1 External Resistor And Capacitor
- Comparator Hysteresis Prevents Output Oscillation
- Electrically Compatible With Motorola MC34064
- Pin-to-Pin Compatible With Motorola MC34064/MC34164

PRODUCT HIGHLIGHT

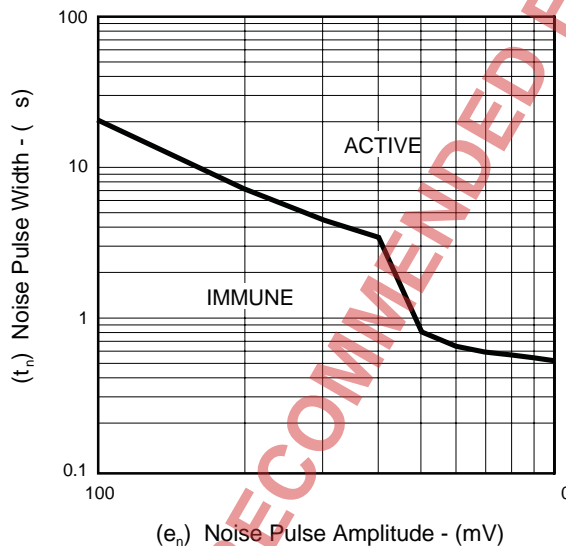

APPLICATIONS

- All Microprocessor Or Microcontroller Designs Using 5V Supplies
- Simple 5V Undervoltage Detection

PACKAGE ORDER INFO

T_A (°C)	DM Plastic SOIC 8-Pin RoHS Compliant / Pb-free Transition DC:0440	LP Plastic TO-92 3-Pin RoHS Compliant / Pb-free Transition DC:0509	Y Ceramic Dip 8-Pin
0 to 70	LX7001CDM	LX7001CLP	
-40 to 85	LX7001IDM	LX7001ILP	
-55 to 125			LX7001MY

Note: Available in Tape & Reel. Append the letters "TR" to the part number. (i.e. LX7001CDM-TR)

TRANSIENT IMMUNE UNDERVOLTAGE SENSING CIRCUIT

PRODUCTION DATA SHEET

ABSOLUTE MAXIMUM RATINGS (Note 1)

Input Supply Voltage (V_{IN})	-1V to 12V
\overline{RESET} Output Voltage (V_{OUT})	-1V to 12V
Output Sink Current (I_{OL})	Internally Limited (mA)
Clamp Diode Forward Current (I_F), Pin 1 to pin 2	100mA
Operating Junction Temperature	
Ceramic (Y - Package)	150°C
Plastic (DM, LP - Packages)	150°C
Storage Temperature Range	-65°C to 150°C
Lead Temperature (Soldering, 10 seconds)	300°C
Peak Package Solder Reflow Temp. (40 second max. exposure)	260°C(+0, -5)

Note 1. Values beyond which damage may occur. All voltages are specified with respect to ground, and all currents are positive into the specified terminal.

THERMAL DATA

DM PACKAGE:

THERMAL RESISTANCE-JUNCTION TO AMBIENT, θ_{JA}	165°C/W
---	---------

LP PACKAGE:

THERMAL RESISTANCE-JUNCTION TO AMBIENT, θ_{JA}	156°C/W
---	---------

Y PACKAGE:

THERMAL RESISTANCE-JUNCTION TO AMBIENT, θ_{JA}	130°C/W
---	---------

Junction Temperature Calculation: $T_J = T_A + (P_D \times \theta_{JA})$.

The θ_{JA} numbers are guidelines for the thermal performance of the device/pc-board system. All of the above assume no ambient airflow

PACKAGE PIN OUTS

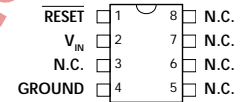

Y PACKAGE
(Top View)

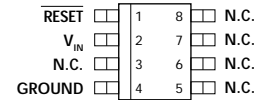

DM PACKAGE
(Top View)

RoHS / Pb-free 100% Matte Tin Lead Finish

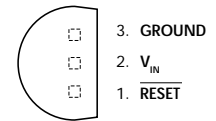

LP PACKAGE
(Top View)

RoHS / Pb-free 100% Matte Tin Lead Finish

NOT RECOMMENDED FOR NEW DESIGNS

TRANSIENT IMMUNE UNDERVOLTAGE SENSING CIRCUIT

PRODUCTION DATA SHEET

RECOMMENDED OPERATING CONDITIONS (Note 2)

Parameter	Symbol	Recommended Operating Conditions			Units
		Min.	Typ.	Max.	
Input Supply Voltage	V_{IN}	1		10	V
RESET Output Voltage	V_{OUT}		10		V
Clamp Diode Forward Current	I_F		50mA		
Operating Ambient Temperature Range:					
LX7001C		0		70	°C
LX7001I		-25		85	°C
LX7001M		-55		125	°C

Note 2. Range over which the device is functional.

ELECTRICAL CHARACTERISTICS

(Unless otherwise specified, these specifications apply over the operating ambient temperatures of $0^\circ\text{C} = T_A = 70^\circ\text{C}$ for the LX7001C, $-40^\circ\text{C} = T_A = 85^\circ\text{C}$ for the LX7001I, and $-55^\circ\text{C} = T_A = 125^\circ\text{C}$ for the LX7001M. Low duty cycle pulse testing techniques are used which maintains junction and case temperatures equal to the ambient temperature.)

Parameter	Symbol	Test Conditions	LX7001C/7001I/7001M			Units
			Min.	Typ.	Max.	
Comparator Section						
Threshold Voltage						
High State Output	V_{T+}	V_{IN} Increasing — 4V to 5V	4.5	4.62	4.7	V
Low State Output	V_{T-}	V_{IN} Decreasing — 5V to 4V	4.5	4.60	4.7	V
Hysteresis	V_H		0.01	0.02	0.05	V
RESET Output Section						
Output Sink Saturation Voltage	V_{OL}	$V_{IN} = 4.0\text{V}, I_{OL} = 8.0\text{mA}$		0.06	1.0	V
		$V_{IN} = 4.0\text{V}, I_{OL} = 2.0\text{mA}$		0.25	0.4	V
		$V_{IN} = 1.0\text{V}, I_{OL} = 0.1\text{mA}$		0.3	0.1	V
Output Sink Current	I_{OL}	$V_{OUT} = 4.0\text{V}$	10	40	60	mA
Output Off-State Leakage	I_{OH}	$V_{OUT} = 5.0\text{V}$		0.01	0.5	μA
		$V_{OUT} = 10\text{V}$			0.02	2.0
Clamp Diode Forward Voltage	V_F	Pin 1 to pin 2, $I_F = 10\text{mA}$	0.6	0.82	1.2	V
Total Device						
Supply Current	I_{CC}	$V_{IN} = 5.0\text{V}$		345	500	μA

BLOCK DIAGRAM

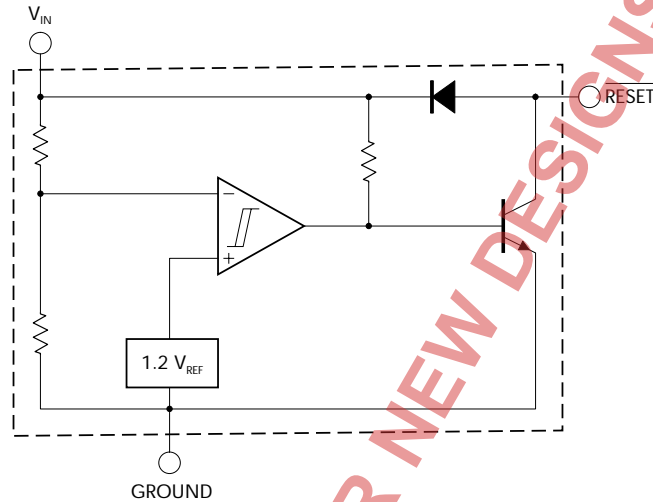

GRAPH / CURVE INDEX

Characteristic Curves

FIGURE

1. $\overline{\text{RESET}}$ OUTPUT VOLTAGE vs. INPUT VOLTAGE
2. POWER-UP $\overline{\text{RESET}}$ VOLTAGE
3. $\overline{\text{RESET}}$ OUTPUT VOLTAGE vs. INPUT VOLTAGE
4. THRESHOLD VOLTAGE vs. TEMPERATURE
5. THRESHOLD HYSTERESIS vs. TEMPERATURE
6. SUPPLY CURRENT vs. INPUT VOLTAGE
7. SUPPLY CURRENT vs. TEMPERATURE
8. LOW LEVEL OUTPUT CURRENT vs. TEMPERATURE
9. LOW LEVEL OUTPUT VOLTAGE vs. LOW LEVEL OUTPUT CURRENT
10. VOLTAGE vs. CLAMP DIODE FORWARD CURRENT
11. PROPAGATION DELAY
12. LOW LEVEL OUTPUT VOLTAGE vs. TEMPERATURE

FIGURE INDEX

Application Circuits

FIGURE

13. LOW VOLTAGE MICROPROCESSOR RESET
14. SWITCHING THE LOAD OFF WHEN BATTERY REACHES BELOW 4.3V
15. VOLTAGE MONITOR
16. MOSFET LOW VOLTAGE GATE DRIVE PROTECTION
17. LOW VOLTAGE MICROPROCESSOR RESET with ADDITIONAL HYSTERESIS

NOT RECOMMENDED FOR NEW DESIGNS

TRANSIENT IMMUNE UNDERVOLTAGE SENSING CIRCUIT

PRODUCTION DATA SHEET

CHARACTERISTIC CURVES

FIGURE 1. — $\overline{\text{RESET}}$ OUTPUT VOLTAGE vs. INPUT VOLTAGE

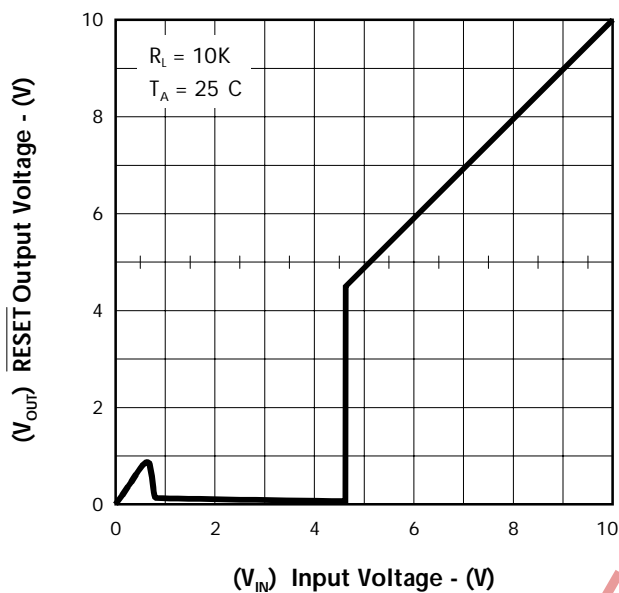

FIGURE 2. — POWER-UP $\overline{\text{RESET}}$ VOLTAGE

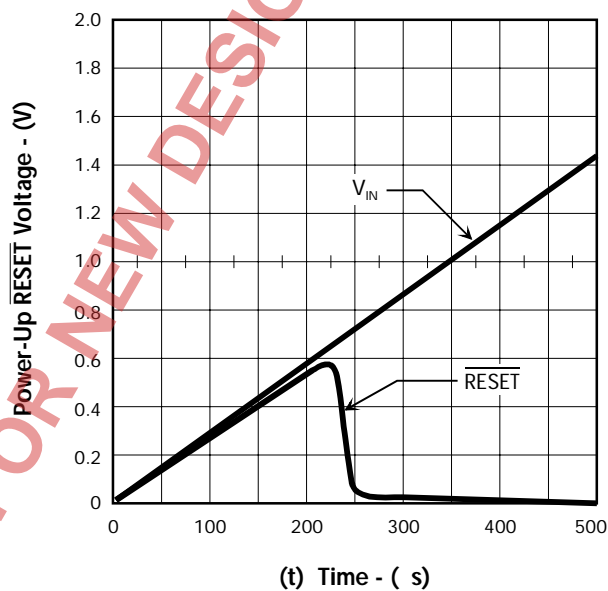

FIGURE 3. — $\overline{\text{RESET}}$ OUTPUT VOLTAGE vs. INPUT VOLTAGE

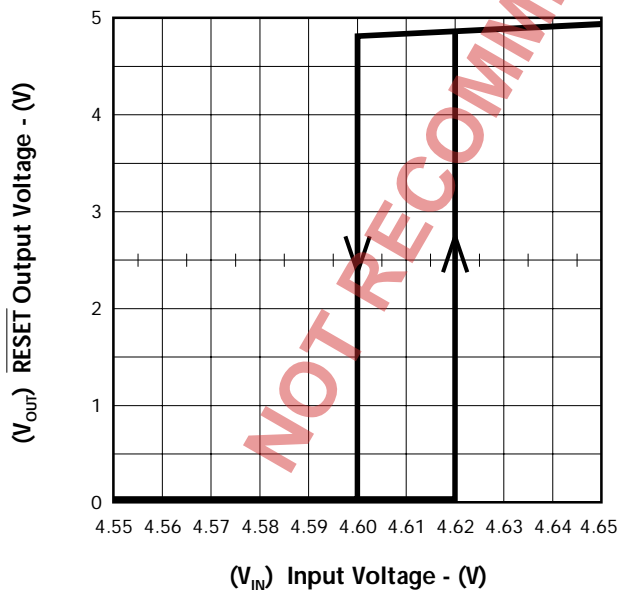
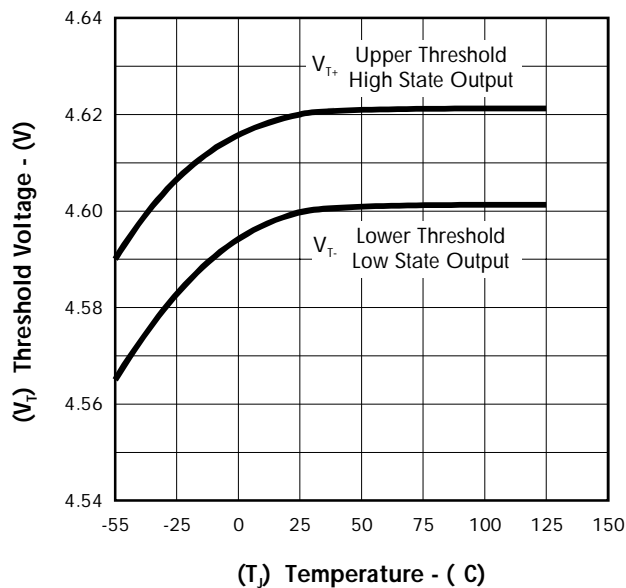

FIGURE 4. — THRESHOLD VOLTAGE vs. TEMPERATURE



CHARACTERISTIC CURVES

FIGURE 5. — THRESHOLD HYSTERESIS vs. TEMPERATURE

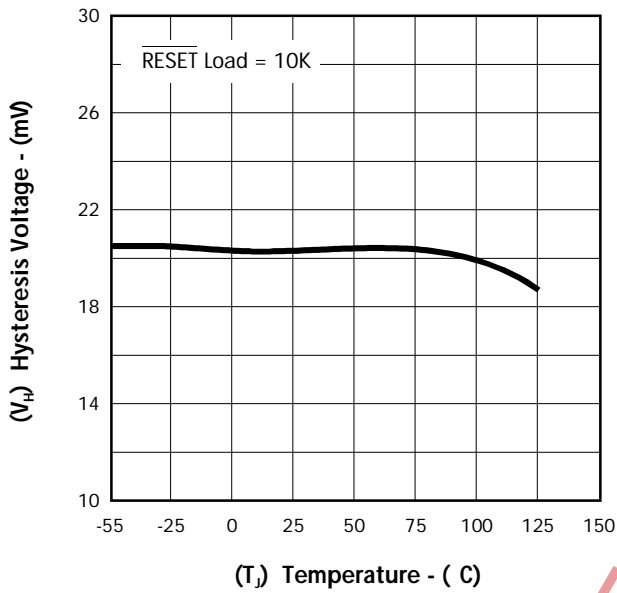

FIGURE 6. — SUPPLY CURRENT vs. INPUT VOLTAGE

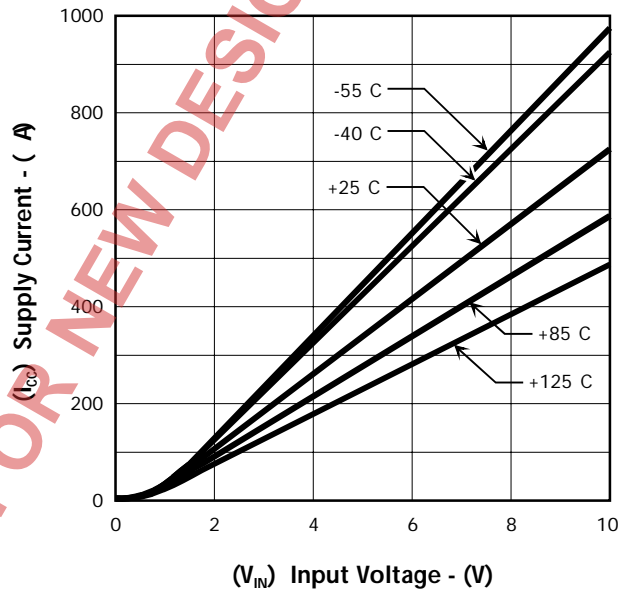

FIGURE 7. — SUPPLY CURRENT vs. TEMPERATURE

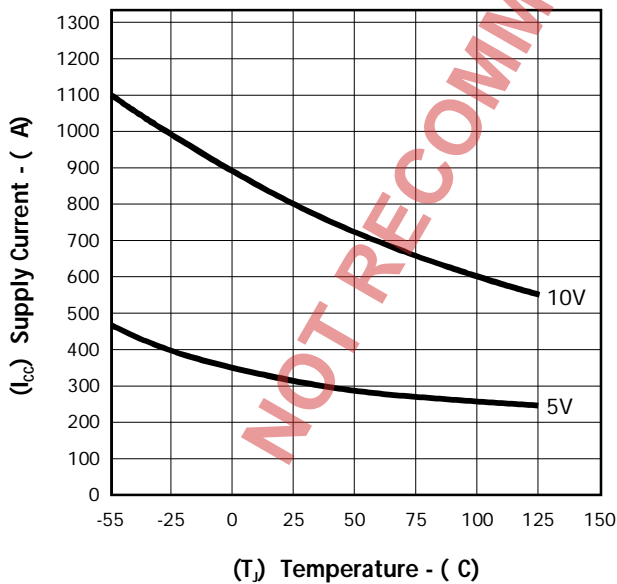
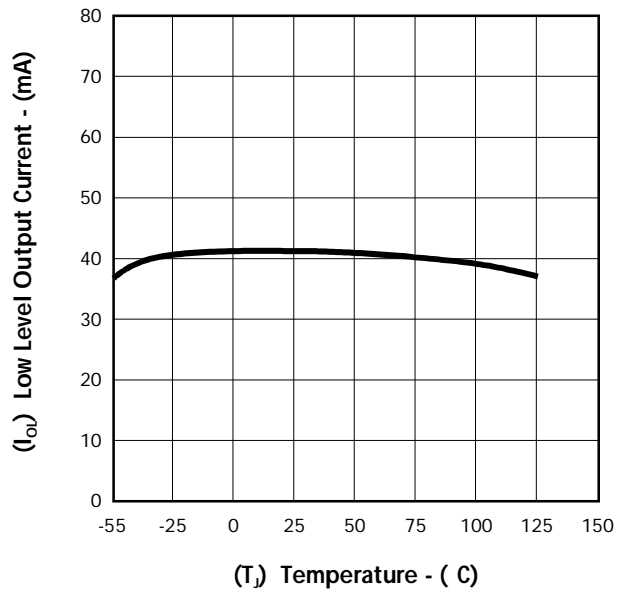

FIGURE 8. — LOW LEVEL OUTPUT CURRENT vs. TEMPERATURE



TRANSIENT IMMUNE UNDERVOLTAGE SENSING CIRCUIT

PRODUCTION DATA SHEET

CHARACTERISTIC CURVES

FIGURE 9. — LOW LEVEL OUTPUT VOLTAGE vs. LOW LEVEL OUTPUT CURRENT

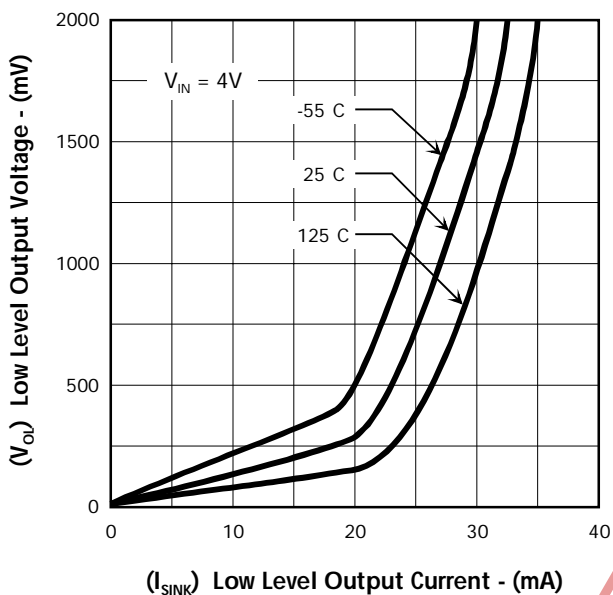

FIGURE 10. — VOLTAGE vs. CLAMP DIODE FORWARD CURRENT

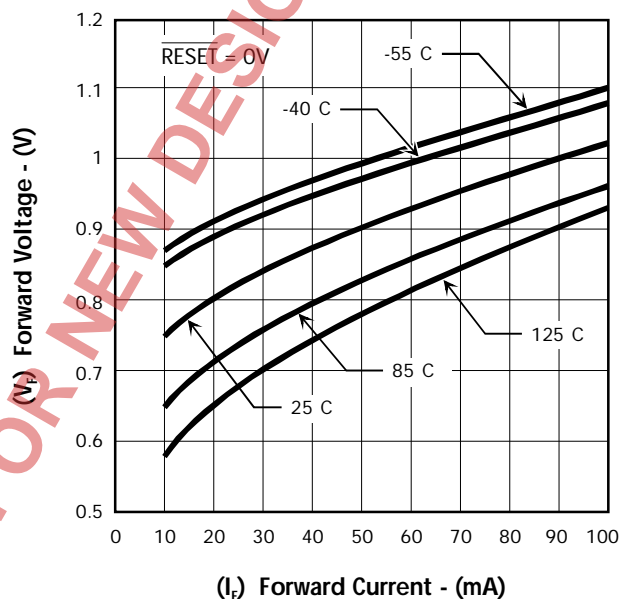

FIGURE 11. — PROPAGATION DELAY

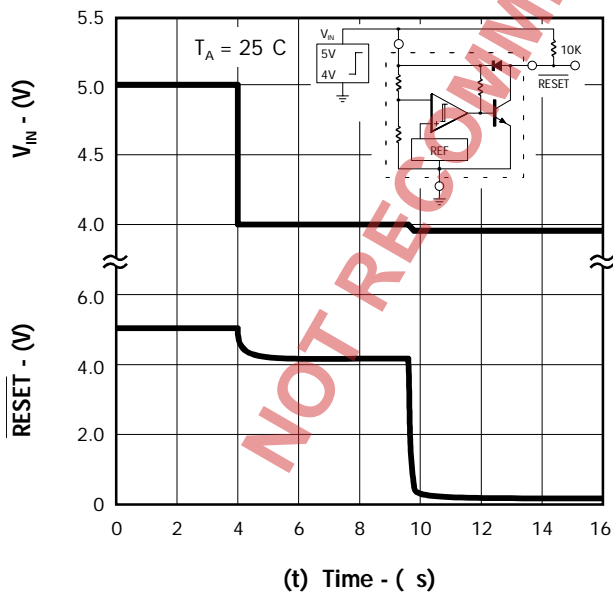
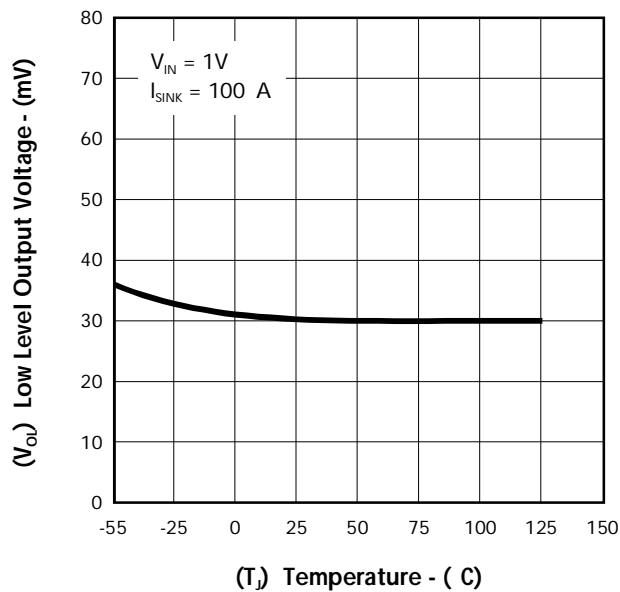
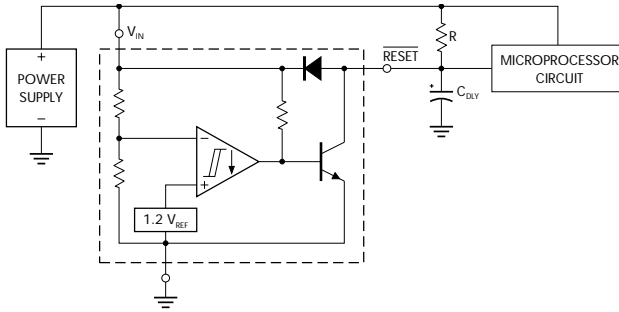

FIGURE 12. — LOW LEVEL OUTPUT VOLTAGE vs. TEMPERATURE



TYPICAL APPLICATION CIRCUITS

FIGURE 13. — LOW VOLTAGE MICROPROCESSOR RESET.



A time delayed reset can be accomplished with the addition of C_{DLY} . For systems with extremely fast power supply rise times ($< 500\text{ns}$) it is recommended that the RC_{DLY} time constant be greater than $5.0\mu\text{s}$. $V_{TH(MPU)}$ is the microprocessor reset input threshold.

$$t_{DLY} = R C_{DLY} \ln \left[\frac{1}{1 - \frac{V_{TH(MPU)}}{V_{IN}}} \right]$$

FIGURE 15. — VOLTAGE MONITOR.

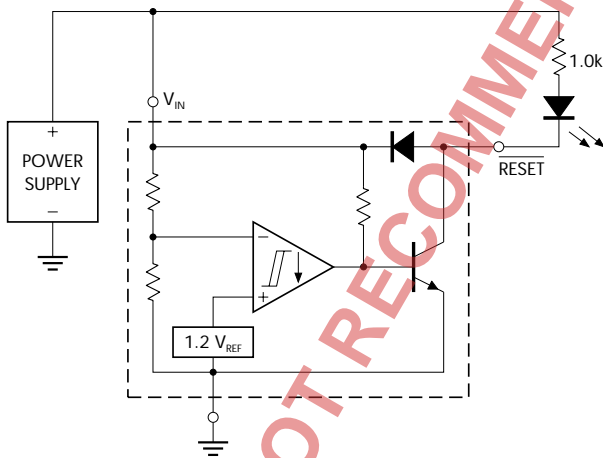

FIGURE 14. — SWITCHING THE LOAD OFF WHEN BATTERY REACHES BELOW 4.3V.

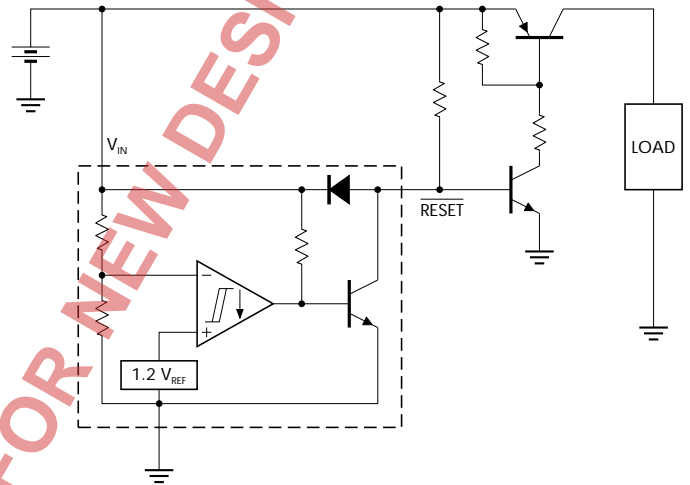
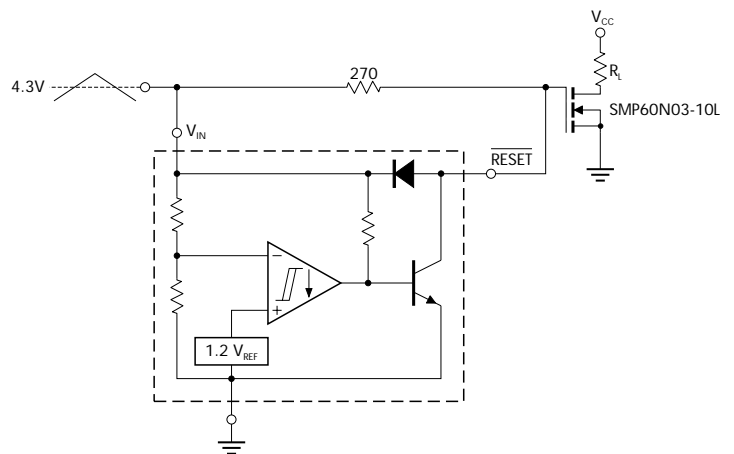

FIGURE 16. — MOSFET LOW VOLTAGE GATE DRIVE PROTECTION.



Overheating of the logic level power MOSFET due to insufficient gate voltage can be prevented with the above circuit. When the input signal is below the 4.3 volt threshold of the LX7001C, its output grounds the gate of the L² MOSFET.

TRANSIENT IMMUNE UNDERVOLTAGE SENSING CIRCUIT

PRODUCTION DATA SHEET

TYPICAL APPLICATION CIRCUITS (Con't.)

FIGURE 17. — LOW VOLTAGE MICROPROCESSOR RESET with ADDITIONAL HYSTERESIS.

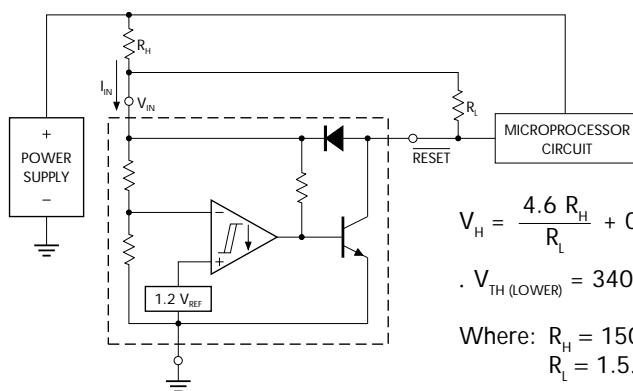

$$V_H = \frac{4.6 R_H}{R_L} + 0.02$$

$$V_{TH(LOWER)} = 340 R_H \times 10^{-6}$$

Where: $R_H = 150.$
 $R_L = 1.5. = 10k.$

Comparator hysteresis can be increased with the addition of resistor R_H . The hysteresis equation has been simplified and does not account for the change of input current I_{IN} as V_{CC} crosses the comparator threshold. An increase of the lower threshold $V_{TH(LOWER)}$ will be observed due to I_{IN} which is typically $340\mu A$ at $4.59V$. The equations are accurate to $\pm 10\%$ with R_H less than $150.$ and R_L between $1.5k.$ and $10k.$

TEST DATA			
V_H (mV)	V_{TH} (mV)	R_H (.)	R_L (.)
20	0	0	0
51	3.4	10	1.5
40	6.8	20	4.7
81	6.8	20	1.5
71	10	30	2.7
112	10	30	1.5
100	16	47	2.7
164	16	47	1.5
190	34	100	2.7
327	34	100	1.5
276	51	150	2.7
480	51	150	1.5

NOT RECOMMENDED FOR NEW DESIGNS

PRODUCTION DATA - Information contained in this document is proprietary to Linfinity, and is current as of publication date. This document may not be modified in any way without the express written consent of Linfinity. Product processing does not necessarily include testing of all parameters. Linfinity reserves the right to change the configuration and performance of the product and to discontinue product at any time.