

Precision Transimpedance Logarithmic Amplifier with Over 5 Decades of Dynamic Range

ABSOLUTE MAXIMUM RATINGS

(All voltages referenced to GND, unless otherwise noted.)

V _{CC}	-0.3V to +6V
V _{EE}	-6V to +0.3V
Supply Voltage (V _{CC} to V _{EE})	+12V
REFVOUT	(V _{EE} - 0.3V) to +3.0V
OSADJ, SCALE, REFISET	(V _{EE} - 0.3V) to +5.5V
REFIIN, LOGIIN	(V _{EE} - 0.3V) to V _{CMVIN}
LOGV1, LOGV2, CMVOUT, REFIOUT	(V _{EE} - 0.3V) to (V _{CC} + 0.3V)
CMVIN.....	(V _{EE} - 0.3V) to +1V

Continuous Current (REFIIN, LOGIIN)	10mA
Continuous Power Dissipation (T _A = +70°C) 16-Pin Thin QFN (derate 16.9mW/°C above +70°C) ...	1349mW
Operating Temperature Range	-40°C to +85°C
Junction Temperature	+150°C
Storage Temperature Range	-65°C to +150°C
Lead Temperature (soldering, 10s)	+300°C

Stresses beyond those listed under "Absolute Maximum Ratings" may cause permanent damage to the device. These are stress ratings only, and functional operation of the device at these or any other conditions beyond those indicated in the operational sections of the specifications is not implied. Exposure to absolute maximum rating conditions for extended periods may affect device reliability.

DC ELECTRICAL CHARACTERISTICS—Dual-Supply Operation

(V_{CC} = +5V, V_{EE} = -5V, GND = 0, I_{REF} = 1μA, I_{LOG} = 10μA, LOGV2 = SCALE, LOGV1 = OSADJ, CMVIN = CMVOUT, R_{SET} > 1MΩ, T_A = -40°C to +85°C. Typical values are at T_A = +25°C, unless otherwise noted.) (Note 1)

PARAMETER	SYMBOL	CONDITIONS		MIN	TYP	MAX	UNITS
Supply Voltage	V _{CC}	(Note 2)		2.7		5.5	V
	V _{EE}	(Note 2)		-2.7		-5.5	
Supply Current	I _{CC}	T _A = +25°C			5	6	mA
		T _A = -40°C to +85°C				7.5	
LOGIIN Current Range (Notes 3, 4)	I _{LOG}	Minimum		10			nA
		Maximum				1	mA
REFIIN Current Range (Notes 3, 4)	I _{REF}	Minimum		10			nA
		Maximum				1	mA
Common-Mode Voltage	V _{CMVOUT}				0		V
Common-Mode Voltage Input Range	V _{CMVIN}			0		0.5	V
Log Conformity Error	V _{LC}	I _{REF} = 10nA, I _{LOG} = 10nA to 1mA, K = -0.25V/decade (Note 4)	T _A = +25°C		±2	±5	mV
			T _A = -40°C to +85°C			±10	
Logarithmic Slope (Scale Factor)	K	T _A = +25°C		-237.5	-250	-262.5	mV/ decade
		T _A = -40°C to +85°C		-231.25		-268.75	
Logarithmic Slope (Scale Factor) Temperature Drift		T _A = -40°C to +85°C			80		μV/ decade/ °C
Input Offset Voltage	V _{IO}	T _A = +25°C, V _{CMVIN} - V _{REFIIN} , V _{CMVIN} - V _{LOGIIN}			0.6	5	mV
Input Offset Voltage Temperature Drift	V _{IOS}	V _{CMVIN} - V _{REFIIN} , V _{CMVIN} - V _{LOGIIN}			6		μV/°C
Voltage Reference Output	V _{REFVOUT}	T _A = +25°C		1.218	1.238	1.258	V
		T _A = -40°C to +85°C (Note 4)		1.195		1.275	

Precision Transimpedance Logarithmic Amplifier with Over 5 Decades of Dynamic Range

MAX4207

DC ELECTRICAL CHARACTERISTICS—Dual-Supply Operation (continued)

($V_{CC} = +5V$, $V_{EE} = -5V$, $GND = 0$, $I_{REF} = 1\mu A$, $I_{LOG} = 10\mu A$, $LOGV2 = SCALE$, $LOGV1 = OSADJ$, $CMVIN = CMVOUT$, $R_{SET} > 1M\Omega$, $T_A = -40^\circ C$ to $+85^\circ C$. Typical values are at $T_A = +25^\circ C$, unless otherwise noted.) (Note 1)

PARAMETER	SYMBOL	CONDITIONS	MIN	TYP	MAX	UNITS
Voltage Reference Output Current	$I_{REFVOUT}$			1		mA
Current Reference Output Voltage	$V_{REFISET}$	$T_A = +25^\circ C$	490	500	510	mV
		$T_A = -40^\circ C$ to $+85^\circ C$ (Note 4)	482		518	
LOGV2 BUFFER						
Input Offset Voltage	V_{IO}	$T_A = +25^\circ C$		0.4	2	mV
		$T_A = -40^\circ C$ to $+85^\circ C$ (Note 4)			6	
Input Bias Current	I_B	(Note 4)		0.01	1	nA
Output Voltage Range	V_{OH}	R_L to GND = $2k\Omega$		$V_{CC} - 0.2$	$V_{CC} - 0.3$	V
	V_{OL}	R_L to GND = $2k\Omega$	$V_{EE} + 0.2$	$V_{EE} + 0.08$		
Output Short-Circuit Current	I_{OUT+}	Sourcing		34		mA
	I_{OUT-}	Sinking		58		
Slew Rate	SR			12		V/ μs
Unity-Gain Bandwidth	GBW			5		MHz

AC ELECTRICAL CHARACTERISTICS—Dual-Supply Operation

($V_{CC} = +5V$, $V_{EE} = -5V$, $GND = 0$, $I_{REF} = 1\mu A$, $I_{LOG} = 10\mu A$, $LOGV2 = SCALE$, $LOGV1 = OSADJ$, $CMVIN = CMVOUT$, $R_{SET} > 1M\Omega$, $T_A = +25^\circ C$, unless otherwise noted.)

PARAMETER	SYMBOL	CONDITIONS	MIN	TYP	MAX	UNITS
LOGV2 Total Noise		0.1Hz to 10Hz, total output-referred noise, $I_{REF} = 10nA$, $I_{LOG} = 100nA$		17		μV_{RMS}
LOGV2 Spot Noise Density		$f = 5kHz$, $I_{REF} = 10nA$, $I_{LOG} = 100nA$		0.8		$\mu V/\sqrt{Hz}$
REFVOUT Total Noise		1Hz to 10Hz, total output-referred noise		3.3		μV_{RMS}
REFVOUT Spot Noise Density		$f = 5kHz$		266		nV/\sqrt{Hz}
REFISET Total Noise		1Hz to 10Hz, total output-referred noise		0.67		μV_{RMS}
REFISET Spot Noise Density		$f = 5kHz$		23		nV/\sqrt{Hz}
Small-Signal Unity-Gain Bandwidth		$I_{REF} = 1\mu A$, $I_{LOG} = 10\mu A$, $R_{COMP} = 300\Omega$, $C_{COMP} = 32pF$		1		MHz

Note 1: All devices are 100% production tested at $T_A = +25^\circ C$. All temperature limits are guaranteed by design.

Note 2: Guaranteed and functionally verified.

Note 3: Log conformity error less than $\pm 5mV$ with scale factor = $0.25V/decade$.

Note 4: Guaranteed by design.

Precision Transimpedance Logarithmic Amplifier with Over 5 Decades of Dynamic Range

Typical Operating Characteristics

($V_{CC} = +5V$, $V_{EE} = -5V$, $GND = 0V$, $I_{REF} = 1\mu A$, $I_{LOG} = 10\mu A$, $LOGV2 = SCALE$, $LOGV1 = OSADJ$, $CMVIN = CMVOUT$, $R_{SET} > 1M\Omega$, $T_A = +25^\circ C$, unless otherwise noted.)

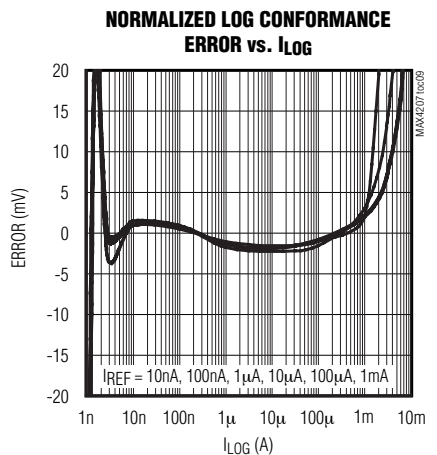
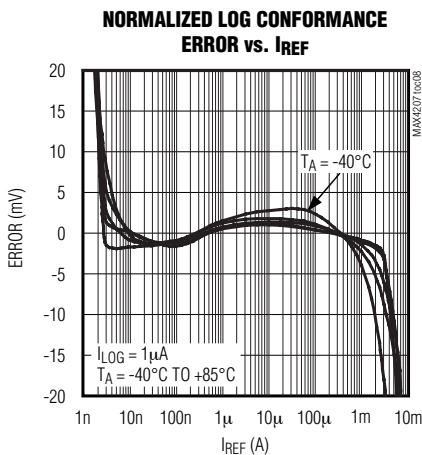
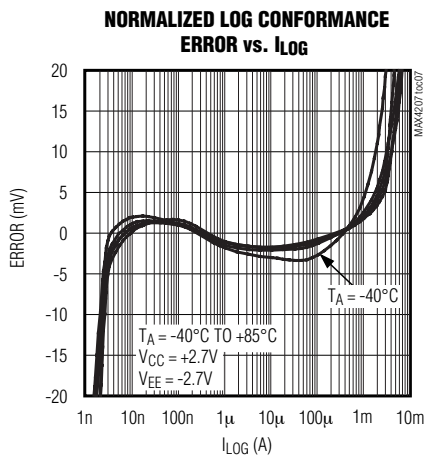
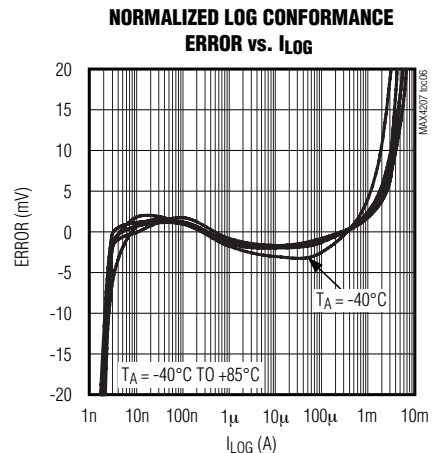
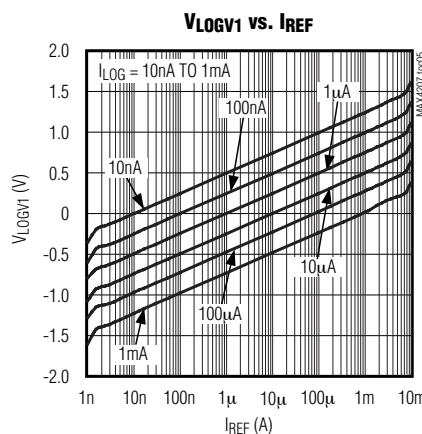
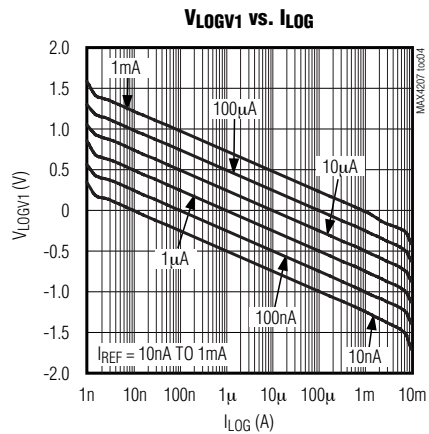
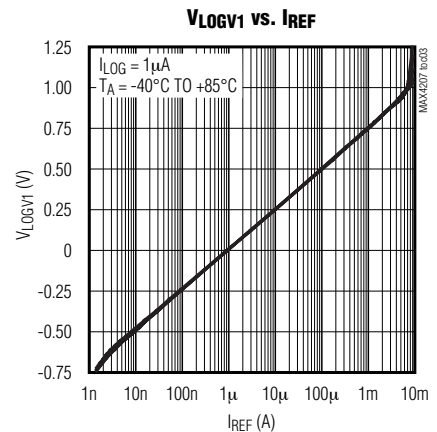
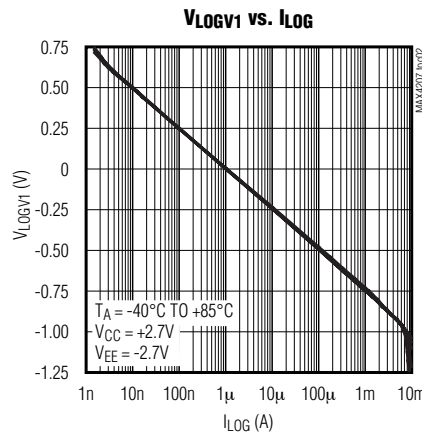
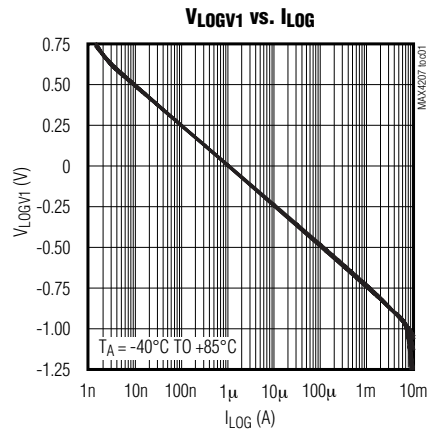

Precision Transimpedance Logarithmic Amplifier with Over 5 Decades of Dynamic Range

Typical Operating Characteristics (continued)

($V_{CC} = +5V$, $V_{EE} = -5V$, $GND = 0V$, $I_{REF} = 1\mu A$, $I_{LOG} = 10\mu A$, $LOGV2 = SCALE$, $LOGV1 = OSADJ$, $CMVIN = CMVOUT$, $R_{SET} > 1M\Omega$, $T_A = +25^\circ C$, unless otherwise noted.)

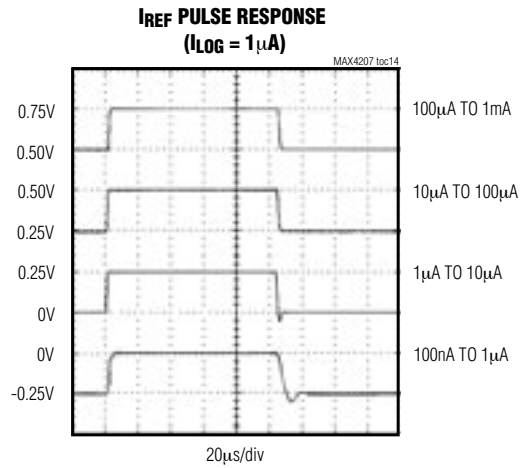
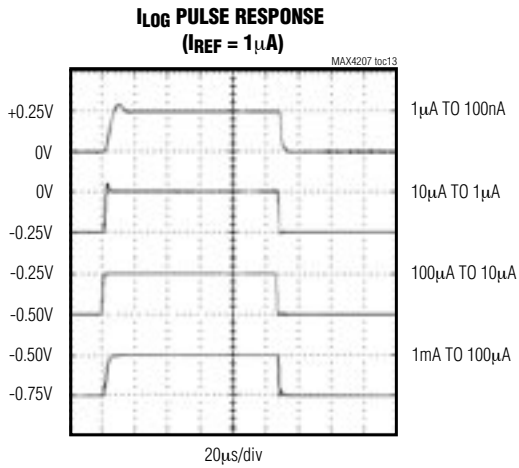
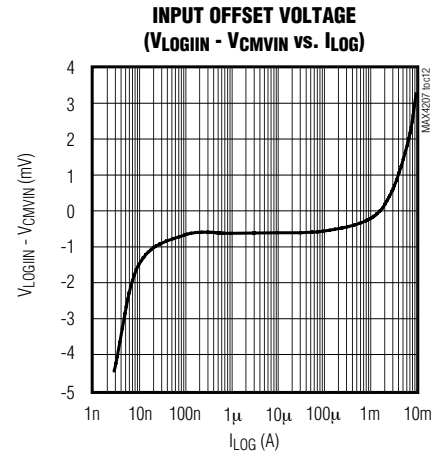
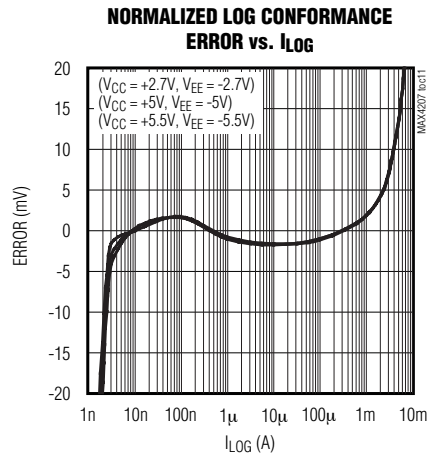
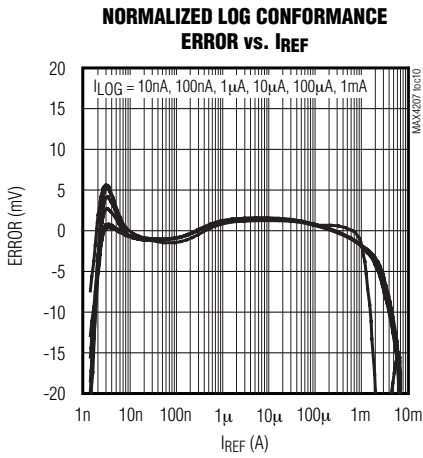

Precision Transimpedance Logarithmic Amplifier with Over 5 Decades of Dynamic Range

Typical Operating Characteristics (continued)

($V_{CC} = +5V$, $V_{EE} = -5V$, $GND = 0V$, $I_{REF} = 1\mu A$, $I_{LOG} = 10\mu A$, $LOGV2 = SCALE$, $LOGV1 = OSADJ$, $CMVIN = CMVOUT$, $R_{SET} > 1M\Omega$, $T_A = +25^\circ C$, unless otherwise noted.)

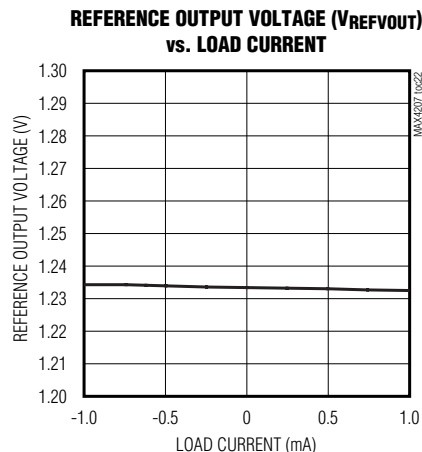
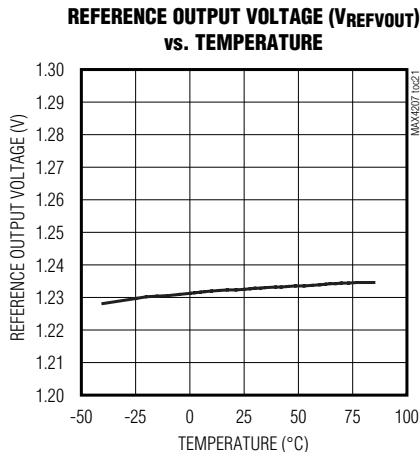
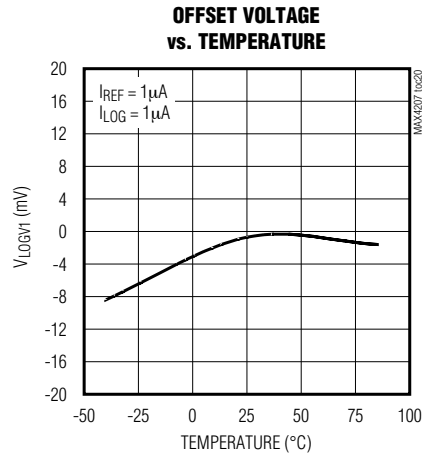
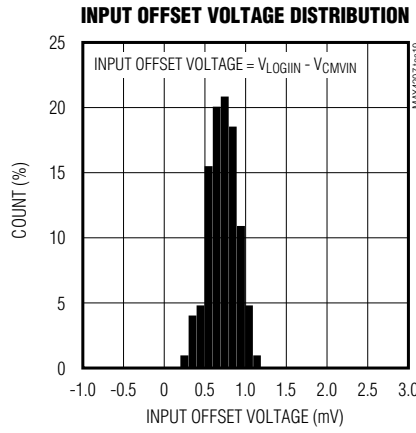
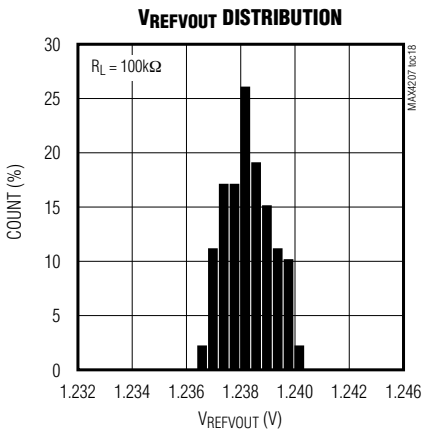
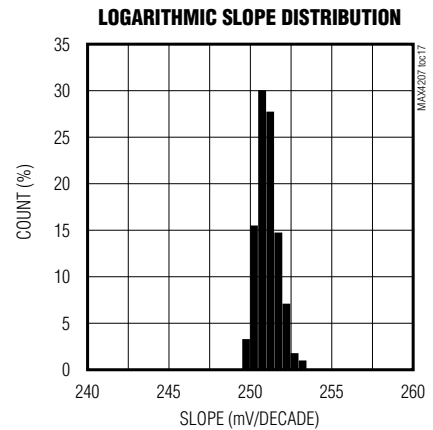
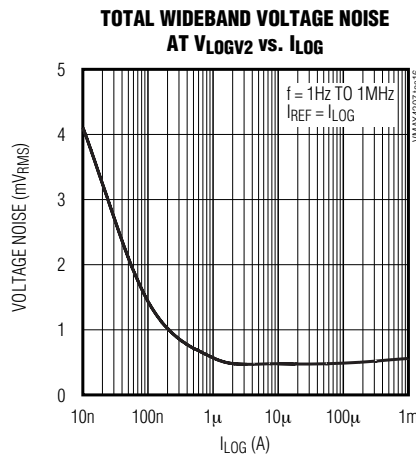
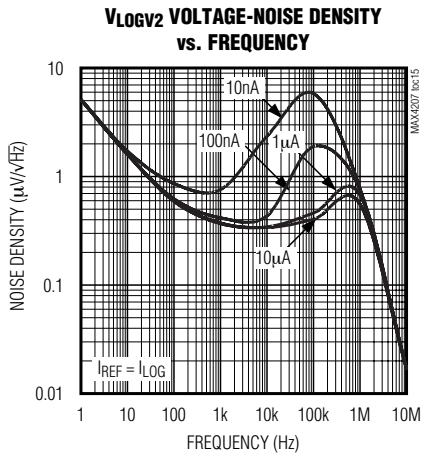

Precision Transimpedance Logarithmic Amplifier with Over 5 Decades of Dynamic Range

MAX4207

Typical Operating Characteristics (continued)

($V_{CC} = +5V$, $V_{EE} = -5V$, $GND = 0V$, $I_{REF} = 1\mu A$, $I_{LOG} = 10\mu A$, $LOGV2 = SCALE$, $LOGV1 = OSADJ$, $CMVIN = CMVOUT$, $R_{SET} > 1M\Omega$, $T_A = +25^\circ C$, unless otherwise noted.)

REFERENCE OUTPUT VOLTAGE ($V_{REFVOUT}$) vs. SUPPLY VOLTAGE ($V_{CC} - V_{EE}$)

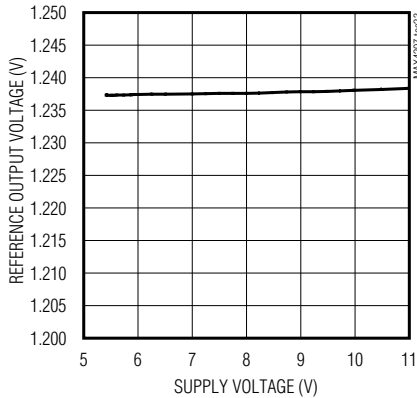

REFERENCE POWER-SUPPLY REJECTION RATIO vs. FREQUENCY

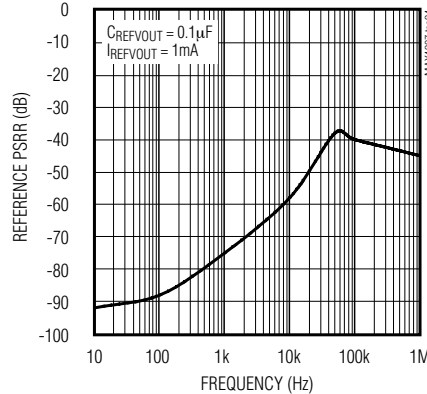

REFERENCE LINE-TRANSIENT RESPONSE

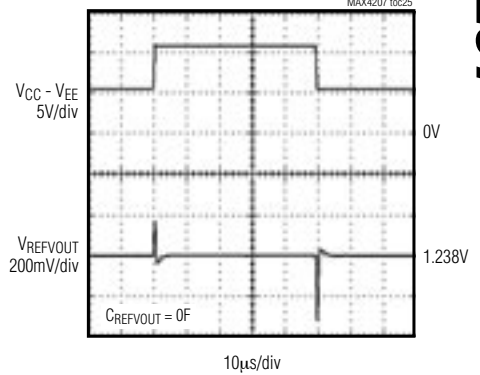

REFERENCE LOAD-TRANSIENT RESPONSE

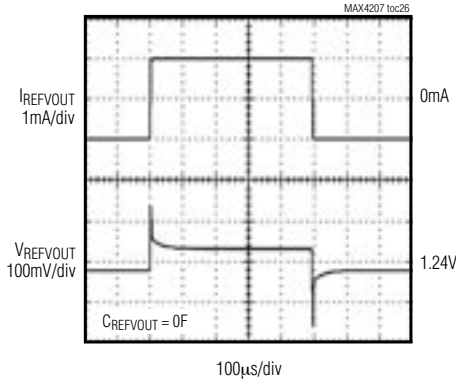

REFERENCE TURN-ON TRANSIENT RESPONSE

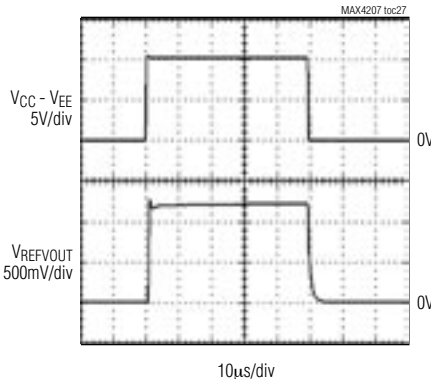

SMALL-SIGNAL AC RESPONSE (I_{LOG} TO V_{LOGV1})

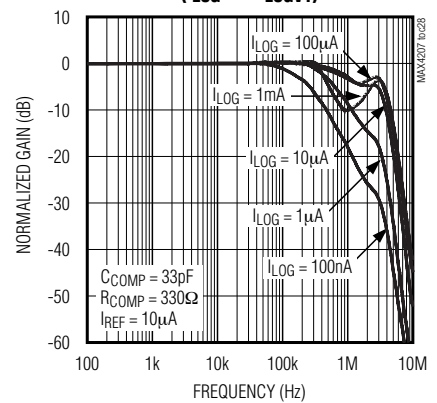

SMALL-SIGNAL AC RESPONSE (I_{LOG} TO V_{LOGV1})

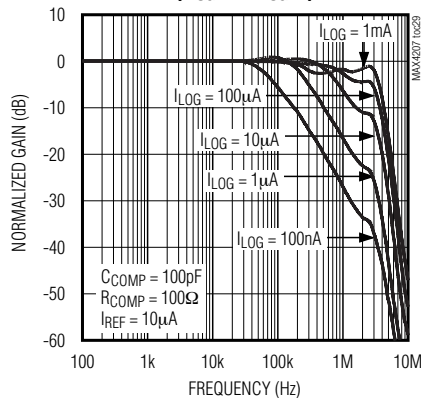

SMALL-SIGNAL AC RESPONSE OF BUFFER

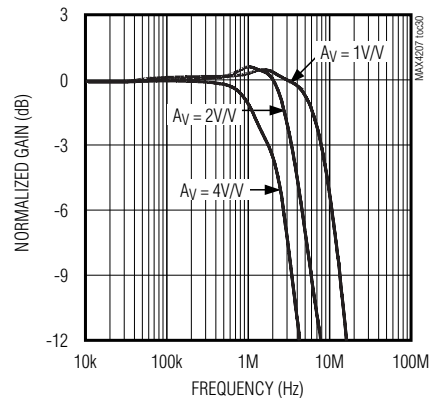

Precision Transimpedance Logarithmic Amplifier with Over 5 Decades of Dynamic Range

Pin Description

PIN	NAME	FUNCTION
1, 9	N.C.	No Connection. Not internally connected.
2	REFVOUT	1.238V Reference Voltage Output. Bypass REFVOUT to GND with a 0 to 1 μ F capacitor (optional).
3	GND	Ground
4	VEE	Negative Power Supply. Bypass VEE to GND with a 0.1 μ F capacitor.
5	LOGV1	Logarithmic Amplifier Voltage Output 1. The output scale factor of LOGV1 is -0.25V/decade.
6	OSADJ	Offset Adjust Input. Apply a voltage at OSADJ to adjust the LOGV2 output offset voltage (see the <i>Output Offset</i> section).
7	SCALE	Scale Factor Input. Adjust the output scale factor for LOGV2 using a resistive divider (see the <i>Scale Factor</i> section).
8	LOGV2	Logarithmic Amplifier Voltage Output 2. Adjust the output scale factor for LOGV2 using a resistive divider between SCALE, GND, and LOGV2 (see the <i>Scale Factor</i> section).
10	VCC	Positive Power Supply. Bypass VCC to GND with a 0.1 μ F capacitor.
11	REFISET	Current Reference Adjust Input. A resistor (R _{SET}), from REFISET to GND, adjusts the current at REFIOUT (see the <i>Adjusting the Logarithmic Intercept</i> section).
12	CMVOUT	0V Common-Mode Voltage Reference Output
13	REFIOUT	Current Reference Output. The internal current reference output is available at REFIOUT.
14	REFIIN	Current Reference Input. Apply an external reference current at REFIIN. I _{REFIIN} is the reference current used by the logarithmic amplifier when generating LOGV1.
15	LOGIIN	Current Input to Logarithmic Amplifier. LOGIIN is typically connected to a photodiode anode or other external current source.
16	CMVIN	Common-Mode Voltage Input. V _{CMVIN} is the common-mode voltage for the input and reference amplifiers (see the <i>Common Mode</i> section).

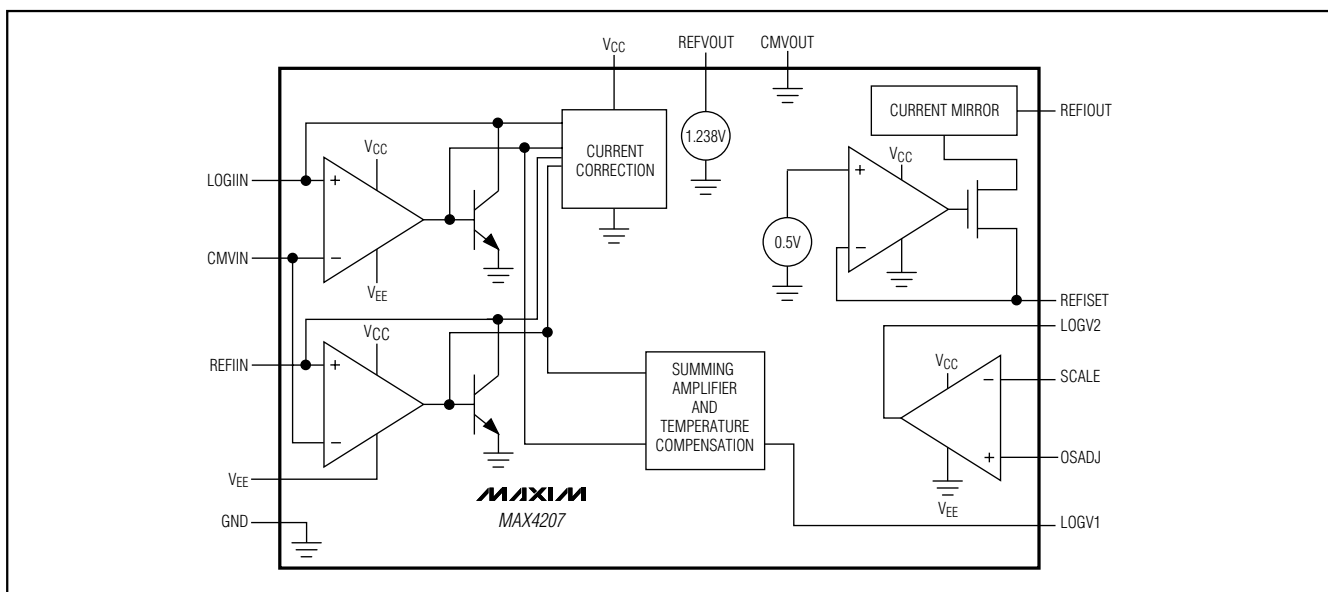

Figure 1. Functional Diagram

Precision Transimpedance Logarithmic Amplifier with Over 5 Decades of Dynamic Range

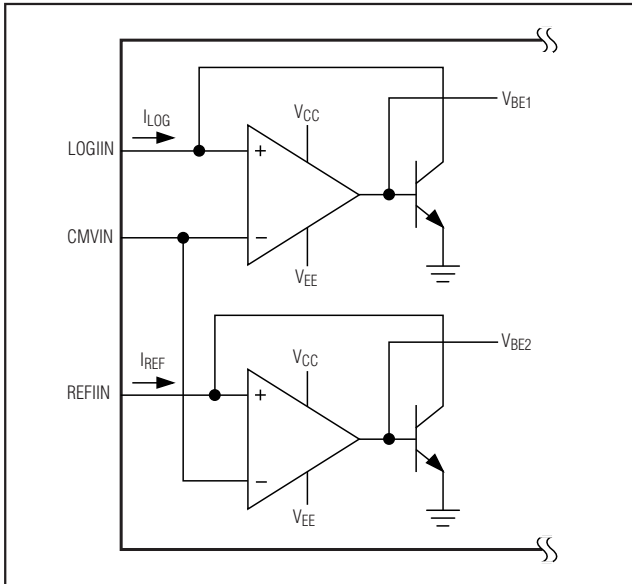

Figure 2. Simplified Model of a Logarithmic Amplifier

Detailed Description

Theory

Figure 2 shows a simplified model of a logarithmic amplifier. Two transistors convert the currents applied at LOGIIN and REFIIN to logarithmic voltages according to the following equation:

$$V_{BE} = \left(\frac{kT}{q}\right) \ln\left(\frac{I_C}{I_S}\right)$$

where:

V_{BE} = base-emitter voltage of a bipolar transistor

$k = 1.381 \times 10^{-23}$ J/K

T = absolute temperature (K)

$q = 1.602 \times 10^{-19}$ C

I_C = collector current

I_S = reverse saturation current

The logarithmic amplifier compares V_{BE1} to the reference voltage V_{BE2} , which is a logarithmic voltage for a known reference current, I_{REF} . The temperature dependencies of a logarithmic amplifier relate to the thermal voltage, (kT/q) , and I_S . Matched transistors eliminate the I_S temperature dependence of the amplifier in the following manner:

$$\begin{aligned} V_{OUT} &= V_{BE1} - V_{BE2} \\ &= \left(\frac{kT}{q}\right) \ln\left[\left(\frac{I_{LOG}}{I_S}\right) - \left(\frac{kT}{q}\right) \ln\left(\frac{I_{REF}}{I_S}\right)\right] \\ &= \left(\frac{kT}{q}\right) \left[\ln\left(\frac{I_{LOG}}{I_S}\right) - \ln\left(\frac{I_{REF}}{I_S}\right)\right] \\ &= \left(\frac{kT}{q}\right) \left[\ln\left(\frac{I_{LOG}}{I_{REF}}\right)\right] \\ &= \left(\frac{kT}{q}\right) (\ln(10)) \left[\log_{10}\left(\frac{I_{LOG}}{I_{REF}}\right)\right] \\ &= K \times \log_{10}\left(\frac{I_{LOG}}{I_{REF}}\right) \end{aligned} \quad \text{(see Figure 3)}$$

where:

k = scale factor (V/decade)

I_{LOG} = the input current at LOGIIN

I_{REF} = the reference current at REFIIN

The MAX4207 uses internal temperature compensation to virtually eliminate the effects of the thermal voltage, (kT/q) , on the amplifier's scale factor, maintaining a constant slope over temperature.

Definitions

Transfer Function

The ideal logarithmic amplifier transfer function is:

$$V_{IDEAL} = K \times \log_{10}\left(\frac{I_{LOG}}{I_{REF}}\right)$$

Adjust K (see the *Scale Factor* section) to increase the transfer-function slope as illustrated in Figure 3. Adjust I_{REF} using REFISET (see the *Adjusting the Logarithmic Intercept* section) to shift the logarithmic intercept to the left or right as illustrated in Figure 4.

Log Conformity

Log conformity is the maximum deviation of the MAX4207's output from the best-fit straight line of the V_{LOGV1} versus $\log(I_{LOG}/I_{REF})$ curve. It is expressed as a percent of the full-scale output or an output voltage.

Referred-to-Input and Referred-to-Output Errors

The log nature of the MAX4207 insures that any additive error at LOGV1 corresponds to multiplicative error at the input, regardless of input level.

Precision Transimpedance Logarithmic Amplifier with Over 5 Decades of Dynamic Range

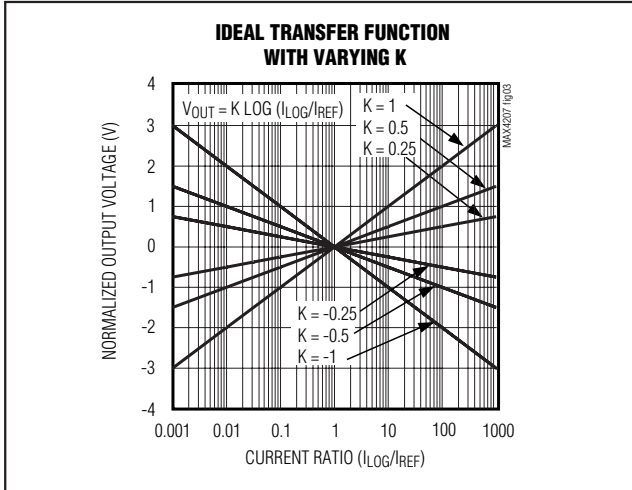

Figure 3. Ideal Transfer Function with Varying K

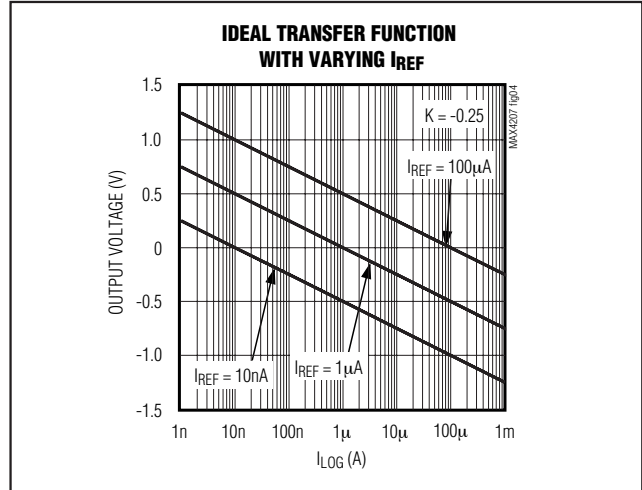

Figure 4. Ideal Transfer Function with Varying I_REF

Total Error

Total error (TE) is defined as the deviation of the output voltage, V_{LOGV1} , from the ideal transfer function (see the *Transfer Function* section):

$$V_{LOGV1} = V_{IDEAL} \pm TE$$

TE is a combination of the associated gain, input offset current, input bias current, output offset voltage, and transfer characteristic nonlinearity (log conformity) errors:

$$V_{LOGV2} = K(1 \pm \Delta K) \left[\log_{10} \left(\frac{I_{LOG} - I_{BIAS1}}{I_{REF} - I_{BIAS2}} \right) \pm 4(\pm V_{LC} \pm V_{OSOUT}) \right]$$

where V_{LC} and V_{OSOUT} are the log conformity and output offset voltages, respectively. Output offset is defined as the offset occurring at the output of the MAX4207 when equal currents are presented to I_{LOG} and I_{REF} . Because the MAX4207 is configured with a gain of $K = -0.25V/decade$, a 4 should multiply the $(\pm V_{LC} \pm V_{OSOUT})$ term, if V_{LC} and V_{OSOUT} were derived from this default configuration.

I_{BIAS1} and I_{BIAS2} are currents in the order of 20pA, significantly smaller than I_{LOG} and I_{REF} , and can therefore be eliminated:

$$V_{LOGV2} \approx K(1 \pm \Delta K) \left[\log_{10} \left(\frac{I_{LOG}}{I_{REF}} \right) \pm 4(\pm V_{LC} \pm V_{OSOUT}) \right]$$

Expanding this expression:

$$V_{LOGV2} \approx K \log_{10} \left(\frac{I_{LOG}}{I_{REF}} \right) \pm \Delta K \log_{10} \left(\frac{I_{LOG}}{I_{REF}} \right) \pm 4K(1 \pm \Delta K)(\pm V_{LC} \pm V_{OSOUT})$$

The first term of this expression is the ideal component of V_{LOGV1} . The remainder of the expression is the TE:

$$TE \approx \pm \Delta K \log_{10} \left(\frac{I_{LOG}}{I_{REF}} \right) \pm 4K(1 \pm \Delta K)(\pm V_{LC} \pm V_{OSOUT})$$

In the second term, one can generally remove the products relating to ΔK , because ΔK is generally much less than 1. Hence, a good approximation for TE is given by:

$$TE \approx \pm K \left[\Delta K \log_{10} \left(\frac{I_{LOG}}{I_{REF}} \right) \pm 4(\pm V_{LC} \pm V_{OSOUT}) \right]$$

As an example, consider the following situation:

Full-scale input = 5V

$I_{LOG} = 100\mu A$

$I_{REF} = 100nA$

$K = 1 \pm 5\% V/decade$ (note that the uncommitted amplifier is configured for a gain of 4)

$V_{LC} = \pm 5mV$ (obtained from the *Electrical Characteristics* table)

$V_{OSOUT} = \pm 2mV$ (typ), and $T_A = +25^\circ C$.

Precision Transimpedance Logarithmic Amplifier with Over 5 Decades of Dynamic Range

Substituting into the TE approximation,

$$TE \approx \pm (1V/\text{decade})(0.05 \log_{10} (100\mu A/100nA) \pm 4 (\pm 5mV \pm 2mV) = \pm [0.15V \pm 4(\pm 7mV)]$$

As a worst case, one finds $TE \approx \pm 178mV$ or $\pm 3.6\%$ of full scale.

When expressed as a voltage, TE increases in proportion with an increase in gain as the contributing errors are defined at a specific gain. Calibration using a look-up table eliminates the effects of gain and output offset errors, leaving conformity error as the only factor contributing to total error. For further accuracy, consider temperature monitoring as part of the calibration process.

Applications Information

Input Current Range

Five decades of input current across a 10nA to 1mA range are acceptable for I_{LOG} and I_{REF} . The effects of bias currents increase as I_{LOG} and I_{REF} fall below 10nA. Bandwidth decreases at low I_{LOG} values (see the *Frequency Response and Noise Considerations* section). As I_{LOG} and I_{REF} increase to 1mA or higher, transistors become less logarithmic in nature. The MAX4207 incorporates leakage current compensation and high-current correction circuits to compensate for these errors.

Frequency Compensation

The MAX4207's frequency response is a function of the input current magnitude and the selected compensation network at LOGIIN and REFIIN. The compensation network comprised of C_{COMP} and R_{COMP} ensures stability over the specified range of input currents by introducing an additional pole/zero to the system. For the typical application, select $C_{COMP} = 32pF$ and $R_{COMP} = 330\Omega$.

Frequency Response and Noise Considerations

The MAX4207 bandwidth is proportional to the magnitude of the I_{REF} and I_{LOG} currents, whereas the noise is inversely proportional to I_{REF} and I_{LOG} currents.

Common Mode

A 0V common-mode input voltage, V_{CMVOUT} , is available at CMVOUT and can be used to bias the logging and reference amplifier inputs by connecting CMVOUT to CMVIN. A voltage between 0 and 0.5V, connected to CMVIN, may be used to bias the logging and reference transistor collectors, thereby optimizing performance.

Adjusting the Logarithmic Intercept

Adjust the logarithmic intercept by changing the reference current, I_{REF} . A resistor from REFISSET to GND (see Figure 5) adjusts the reference current, according to the following equation:

$$R_{SET} = \frac{V_{REFISSET}}{10 \times I_{REF}}$$

where $V_{REFISSET}$ is 0.5V. Select R_{SET} between 5k Ω and 5M Ω . REFIOU current range is 10nA to 10 μ A only.

Dual-Supply Operation

The MAX4207 operates only from dual ± 2.7 to $\pm 5.5V$ supplies. The relationship of inputs to outputs is a function of I_{REF} , relative to I_{LOG} , and the configuration of the uncommitted amplifier. The uncommitted amplifier can be configured in either inverting or noninverting mode. In an inverting configuration, the uncommitted amplifier output, LOGV2, is positive and LOGV1 is negative when I_{LOG} exceeds I_{REF} . When operating in a noninverting configuration, LOGV2 and LOGV1 are both negative when I_{LOG} exceeds I_{REF} (see Table 1). An inverting configuration of the uncommitted buffer is recommended when large output offset voltage adjustments are required using OSADJ. By connecting CMVOUT and CMVIN, the log and reference amplifier inputs (LOGIIN and REFIIN) are biased at 0V. Applying the external voltage (0 to 0.5V) to CMVIN optimizes the application's performance.

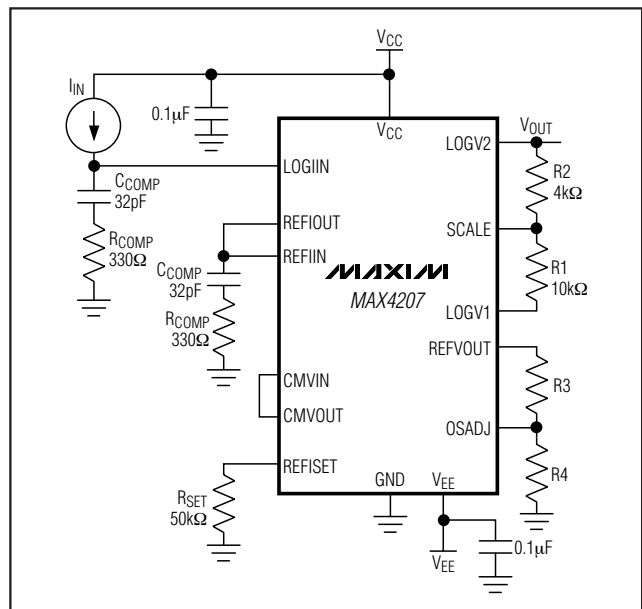

Figure 5. Typical Operating Circuit

Precision Transimpedance Logarithmic Amplifier with Over 5 Decades of Dynamic Range

Table 1. MAX4207 Example Configurations

LOGV2 AMPLIFIER CONFIGURATION	INPUT CONDITIONS	V _{LOGV1}	V _{LOGV2}
Inverting	I _{LOG} > I _{REF} (constant)	Negative	Positive
	I _{LOG} < I _{REF} (constant)	Positive	Negative
Noninverting	I _{LOG} > I _{REF} (constant)	Negative	Negative
	I _{LOG} < I _{REF} (constant)	Positive	Positive

Output Offset

The inverting configuration utilized by the MAX4207 facilitates large output-offset voltage adjustments. The magnitude of the offset voltage is given by the following equation:

$$V_{OS} = V_{OSADJ} \left(1 + \frac{R_2}{R_1} \right)$$

A resistive divider between REFVOUT, OSADJ, and GND can be used to adjust V_{OSADJ} (see Figure 5).

$$V_{OSADJ} = V_{REFOUT} \left(\frac{R_4}{R_3 + R_4} \right)$$

Scale Factor

The scale factor, K, is the slope of the logarithmic output. For the LOGV1 amplifier, K = -0.25V/decade. Adjust the overall scale factor for the MAX4207 using the uncommitted LOGV2 amplifier and the following equation, which refers to Figure 5:

$$R_2 = R_1 \left| \frac{K}{-0.25} \right|$$

Select R₂ between 1kΩ and 100kΩ.

Design Example

Desired:

Logarithmic intercept: 1μA

Overall scale factor = +1V/decade

$$R_{SET} = \frac{0.5V}{10 \times 1\mu A} = 50k\Omega$$

Select R₁ = 10kΩ:

$$R_2 = 10k\Omega \times \left| \frac{1V/decade}{-0.25} \right| = 40k\Omega$$

Photodiode Current Monitoring

Figure 6 shows the MAX4207 in an optical-power measurement circuit, common in fiberoptic applications. The MAX4007 current monitor converts the sensed APD current to an output current that drives the MAX4207 LOGIIN input (APD current is scaled by 0.1). The MAX4007 also buffers the high-voltage APD voltages from the lower MAX4207 voltages. The MAX4207's internal current reference sources 10nA (R_{SET} = 5MΩ) to the REFIIN input. This configuration sets the logarithmic intercept to 10nA, corresponding to an APD current of 100nA. The unity-gain configuration of the output buffer maintains the -0.25V/decade gain present at the LOGV1 output.

Measuring Optical Absorbance

A photodiode provides a convenient means of measuring optical power, as diode current is proportional to the incident optical power. Measure absolute optical power using a single photodiode connected at LOGIIN, with the MAX4207's internal current reference driving REFIIN. Alternatively, connect a photodiode to each of the MAX4207's logging inputs, LOGIIN and REFIIN, to measure relative optical power (Figure 7).

In absorbance measurement instrumentation, a reference light source is split into two paths. The unfiltered path is incident upon the photodiode of the reference channel, REFIIN. The other path passes through a sample of interest, with the resulting filtered light incident on the photodiode of the second channel, LOGIIN. The MAX4207 outputs provide voltages proportional to the log ratio of the two optical powers—an indicator of the optical absorbance of the sample.

In wavelength-locking applications, often found in fiberoptic communication modules, two photodiode currents provide a means of determining whether a given optical channel is tuned to the desired optical frequency. In this application, two bandpass optical filters with overlapping "skirts" precede each photodiode. With proper filter selection, the MAX4207 output can vary monotonically (ideally linearly) with optical frequency.

Precision Transimpedance Logarithmic Amplifier with Over 5 Decades of Dynamic Range

Layout and Bypassing

Bypass V_{CC} and V_{EE} to GND with ceramic 0.1 μ F capacitors. Place the capacitors as close to the device as possible. Bypass REFVOUT and/or CMVOUT to GND with a 0.1 μ F ceramic capacitor for increased noise immunity and a clean reference current. For low-current operation, it is recommended to use metal guard rings around LOGIIN, REFIIN, and REFISSET. Connect this guard ring to CMVOUT.

Chip Information

TRANSISTOR COUNT: 754

PROCESS: BiCMOS

Precision Transimpedance Logarithmic Amplifier with Over 5 Decades of Dynamic Range

Package Information

(The package drawing(s) in this data sheet may not reflect the most current specifications. For the latest package outline information, go to www.maxim-ic.com/packages.)

MAX4207

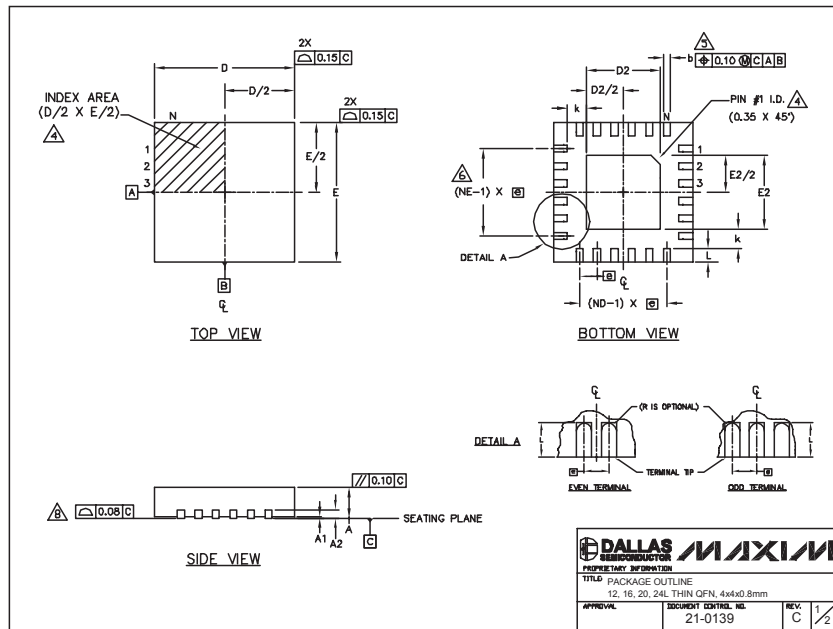

COMMON DIMENSIONS												
PKG	12L 4x4			16L 4x4			20L 4x4			24L 4x4		
REF.	MIN.	NOM.	MAX.	MIN.	NOM.	MAX.	MIN.	NOM.	MAX.	MIN.	NOM.	MAX.
A	0.70	0.75	0.80	0.70	0.75	0.80	0.70	0.75	0.80	0.70	0.75	0.80
AL	0.0	0.02	0.05	0.0	0.02	0.05	0.0	0.02	0.05	0.0	0.02	0.05
A2	0.20 REF			0.20 REF			0.20 REF			0.20 REF		
b	0.25	0.30	0.35	0.25	0.30	0.35	0.20	0.25	0.30	0.18	0.23	0.30
D	3.90	4.00	4.10	3.90	4.00	4.10	3.90	4.00	4.10	3.90	4.00	4.10
E	3.90	4.00	4.10	3.90	4.00	4.10	3.90	4.00	4.10	3.90	4.00	4.10
e	0.80 BSC.			0.65 BSC.			0.50 BSC.			0.50 BSC.		
k	0.25	-	-	0.25	-	-	0.25	-	-	0.25	-	-
L	0.45	0.55	0.65	0.45	0.55	0.65	0.45	0.55	0.65	0.30	0.40	0.50
N	12			16			20			24		
ND	3			4			5			6		
NE	3			4			5			6		
WGD	WGG8			WGGC			WGGD-1			WGGD-2		

EXPOSED PAD VARIATIONS									
PKG CODES	DE			E2			DOWN BONDS ALLOWED		
	MIN.	NOM.	MAX.	MIN.	NOM.	MAX.			
T1244-2	1.95	2.10	2.25	1.95	2.10	2.25	NO		
T1244-3	1.95	2.10	2.25	1.95	2.10	2.25	YES		
T1244-4	1.95	2.10	2.25	1.95	2.10	2.25	NO		
T1644-2	1.95	2.10	2.25	1.95	2.10	2.25	NO		
T1644-3	1.95	2.10	2.25	1.95	2.10	2.25	YES		
T1644-4	1.95	2.10	2.25	1.95	2.10	2.25	NO		
T2044-1	1.95	2.10	2.25	1.95	2.10	2.25	NO		
T2044-2	1.95	2.10	2.25	1.95	2.10	2.25	YES		
T2044-3	1.95	2.10	2.25	1.95	2.10	2.25	NO		
T2444-1	2.45	2.60	2.63	2.45	2.60	2.63	NO		
T2444-2	1.95	2.10	2.25	1.95	2.10	2.25	YES		
T2444-3	2.45	2.60	2.63	2.45	2.60	2.63	YES		
T2444-4	2.45	2.60	2.63	2.45	2.60	2.63	NO		

NOTES:

- DIMENSIONING & TOLERANCING CONFORM TO ASME Y14.5M-1994.
- ALL DIMENSIONS ARE IN MILLIMETERS. ANGLES ARE IN DEGREES.
- N IS THE TOTAL NUMBER OF TERMINALS.
- THE TERMINAL #1 IDENTIFIER AND TERMINAL NUMBERING CONVENTION SHALL CONFORM TO JEDEC 95-1 SHP-012. DETAILS OF TERMINAL #1 IDENTIFIER ARE OPTIONAL, BUT MUST BE LOCATED WITHIN THE ZONE INDICATED. THE TERMINAL #1 IDENTIFIER MAY BE EITHER A MOLD OR MARKED FEATURE.
- DIMENSION b APPLIES TO METALLIZED TERMINAL AND IS MEASURED BETWEEN 0.25 mm AND 0.30 mm FROM TERMINAL TIP.
- ND AND NE REFER TO THE NUMBER OF TERMINALS ON EACH D AND E SIDE RESPECTIVELY.
- DEPOPULATION IS POSSIBLE IN A SYMMETRICAL FASHION.
- COPLANARITY APPLIES TO THE EXPOSED HEAT SINK SLUG AS WELL AS THE TERMINALS.
- DRAWING CONFORMS TO JEDEC M220, EXCEPT FOR T2444-1, T2444-3 AND T2444-4.

Maxim cannot assume responsibility for use of any circuitry other than circuitry entirely embodied in a Maxim product. No circuit patent licenses are implied. Maxim reserves the right to change the circuitry and specifications without notice at any time.

Maxim Integrated Products, 120 San Gabriel Drive, Sunnyvale, CA 94086 408-737-7600 15