

FEATURES

Supply voltage range: 2.6 V to 5.5 V

Low power

1.2 mA + 2× excitation current

0.5 μ A shutdown current

Low input bias current: ± 100 pA

High CMRR: 120 dB

Space savings: 16-lead, 3.0 mm \times 3.0 mm \times 0.55 mm LFCSP

Excitation current

300 μ A to 1300 μ A range

Set with external resistor

APPLICATIONS

Bridge and sensor drives

Portable electronics

GENERAL DESCRIPTION

The AD8290 contains both an adjustable current source to drive a sensor and a difference amplifier to amplify the signal voltage. The amplifier is set for a fixed gain of 50. The AD8290 is an excellent solution for both the drive and the sensing aspects required for pressure, temperature, and strain gage bridges.

In addition, because the AD8290 operates with low power, works with a range of low supply voltages, and is available in a low profile package, it is suitable for drive/sense circuits in portable electronics as well.

The AD8290 is available in a lead free 3.0 mm \times 3.0 mm \times 0.55 mm package and is operational over the industrial temperature range of -40°C to $+85^{\circ}\text{C}$.

FUNCTIONAL BLOCK DIAGRAM

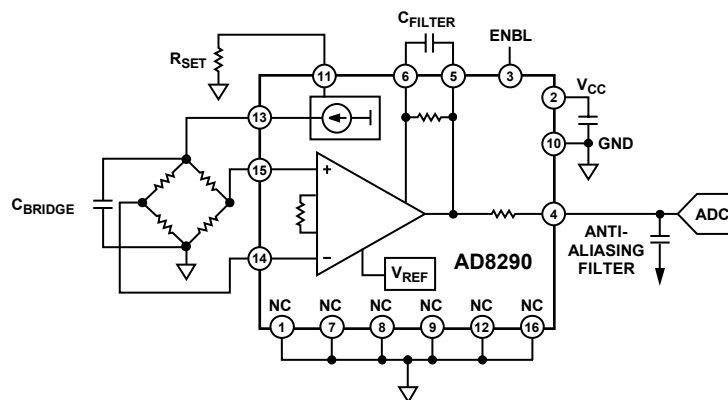

Figure 1.

06745-001

Rev. B

Information furnished by Analog Devices is believed to be accurate and reliable. However, no responsibility is assumed by Analog Devices for its use, nor for any infringements of patents or other rights of third parties that may result from its use. Specifications subject to change without notice. No license is granted by implication or otherwise under any patent or patent rights of Analog Devices. Trademarks and registered trademarks are the property of their respective owners.

One Technology Way, P.O. Box 9106, Norwood, MA 02062-9106, U.S.A.
Tel: 781.329.4700 www.analog.com
Fax: 781.461.3113 ©2007–2008 Analog Devices, Inc. All rights reserved.

TABLE OF CONTENTS

Features	1	Current Source.....	15
Applications.....	1	Applications Information	16
General Description	1	Typical Connections	16
Functional Block Diagram	1	Current Excitation.....	16
Revision History	2	Enable/Disable Function	16
Specifications.....	3	Output Filtering.....	16
Absolute Maximum Ratings.....	5	Clock Feedthrough.....	16
Thermal Resistance	5	Maximizing Performance Through Proper Layout.....	17
ESD Caution.....	5	Power Supply Bypassing	17
Pin Configuration and Function Descriptions.....	6	Dual-Supply Operation	17
Typical Performance Characteristics	7	Pressure Sensor Bridge Application.....	18
Theory of Operation	14	Temperature Sensor Application.....	19
Amplifier.....	14	ADC/Microcontroller.....	19
High Power Supply Rejection (PSR) and Common-Mode Rejection (CMR)	14	Outline Dimensions.....	20
1/f Noise Correction	14	Ordering Guide	20

REVISION HISTORY**2/08—Rev. SpA to Rev. B**

Changes to Features Section.....	1
Changes to Amplifier Section and Figure 43	14
Changes to Current Source Section	15
Changes to Current Excitation Section, Output Filtering Section, Clock Feedthrough Section, and Figure 45.....	16
Changes to Figure 46.....	17

8/07—Revision SpA**7/07—Revision 0: Initial Version**

SPECIFICATIONS

$V_{CC} = 2.6\text{ V to }5.0\text{ V}$, $T_A = 25^\circ\text{C}$, $C_{FILTER} = 6.8\text{ nF}$, output antialiasing capacitor = 68 nF , $R_{SET} = 3\text{ k}\Omega$, common-mode input = 0.6 V , unless otherwise noted.

Table 1.

Parameter	Test Conditions	Min	Typ	Max	Unit
COMMON-MODE REJECTION RATIO (CMRR)	Input voltage ($V_{INP} - V_{INN}$) range of $0.2\text{ V to }V_{CC} - 1.7\text{ V}$				
CMRR DC		110	120		dB
NOISE					
Amplifier and VREF	Input referred, $f = 0.1\text{ Hz to }10\text{ Hz}$		0.75		$\mu\text{V p-p}$
VOLTAGE OFFSET					
Output Offset	Reference is internal and set to 900 mV nominal	865	900	935	mV
Output Offset TC	$-40^\circ\text{C} < T_A < +85^\circ\text{C}$	-300	± 50	+300	$\mu\text{V}/^\circ\text{C}$
PSR			120		dB
INPUT CURRENT					
Input Bias Current		-1000	± 100	+1000	pA
Input Offset Current		-2000	± 200	+2000	pA
DYNAMIC RESPONSE					
Small Signal Bandwidth -3 dB	With external filter capacitors, $C_{FILTER} = 6.8\text{ nF}$ and output antialiasing capacitor = 68 nF		0.25		kHz
GAIN					
Gain			50		V/V
Gain Error		-1.0	± 0.5	+1.0	%
Gain Nonlinearity			± 0.0075		%
Gain Drift	$-40^\circ\text{C} < T_A < +85^\circ\text{C}$	-25	± 15	+25	ppm/ $^\circ\text{C}$
INPUT					
Differential Input Impedance			$50\ \ 1$		$\text{M}\Omega\ \ \text{pF}$
Input Voltage Range		0.2		$V_{CC} - 1.7$	V
OUTPUT					
Output Voltage Range	$V_{OUT} = \text{Gain} \times (V_{INP} - V_{INN}) + \text{Output Offset}$	0.075		$V_{CC} - 0.075$	V
Output Series Resistance			$10 \pm 20\%$		k Ω
CURRENT EXCITATION					
Excitation Current Range	Excitation current = $0.9\text{ V}/R_{SET}$	300		1300	μA
Excitation Current Accuracy		-1.0		+1.0	%
Excitation Current Drift	$-40^\circ\text{C} < T_A < +85^\circ\text{C}$	-250	± 50	+250	ppm/ $^\circ\text{C}$
External Resistor for Setting Excitation Current (R_{SET})		692		3000	Ω
Excitation Current Power Supply Rejection		-2.0	+0.2	+2.0	$\mu\text{A}/\text{V}$
Excitation Current Pin Voltage		0		$V_{CC} - 1.0$	V
Excitation Current Output Resistance			100		$\text{M}\Omega$
Required Capacitor from Ground to Excitation Current Pin (C_{BRIDGE})			0.1		μF
ENABLE					
ENBL High Level	$V_{CC} < 2.9\text{ V}$ $V_{CC} > 2.9\text{ V}$	$V_{CC} - 0.5$		V_{CC}	V
ENBL Low Level		2.4		V_{CC}	V
Start-Up Time for ENBL		GND	5.0	0.8	V ms

AD8290

Parameter	Test Conditions	Min	Typ	Max	Unit
POWER SUPPLY					
Operating Range		2.6		5.5	V
Quiescent Current			1.2 + 2× excitation current	1.8 + 2× excitation current	mA
Shutdown Current			0.5	10	μA
TEMPERATURE RANGE					
For Operational Performance		-40		+85	°C

ABSOLUTE MAXIMUM RATINGS

Table 2.

Parameter	Rating
Supply Voltage	6 V
Input Voltage	+V _{SUPPLY}
Differential Input Voltage ¹	±V _{SUPPLY}
Output Short-Circuit Duration to GND	Indefinite
Storage Temperature Range	−65°C to +150°C
Operating Temperature Range	−40°C to +85°C
Junction Temperature Range	−65°C to +150°C
Lead Temperature (Soldering, 10 sec)	300°C

¹ Differential input voltage is limited to ±5.0 V, the supply voltage, or whichever is less.

Stresses above those listed under Absolute Maximum Ratings may cause permanent damage to the device. This is a stress rating only; functional operation of the device at these or any other conditions above those indicated in the operational section of this specification is not implied. Exposure to absolute maximum rating conditions for extended periods may affect device reliability.

THERMAL RESISTANCE

θ_{JA} is specified for the worst-case conditions, that is, a device soldered in a circuit board for surface-mount packages.

Table 3.

Package Type	θ_{JA}	θ_{JC}	Unit
16-Lead LFCSP (0.55 mm)	42.5	7.7	°C/W

ESD CAUTION



ESD (electrostatic discharge) sensitive device. Charged devices and circuit boards can discharge without detection. Although this product features patented or proprietary protection circuitry, damage may occur on devices subjected to high energy ESD. Therefore, proper ESD precautions should be taken to avoid performance degradation or loss of functionality.

PIN CONFIGURATION AND FUNCTION DESCRIPTIONS

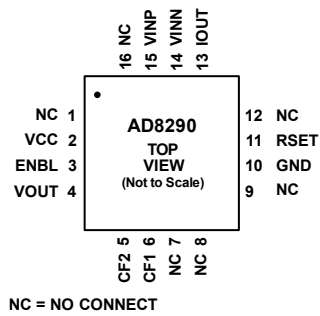

Figure 2. Pin Configuration

Table 4. Pin Function Descriptions

Pin No.	Mnemonic	Description
1	NC	Tie to Ground ¹ or Pin 16.
2	VCC	Positive Power Supply Voltage.
3	ENBL	Logic 1 enables the part, and Logic 0 disables the part.
4	VOUT	Open End of Internal 10 kΩ Resistor. Tie one end of external antialiasing filter capacitor (6.8 nF) to this pin, and tie the other end to ground. ¹
5	CF2	Tie one end of the C _{FILTER} (68 nF) that is in parallel with the internal gain resistor to this pin.
6	CF1	Tie the other end of the C _{FILTER} (68 nF) that is in parallel with the internal gain resistor to this pin.
7	NC	Tie to Ground. ¹
8	NC	Tie to Ground. ¹
9	NC	Tie to Ground. ¹
10	GND	Ground ¹ or Negative Power Supply Voltage.
11	RSET	Tie one end of Resistor R _{SET} to this pin to set the excitation current and tie the other end of Resistor R _{SET} to Pin 10.
12	NC	Tie to Ground. ¹
13	IOOUT	Excitation Current Output. Tie one end of C _{BRIDGE} (0.1 μF) to this pin and tie the other end of C _{BRIDGE} to ground. ¹
14	VINN	Negative Input Terminal.
15	VINP	Positive Input Terminal.
16	NC	Tie to Ground ¹ or Pin 1.
17/Pad	NC	Pad should be floating and not tied to any potential.

¹ During dual-supply operation, ground becomes the negative power supply voltage.

TYPICAL PERFORMANCE CHARACTERISTICS

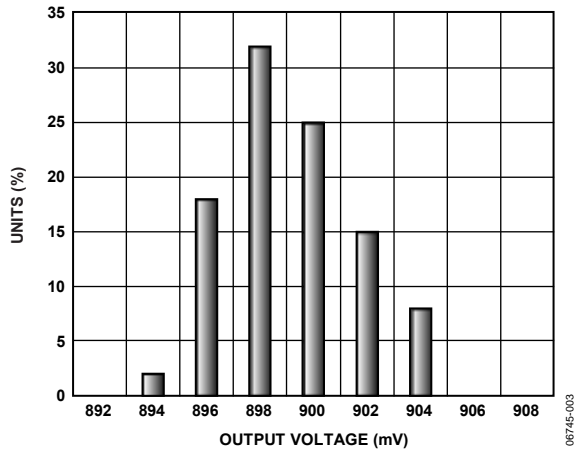

Figure 3. Output Offset Voltage at 2.6 V Supply

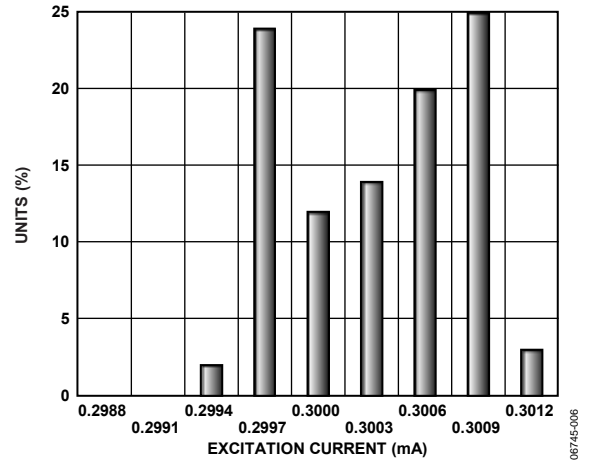

Figure 6. Excitation Output Current for 3 kΩ RSET at 2.6 V Supply

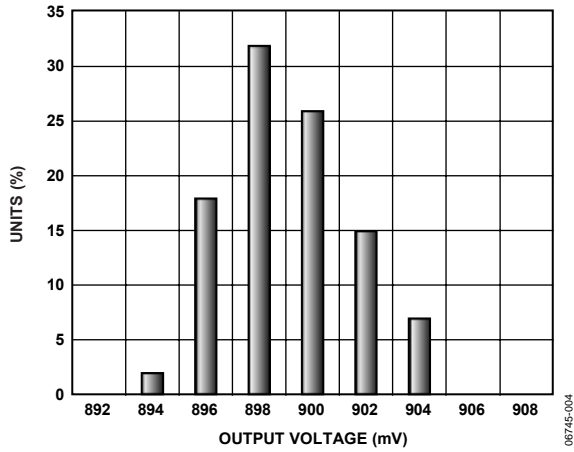

Figure 4. Output Offset Voltage at 3.6 V Supply

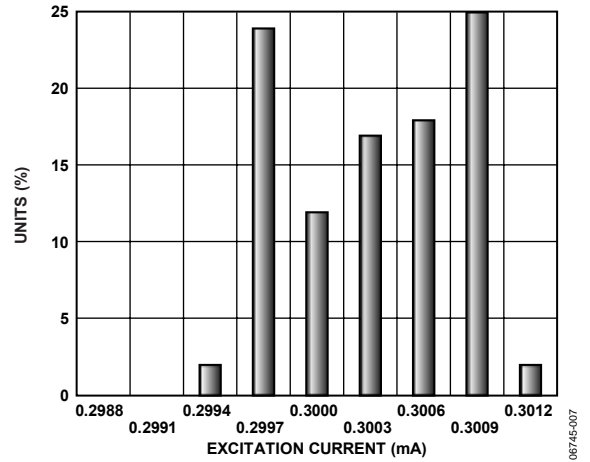

Figure 7. Excitation Output Current for 3 kΩ RSET at 3.6 V Supply

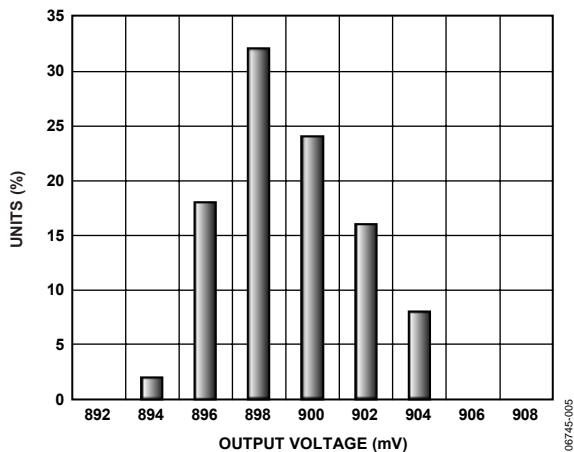

Figure 5. Output Offset Voltage at 5.0 V Supply

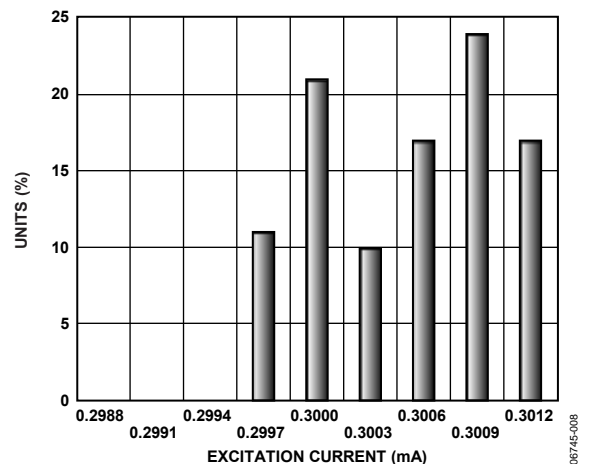

Figure 8. Excitation Output Current for 3 kΩ RSET at 5.0 V Supply

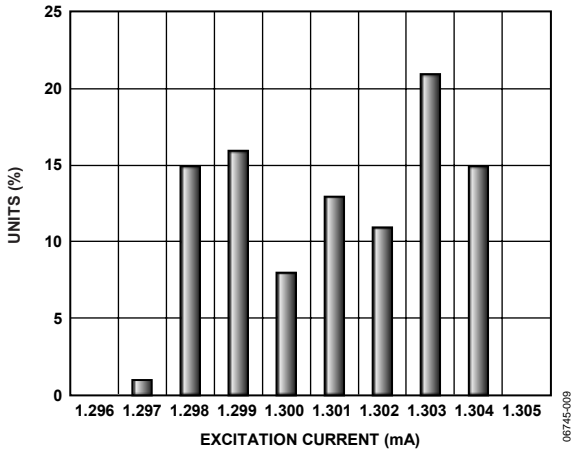

Figure 9. Output Excitation Current for 692 Ω R_{SET} at 2.6 V Supply

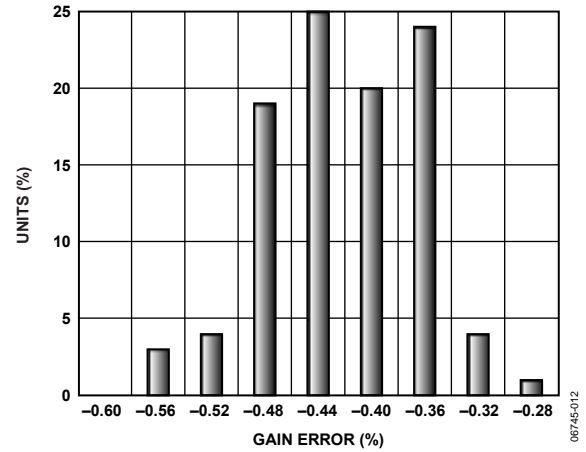

Figure 12. Percent Gain Error at 2.6 V Supply

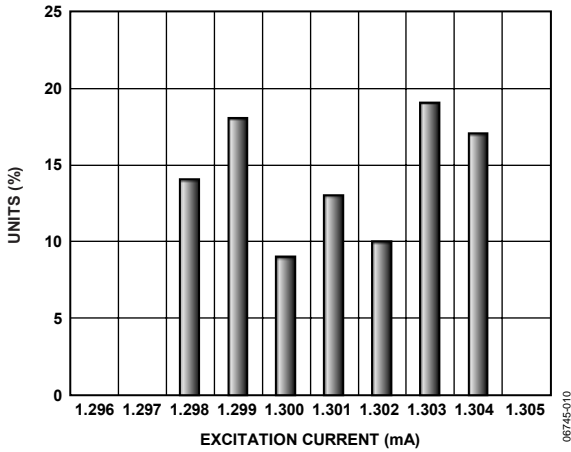

Figure 10. Output Excitation Current for 692 Ω R_{SET} at 3.6 V Supply

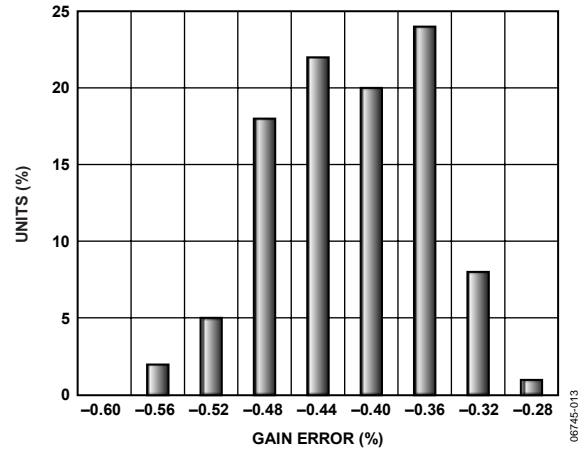

Figure 13. Percent Gain Error at 3.6 V Supply

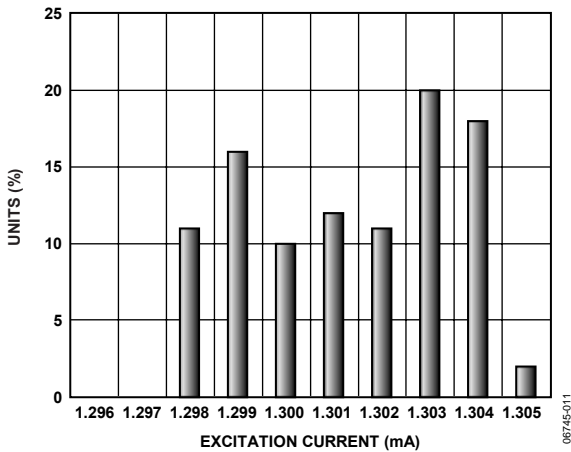

Figure 11. Output Excitation Current for 692 Ω R_{SET} at 5.0 V Supply

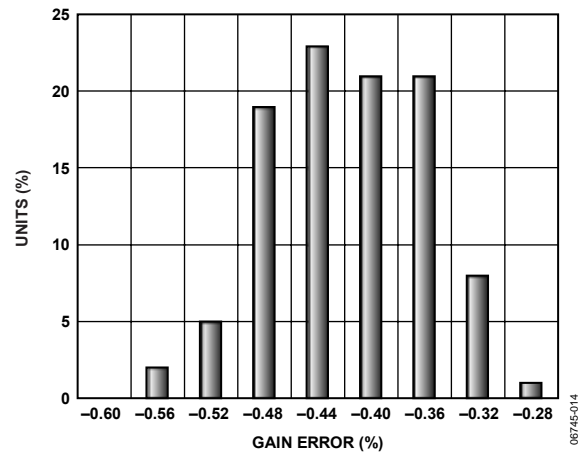

Figure 14. Percent Gain Error at 5.0 V Supply

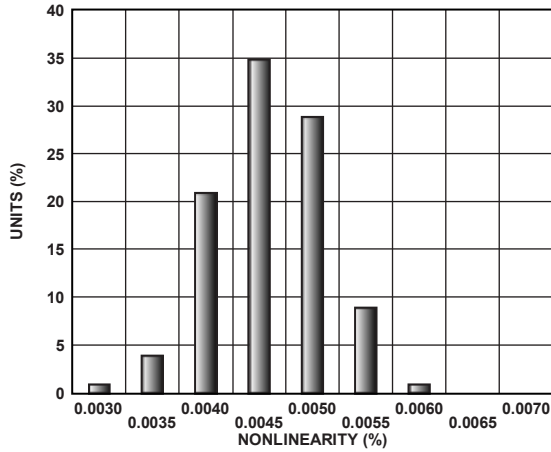

Figure 15. Percent Nonlinearity at 2.6 V Supply

06745-026

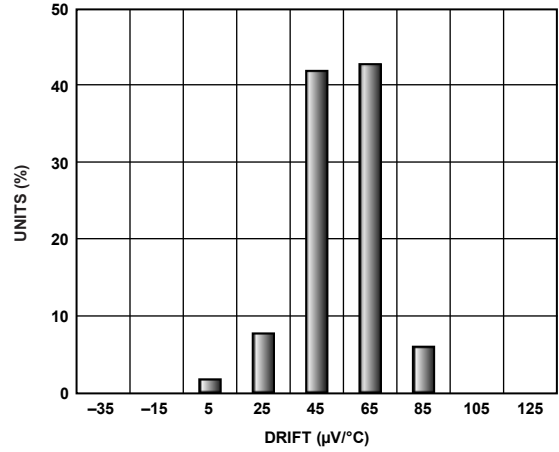

Figure 18. Output Offset Voltage Drift from -40°C to +85°C at 2.6 V Supply

06745-031

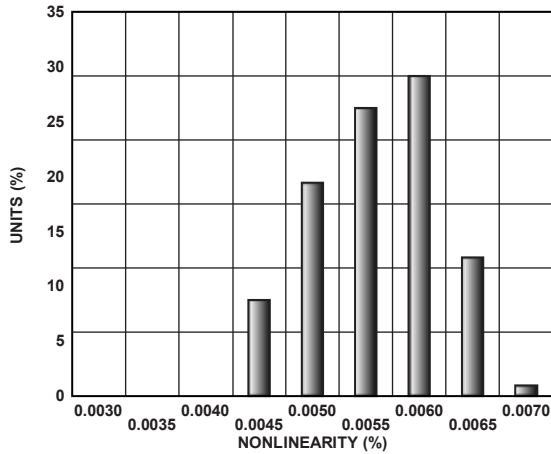

Figure 16. Percent Nonlinearity at 3.6 V Supply

06745-027

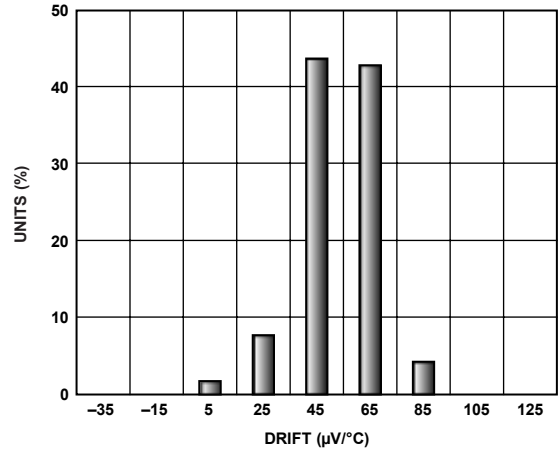

Figure 19. Output Offset Voltage Drift from -40°C to +85°C at 3.6 V Supply

06745-032

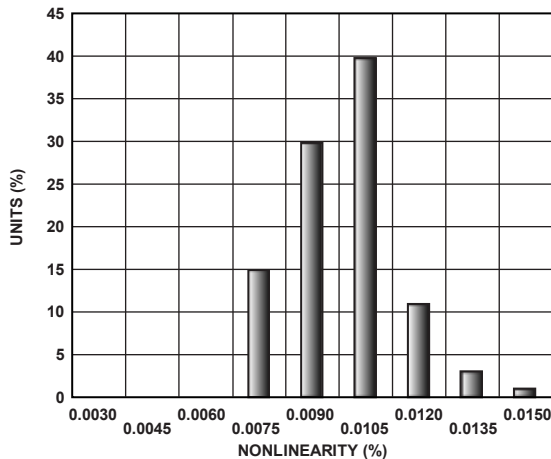

Figure 17. Percent Nonlinearity at 5.0 V Supply

06745-028

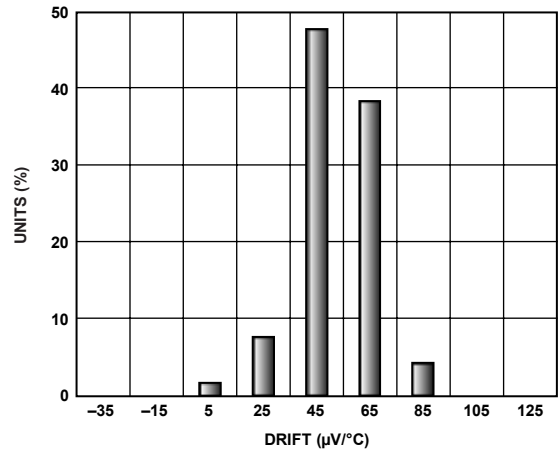

Figure 20. Output Offset Voltage Drift from -40°C to +85°C at 5.0 V Supply

06745-033

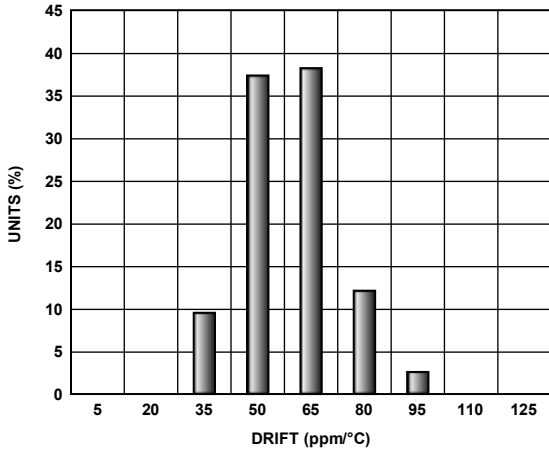

Figure 21. Excitation Current Drift from -40°C to $+85^{\circ}\text{C}$ at 2.6 V Supply, $R_{\text{SET}} = 3 \text{ k}\Omega$

06745-035

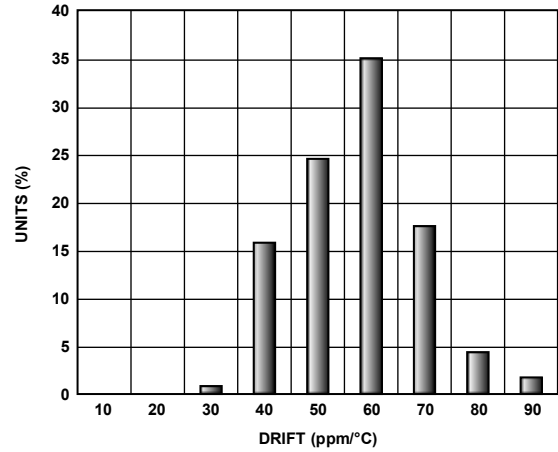

Figure 24. Excitation Current Drift from -40°C to $+85^{\circ}\text{C}$ at 2.6 V Supply, $R_{\text{SET}} = 692 \Omega$

06745-039

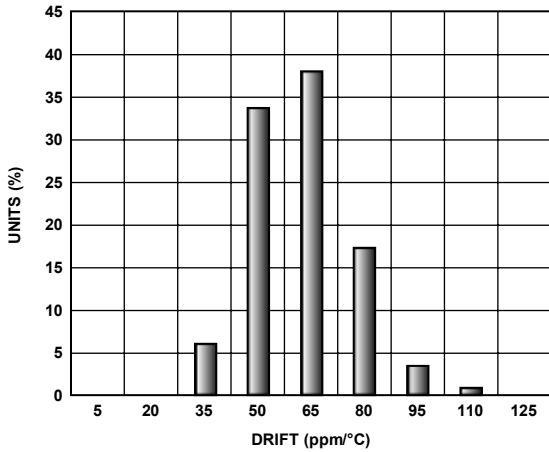

Figure 22. Excitation Current Drift from -40°C to $+85^{\circ}\text{C}$ at 3.6 V Supply, $R_{\text{SET}} = 3 \text{ k}\Omega$

06745-036

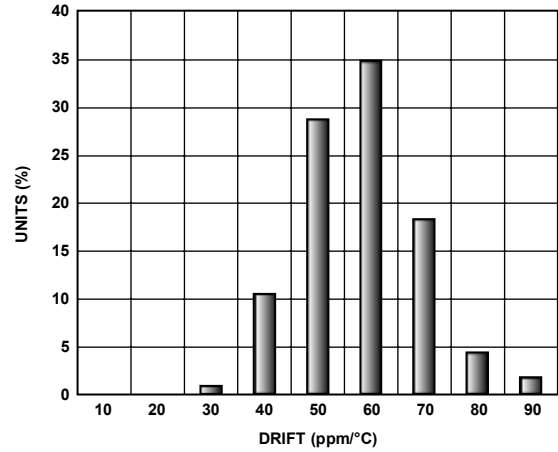

Figure 25. Excitation Current Drift from -40°C to $+85^{\circ}\text{C}$ at 3.6 V Supply, $R_{\text{SET}} = 692 \Omega$

06745-040

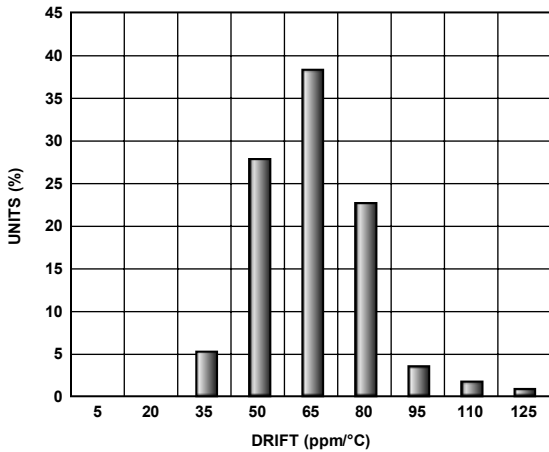

Figure 23. Excitation Current Drift from -40°C to $+85^{\circ}\text{C}$ at 5.0 V Supply, $R_{\text{SET}} = 3 \text{ k}\Omega$

06745-037

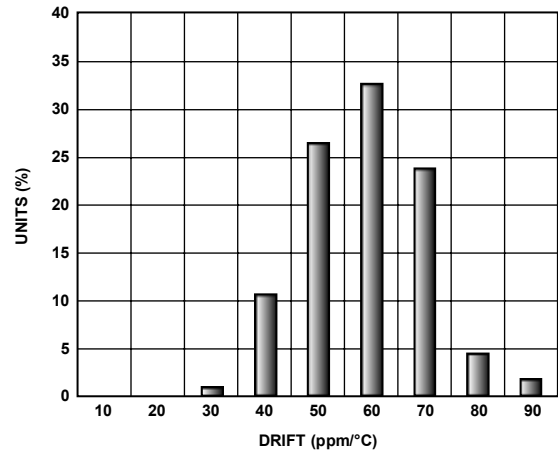

Figure 26. Excitation Current Drift from -40°C to $+85^{\circ}\text{C}$ at 5.0 V Supply, $R_{\text{SET}} = 692 \Omega$

06745-041

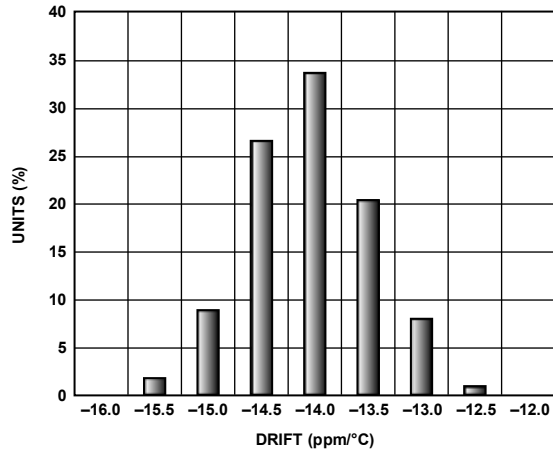

Figure 27. Gain Drift from -40°C to $+85^{\circ}\text{C}$ at 2.6 V Supply

06745-045

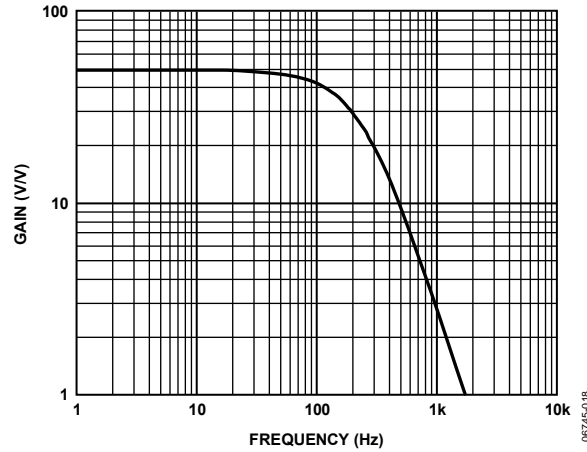

Figure 30. Frequency Response for Supply Range of 2.6 V to 5.0 V (External $C_{\text{FILTER}} = 6.8 \text{ nF}$, Antialiasing Capacitor = 68 nF)

06745-018

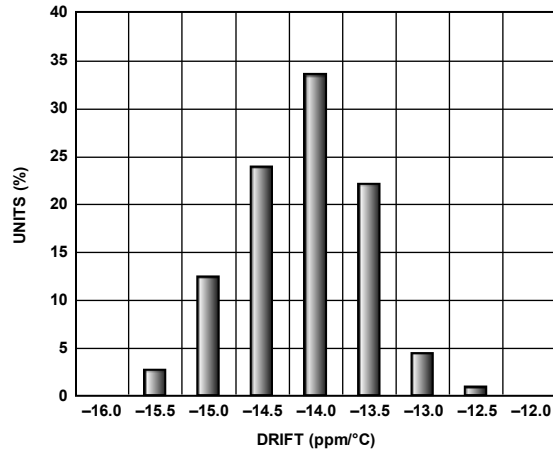

Figure 28. Gain Drift from -40°C to $+85^{\circ}\text{C}$ at 3.6 V Supply

06745-046

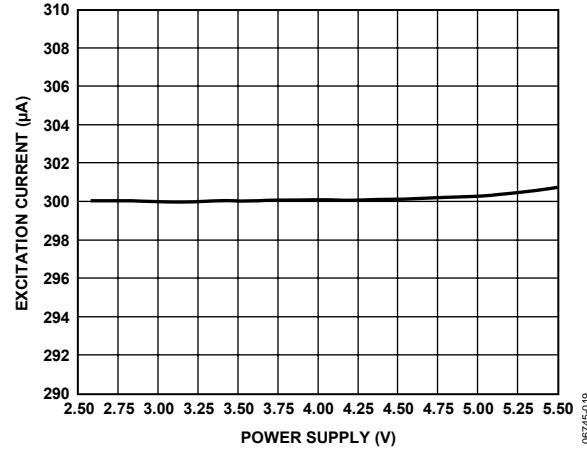

Figure 31. Low Excitation Current vs. Power Supply

06745-019

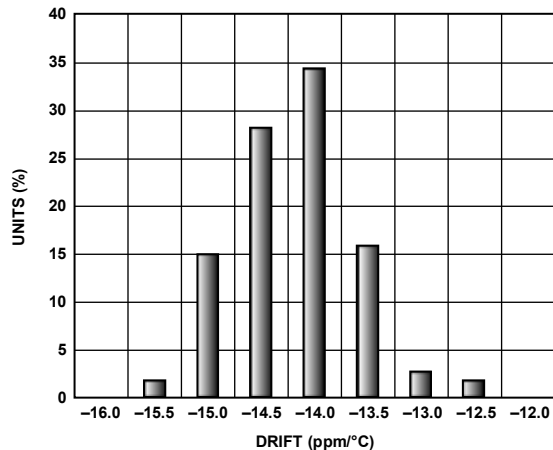

Figure 29. Gain Drift from -40°C to $+85^{\circ}\text{C}$ at 5.0 V Supply

06745-047

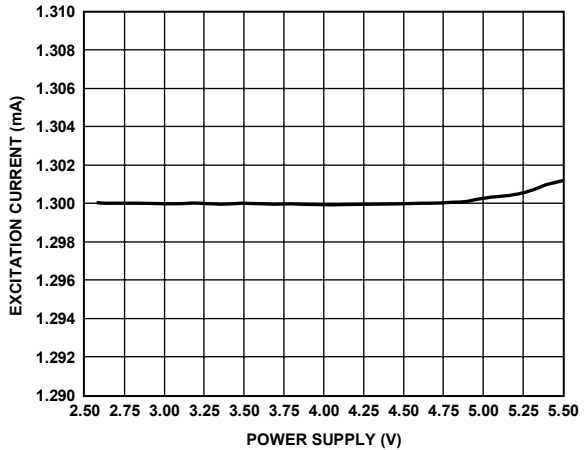

Figure 32. High Excitation Current vs. Power Supply

06745-020

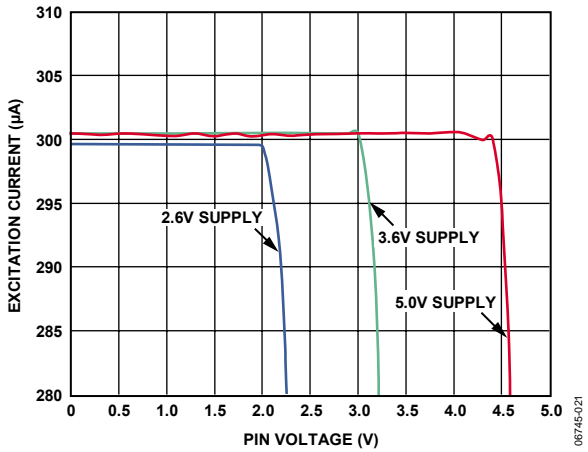

Figure 33. Low Excitation Current vs. Excitation Current Pin Voltage

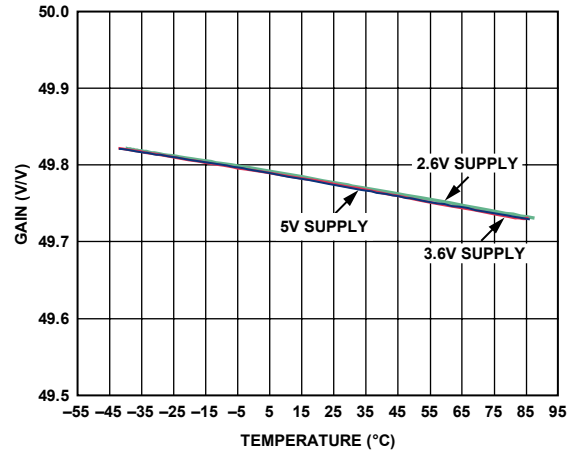

Figure 36. Gain vs. Temperature

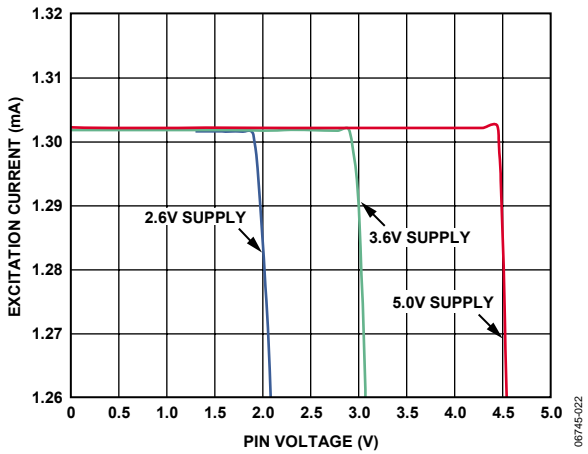

Figure 34. High Excitation Current vs. Excitation Current Pin Voltage

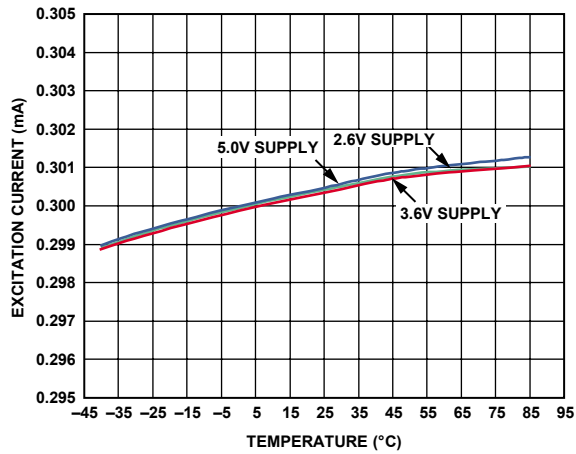

Figure 37. Excitation Current vs. Temperature, $R_{SET} = 3\text{ k}\Omega$

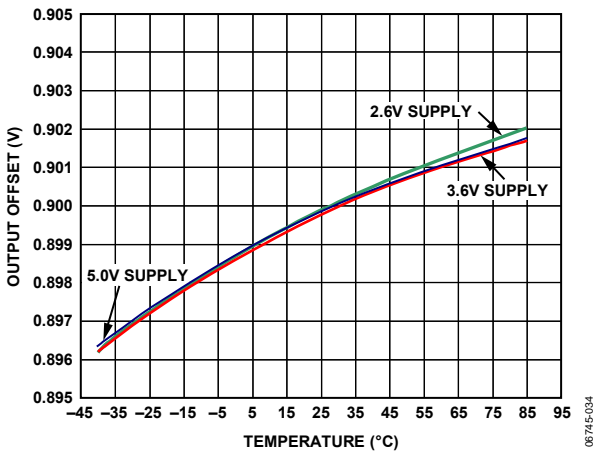

Figure 35. Output Offset Voltage vs. Temperature

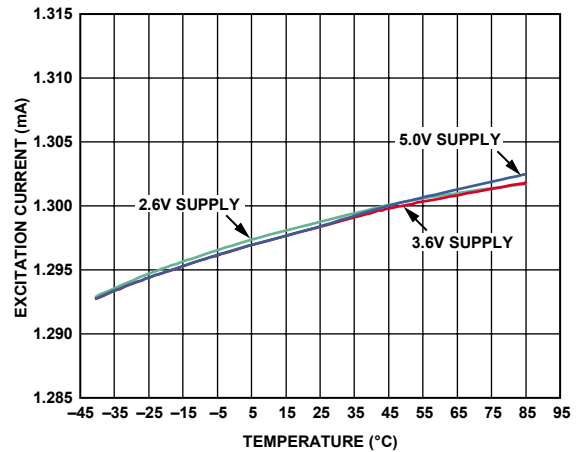

Figure 38. Excitation Current vs. Temperature, $R_{SET} = 692\ \Omega$

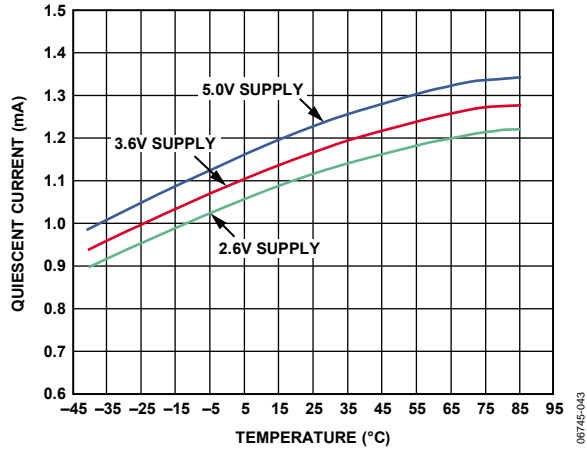

Figure 39. Quiescent Current vs. Temperature (Excludes 2x Excitation Current)

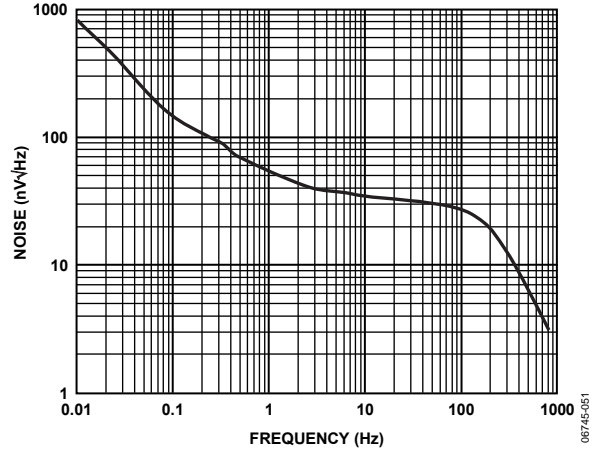

Figure 41. Input-Referred Noise vs. Frequency

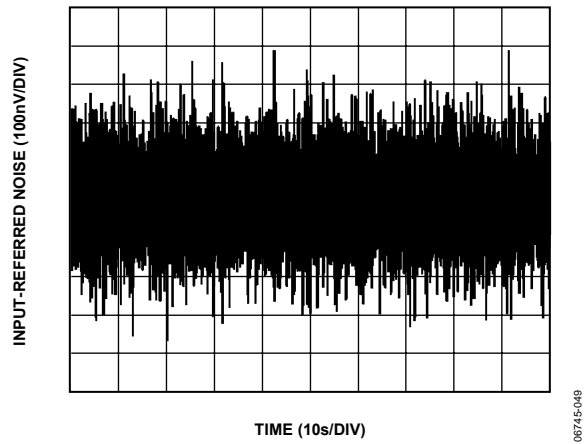

Figure 40. 0.01 Hz to 10 Hz Input-Referred Noise

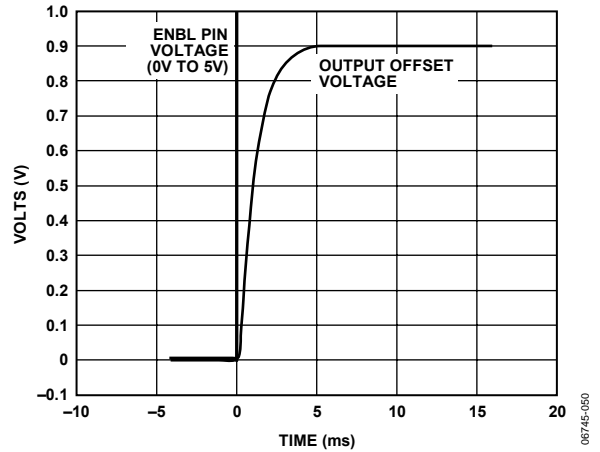

Figure 42. ENBL Pin Voltage for 5.0 V Supply vs. Output Offset Voltage Start-Up Time

THEORY OF OPERATION

AMPLIFIER

The amplifier of the AD8290 is a precision current-mode correction instrumentation amplifier. It is internally set to a fixed gain of 50. The current-mode correction topology results in excellent accuracy.

Figure 43 shows a simplified diagram illustrating the basic operation of the instrumentation amplifier within the AD8290 (without correction). The circuit consists of a voltage-to-current amplifier (M1 to M6), followed by a current-to-voltage amplifier (R2 and A1). Application of a differential input voltage forces a current through R1, resulting in a conversion of the input voltage to a signal current. Transistors M3 to M6 transfer twice the signal current to the inverting input of the op amp, A1. A1 and R2 form a current-to-voltage converter to produce a rail-to-rail output voltage, V_{OUT} .

Op Amp A1 is a high precision auto-zero amplifier. This amplifier preserves the performance of the autocorrecting, current-mode amplifier topology while offering the user a true voltage-in, voltage-out instrumentation amplifier. Offset errors are corrected internally.

An internal 0.9 V reference voltage is applied to the noninverting input of A1 to set the output offset level. External Capacitor C_{FILTER} is used to filter out correction noise.

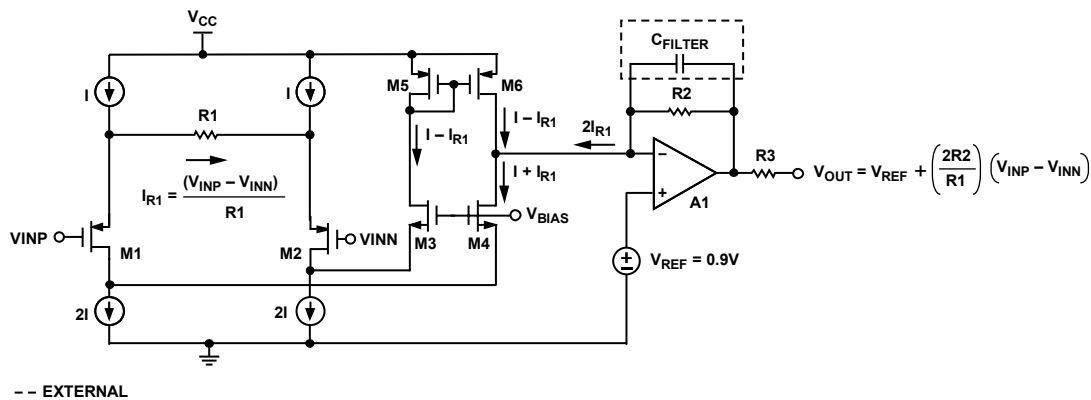

Figure 43. Simplified Schematic of the Instrumentation Amplifier Within the AD8290

HIGH POWER SUPPLY REJECTION (PSR) AND COMMON-MODE REJECTION (CMR)

PSR and CMR indicate the amount that the offset voltage of an amplifier changes when its common-mode input voltage or power supply voltage changes. The autocorrection architecture of the AD8290 continuously corrects for offset errors, including those induced by changes in input or supply voltage, resulting in exceptional rejection performance. The continuous autocorrection provides great CMR and PSR performances over the entire operating temperature range (-40°C to $+85^{\circ}\text{C}$).

1/f NOISE CORRECTION

Flicker noise, also known as 1/f noise, is noise inherent in the physics of semiconductor devices and decreases 10 dB per decade. The 1/f corner frequency of an amplifier is the frequency at which the flicker noise is equal to the broadband noise of the amplifier. At lower frequencies, flicker noise dominates causing large errors in low frequency or dc applications.

Flicker noise appears as a slowly varying offset error that is reduced by the autocorrection topology of the AD8290, allowing the AD8290 to have lower noise near dc than standard low noise instrumentation amplifiers.

CURRENT SOURCE

The AD8290 generates an excitation current that is programmable with an external resistor, R_{SET} , as shown in Figure 44. A1 and M1 are configured to produce 0.9 V across R_{SET} , which is based on an internal 0.9 V reference and creates a current equal to $0.9 \text{ V}/R_{SET}$ internal to the AD8290. This current is passed to a precision current mirror and a replica of the current is sourced from the IOOUT pin. This current can be used for the excitation of a sensor bridge. C_{BRIDGE} is used to filter noise from the current excitation circuit.

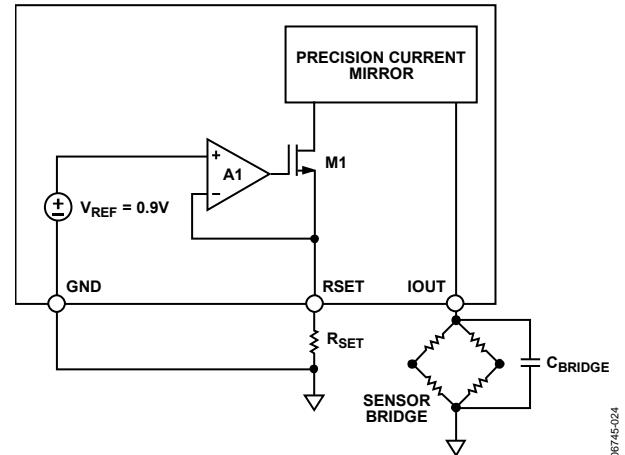

Figure 44. Current Excitation

06745-024

APPLICATIONS INFORMATION

TYPICAL CONNECTIONS

Figure 45 shows the typical connections for single-supply operation when used with a sensor bridge.

CURRENT EXCITATION

In Figure 45, R_{SET} is used to set the excitation current sourced at the IOUT pin. The formula for the excitation current I_{OUT} is

$$I_{OUT} = (900/R_{SET}) \text{ mA}$$

where R_{SET} is the resistor between Pin 10 (GND) and Pin 11 (RSET).

The AD8290 is internally set by the factory to provide the current excitation described by the previous formula (within the tolerance range listed in Table 1). The range of R_{SET} is 692 Ω to 3 k Ω , resulting in a corresponding I_{OUT} of 1300 μA to 300 μA , respectively.

ENABLE/DISABLE FUNCTION

Pin 3 (ENBL) provides the enabling/disabling function of the AD8290 to conserve power when the device is not needed. A Logic 1 turns the part on and allows it to operate normally. A Logic 0 disables the output and excitation current and reduces the quiescent current to less than 10 μA .

The turn-on time upon switching Pin 3 high is dominated by the output filters. When the device is disabled, the output becomes high impedance, enabling the muxing application of multiple AD8290 instrumentation amplifiers.

OUTPUT FILTERING

Filter Capacitor C_{FILTER} is required to limit the amount of switching noise present at the output. The recommended bandwidth of the filter created by C_{FILTER} and an internal 100 k Ω is 235 Hz. Select C_{FILTER} based on

$$C_{FILTER} = 1/(235 \times 2 \times \pi \times 100 \text{ k}\Omega) = 6.8 \text{ nF}$$

For bandwidths greater than 10 Hz, an additional single-pole RC filter of 235 Hz is required on the output, which is also recommended when driving an ADC requiring an antialiasing filter. Internal to the AD8290 is a series 10 k Ω resistor at the output (R3 in Figure 43) and using an external 68 nF capacitor to ground produces an RC filter of 235 Hz on the output as well. These two filters produce an overall bandwidth of approximately 160 Hz for the output signal.

In addition, when driving low impedances, the internal series 10 k Ω resistor creates a voltage divider at the output. If it is necessary to access the output of the internal amplifier prior to the 10 k Ω resistor, it is available at the CF2 pin.

For applications with low bandwidths (<10 Hz), only the first filter capacitor (C_{FILTER}) is required. In this case, the high frequency noise from the auto-zero amplifier (output amplifier) is not filtered before the following stage.

CLOCK FEEDTHROUGH

The AD8290 uses two synchronized clocks to perform autocorrection. The input voltage-to-current amplifiers are corrected at 60 kHz.

Trace amounts of these clock frequencies can be observed at the output. The amount of feedthrough is dependent upon the gain because the autocorrection noise has an input- and output-referred term. The correction feedthrough is also dependent upon the values of the external capacitors, C2 and C_{FILTER} .

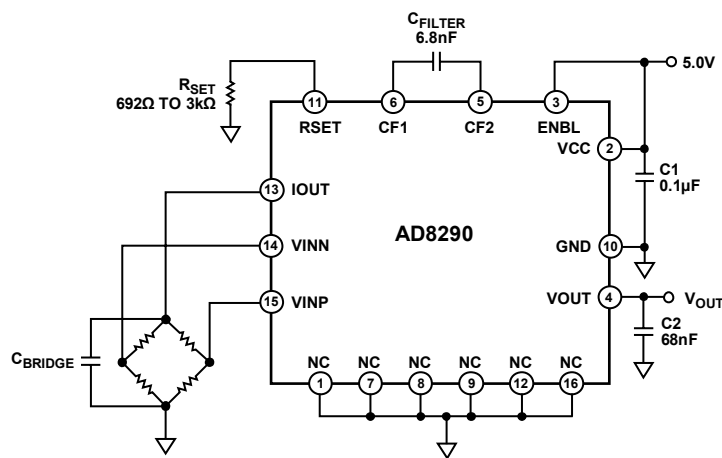

NC = NO CONNECT

NOTES

LAYOUT CONSIDERATIONS:

1. KEEP C1 CLOSE TO PIN 2 AND PIN 10.
2. KEEP R_{SET} CLOSE TO PIN 11.

Figure 45. Typical Single-Supply Connections
Rev. B | Page 16 of 20

06745-025

MAXIMIZING PERFORMANCE THROUGH PROPER LAYOUT

To achieve the maximum performance of the AD8290, care should be taken in the circuit board layout. The PCB surface must remain clean and free of moisture to avoid leakage currents between adjacent traces. Surface coating of the circuit board reduces surface moisture and provides a humidity barrier, reducing parasitic resistance on the board.

R_{SET} should be placed close to RSET (Pin 11) and GND (Pin 10). The paddle on the bottom of the package should not be connected to any potential and should be floating.

For high impedance sources, the PCB traces from the AD8290 inputs should be kept to a minimum to reduce input bias current errors.

POWER SUPPLY BYPASSING

The AD8290 uses internally generated clock signals to perform autocorrection. As a result, proper bypassing is necessary to achieve optimum performance. Inadequate or improper bypassing of the supply lines can lead to excessive noise and offset voltage. A 0.1 μF surface-mount capacitor should be connected between Pin 2 (VCC) and Pin 10 (GND) when operating with a single supply and should be located as close as possible to those two pins.

DUAL-SUPPLY OPERATION

The AD8290 can be configured to operate in dual-supply mode. An example of such a circuit is shown in Figure 46, where the AD8290 is powered by $\pm 1.8\text{ V}$ supplies. When operating with dual supplies, pins that are normally referenced to ground in the single-supply mode, now need to be referenced to the negative supply. These pins include the following: Pin 1, Pin 7, Pin 8, Pin 9, Pin 10, Pin 12, and Pin 16. External components, such as R_{SET} , the sensing bridge, and the antialiasing filter capacitor at the output, should also be referenced to the negative supply. Additionally, two bypass capacitors should be added beyond what is necessary for single-supply operation: one between the negative supply and ground, and the other between the positive and negative supplies.

When operating in dual-supply mode, the specifications change and become relative to the negative supply. The input voltage range minimum shifts from 0.2 V to 0.2 V above the negative supply (in this example: -1.6 V), the output voltage range shifts from a minimum of 0.075 V to 0.075 V above the negative supply (in this example: -1.725 V), and the excitation current pin voltage minimum shifts from 0 V to -1.8 V in this example. The maximum specifications of these three parameters are specified relative to V_{CC} in Table 1 and do not change.

For other specifications, both the minimum and maximum specifications change. The output offset shifts from a minimum of $+865\text{ mV}$ and maximum of $+935\text{ mV}$ to a minimum of -935 mV and a maximum of -865 mV in the example. In addition, the logic levels for the ENBL operation should be adjusted accordingly.

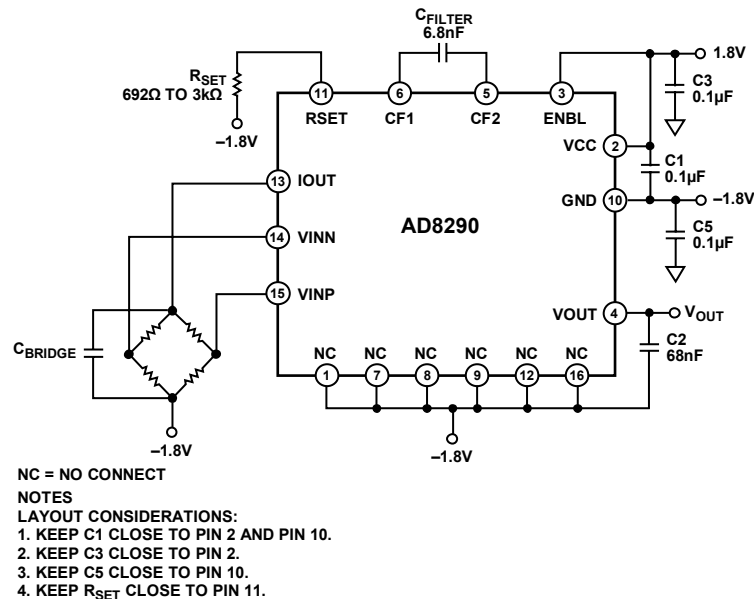

Figure 46. Typical Dual-Supply Connections

TEMPERATURE SENSOR APPLICATION

The AD8290 can be used with a temperature sensor. Figure 48 shows the AD8290 in conjunction with an RTD, in this example, a 2-wire PT100. The specifications for the sensor are shown in Table 8 and the chosen conditions for the AD8290 are listed in Table 9.

Once again, care must be taken when picking the excitation current and R_G such that the minimum and maximum specifications of the AD8290 are not exceeded. Sample calculations are shown in Table 10.

ADC/MICROCONTROLLER

In both of the previous applications, an ADC or a microcontroller can be used to follow the AD8290 to convert the output analog signal to digital. For example, if there are multiple sensors in the system, the six channel ADuC814ARU microcontroller is an excellent candidate to interface with multiple AD8290s.

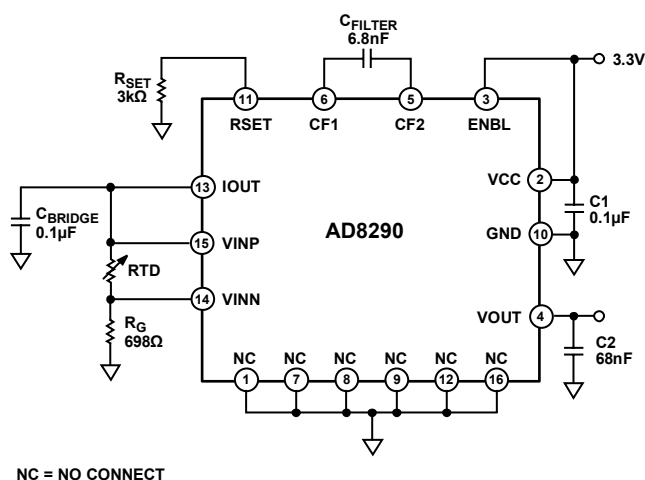

Figure 48. PT100 Temperature Sensor Application Connections

Table 8. PT100 Specifications

RTD Minimum @ 0°C	RTD Maximum @ 100°C
100 Ω	138.5 Ω

Table 9. Typical AD8290 Conditions for Temperature Sensor Circuit

AD8290 V _{CC} (V)	Excitation Current (μA)	Resistor from RTD to GND, R _G (Ω)
3.30 (2.6 to 5.5)	300 (300 to 1300)	698

Table 10. Temperature Sensor Circuit Calculations Compared to AD8290 Minimum/Maximum Specifications

Specification	Calculation	Unit	Allowable Range of AD8290
Supply Current	1.8	mA	
Current Setting Resistor (R _{SET})	3000	Ω	692 Ω to 3000 Ω
Minimum Equivalent Resistance to IOUT Pin	798	Ω	
Maximum Equivalent Resistance to IOUT Pin	836.5	Ω	
Minimum Voltage @ Current Output Pin (IOUT)	0.239	V	>0.0 V
Maximum Voltage @ Current Output Pin (IOUT)	0.251	V	<2.3 V
Input Voltage Minimum	0.209	V	>0.2 V
Input Voltage Maximum	0.251	V	<1.6 V
Output Voltage Minimum	2.365	V	>0.075 V
Output Voltage Maximum	3.013	V	<3.225 V

OUTLINE DIMENSIONS

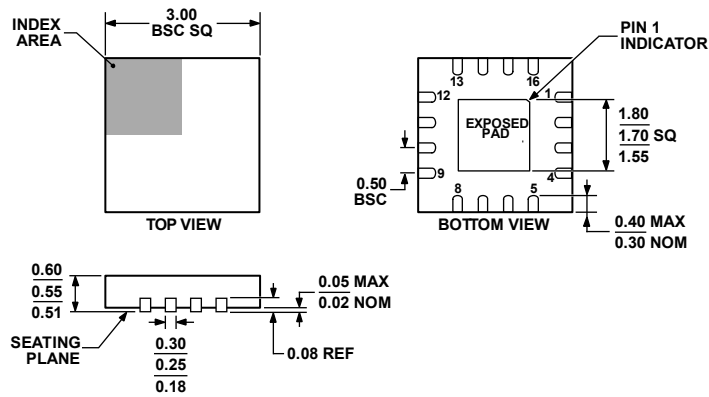

COMPLIANT TO JEDEC STANDARDS MO-248-UEED.

Figure 49. 16-Lead Lead Frame Chip Scale Package [LFCSP_UQ]
 3 mm × 3 mm Body, Ultra Thin Quad
 (CP-16-12)
 Dimensions shown in millimeters

053106-B

ORDERING GUIDE

Model	Temperature Range	Package Description	Package Option	Branding
AD8290ACPZ-R2 ¹	-40°C to +85°C	16-Lead LFCSP_UQ	CP-16-12	Y0J
AD8290ACPZ-R7 ¹	-40°C to +85°C	16-Lead LFCSP_UQ	CP-16-12	Y0J
AD8290ACPZ-RL ¹	-40°C to +85°C	16-Lead LFCSP_UQ	CP-16-12	Y0J

¹ Z = RoHS Compliant Part.