

## ULTRA WIDE BAND, HIGH SLEW RATE QUAD OPERATIONAL AMPLIFIER

### ■ GENERAL DESCRIPTION

The NJM2138 is an ultra wide band, high slew rate quad operational amplifier operated from low voltage ( $\pm 1.35V$ ).

It can apply to active filter, high-speed analog and digital signal processor, line driver, HDTV, industrial measurement equipment and others.

It can also apply to portable communication items because of low operating voltage and low operating current.

### ■ PACKAGE OUTLINE

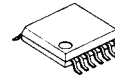

NJM2138V

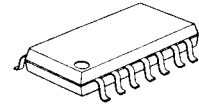

NJM2138M

### ■ FEATURES

- Operating Voltage ( $\pm 1.35V \sim \pm 6V$ )
- Ultra Wide Band (200MHz typ.)
- High Slew Rate ( $45V/\mu s$  typ.)
- Low Operating Current (2.27mA typ.)
- Bipolar Technology
- Package Outline SSOP14, DMP14

### ■ PIN CONFIGURATION

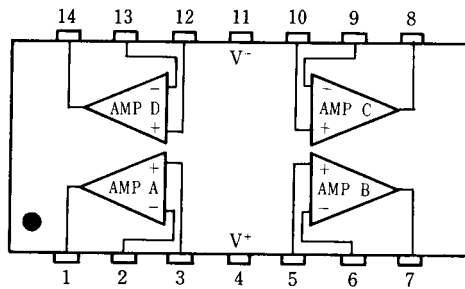

NJM2138M  
NJM2138V

### PIN FUNCTION

- |                  |                   |
|------------------|-------------------|
| 1.A OUTPUT       | 8.C OUTPUT        |
| 2.A -INPUT       | 9.C -INPUT        |
| 3.A +INPUT       | 10.C +INPUT       |
| 4.V <sup>+</sup> | 11.V <sup>-</sup> |
| 5.B +INPUT       | 12.D +INPUT       |
| 6.B -INPUT       | 13.D -INPUT       |
| 7.B OUTPUT       | 14.D OUTPUT       |

### ■ EQUIVALENT CIRCUIT (1/4 Shown)

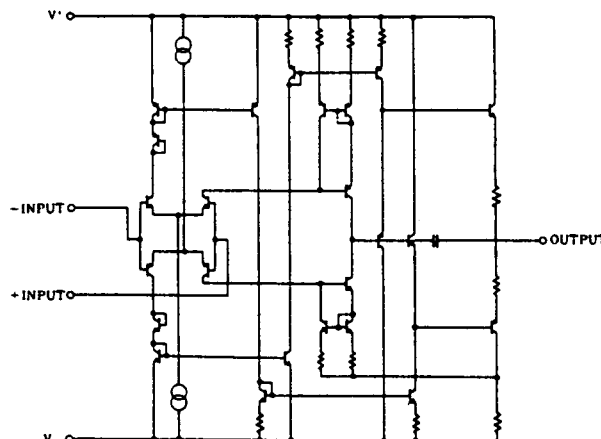

# NJM2138

## ■ ABSOLUTE MAXIMUM RATINGS

( Ta=25°C )

PARAMETER	SYMBOL	RATINGS	UNIT
Supply Voltage	$V^+V^-$	$\pm 6.75$	V
Differential Input Voltage	$V_{ID}$	$\pm 3$	V
Power Dissipation	$P_D$	( SSOP14 ) 300 ( DMP14 ) 300	mW
Operating Temperature Range	$T_{opr}$	-40~+85	°C
Storage Temperature Range	$T_{stg}$	-50~+125	°C

## ■ ELECTRICAL CHARACTERISTICS

(  $V^+V^- = \pm 2.5V, Ta = 25^\circ C$  )

PARAMETER	SYMBOL	TEST CONDITION	MIN.	TYP.	MAX.	UNIT
Operating Voltage	$V^+V^-$		$\pm 1.35$	$\pm 2.50$	$\pm 6.00$	V
Input Offset Voltage	$V_{IO}$	$R_S = 0\Omega$	-	1.0	5.0	mV
Input Bias Current	$I_B$		-	0.5	2.0	$\mu A$
Input Offset Current	$I_{IO}$		-	20	200	nA
Large Signal Voltage Gain	$A_V$	$R_L \geq 10k\Omega$	65	75	-	dB
Input Common Mode Voltage Range	$V_{ICM}$		1.2 -1.2	1.5 -1.5	-	V
Common Mode Rejection Ratio	CMR	$-1V \leq V_{cm} \leq +1V$	45	60	-	dB
Supply Voltage Rejection Ratio	+SVR		50	60	-	dB
	-SVR		70	80	-	dB
Maximum Output Voltage Swing	$V_{OM}$	$R_L = 1k\Omega$	1.1 -0.9	1.4 -1.2	-	V
Operating Current	$I_{CC}$	$R_L = \infty$ ( all Amp. )	-	2.27	3.0	mA
Slew Rate	SR	$A_V = 0dB$	-	45	-	V/ $\mu s$
Gain Bandwidth Product	GB	60dB • 500kHz	100	200	-	MHz
Phase Margin	$\phi_M$	40dB	-	25	-	deg.
Unity Gain Bandwidth	$f_T$	40dB	-	40	-	MHz

## ■ TYPICAL CHARACTERISTICS

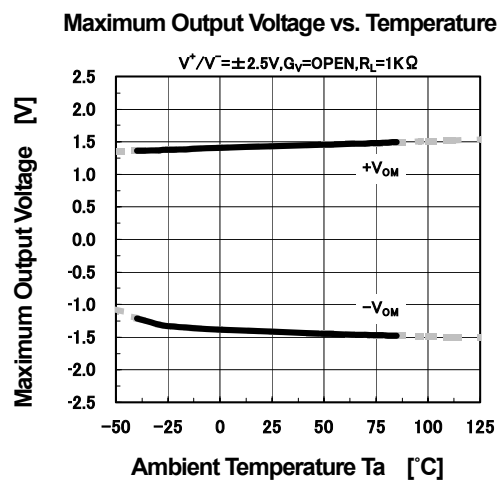
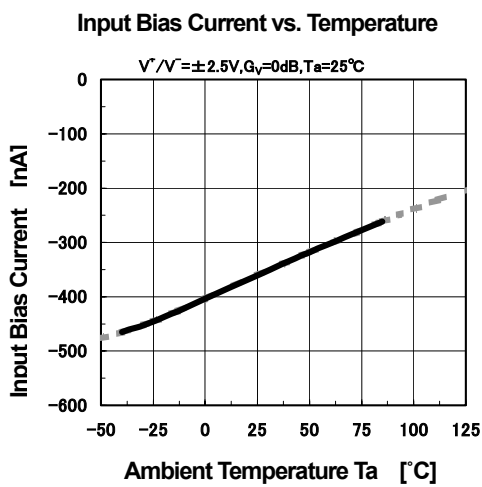
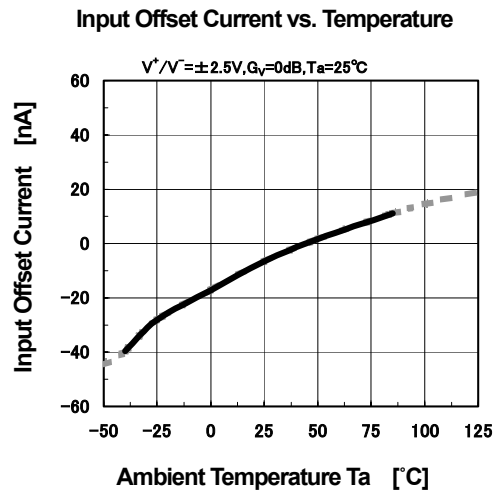
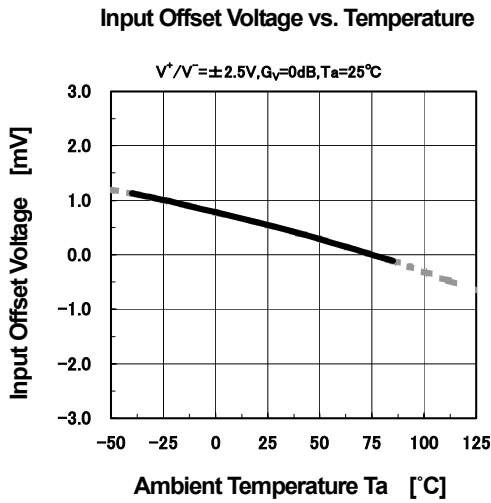
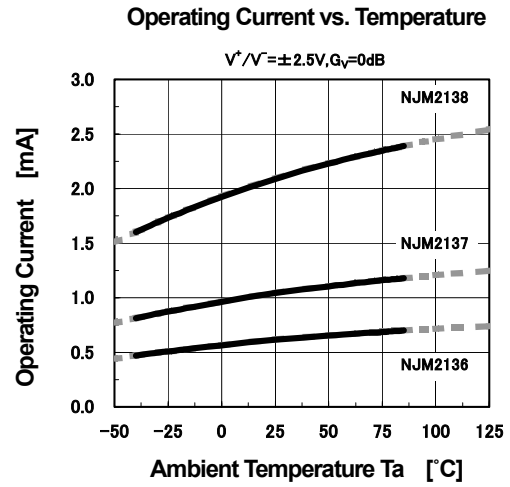
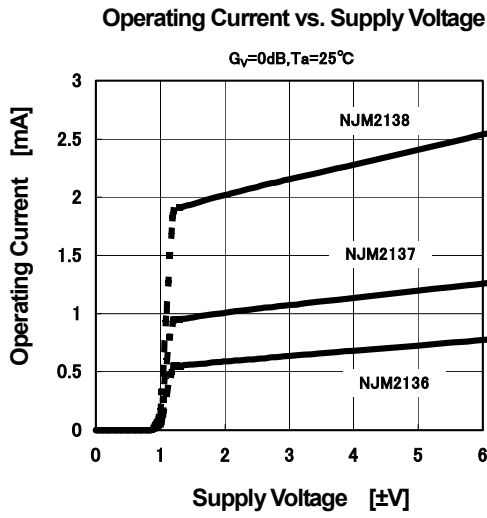

## ■ TYPICAL CHARACTERISTICS

Output Voltage vs. Load Resistance

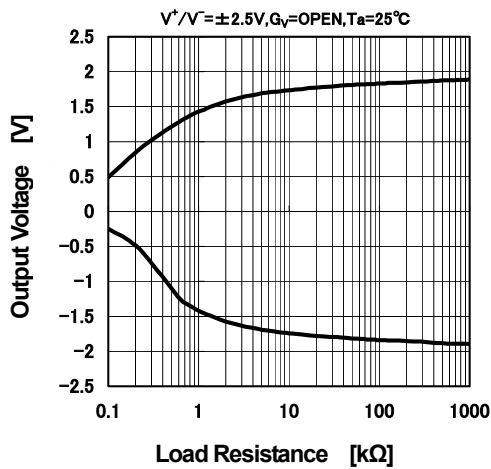

Maximum Output Voltage vs. Output Source Current

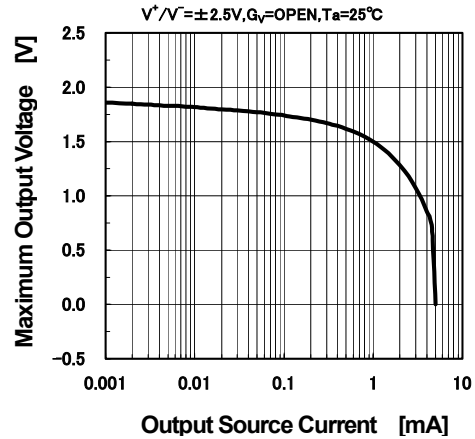

Maximum Output Voltage vs. Output Sink Current

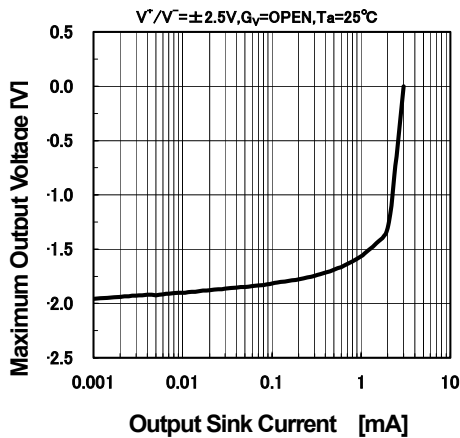

Total Harmonic Distortion vs. Output Voltage

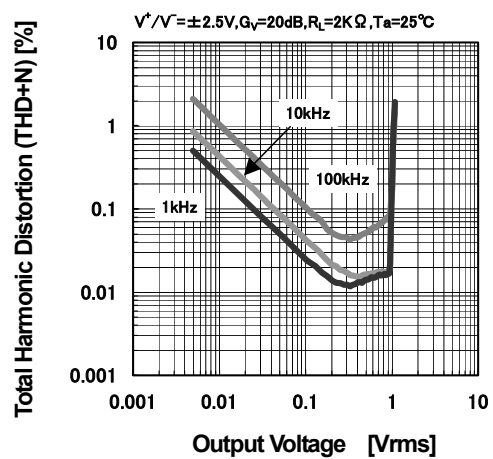

Total Harmonic Distortion vs. Output Voltage

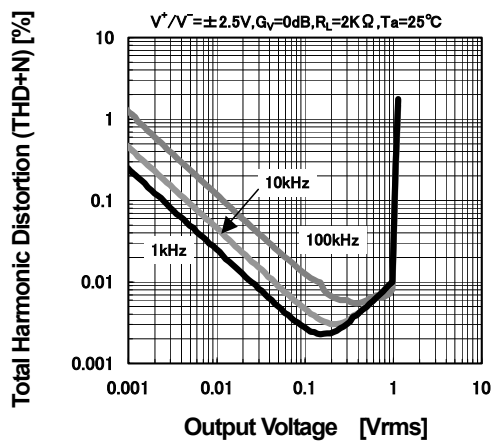

Voltage Gain, Phase vs. Frequency

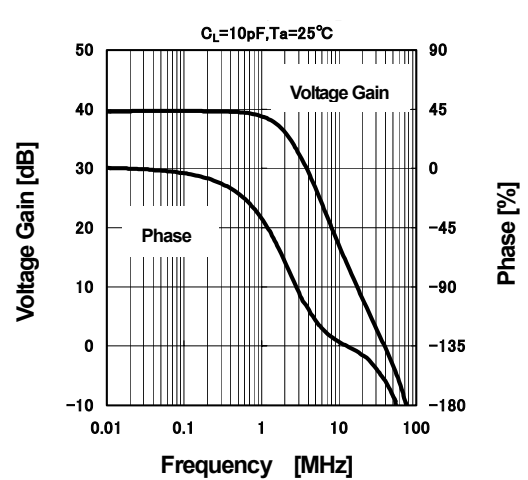

## ■ TYPICAL CHARACTERISTICS

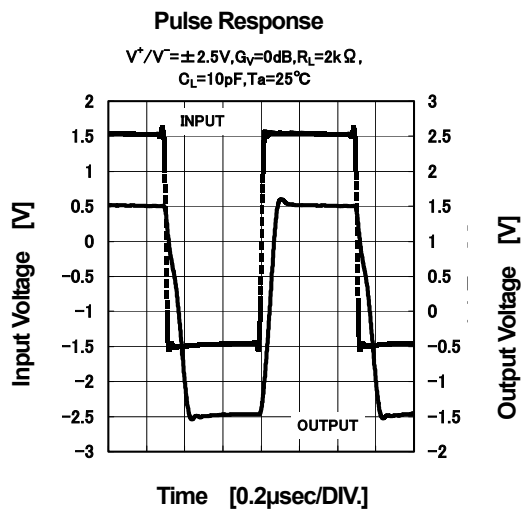
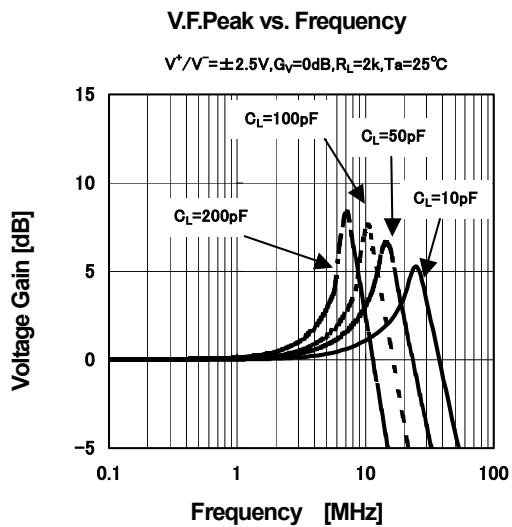

**[CAUTION]**

The specifications on this databook are only given for information, without any guarantee as regards either mistakes or omissions. The application circuits in this databook are described only to show representative usages of the product and not intended for the guarantee or permission of any right including the industrial rights.