

MAXIM

Miniature, 300MHz, Single-Supply, Rail-to-Rail Op Amps with Enable

General Description

The MAX4212/MAX4213 single, MAX4216 dual, MAX4218 triple, and MAX4220 quad op amps are unity-gain-stable devices that combine high-speed performance with Rail-to-Rail® outputs. The MAX4213/MAX4218 have a disable feature that reduces power-supply current to 400µA and places the outputs into a high-impedance state. These devices operate from a 3.3V to 10V single supply or from ±1.65V to ±5V dual supplies. The common-mode input voltage range extends beyond the negative power-supply rail (ground in single-supply applications).

These devices require only 5.5mA of quiescent supply current while achieving a 300MHz -3dB bandwidth and a 600V/µs slew rate. Input-voltage noise is only 10nV/√Hz and input-current noise is only 1.3pA/√Hz for either the inverting or noninverting input. These parts are an excellent solution in low-power/low-voltage systems that require wide bandwidth, such as video, communications, and instrumentation. In addition, when disabled, their high-output impedance makes them ideal for multiplexing applications.

The MAX4212 comes in a miniature 5-pin SOT23 package, while the MAX4213/MAX4216 come in 8-pin µMAX and SO packages. The MAX4218/MAX4220 are available in space-saving 16-pin QSOP and 14-pin SO packages.

Applications

Battery-Powered Instruments
Video Line Driver
Analog-to-Digital Converter Interface
CCD Imaging Systems
Video Routing and Switching Systems

Typical Operating Circuit

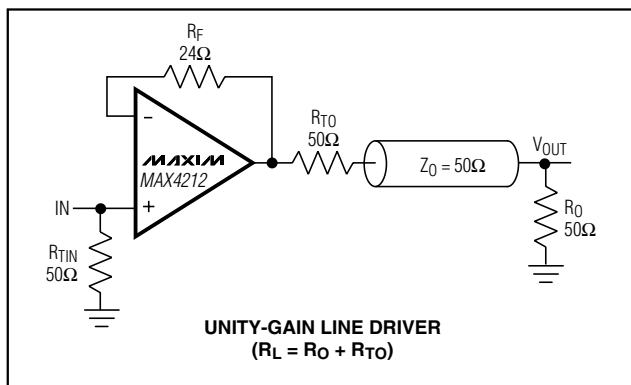

Rail-to-Rail is a registered trademark of Nippon Motorola, Ltd.

Features

- ◆ **High Speed:**
 - 300MHz -3dB Bandwidth (MAX4212/MAX4213)
 - 200MHz -3dB Bandwidth (MAX4216/MAX4218/MAX4220)
 - 50MHz 0.1dB Gain Flatness (MAX4212/MAX4213)
 - 600V/µs Slew Rate
- ◆ **Single 3.3V/5.0V Operation**
- ◆ **Rail-to-Rail Outputs**
- ◆ **Input Common-Mode Range Extends Beyond VEE**
- ◆ **Low Differential Gain/Phase: 0.02%/0.02°**
- ◆ **Low Distortion at 5MHz:**
 - 78dBc SFDR
 - 75dB Total Harmonic Distortion
- ◆ **High-Output Drive: ±100mA**
- ◆ **400µA Shutdown Capability (MAX4213/MAX4218)**
- ◆ **High-Output Impedance in Off State (MAX4213/MAX4218)**
- ◆ **Space-Saving SOT23, µMAX, or QSOP Packages**

Ordering Information

PART	TEMP RANGE	PIN PACKAGE	TOP MARK
MAX4212EUK-T	-40°C to +85°C	5 SOT23-5	ABAF
MAX4213ESA	-40°C to +85°C	8 SO	—
MAX4213EUA	-40°C to +85°C	8 µMAX	—

Ordering information continued at end of data sheet.

Pin Configurations

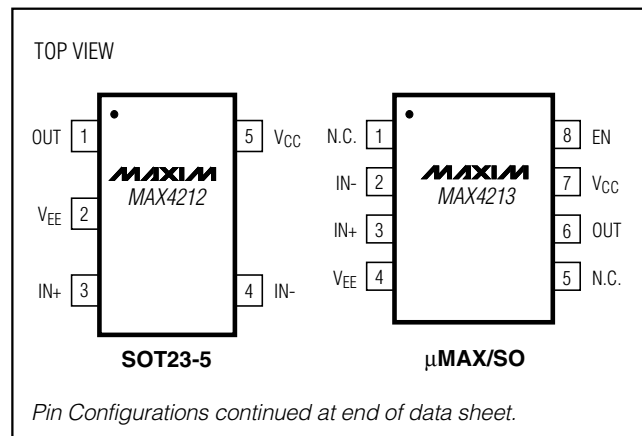
**MAXIM**

Maxim Integrated Products 1

For pricing, delivery, and ordering information, please contact Maxim/Dallas Direct! at 1-888-629-4642, or visit Maxim's website at www.maxim-ic.com.

MAX4212/MAX4213/MAX4216/MAX4218/MAX4220

Miniature, 300MHz, Single-Supply, Rail-to-Rail Op Amps with Enable

ABSOLUTE MAXIMUM RATINGS

Supply Voltage (V _{CC} to V _{EE})12V	8-Pin μ MAX (derate 4.5mW/°C above +70°C)221mW
IN ₋ , IN ₊ , OUT ₋ , EN ₋(V _{EE} - 0.3V) to (V _{CC} + 0.3V)	14-Pin SO (derate 8.3mW/°C above +70°C)667mW
Output Short-Circuit Duration to V _{CC} or V _{EE} Continuous	16-Pin QSOP (derate 8.3mW/°C above +70°C)667mW
Continuous Power Dissipation (T _A = +70°C)		Operating Temperature Range-40°C to +85°C
5-Pin SOT23 (derate 7.1mW/°C above +70°C)571mW	Storage Temperature Range-65°C to +150°C
8-Pin SO (derate 5.9mW/°C above +70°C)471mW	Lead Temperature (soldering, 10s)+300°C

Stresses beyond those listed under "Absolute Maximum Ratings" may cause permanent damage to the device. These are stress ratings only, and functional operation of the device at these or at any other conditions beyond those indicated in the operational sections of the specifications is not implied. Exposure to absolute maximum rating conditions for extended periods may affect device reliability.

DC ELECTRICAL CHARACTERISTICS

(V_{CC} = 5V, V_{EE} = 0, EN₋ = 5V, R_L = 2k Ω to V_{CC}/2, V_{OUT} = V_{CC}/2, T_A = T_{MIN} to T_{MAX}, unless otherwise noted. Typical values are at T_A = +25°C.)

PARAMETER	SYMBOL	CONDITIONS	MIN	TYP	MAX	UNITS
Input Common-Mode Voltage Range	V _{CM}	Guaranteed by CMRR test	V _{EE} - 0.20		V _{CC} - 2.25	V
Input Offset Voltage (Note 1)	V _{OS}	MAX4212EUK, MAX421_EUA		4	12	mV
		MAX42_ _ES_, MAX42_ _EEE		4	9	
Input Offset Voltage Temperature Coefficient	TC _{VOS}			8		μ V/°C
Input Offset Voltage Matching		Any channels for MAX4216/MAX4218/MAX4220		\pm 1		mV
Input Bias Current	I _B	(Note 1)		5.4	20	μ A
Input Offset Current	I _{OS}	(Note 1)		0.1	4.0	μ A
Input Resistance	R _{IN}	Differential mode (-1V \leq V _{IN} \leq +1V)		70		k Ω
		Common mode (-0.2V \leq V _{CM} \leq +2.75V)		3		M Ω
Common-Mode Rejection Ratio	CMRR	(V _{EE} - 0.2V) \leq V _{CM} \leq (V _{CC} - 2.25V)	70	100		dB
Open-Loop Gain (Note 1)	A _{VOL}	0.25V \leq V _{OUT} \leq 4.75V, R _L = 2k Ω	55	61		dB
		0.5V \leq V _{OUT} \leq 4.5V, R _L = 150 Ω	52	59		
		1.0V \leq V _{OUT} \leq 4V, R _L = 50 Ω		57		
Output Voltage Swing	V _{OUT}	R _L = 10k Ω	V _{CC} - V _{OH}	0.05		V
			V _{OL} - V _{EE}	0.05		
		R _L = 2k Ω	V _{CC} - V _{OH}	0.06	0.20	
			V _{OL} - V _{EE}	0.06	0.20	
		R _L = 150 Ω	V _{CC} - V _{OH}	0.30	0.50	
			V _{OL} - V _{EE}	0.30	0.50	
R _L = 50 Ω	V _{CC} - V _{OH}	0.70				
	V _{OL} - V _{EE}	0.60				

Miniature, 300MHz, Single-Supply, Rail-to-Rail Op Amps with Enable

MAX4212/MAX4213/MAX4216/MAX4218/MAX4220

DC ELECTRICAL CHARACTERISTICS (continued)

($V_{CC} = 5V$, $V_{EE} = 0$, $EN_ = 5V$, $R_L = 2k\Omega$ to $V_{CC}/2$, $V_{OUT} = V_{CC}/2$, $T_A = T_{MIN}$ to T_{MAX} , unless otherwise noted. Typical values are at $T_A = +25^\circ C$.)

PARAMETER	SYMBOL	CONDITIONS	MIN	TYP	MAX	UNITS
Output Current	I_{OUT}	$R_L = 20\Omega$ to V_{CC} or V_{EE}	$T_A = +25^\circ C$	± 70	± 120	mA
			$T_A = T_{MIN}$ to T_{MAX}	± 60		
Output Short-Circuit Current	I_{SC}	Sinking or sourcing		± 150		mA
Open-Loop Output Resistance	R_{OUT}			8		Ω
Power-Supply Rejection Ratio (Note 2)	PSRR	$V_{CC} = 5V$, $V_{EE} = 0$, $V_{CM} = 2.0V$	46	57		dB
		$V_{CC} = 5V$, $V_{EE} = -5V$, $V_{CM} = 0$	54	66		
		$V_{CC} = 3.3V$, $V_{EE} = 0$, $V_{CM} = 0.90V$		45		
Operating Supply-Voltage Range	V_S	V_{CC} to V_{EE}	3.15		11.0	V
Disabled Output Resistance	$R_{OUT(OFF)}$	$EN_ = 0$, $0 \leq V_{OUT} \leq 5V$ (Note 3)	20	35		$k\Omega$
$EN_$ Logic-Low Threshold	V_{IL}				$V_{CC} - 2.6$	V
$EN_$ Logic-High Threshold	V_{IH}		$V_{CC} - 1.6$			V
$EN_$ Logic Input Low Current	I_{IL}	$(V_{EE} + 0.2V) \leq EN_ \leq V_{CC}$		0.5		μA
		$EN_ = 0$		200	400	
$EN_$ Logic Input High Current	I_{IH}	$EN_ = 5V$		0.5	10	μA
Quiescent Supply Current (per Amplifier)	I_S	Enabled		5.5	7.0	mA
		Disabled ($EN_ = 0$)		0.40	0.65	

Miniature, 300MHz, Single-Supply, Rail-to-Rail Op Amps with Enable

AC ELECTRICAL CHARACTERISTICS

($V_{CC} = 5V$, $V_{EE} = 0$, $V_{CM} = 2.5V$, $EN_{-} = 5V$, $R_F = 24\Omega$, $R_L = 100\Omega$ to $V_{CC}/2$, $V_{OUT} = V_{CC}/2$, $Av_{CL} = +1$, $T_A = +25^{\circ}C$, unless otherwise noted.)

PARAMETER	SYMBOL	CONDITIONS		MIN	TYP	MAX	UNITS
Small-Signal -3dB Bandwidth	BW _{SS}	$V_{OUT} = 20mV_{P-P}$	MAX4212/MAX4213	300			MHz
			MAX4216/MAX4218/MAX4220	200			
Large-Signal -3dB Bandwidth	BW _{LS}	$V_{OUT} = 2V_{P-P}$		180			MHz
Bandwidth for 0.1dB Gain Flatness	BW _{0.1dB}	$V_{OUT} = 20mV_{P-P}$	MAX4212/MAX4213	50			MHz
			MAX4216/MAX4218/MAX4220	35			
Slew Rate	SR	$V_{OUT} = 2V$ step		600			V/ μ s
Settling Time to 0.1%	t_S	$V_{OUT} = 2V$ step		45			ns
Rise/Fall Time	t_R , t_F	$V_{OUT} = 100mV_{P-P}$		1			ns
Spurious-Free Dynamic Range	SFDR	$f_C = 5MHz$, $V_{OUT} = 2V_{P-P}$		-78			dBc
Harmonic Distortion	HD	$f_C = 5MHz$, $V_{OUT} = 2V_{P-P}$	2nd harmonic	-78			dBc
			3rd harmonic	-82			
			Total harmonic distortion	-75			dB
Two-Tone, Third-Order Intermodulation Distortion	IP3	$f_1 = 10.0MHz$, $f_2 = 10.1MHz$, $V_{OUT} = 1V_{P-P}$		35			dBc
Input 1dB Compression Point		$f_C = 10MHz$, $Av_{CL} = 2$		11			dBm
Differential Phase Error	DP	NTSC, $R_L = 150\Omega$		0.02			degrees
Differential Gain Error	DG	NTSC, $R_L = 150\Omega$		0.02			%
Input Noise-Voltage Density	e_n	$f = 10kHz$		10			nV/ \sqrt{Hz}
Input Noise-Current Density	i_n	$f = 10kHz$		1.3			pA/ \sqrt{Hz}
Input Capacitance	C_{IN}			1			pF
Disabled Output Capacitance	$C_{OUT(OFF)}$	$EN_{-} = 0$		2			pF
Output Impedance	Z_{OUT}	$f = 10MHz$		6			Ω
Amplifier Enable Time	t_{ON}			100			ns
Amplifier Disable Time	t_{OFF}			1			μ s
Amplifier Gain Matching		MAX4216/MAX4218/MAX4220, $f = 10MHz$, $V_{OUT} = 20mV_{P-P}$		0.1			dB
Amplifier Crosstalk	X _{TALK}	MAX4216/MAX4218/MAX4220, $f = 10MHz$, $V_{OUT} = 2V_{P-P}$		-95			dB

Note 1: Tested with $V_{CM} = 2.5V$.

Note 2: PSR for single 5V supply tested with $V_{EE} = 0$, $V_{CC} = 4.5V$ to $5.5V$; for dual $\pm 5V$ supply with $V_{EE} = -4.5V$ to $-5.5V$, $V_{CC} = 4.5V$ to $5.5V$; and for single 3.3V supply with $V_{EE} = 0$, $V_{CC} = 3.15V$ to $3.45V$.

Note 3: Does not include the external feedback network's impedance.

Miniature, 300MHz, Single-Supply, Rail-to-Rail Op Amps with Enable

Typical Operating Characteristics

($V_{CC} = 5V$, $V_{EE} = 0$, $A_{VCL} = 1$, $R_F = 24\Omega$, $R_L = 100\Omega$ to $V_{CC}/2$, $T_A = +25^\circ C$, unless otherwise noted.)

MAX4212/MAX4213/MAX4216/MAX4218/MAX4220

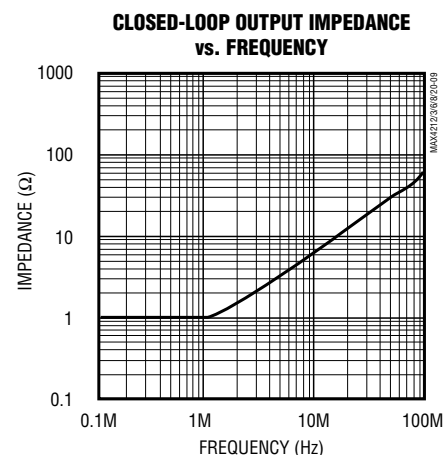
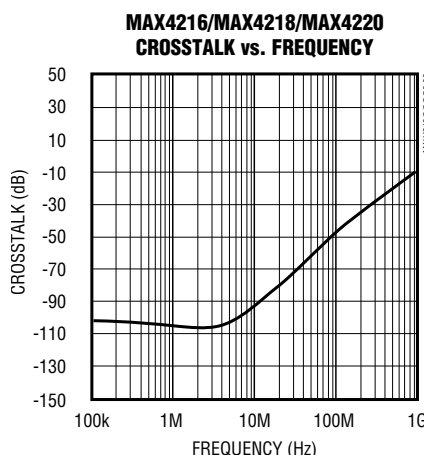
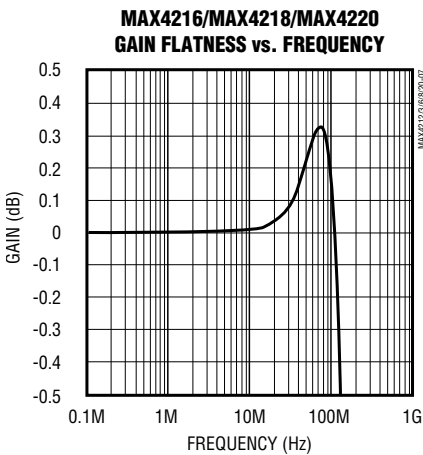
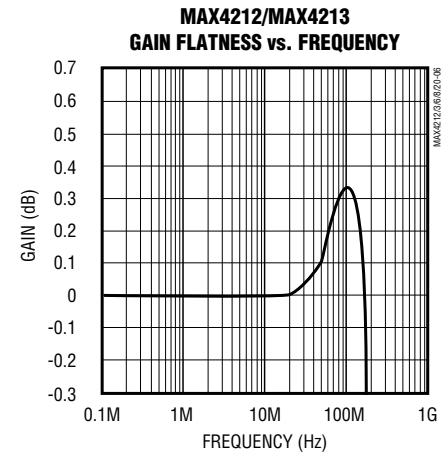
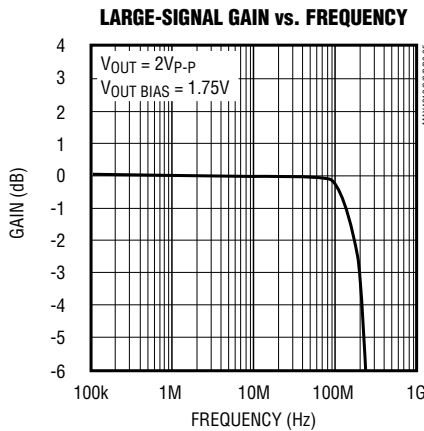
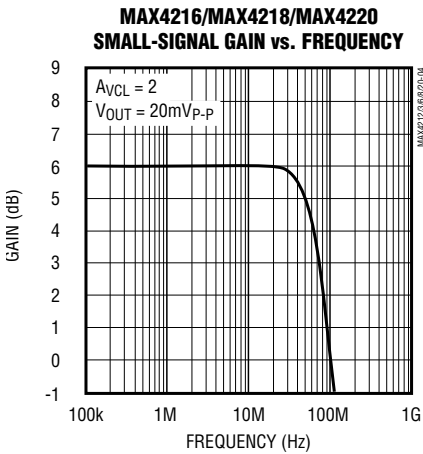
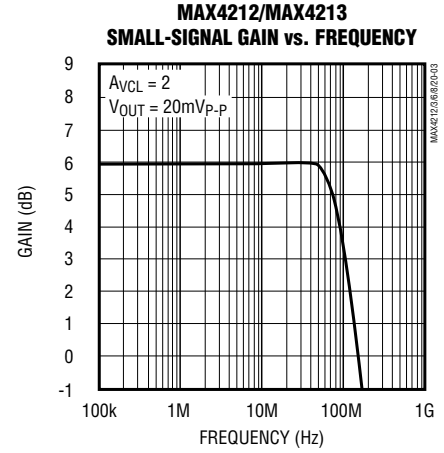
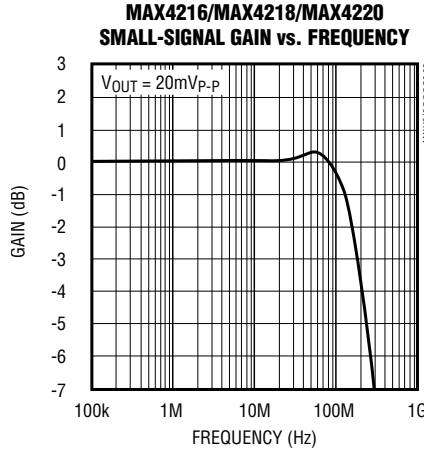
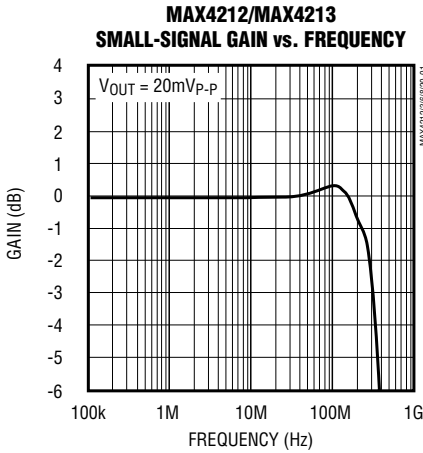

Miniature, 300MHz, Single-Supply, Rail-to-Rail Op Amps with Enable

Typical Operating Characteristics (continued)

($V_{CC} = 5V$, $V_{EE} = 0$, $A_{VCL} = 1$, $R_F = 24\Omega$, $R_L = 100\Omega$ to $V_{CC}/2$, $T_A = +25^\circ C$, unless otherwise noted.)

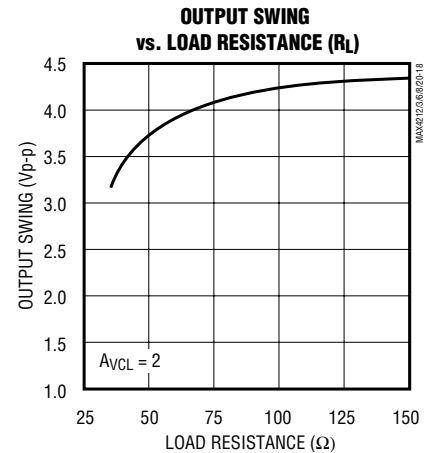
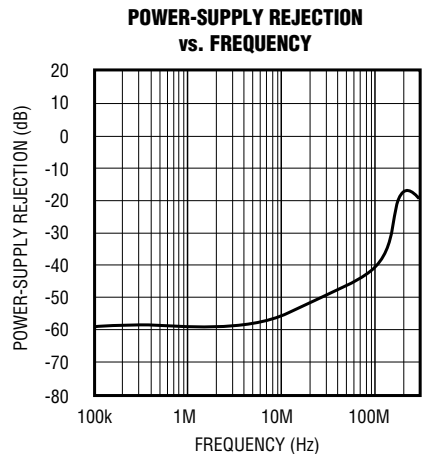
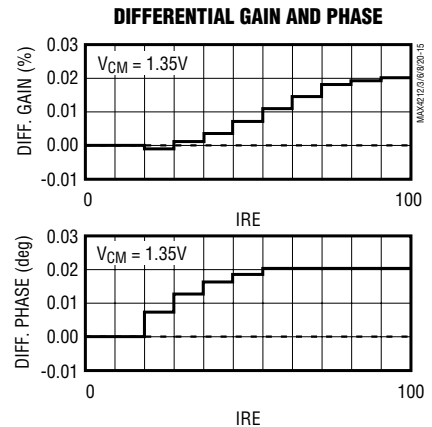
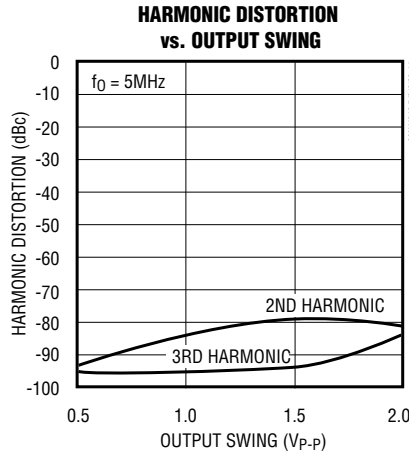
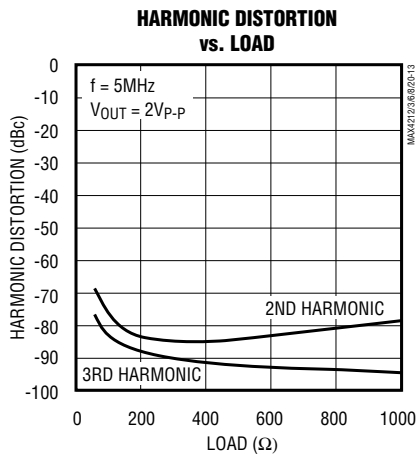
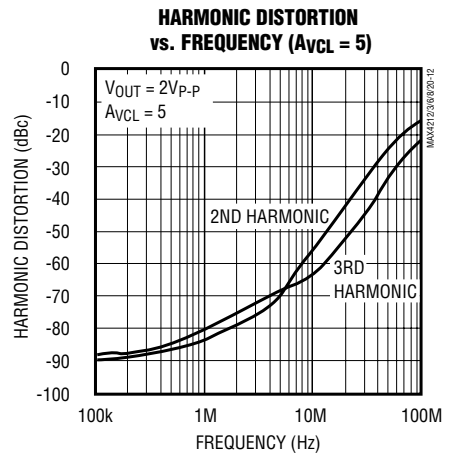
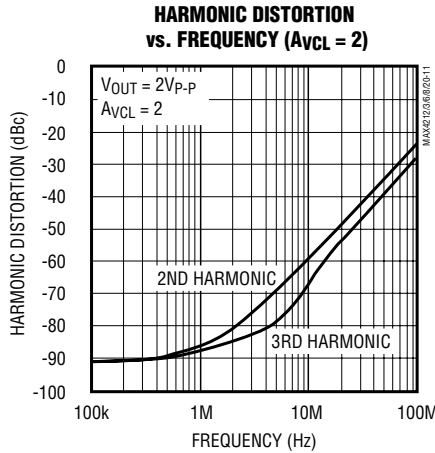
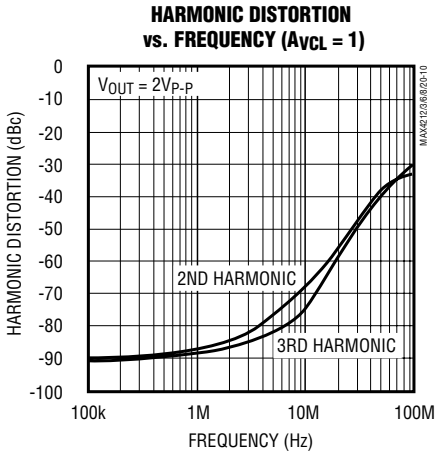

Miniature, 300MHz, Single-Supply, Rail-to-Rail Op Amps with Enable

Typical Operating Characteristics (continued)

($V_{CC} = 5V$, $V_{EE} = 0$, $A_{vCL} = 1$, $R_F = 24\Omega$, $R_L = 100\Omega$ to $V_{CC}/2$, $T_A = +25^\circ C$, unless otherwise noted.)

SMALL-SIGNAL PULSE RESPONSE
($A_{vCL} = 1$)

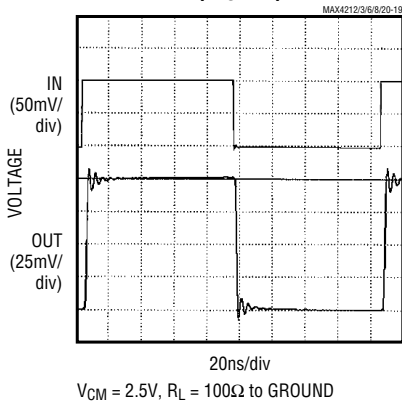

SMALL-SIGNAL PULSE RESPONSE
($A_{vCL} = 2$)

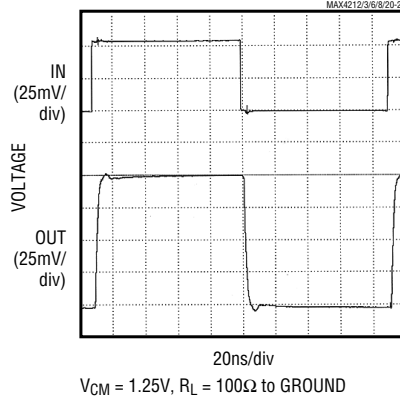

SMALL-SIGNAL PULSE RESPONSE
($C_L = 5pF$, $A_{vCL} = 1$)

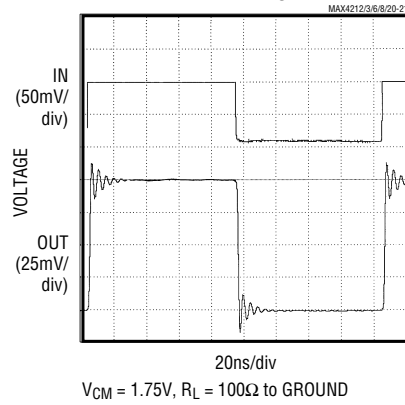

LARGE-SIGNAL PULSE RESPONSE
($A_{vCL} = 1$)

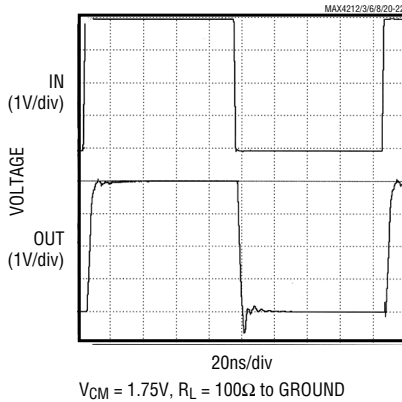

LARGE-SIGNAL PULSE RESPONSE
($A_{vCL} = 2$)

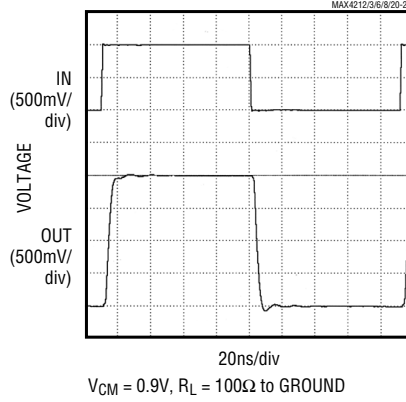

LARGE-SIGNAL PULSE RESPONSE
($C_L = 5pF$, $A_{vCL} = 2$)

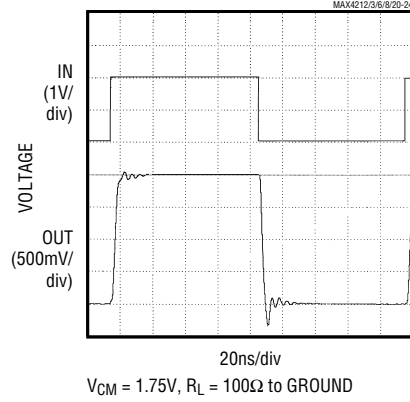

MAX4213
VOLTAGE-NOISE DENSITY
vs. FREQUENCY

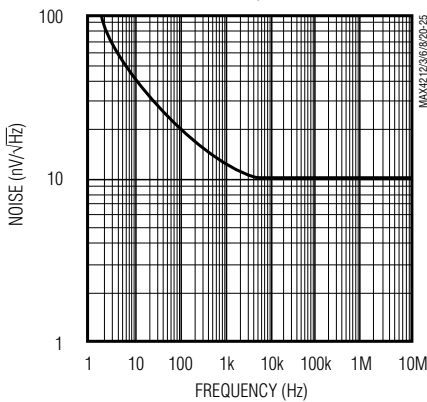

MAX4218
CURRENT-NOISE DENSITY
vs. FREQUENCY

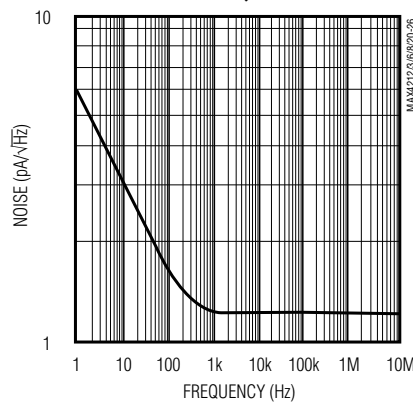

ENABLE RESPONSE TIME

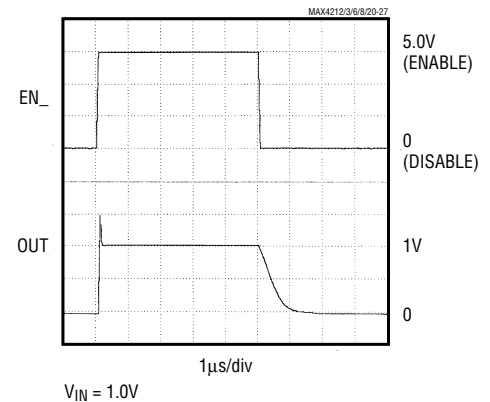

MAX4212/MAX4213/MAX4216/MAX4218/MAX4220

Miniature, 300MHz, Single-Supply, Rail-to-Rail Op Amps with Enable

Typical Operating Characteristics (continued)

($V_{CC} = 5V$, $V_{EE} = 0$, $A_{vCL} = 1$, $R_F = 24\Omega$, $R_L = 100\Omega$ to $V_{CC}/2$, $T_A = +25^\circ C$, unless otherwise noted.)

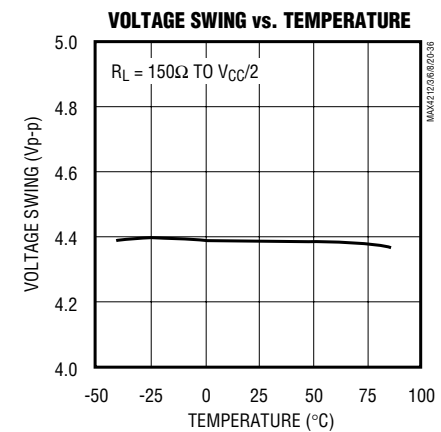
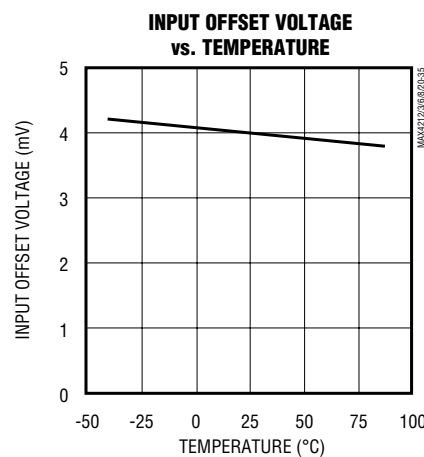
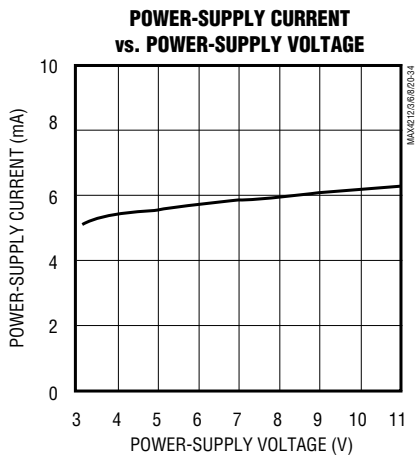
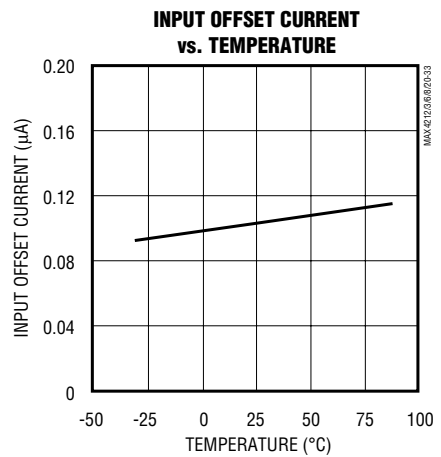
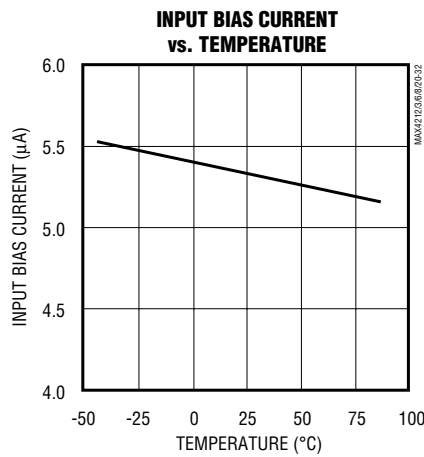
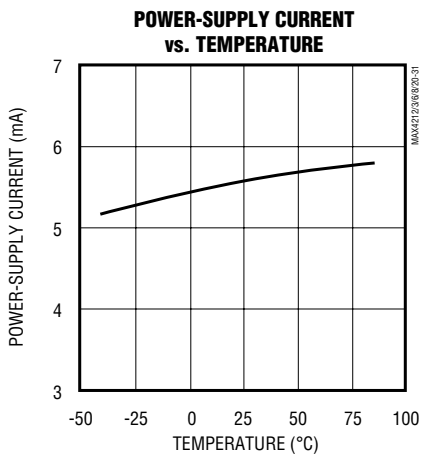
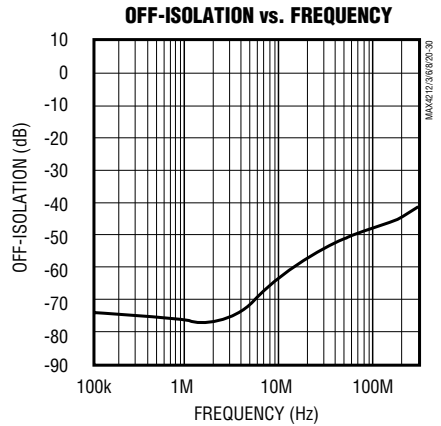
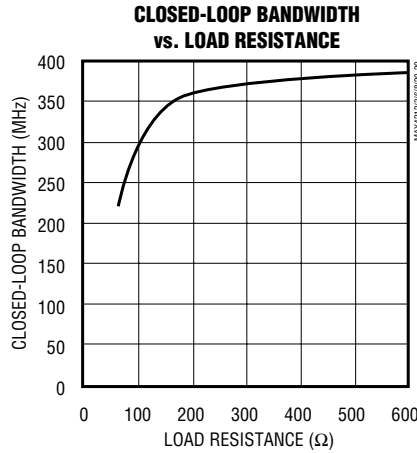

Miniature, 300MHz, Single-Supply, Rail-to-Rail Op Amps with Enable

Pin Description

PIN							NAME	FUNCTION
MAX4212 SOT23	MAX4213 SO/μMAX	MAX4216 SO/μMAX	MAX4218		MAX4220			
			SO	QSOP	SO	QSOP		
—	1, 5	—	—	8, 9	—	8, 9	N.C.	No Connection. Not internally connected. Tie to ground or leave open.
1	6	—	—	—	—	—	OUT	Amplifier Output
2	4	4	11	13	11	13	VEE	Negative Power Supply or Ground (in single-supply operation)
3	3	—	—	—	—	—	IN+	Noninverting Input
4	2	—	—	—	—	—	IN-	Inverting Input
5	7	8	4	4	4	4	VCC	Positive Power Supply
—	—	1	7	7	1	1	OUTA	Amplifier A Output
—	—	2	6	6	2	2	INA-	Amplifier A Inverting Input
—	—	3	5	5	3	3	INA+	Amplifier A Noninverting Input
—	—	7	8	10	7	7	OUTB	Amplifier B Output
—	—	6	9	11	6	6	INB-	Amplifier B Inverting Input
—	—	5	10	12	5	5	INB+	Amplifier B Noninverting Input
—	—	—	14	16	8	10	OUTC	Amplifier C Output
—	—	—	13	15	9	11	INC-	Amplifier C Inverting Input
—	—	—	12	14	10	12	INC+	Amplifier C Noninverting Input
—	—	—	—	—	14	16	OUTD	Amplifier D Output
—	—	—	—	—	13	15	IND-	Amplifier D Inverting Input
—	—	—	—	—	12	14	IND+	Amplifier D Noninverting Input
—	8	—	—	—	—	—	EN	Enable Amplifier
—	—	—	1	1	—	—	ENA	Enable Amplifier A
—	—	—	3	3	—	—	ENB	Enable Amplifier B
—	—	—	2	2	—	—	ENC	Enable Amplifier C

MAX4212/MAX4213/MAX4216/MAX4218/MAX4220

Miniature, 300MHz, Single-Supply, Rail-to-Rail Op Amps with Enable

Detailed Description

The MAX4212/MAX4213/MAX4216/MAX4218/MAX4220 are single-supply, rail-to-rail, voltage-feedback amplifiers that employ current-feedback techniques to achieve 600V/ μ s slew rates and 300MHz bandwidths. Excellent harmonic distortion and differential gain/phase performance make these amplifiers an ideal choice for a wide variety of video and RF signal-processing applications.

The output voltage swing comes to within 50mV of each supply rail. Local feedback around the output stage assures low open-loop output impedance to reduce gain sensitivity to load variations. This feedback also produces demand-driven current bias to the output transistors for ± 100 mA drive capability, while constraining total supply current to less than 7mA. The input stage permits common-mode voltages beyond the negative supply and to within 2.25V of the positive supply rail.

Applications Information

Choosing Resistor Values

Unity-Gain Configuration

The MAX4212/MAX4213/MAX4216/MAX4218/MAX4220 are internally compensated for unity gain. When configured for unity gain, the devices require a 24 Ω resistor (R_F) in series with the feedback path. This resistor

improves AC response by reducing the Q of the parallel LC circuit formed by the parasitic feedback capacitance and inductance.

Inverting and Noninverting Configurations

Select the gain-setting feedback (R_F) and input (R_G) resistor values to fit your application. Large resistor values increase voltage noise and interact with the amplifier's input and PC board capacitance. This can generate undesirable poles and zeros and decrease bandwidth or cause oscillations. For example, a noninverting gain-of-two configuration ($R_F = R_G$) using 1k Ω resistors, combined with 1pF of amplifier input capacitance and 1pF of PC board capacitance, causes a pole at 159MHz. Since this pole is within the amplifier bandwidth, it jeopardizes stability. Reducing the 1k Ω resistors to 100 Ω extends the pole frequency to 1.59GHz, but could limit output swing by adding 200 Ω in parallel with the amplifier's load resistor. Table 1 shows suggested feedback, gain resistors, and bandwidth for several gain values in the configurations shown in Figures 1a and 1b.

Layout and Power-Supply Bypassing

These amplifiers operate from a single 3.3V to 11V power supply or from dual supplies to ± 5.5 V. For single-supply operation, bypass VCC to ground with a 0.1 μ F capacitor as close to the pin as possible. If operating with dual supplies, bypass each supply with a 0.1 μ F capacitor.

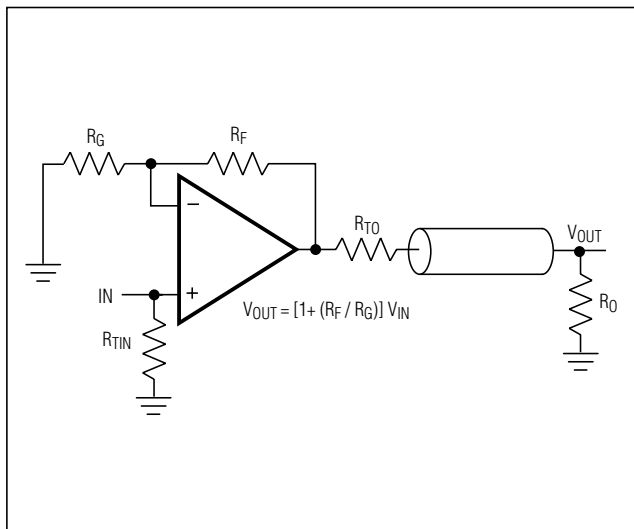

Figure 1a. Noninverting Gain Configuration

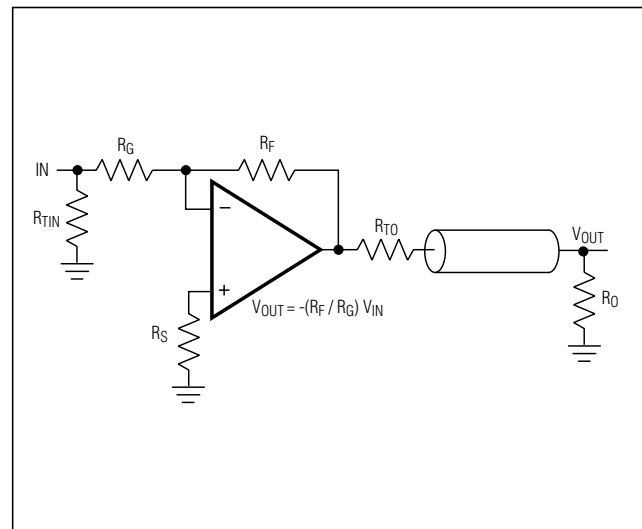

Figure 1b. Inverting Gain Configuration

Miniature, 300MHz, Single-Supply, Rail-to-Rail Op Amps with Enable

Maxim recommends using microstrip and stripline techniques to obtain full bandwidth. To ensure that the PC board does not degrade the amplifier's performance, design it for a frequency greater than 1GHz. Pay careful attention to inputs and outputs to avoid large parasitic capacitance. Whether or not you use a constant-impedance board, observe the following guidelines when designing the board:

- Don't use wire-wrap boards because they are too inductive.
- Don't use IC sockets because they increase parasitic capacitance and inductance.
- Use surface-mount instead of through-hole components for better high-frequency performance.
- Use a PC board with at least two layers; it should be as free from voids as possible.
- Keep signal lines as short and as straight as possible. Do not make 90° turns; round all corners.

Rail-to-Rail Outputs, Ground-Sensing Input

The input common-mode range extends from (V_{EE} - 200mV) to (V_{CC} - 2.25V) with excellent common-mode rejection. Beyond this range, the amplifier output is a nonlinear function of the input, but does not undergo phase reversal or latchup.

The output swings to within 50mV of either power-supply rail with a 10kΩ load. The input ground-sensing and the rail-to-rail output substantially increase the dynamic range. With a symmetric input in a single 5V application, the input can swing 2.95V_{P-P}, and the output can swing 4.9V_{P-P} with minimal distortion.

Enable Input and Disabled Output

The enable feature (EN₋) allows the amplifier to be placed in a low-power, high-output-impedance state. Typically, the EN₋ logic low input current (I_{IL}) is small. However, as the EN voltage (V_{IL}) approaches the negative supply rail, I_{IL} increases (Figure 2). A single resistor connected as shown in Figure 3 prevents the rise in the logic-low input current. This resistor provides a feedback mechanism that increases V_{IL} as the logic input is brought to V_{EE}. Figure 4 shows the resulting input current (I_{IL}).

When the MAX4213/MAX4218 are disabled, the amplifier's output impedance is 35kΩ. This high resistance and the low 2pF output capacitance make these parts ideal in RF/video multiplexer or switch applications. For larger arrays, pay careful attention to capacitive loading. See the *Output Capacitive Loading and Stability* section for more information.

Table 1. Recommended Component Values

COMPONENT	GAIN (V/V)									
	+1	-1	+2	-2	+5	-5	+10	-10	+25	-25
R _F (Ω)	24	500	500	500	500	500	500	500	500	1200
R _G (Ω)	∞	500	500	250	124	100	56	50	20	50
R _S (Ω)	—	0	—	0	—	0	—	0	—	0
R _{TIN} (Ω)	49.9	56	49.9	62	49.9	100	49.9	∞	49.9	∞
R _{TO} (Ω)	49.9	49.9	49.9	49.9	49.9	49.9	49.9	49.9	49.9	49.9
Small-Signal -3dB Bandwidth (MHz)	300	90	105	60	25	33	11	25	6	10

Note: R_L = R_O + R_{TO}; R_{TIN} and R_{TO} are calculated for 50Ω applications. For 75Ω systems, R_{TO} = 75Ω; calculate R_{TIN} from the following equation:

$$R_{TIN} = \frac{75}{1 - \frac{75}{R_G}} \Omega$$

Miniature, 300MHz, Single-Supply, Rail-to-Rail Op Amps with Enable

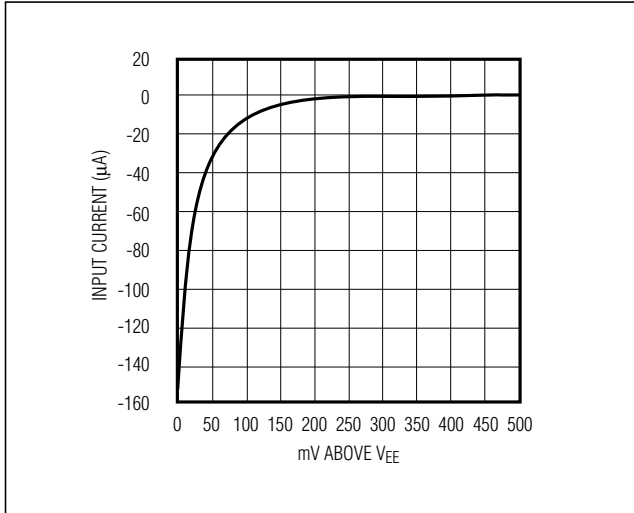

Figure 2. Enable Logic-Low Input Current vs. V_{IL}

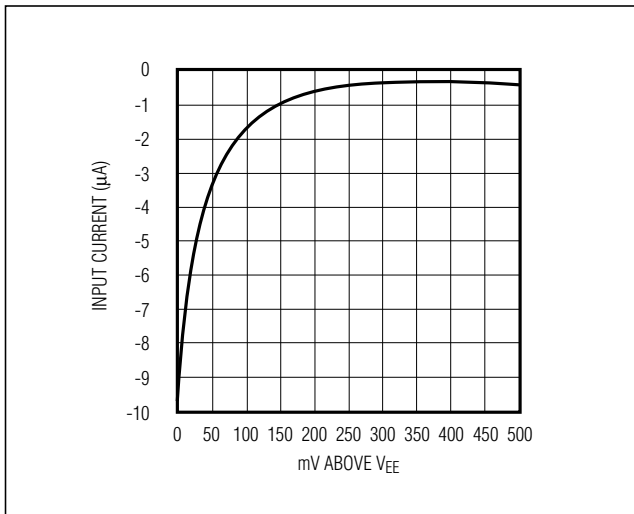

Figure 4. Enable Logic-Low Input Current vs. V_{IL} with 10kΩ Series Resistor

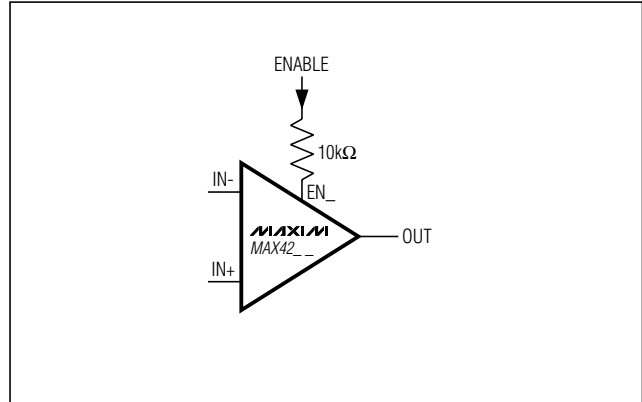

Figure 3. Circuit to Reduce Enable Logic-Low Input Current

Output Capacitive Loading and Stability

The MAX4212/MAX4213/MAX4216/MAX4218/MAX4220 are optimized for AC performance. They are not designed to drive highly reactive loads, which decreases phase margin and may produce excessive ringing and oscillation. Figure 5 shows a circuit that eliminates this problem. Figure 6 is a graph of the optimal isolation resistor (R_S) vs. capacitive load. Figure 7 shows how a capacitive load causes excessive peaking of the amplifier's frequency response if the capacitor is not isolated from the amplifier by a resistor. A small isolation resistor (usually 20Ω to 30Ω) placed before the reactive load prevents ringing and oscillation. At higher capacitive loads, AC performance is controlled by the interaction of the load capacitance and the isolation resistor. Figure 8 shows the effect of a 27Ω isolation resistor on closed-loop response.

Coaxial cable and other transmission lines are easily driven when properly terminated at both ends with their characteristic impedance. Driving back-terminated transmission lines essentially eliminates the line's capacitance.

Miniature, 300MHz, Single-Supply, Rail-to-Rail Op Amps with Enable

MAX4212/MAX4213/MAX4216/MAX4218/MAX4220

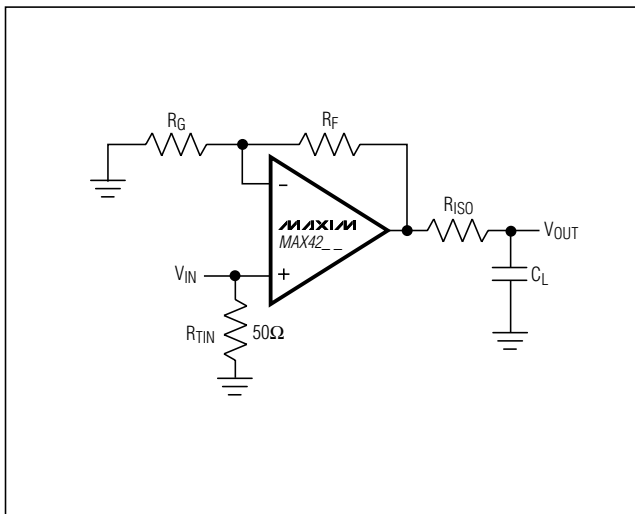

Figure 5. Driving a Capacitive Load through an Isolation Resistor

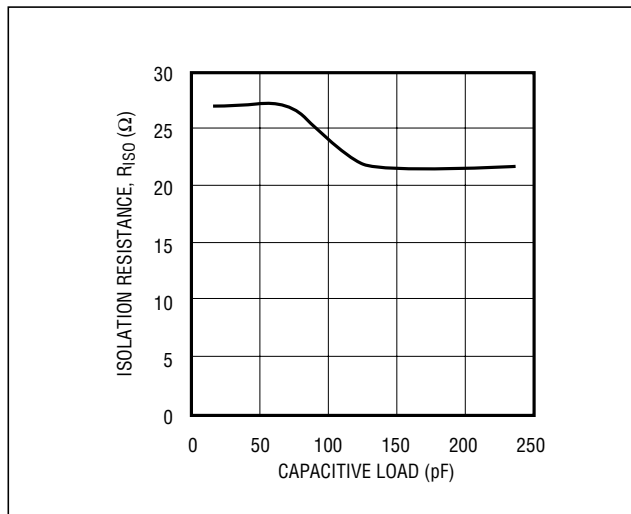

Figure 6. Capacitive Load vs. Isolation Resistance

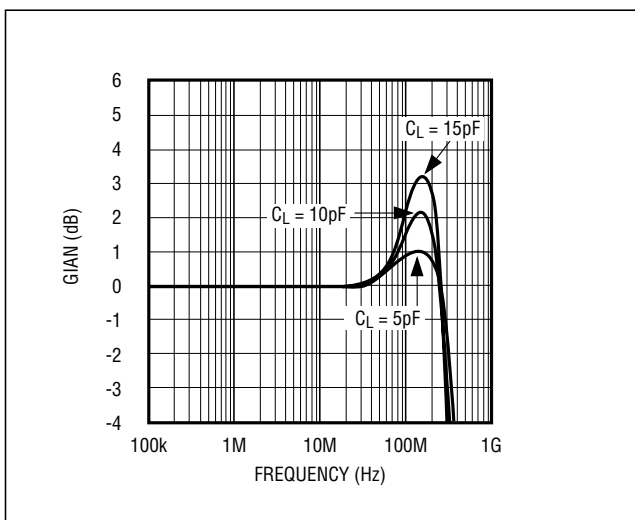

Figure 7. Small-Signal Gain vs. Frequency with Load Capacitance and No Isolation Resistor

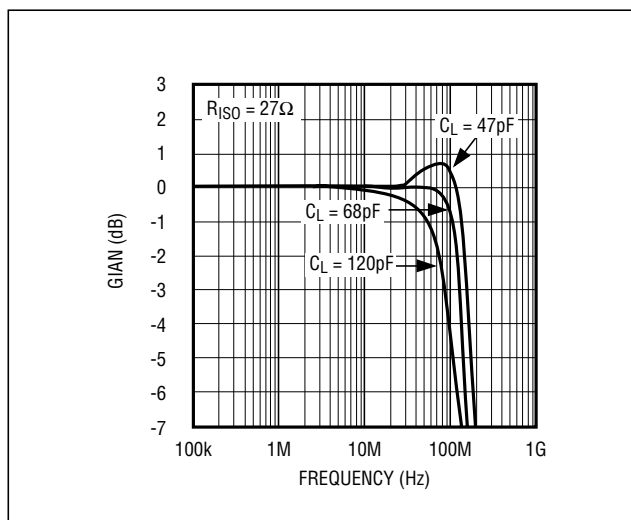
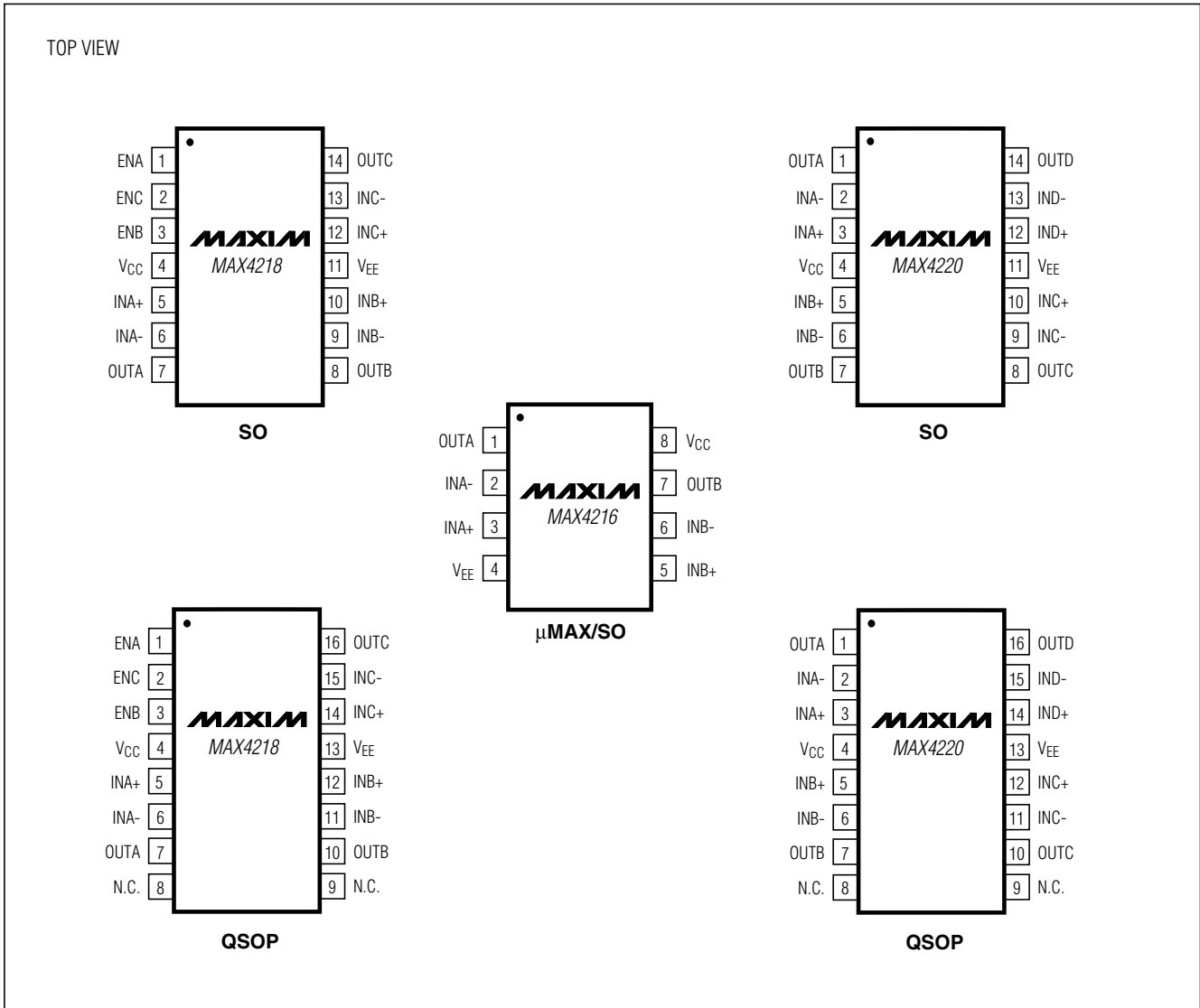

Figure 8. Small-Signal Gain vs. Frequency with Load Capacitance and 27Ω Isolation Resistor

Miniature, 300MHz, Single-Supply, Rail-to-Rail Op Amps with Enable

Pin Configurations (continued)



Miniature, 300MHz, Single-Supply, Rail-to-Rail Op Amps with Enable

MAX4212/MAX4213/MAX4216/MAX4218/MAX4220

Ordering Information (continued)

Chip Information

PART	TEMP RANGE	PIN PACKAGE	TOP MARK
MAX4216ESA	-40°C to +85°C	8 SO	—
MAX4216EUA	-40°C to +85°C	8 μ MAX	—
MAX4218ESD	-40°C to +85°C	14 SO	—
MAX4218EEE	-40°C to +85°C	16 QSOP	—
MAX4220ESD	-40°C to +85°C	14 SO	—
MAX4220EEE	-40°C to +85°C	16 QSOP	—

MAX4212/MAX4213 TRANSISTOR COUNT: 95

MAX4216 TRANSISTOR COUNT: 190

MAX4218 TRANSISTOR COUNT: 299

MAX4220 TRANSISTOR COUNT: 362

Package Information

(The package drawing(s) in this data sheet may not reflect the most current specifications. For the latest package outline information, go to www.maxim-ic.com/packages.)

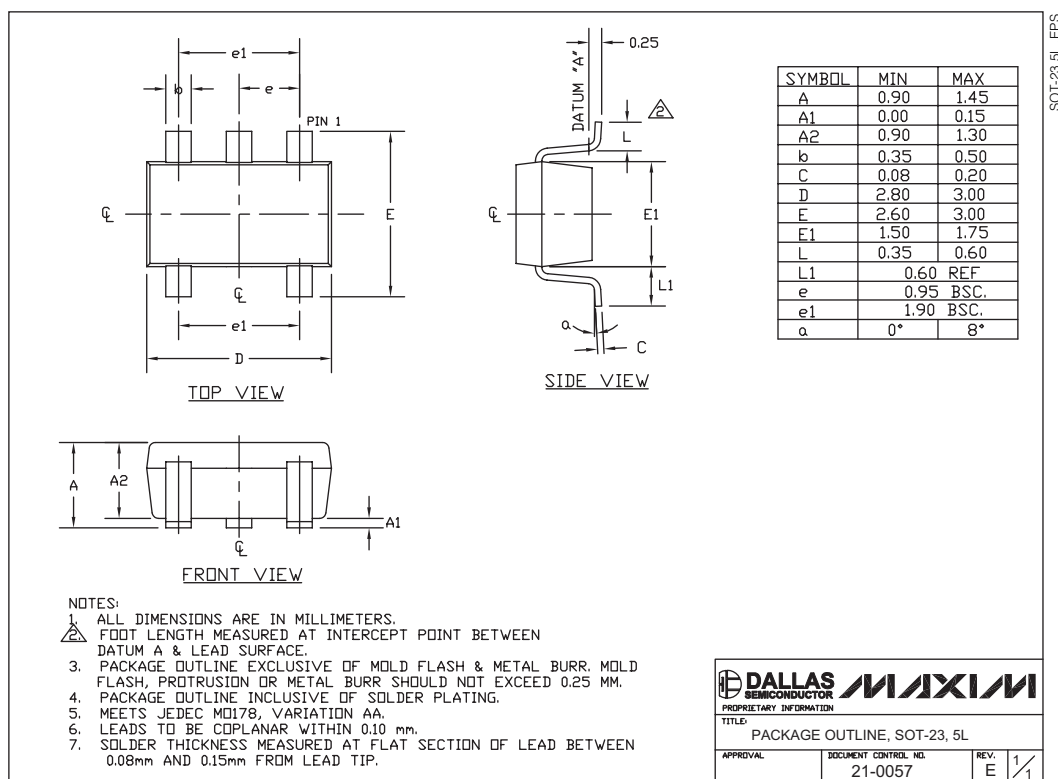

Miniature, 300MHz, Single-Supply, Rail-to-Rail Op Amps with Enable

Package Information (continued)

(The package drawing(s) in this data sheet may not reflect the most current specifications. For the latest package outline information, go to www.maxim-ic.com/packages.)

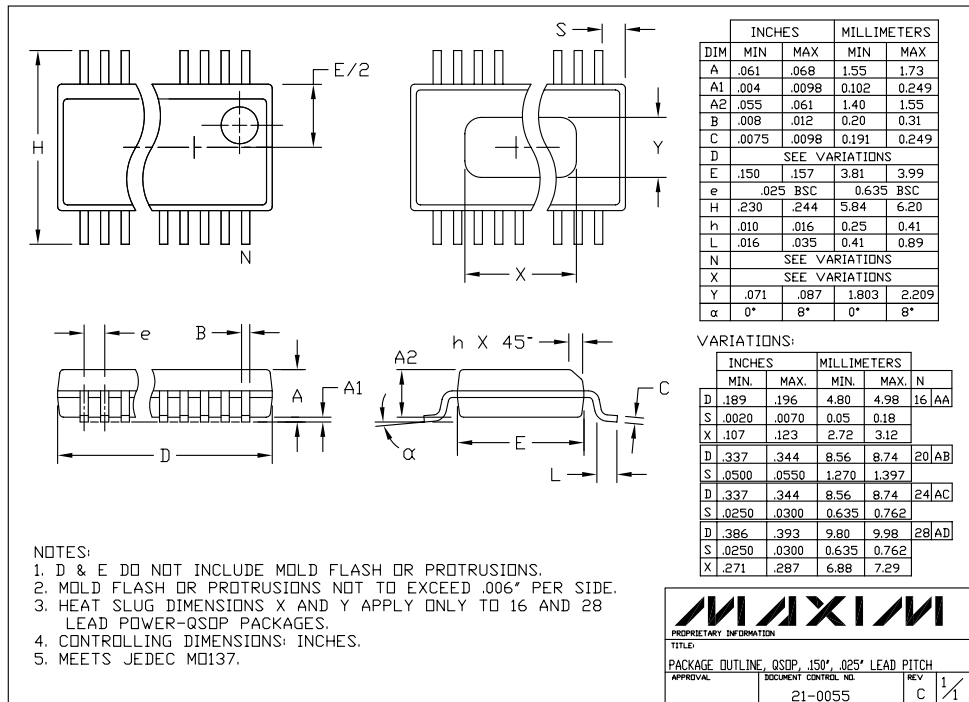
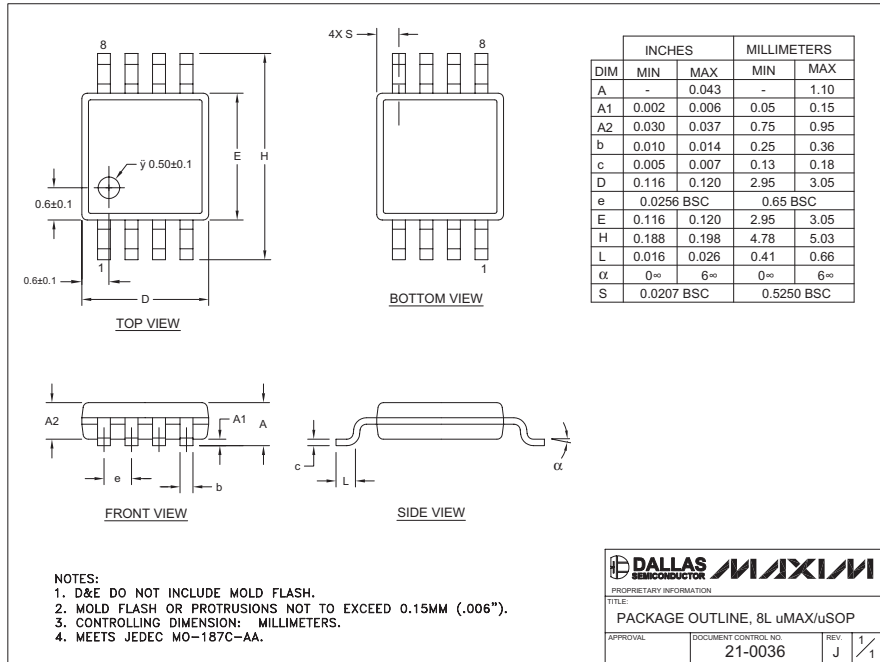

Maxim cannot assume responsibility for use of any circuitry other than circuitry entirely embodied in a Maxim product. No circuit patent licenses are implied. Maxim reserves the right to change the circuitry and specifications without notice at any time.

16 Maxim Integrated Products, 120 San Gabriel Drive, Sunnyvale, CA 94086 408-737-7600