

LM833

Low Noise, Audio Dual Operational Amplifier

The LM833 is a standard low-cost monolithic dual general-purpose operational amplifier employing Bipolar technology with innovative high-performance concepts for audio systems applications. With high frequency PNP transistors, the LM833 offers low voltage noise ($4.5 \text{ nV}/\sqrt{\text{Hz}}$), 15 MHz gain bandwidth product, 7.0 V/ μs slew rate, 0.3 mV input offset voltage with $2.0 \mu\text{V}/^\circ\text{C}$ temperature coefficient of input offset voltage. The LM833 output stage exhibits no dead-band crossover distortion, large output voltage swing, excellent phase and gain margins, low open loop high frequency output impedance and symmetrical source/sink AC frequency response.

For an improved performance dual/quad version, see the MC33079 family.

Features

- Low Voltage Noise: $4.5 \text{ nV}/\sqrt{\text{Hz}}$
- High Gain Bandwidth Product: 15 MHz
- High Slew Rate: 7.0 V/ μs
- Low Input Offset Voltage: 0.3 mV
- Low T.C. of Input Offset Voltage: $2.0 \mu\text{V}/^\circ\text{C}$
- Low Distortion: 0.002%
- Excellent Frequency Stability
- Dual Supply Operation
- Pb-Free Packages are Available

MAXIMUM RATINGS

| Rating | Symbol | Value | Unit |
|--|-----------|-------------|------------------|
| Supply Voltage (V_{CC} to V_{EE}) | V_S | +36 | V |
| Input Differential Voltage Range (Note 1) | V_{IDR} | 30 | V |
| Input Voltage Range (Note 1) | V_{IR} | ± 15 | V |
| Output Short Circuit Duration (Note 2) | t_{SC} | Indefinite | |
| Operating Ambient Temperature Range | T_A | -40 to +85 | $^\circ\text{C}$ |
| Operating Junction Temperature | T_J | +150 | $^\circ\text{C}$ |
| Storage Temperature | T_{stg} | -60 to +150 | $^\circ\text{C}$ |
| ESD Protection at any Pin – Human Body Model – Machine Model | V_{esd} | 600 200 | V |
| Maximum Power Dissipation (Notes 2 and 3) | P_D | 500 | mW |

Maximum ratings are those values beyond which device damage can occur. Maximum ratings applied to the device are individual stress limit values (not normal operating conditions) and are not valid simultaneously. If these limits are exceeded, device functional operation is not implied, damage may occur and reliability may be affected.

1. Either or both input voltages must not exceed the magnitude of V_{CC} or V_{EE} .
2. Power dissipation must be considered to ensure maximum junction temperature (T_J) is not exceeded (see power dissipation performance characteristic).
3. Maximum value at $T_A \leq 85^\circ\text{C}$.



ON Semiconductor®

<http://onsemi.com>

MARKING DIAGRAMS

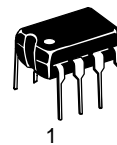

**PDIP-8
N SUFFIX
CASE 626**

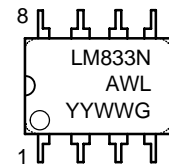

LM833N = Device Code
A = Assembly Location
WL = Wafer Lot
YY = Year
WW = Work Week
G = Pb-Free Package



**SOIC-8
D SUFFIX
CASE 751**

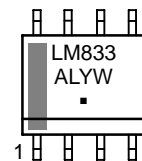

LM833 = Device Code
A = Assembly Location
L = Wafer Lot
Y = Year
W = Work Week
▪ = Pb-Free Package

PIN CONNECTIONS

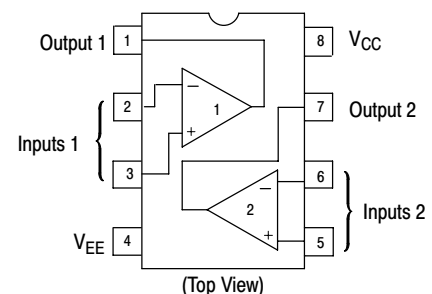

ORDERING INFORMATION

See detailed ordering and shipping information in the package dimensions section on page 6 of this data sheet.

LM833

ELECTRICAL CHARACTERISTICS ($V_{CC} = +15\text{ V}$, $V_{EE} = -15\text{ V}$, $T_A = 25^\circ\text{C}$, unless otherwise noted.)

| Characteristic | Symbol | Min | Typ | Max | Unit |
|---|--|--------------------|--------------------------------|----------------------|------------------------------|
| Input Offset Voltage ($R_S = 10\ \Omega$, $V_O = 0\text{ V}$) | V_{IO} | - | 0.3 | 5.0 | mV |
| Average Temperature Coefficient of Input Offset Voltage $R_S = 10\ \Omega$, $V_O = 0\text{ V}$, $T_A = T_{low}$ to T_{high} | $\Delta V_{IO}/\Delta T$ | - | 2.0 | - | $\mu\text{V}/^\circ\text{C}$ |
| Input Offset Current ($V_{CM} = 0\text{ V}$, $V_O = 0\text{ V}$) | I_{IO} | - | 10 | 200 | nA |
| Input Bias Current ($V_{CM} = 0\text{ V}$, $V_O = 0\text{ V}$) | I_{IB} | - | 300 | 1000 | nA |
| Common Mode Input Voltage Range | V_{ICR} | -12 | +14 -14 | +12 - | V |
| Large Signal Voltage Gain ($R_L = 2.0\text{ k}\Omega$, $V_O = \pm 10\text{ V}$) | A_{VOL} | 90 | 110 | - | dB |
| Output Voltage Swing: $R_L = 2.0\text{ k}\Omega$, $V_{ID} = 1.0\text{ V}$ $R_L = 2.0\text{ k}\Omega$, $V_{ID} = 1.0\text{ V}$ $R_L = 10\text{ k}\Omega$, $V_{ID} = 1.0\text{ V}$ $R_L = 10\text{ k}\Omega$, $V_{ID} = 1.0\text{ V}$ | V_{O+} V_{O-} V_{O+} V_{O-} | 10 - 12 - | 13.7 -14.1 13.9 -14.7 | - -10 - -12 | V |
| Common Mode Rejection ($V_{in} = \pm 12\text{ V}$) | CMR | 80 | 100 | - | dB |
| Power Supply Rejection ($V_S = 15\text{ V}$ to 5.0 V , -15 V to -5.0 V) | PSR | 80 | 115 | - | dB |
| Power Supply Current ($V_O = 0\text{ V}$, Both Amplifiers) | I_D | - | 4.0 | 8.0 | mA |

AC ELECTRICAL CHARACTERISTICS ($V_{CC} = +15\text{ V}$, $V_{EE} = -15\text{ V}$, $T_A = 25^\circ\text{C}$, unless otherwise noted.)

| Characteristic | Symbol | Min | Typ | Max | Unit |
|---|------------|-----|-------|-----|------------------------------|
| Slew Rate ($V_{in} = -10\text{ V}$ to $+10\text{ V}$, $R_L = 2.0\text{ k}\Omega$, $A_V = +1.0$) | S_R | 5.0 | 7.0 | - | $\text{V}/\mu\text{s}$ |
| Gain Bandwidth Product ($f = 100\text{ kHz}$) | GBW | 10 | 15 | - | MHz |
| Unity Gain Frequency (Open Loop) | f_U | - | 9.0 | - | MHz |
| Unity Gain Phase Margin (Open Loop) | θ_m | - | 60 | - | $^\circ$ |
| Equivalent Input Noise Voltage ($R_S = 100\ \Omega$, $f = 1.0\text{ kHz}$) | e_n | - | 4.5 | - | $\text{nV}/\sqrt{\text{Hz}}$ |
| Equivalent Input Noise Current ($f = 1.0\text{ kHz}$) | i_n | - | 0.5 | - | $\text{pA}/\sqrt{\text{Hz}}$ |
| Power Bandwidth ($V_O = 27\text{ V}_{pp}$, $R_L = 2.0\text{ k}\Omega$, $\text{THD} \leq 1.0\%$) | BWP | - | 120 | - | kHz |
| Distortion ($R_L = 2.0\text{ k}\Omega$, $f = 20\text{ Hz}$ to 20 kHz , $V_O = 3.0\text{ V}_{rms}$, $A_V = +1.0$) | THD | - | 0.002 | - | % |
| Channel Separation ($f = 20\text{ Hz}$ to 20 kHz) | C_S | - | -120 | - | dB |

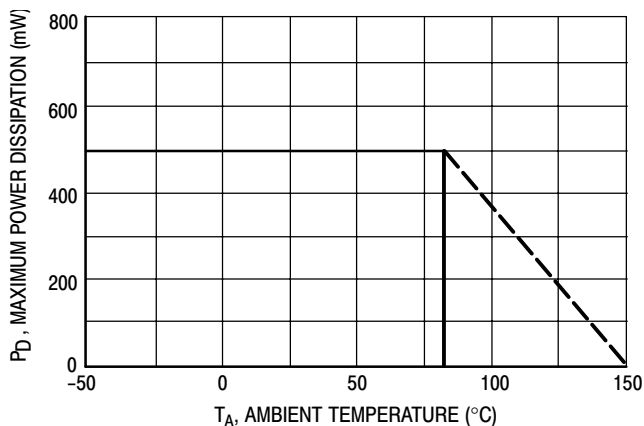

Figure 1. Maximum Power Dissipation versus Temperature

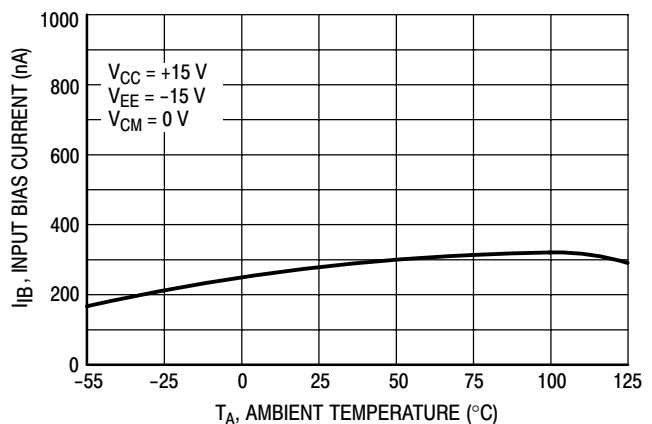

Figure 2. Input Bias Current versus Temperature

LM833

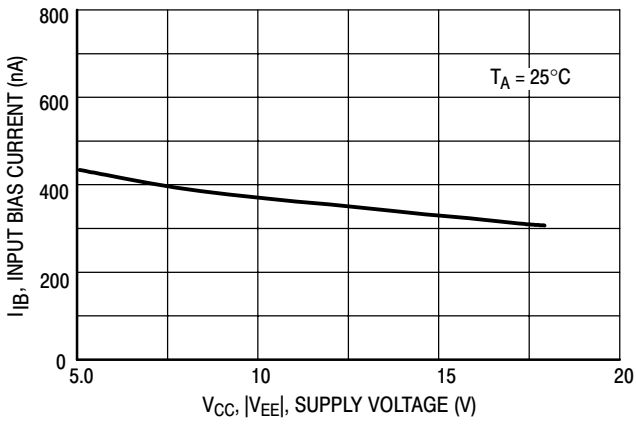

Figure 3. Input Bias Current versus Supply Voltage

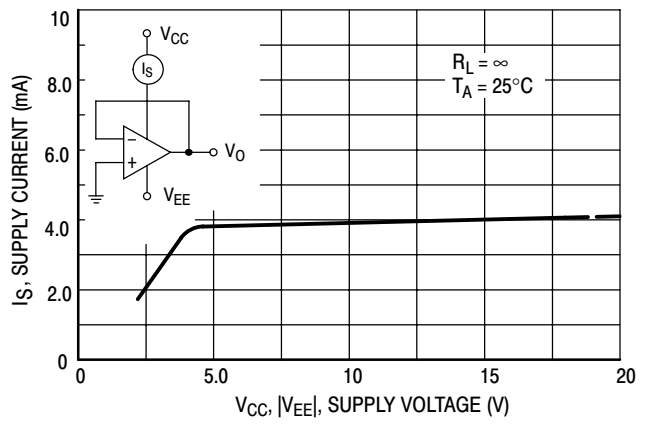

Figure 4. Supply Current versus Supply Voltage

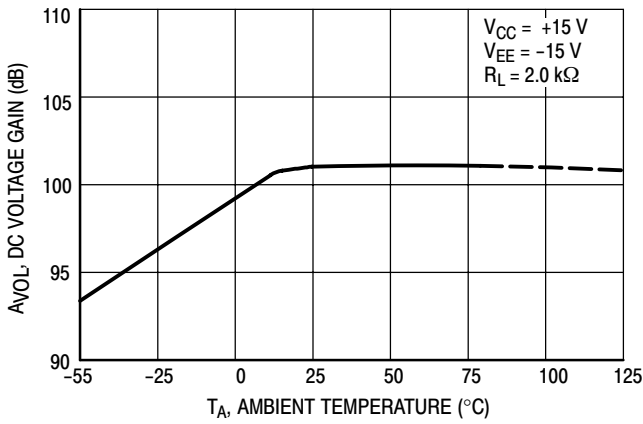

Figure 5. DC Voltage Gain versus Temperature

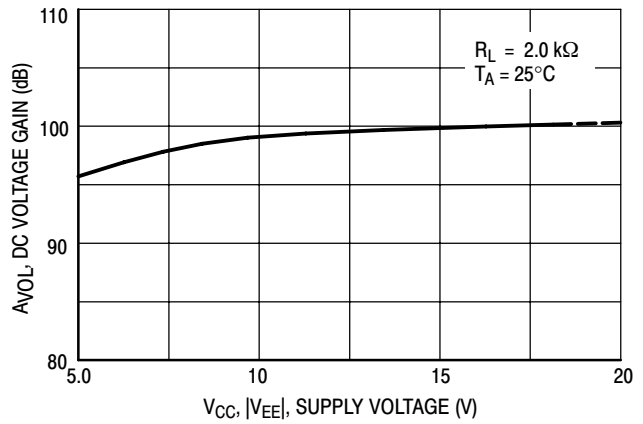

Figure 6. DC Voltage Gain versus Supply Voltage

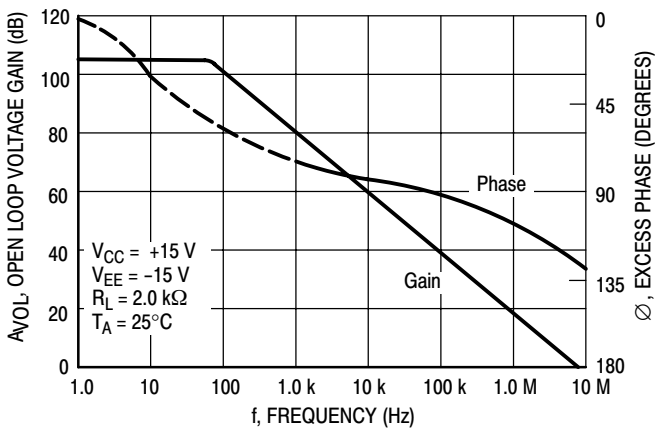

Figure 7. Open Loop Voltage Gain and Phase versus Frequency

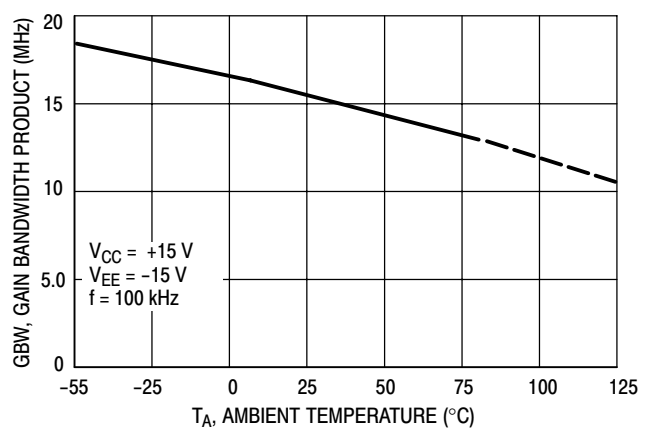

Figure 8. Gain Bandwidth Product versus Temperature

LM833

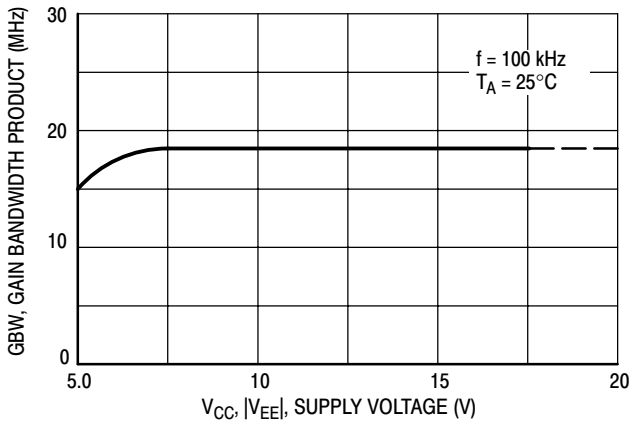

Figure 9. Gain Bandwidth Product versus Supply Voltage

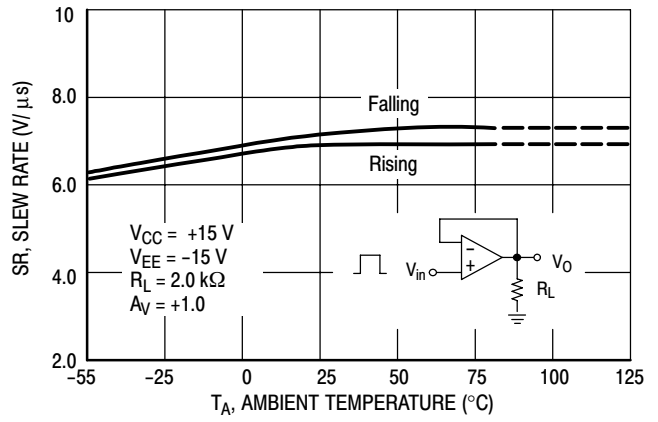

Figure 10. Slew Rate versus Temperature

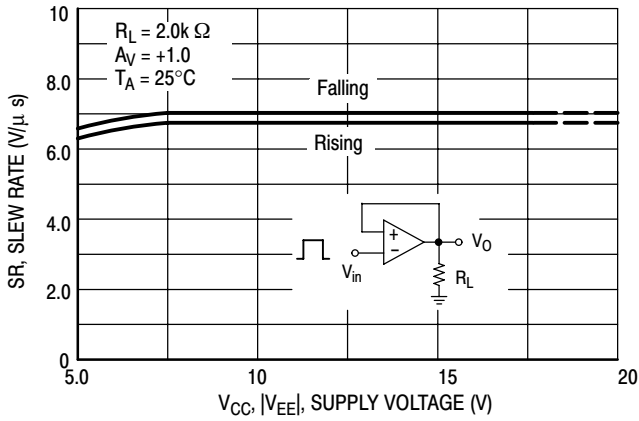

Figure 11. Slew Rate versus Supply Voltage

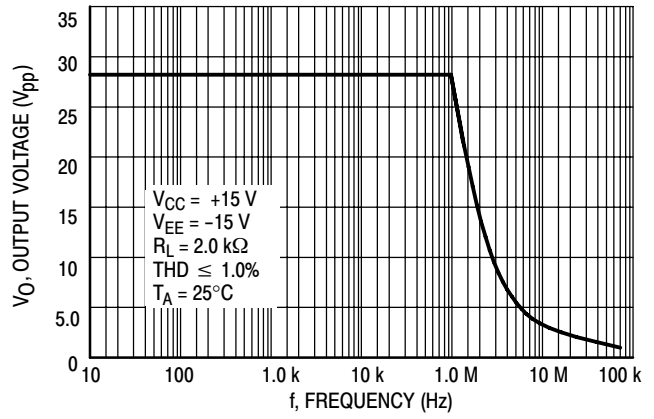

Figure 12. Output Voltage versus Frequency

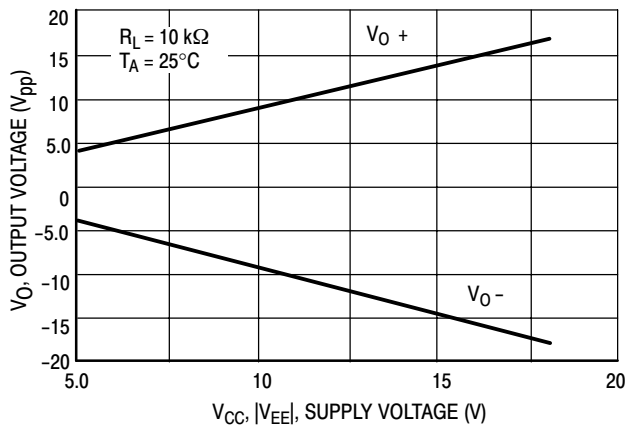

Figure 13. Maximum Output Voltage versus Supply Voltage

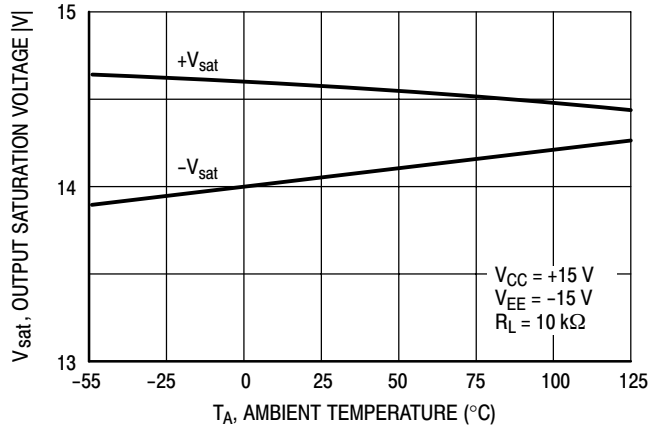

Figure 14. Output Saturation Voltage versus Temperature

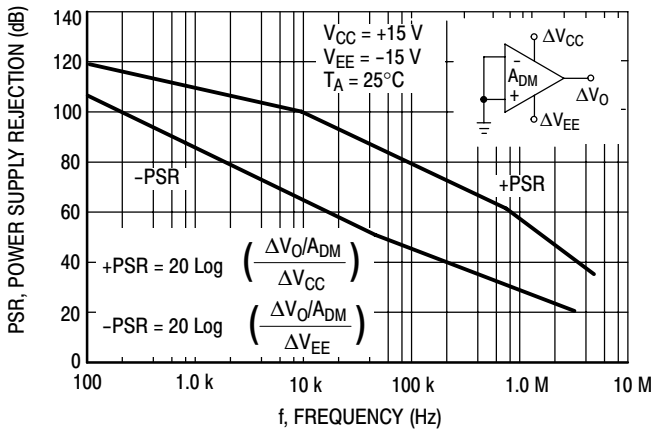

Figure 15. Power Supply Rejection versus Frequency

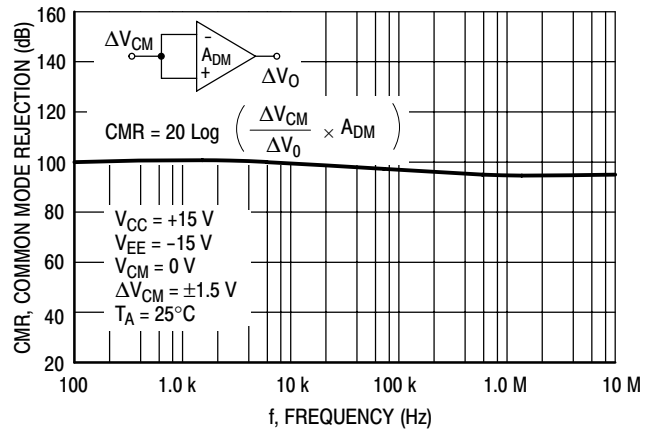

Figure 16. Common Mode Rejection versus Frequency

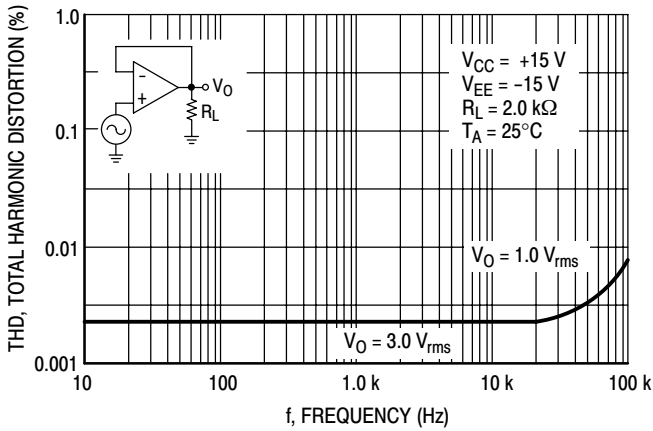

Figure 17. Total Harmonic Distortion versus Frequency

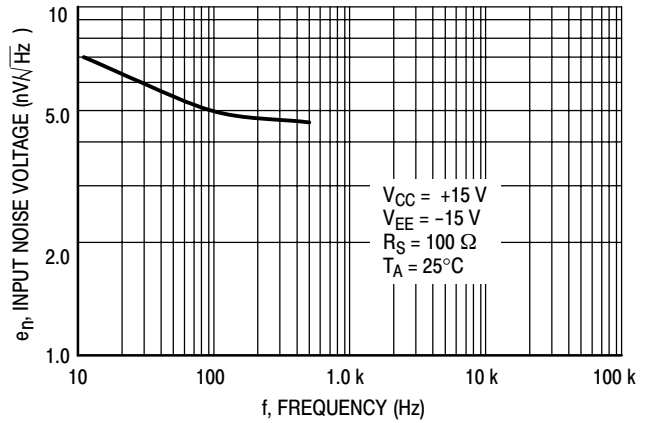

Figure 18. Input Referred Noise Voltage versus Frequency

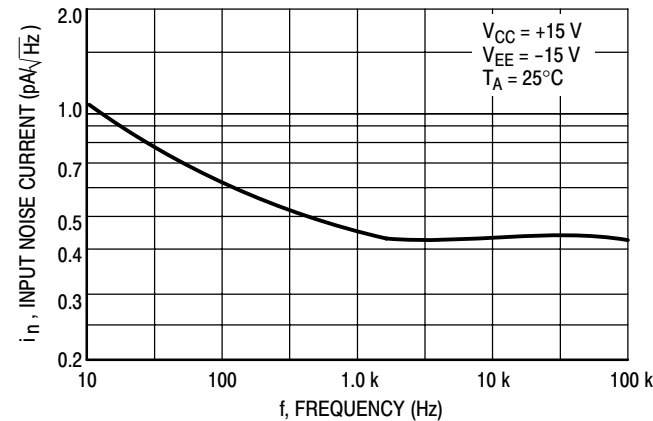

Figure 19. Input Referred Noise Current versus Frequency

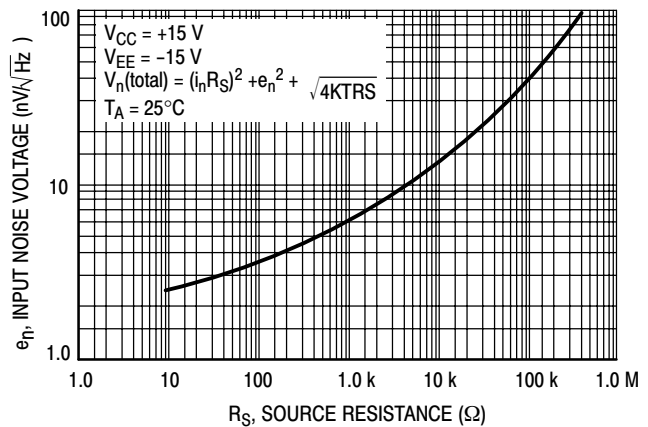

Figure 20. Input Referred Noise Voltage versus Source Resistance

LM833

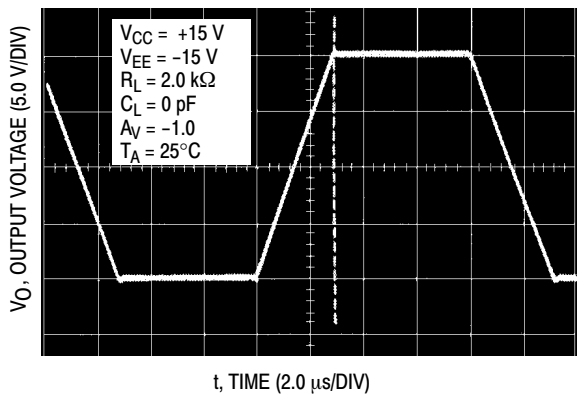

Figure 21. Inverting Amplifier

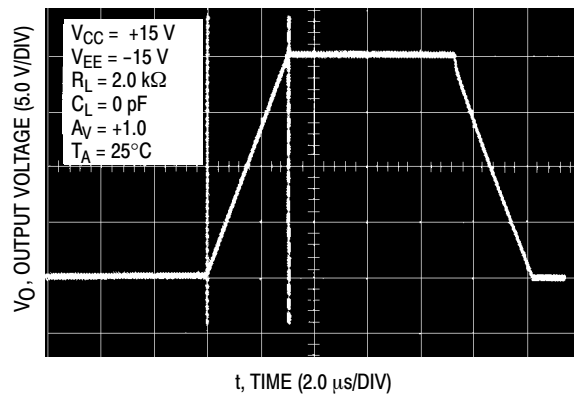

Figure 22. Noninverting Amplifier Slew Rate

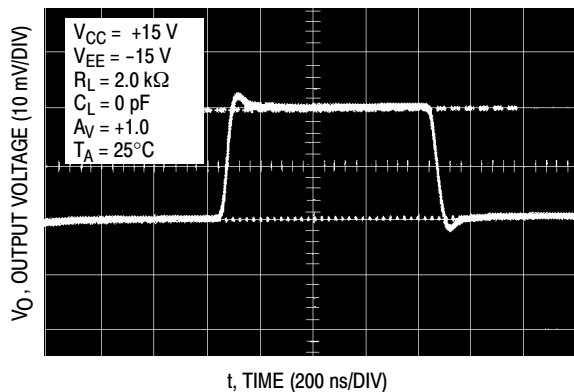

Figure 23. Noninverting Amplifier Overshoot

ORDERING INFORMATION

| Device | Package | Shipping† |
|-----------|---------------------|--------------------|
| LM833N | PDIP-8 | 50 Units / Rail |
| LM833NG | PDIP-8 (Pb-Free) | |
| LM833D | SOIC-8 | 98 Units / Rail |
| LM833DG | SOIC-8 (Pb-Free) | |
| LM833DR2 | SOIC-8 | 2500 / Tape & Reel |
| LM833DR2G | SOIC-8 (Pb-Free) | |

†For information on tape and reel specifications, including part orientation and tape sizes, please refer to our Tape and Reel Packaging Specifications Brochure, BRD8011/D.

LM833

PACKAGE DIMENSIONS

SOIC-8
D SUFFIX
CASE 751-07
ISSUE AG

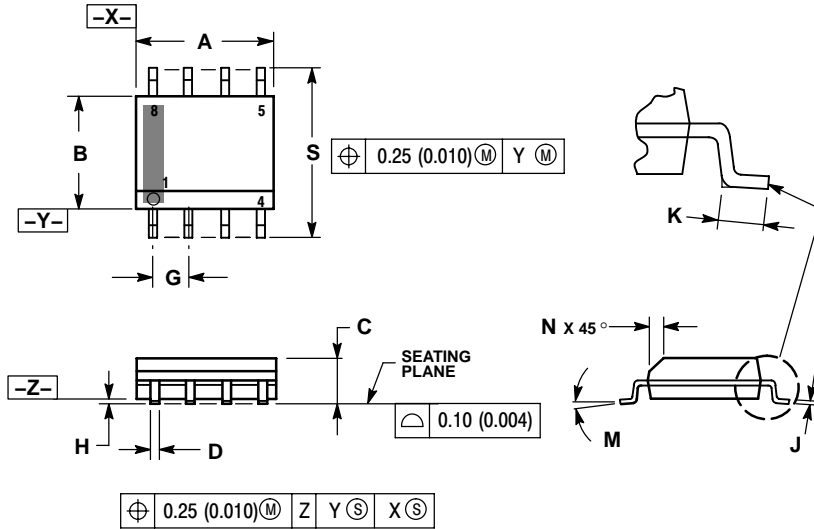

NOTES:

1. DIMENSIONING AND TOLERANCING PER ANSI Y14.5M, 1982.
2. CONTROLLING DIMENSION: MILLIMETER.
3. DIMENSION A AND B DO NOT INCLUDE MOLD PROTRUSION.
4. MAXIMUM MOLD PROTRUSION 0.15 (0.006) PER SIDE.
5. DIMENSION D DOES NOT INCLUDE DAMBAR PROTRUSION. ALLOWABLE DAMBAR PROTRUSION SHALL BE 0.127 (0.005) TOTAL IN EXCESS OF THE D DIMENSION AT MAXIMUM MATERIAL CONDITION.
6. 751-01 THRU 751-06 ARE OBSOLETE. NEW STANDARD IS 751-07.

| DIM | MILLIMETERS | | INCHES | |
|-----|-------------|------|-----------|-------|
| | MIN | MAX | MIN | MAX |
| A | 4.80 | 5.00 | 0.189 | 0.197 |
| B | 3.80 | 4.00 | 0.150 | 0.157 |
| C | 1.35 | 1.75 | 0.053 | 0.069 |
| D | 0.33 | 0.51 | 0.013 | 0.020 |
| G | 1.27 BSC | | 0.050 BSC | |
| H | 0.10 | 0.25 | 0.004 | 0.010 |
| J | 0.19 | 0.25 | 0.007 | 0.010 |
| K | 0.40 | 1.27 | 0.016 | 0.050 |
| M | 0° | 8° | 0° | 8° |
| N | 0.25 | 0.50 | 0.010 | 0.020 |
| S | 5.80 | 6.20 | 0.228 | 0.244 |

SOLDERING FOOTPRINT*

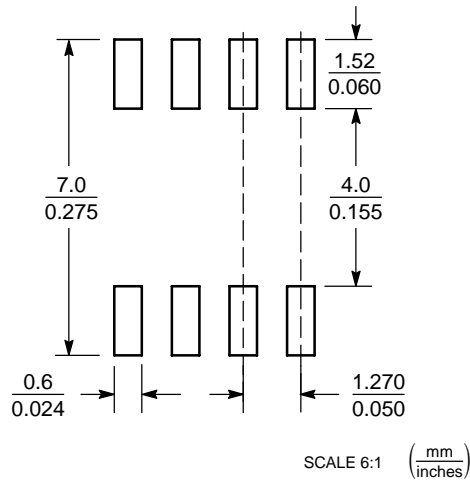

*For additional information on our Pb-Free strategy and soldering details, please download the ON Semiconductor Soldering and Mounting Techniques Reference Manual, SOL DERRM/D

LM833

PACKAGE DIMENSIONS

PDIP-8
N SUFFIX
CASE 626-05
ISSUE L

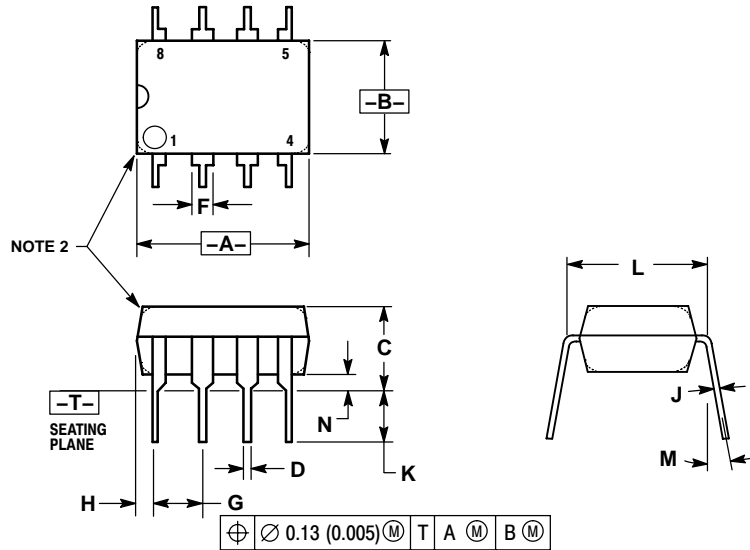

- NOTES:
1. DIMENSION L TO CENTER OF LEAD WHEN FORMED PARALLEL.
 2. PACKAGE CONTOUR OPTIONAL (ROUND OR SQUARE CORNERS).
 3. DIMENSIONING AND TOLERANCING PER ANSI Y14.5M, 1982.

| DIM | MILLIMETERS | | INCHES | |
|-----|-------------|-------|-----------|-------|
| | MIN | MAX | MIN | MAX |
| A | 9.40 | 10.16 | 0.370 | 0.400 |
| B | 6.10 | 6.60 | 0.240 | 0.260 |
| C | 3.94 | 4.45 | 0.155 | 0.175 |
| D | 0.38 | 0.51 | 0.015 | 0.020 |
| F | 1.02 | 1.78 | 0.040 | 0.070 |
| G | 2.54 BSC | | 0.100 BSC | |
| H | 0.76 | 1.27 | 0.030 | 0.050 |
| J | 0.20 | 0.30 | 0.008 | 0.012 |
| K | 2.92 | 3.43 | 0.115 | 0.135 |
| L | 7.62 BSC | | 0.300 BSC | |
| M | --- | 10° | --- | 10° |
| N | 0.76 | 1.01 | 0.030 | 0.040 |

ON Semiconductor and  are registered trademarks of Semiconductor Components Industries, LLC (SCILLC). SCILLC reserves the right to make changes without further notice to any products herein. SCILLC makes no warranty, representation or guarantee regarding the suitability of its products for any particular purpose, nor does SCILLC assume any liability arising out of the application or use of any product or circuit, and specifically disclaims any and all liability, including without limitation special, consequential or incidental damages. "Typical" parameters which may be provided in SCILLC data sheets and/or specifications can and do vary in different applications and actual performance may vary over time. All operating parameters, including "Typicals" must be validated for each customer application by customer's technical experts. SCILLC does not convey any license under its patent rights nor the rights of others. SCILLC products are not designed, intended, or authorized for use as components in systems intended for surgical implant into the body, or other applications intended to support or sustain life, or for any other application in which the failure of the SCILLC product could create a situation where personal injury or death may occur. Should Buyer purchase or use SCILLC products for any such unintended or unauthorized application, Buyer shall indemnify and hold SCILLC and its officers, employees, subsidiaries, affiliates, and distributors harmless against all claims, costs, damages, and expenses, and reasonable attorney fees arising out of, directly or indirectly, any claim of personal injury or death associated with such unintended or unauthorized use, even if such claim alleges that SCILLC was negligent regarding the design or manufacture of the part. SCILLC is an Equal Opportunity/Affirmative Action Employer. This literature is subject to all applicable copyright laws and is not for resale in any manner.

PUBLICATION ORDERING INFORMATION

LITERATURE FULFILLMENT:
Literature Distribution Center for ON Semiconductor
P.O. Box 61312, Phoenix, Arizona 85082-1312 USA
Phone: 480-829-7710 or 800-344-3860 Toll Free USA/Canada
Fax: 480-829-7709 or 800-344-3867 Toll Free USA/Canada
Email: orderlit@onsemi.com

N. American Technical Support: 800-282-9855 Toll Free
USA/Canada

Japan: ON Semiconductor, Japan Customer Focus Center
2-9-1 Kamimeguro, Meguro-ku, Tokyo, Japan 153-0051
Phone: 81-3-5773-3850

ON Semiconductor Website: <http://onsemi.com>

Order Literature: <http://www.onsemi.com/litorder>

For additional information, please contact your local Sales Representative.

LM833/D