



# Low-Cost, High-Slew-Rate, Rail-to-Rail I/O Op Amps in SC70

## General Description

The MAX4490/MAX4491/MAX4492 single/dual/quad, low-cost CMOS op amps feature Rail-to-Rail® input and output capability from either a single 2.7V to 5.5V supply or dual  $\pm 1.35V$  to  $\pm 2.75V$  supplies. These amplifiers exhibit a high slew rate of  $10V/\mu s$  and a gain-bandwidth product of 10MHz. They can drive  $2k\Omega$  resistive loads to within 55mV of either supply rail and remain unity-gain stable with capacitive loads up to 300pF.

The MAX4490 is offered in the ultra-small, 5-pin SC70 package, which is 50% smaller than the standard 5-pin SOT23 package. Specifications for all parts are guaranteed over the automotive ( $-40^{\circ}C$  to  $+125^{\circ}C$ ) temperature range.

## Applications

Battery-Powered Instruments  
 Portable Equipment  
 Audio Signal Conditioning  
 Low-Power/Low-Voltage Applications  
 Sensor Amplifiers  
 RF Power Amplifier Control  
 High-Side/Low-Side Current Sensors

## Capacitive-Load Stability

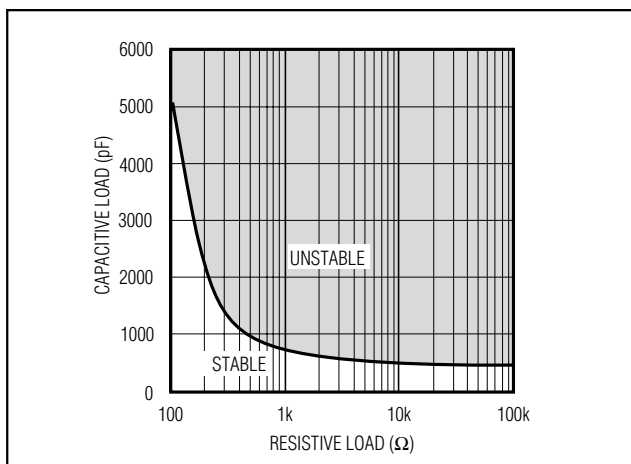

Rail-to-Rail is a registered trademark of Nippon Motorola, Ltd.



Maxim Integrated Products 1

**For pricing, delivery, and ordering information, please contact Maxim/Dallas Direct! at 1-888-629-4642, or visit Maxim's website at [www.maxim-ic.com](http://www.maxim-ic.com).**

## Features

- ◆ 2.7V to 5.5V Single-Supply Operation
- ◆  $10V/\mu s$  Slew Rate
- ◆ Rail-to-Rail Input Common-Mode Voltage Range
- ◆ Rail-to-Rail Output Voltage Swing
- ◆ 10MHz Gain-Bandwidth Product
- ◆ Unity-Gain Stable with Capacitive Loads Up to 300pF
- ◆ 50pA Input Bias Current
- ◆ Ultra-Small, 5-Pin SC70 Package (MAX4490)

## Ordering Information

PART	TEMP RANGE	PIN-PACKAGE	TOP MARK
MAX4490AXK-T	$-40^{\circ}C$ to $+125^{\circ}C$	5 SC70-5	AAB
MAX4490AUK-T	$-40^{\circ}C$ to $+125^{\circ}C$	5 SOT23-5	ADKQ
MAX4491AKA-T	$-40^{\circ}C$ to $+125^{\circ}C$	8 SOT23-5	AADB
MAX4491AUA	$-40^{\circ}C$ to $+125^{\circ}C$	8 $\mu$ MAX	—
MAX4492AUD	$-40^{\circ}C$ to $+125^{\circ}C$	14 TSSOP	—
MAX4492ASD	$-40^{\circ}C$ to $+125^{\circ}C$	14 SO	—

## Pin Configurations/ Functional Diagrams

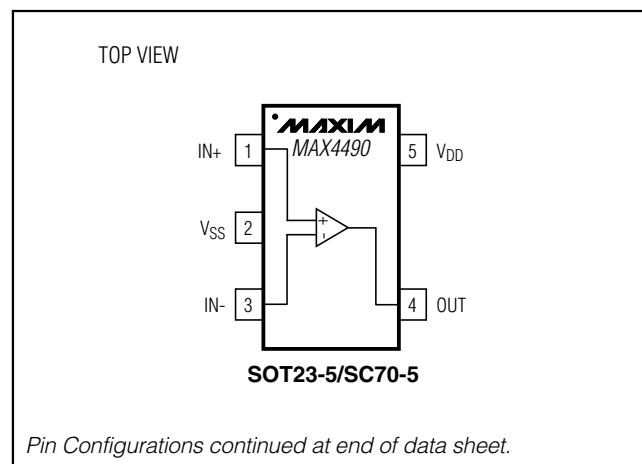

MAX4490/MAX4491/MAX4492

# Low-Cost, High-Slew-Rate, Rail-to-Rail I/O Op Amps in SC70

## ABSOLUTE MAXIMUM RATINGS

Supply Voltage ( $V_{DD}$ to $V_{SS}$ ).....6V	8-Pin $\mu$ MAX (derate 4.1mW/°C above +70°C)..... 330mW
All Other Pins .....( $V_{SS} - 0.3V$ ) to ( $V_{DD} + 0.3V$ )	14-Pin TSSOP (derate 8.3mW/°C above +70°C) ..... 667mW
Output Short-Circuit Duration .....10s	14-Pin SO (derate 8.3mW/°C above +70°C)..... 667mW
Continuous Power Dissipation ( $T_A = +70^\circ\text{C}$ )	Operating Temperature Range ..... -40°C to +125°C
5-Pin SC70 (derate 2.5mW/°C above +70°C)..... 200mW	Junction Temperature ..... +150°C
5-Pin SOT23 (derate 7.1mW/°C above +70°C)..... 571mW	Storage Temperature Range ..... -65°C to +150°C
8-Pin SOT23 (derate 5.26mW/°C above +70°C).....421 mW	Lead Temperature (soldering, 10s) ..... +300°C

Stresses beyond those listed under "Absolute Maximum Ratings" may cause permanent damage to the device. These are stress ratings only, and functional operation of the device at these or any other conditions beyond those indicated in the operational sections of the specifications is not implied. Exposure to absolute maximum rating conditions for extended periods may affect device reliability.

## ELECTRICAL CHARACTERISTICS

( $V_{DD} = 5V$ ,  $V_{SS} = 0$ ,  $V_{CM} = 0$ ,  $V_{OUT} = V_{DD}/2$ ,  $R_L = 100k\Omega$  connected to  $V_{DD}/2$ ,  $T_A = T_{MIN}$  to  $T_{MAX}$ , unless otherwise noted. Typical values are at  $T_A = +25^\circ\text{C}$ .) (Note 1)

PARAMETER	SYMBOL	CONDITIONS	MIN	TYP	MAX	UNITS
Supply Voltage Range	$V_{DD}$	(Note 2)	2.7		5.5	V
Supply Current (per amplifier)	$I_S$			0.8	2	mA
Input Offset Voltage	$V_{OS}$	(Note 3)	$T_A = +25^\circ\text{C}$		±10	mV
			$T_A = T_{MIN}$ to $T_{MAX}$			
Input Bias Current	$I_B$	(Note 3)		±0.05	±2.5	nA
Input Offset Current	$I_{OS}$	(Note 3)		±0.05	±2.5	nA
Input Resistance	$R_{IN}$			1000		M $\Omega$
Input Common-Mode Range	$V_{CM}$	Inferred from CMRR test	$V_{SS}$		$V_{DD}$	V
Common-Mode Rejection Ratio	CMRR	$V_{SS} \leq V_{CM} \leq V_{DD}$	54	75		dB
Power-Supply Rejection Ratio	PSRR	$2.7V \leq V_{DD} \leq 5.5V$	65	100		dB
Large-Signal Voltage Gain	$A_V$	$(V_{SS} + 0.25V) \leq V_{OUT} \leq (V_{DD} - 0.25V)$	$R_L = 100k\Omega$		110	dB
			$R_L = 2k\Omega$			
Output-Voltage Swing High	$V_{OH}$	Specified as $V_{DD} - V_{OH}$	$R_L = 100k\Omega$		1.5	mV
			$R_L = 2k\Omega$			
Output-Voltage Swing Low	$V_{OL}$	Specified as $V_{OL} - V_{SS}$	$R_L = 100k\Omega$		1.5	mV
			$R_L = 2k\Omega$			
Output Short-Circuit Current	$I_{OUT(SC)}$	Sourcing or sinking		±50		mA
Gain-Bandwidth Product	GBWP	$C_L = 10pF$		10		MHz
Input Capacitance	$C_{IN}$			5		pF
Phase Margin		$C_L = 10pF$		60		degrees
Gain Margin		$C_L = 10pF$		10		dB
Slew Rate	SR	Measured from 10% to 90% of 4V <sub>P-P</sub> step		10		V/ $\mu$ s
Voltage-Noise Density	$e_n$	$f = 10kHz$		12		nV/ $\sqrt{Hz}$
Current-Noise Density	$i_n$	$f = 10kHz$		1		fA/ $\sqrt{Hz}$
Capacitive-Load Drive		$A_V(CL) = 1$ , no sustained oscillations		300		pF

**Note 1:** All units production tested at  $T_A = +25^\circ\text{C}$ . Limits over temperature guaranteed by design.

**Note 2:** Guaranteed by the Power-Supply Rejection Ratio (PSRR) test.

**Note 3:** Input Offset Voltage, Input Bias Current, and Input Offset Current are all tested and guaranteed at both ends of the common-mode range.

# Low-Cost, High-Slew-Rate, Rail-to-Rail I/O Op Amps in SC70

## Typical Operating Characteristics

( $V_{DD} = 5V$ ,  $V_{SS} = 0$ ,  $V_{CM} = V_{DD}/2$ ,  $R_L = 100k\Omega$  to  $V_{DD}/2$ ,  $T_A = +25^\circ C$ , unless otherwise noted.)

MAX4490/MAX4491/MAX4492

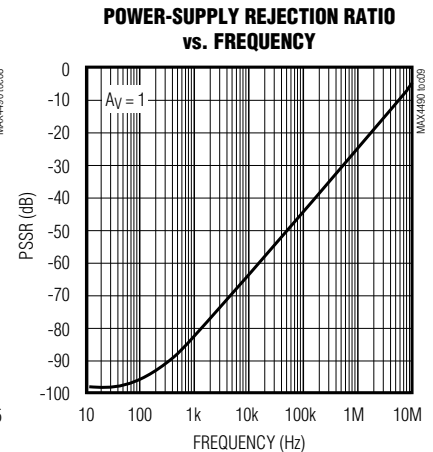
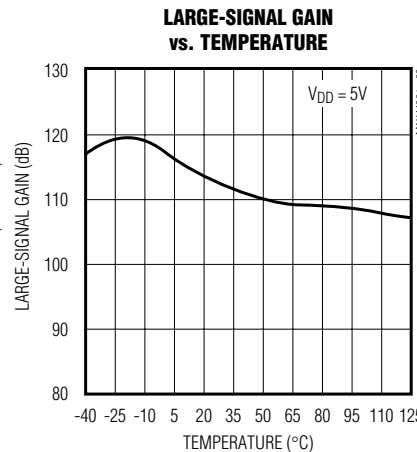
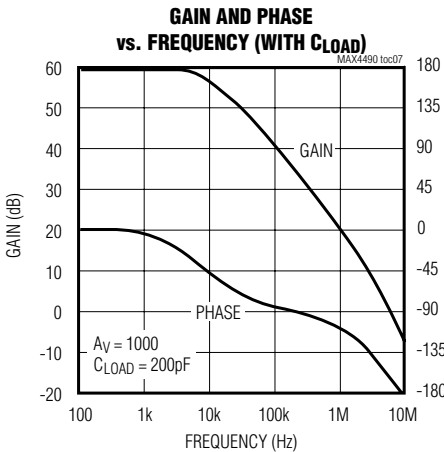
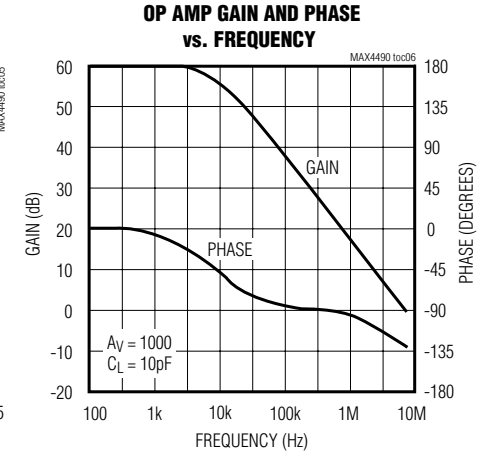
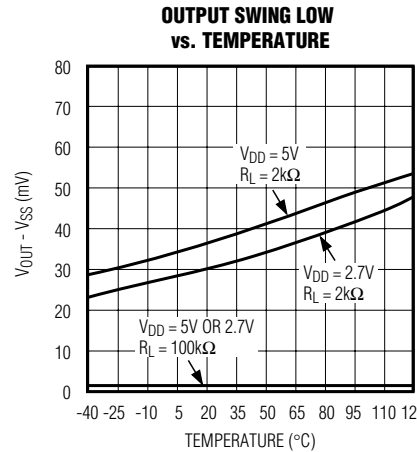
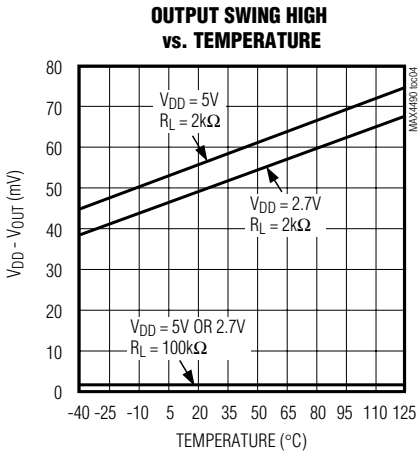
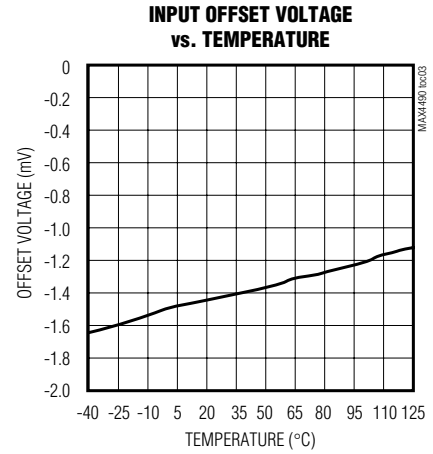
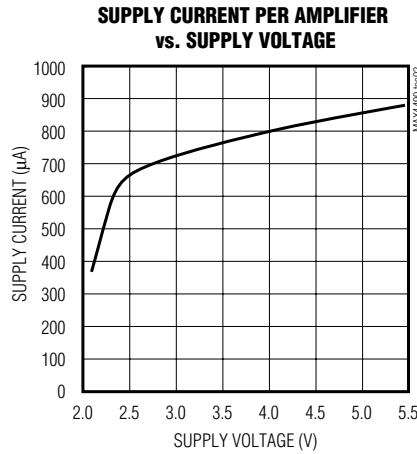
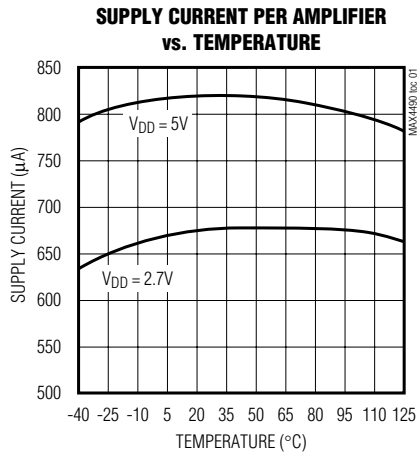

# Low-Cost, High-Slew-Rate, Rail-to-Rail I/O Op Amps in SC70

## Typical Operating Characteristics (continued)

( $V_{DD} = 5V$ ,  $V_{SS} = 0$ ,  $V_{CM} = V_{DD}/2$ ,  $R_L = 100k\Omega$  to  $V_{DD}/2$ ,  $T_A = +25^\circ C$ , unless otherwise noted.)

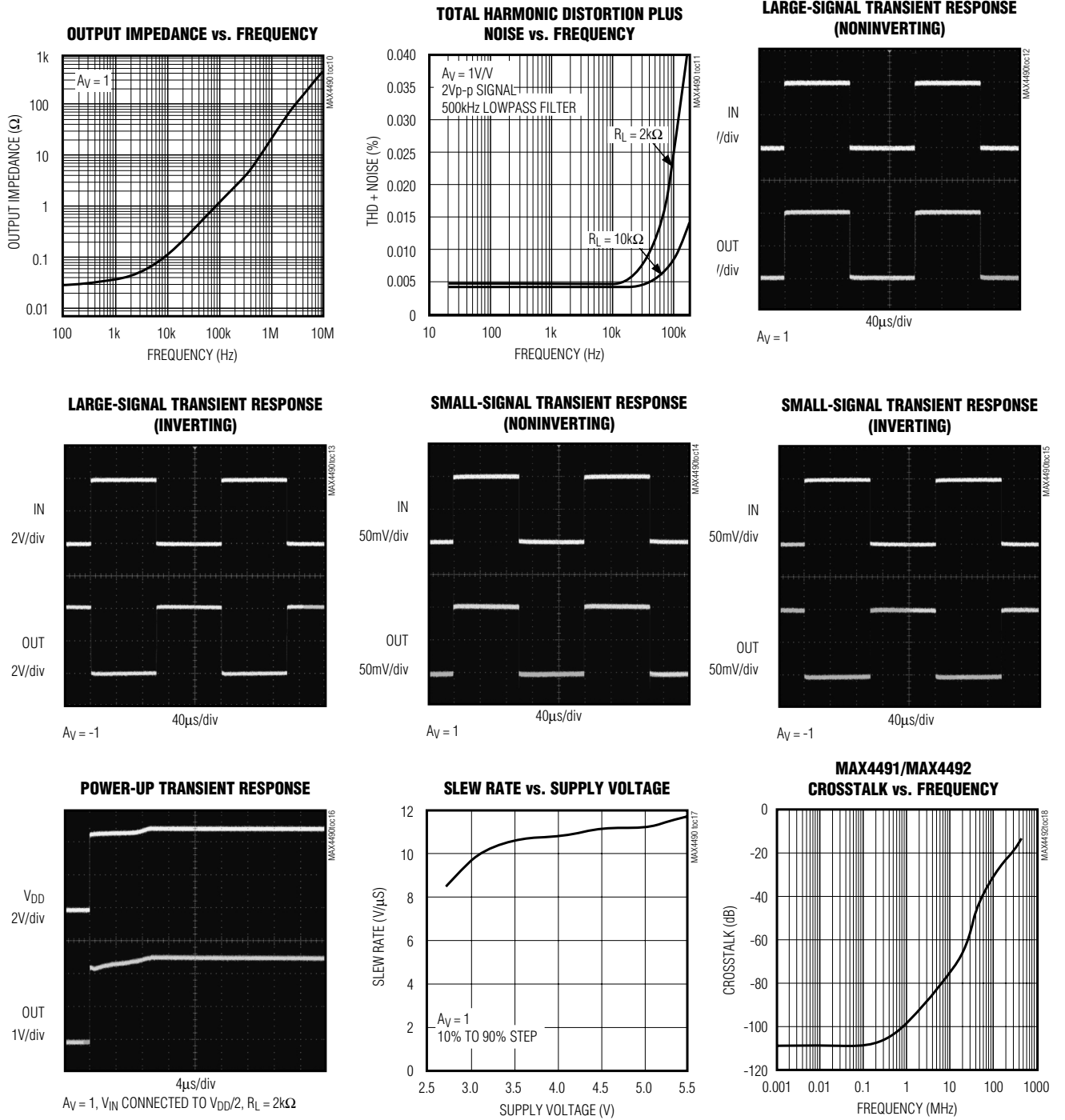

# Low-Cost, High-Slew-Rate, Rail-to-Rail I/O Op Amps in SC70

## Pin Description

MAX4490/MAX4491/MAX4492

PIN			NAME	FUNCTION
MAX4490	MAX4491	MAX4492		
1	—	—	IN+	Noninverting Input
2	4	11	V <sub>SS</sub>	Negative Supply Input. Connect to ground for single-supply operation.
3	—	—	IN-	Inverting Input
4	—	—	OUT	Amplifier Output
5	8	4	V <sub>DD</sub>	Positive Supply Input
—	3	3	INA+	Noninverting Input to Amplifier A
—	2	2	INA-	Inverting Input to Amplifier A
—	1	1	OUTA	Amplifier A Output
—	5	5	INB+	Noninverting Input to Amplifier B
—	6	6	INB-	Inverting Input to Amplifier B
—	7	7	OUTB	Amplifier B Output
—	—	10, 12	INC+, IND+	Noninverting Inputs to Amplifiers C and D
—	—	9, 13	INC-, IND-	Inverting Inputs to Amplifiers C and D
—	—	8, 14	OUTC, OUTD	Amplifiers C and D Outputs

## Detailed Description

### Rail-to-Rail Input Stage

The MAX4490/MAX4491/MAX4492 CMOS operational amplifiers have parallel-connected N- and P-channel differential input stages that combine to accept a common-mode range extending to both supply rails. The N-channel stage is active for common-mode input voltages typically greater than (V<sub>SS</sub> + 1.2V), and the P-channel stage is active for common-mode input voltages typically less than (V<sub>DD</sub> - 1.2V).

### Rail-to-Rail Output Stage

The MAX4490/MAX4491/MAX4492 CMOS operational amplifiers feature class-AB push-pull output stages that can drive a 100kΩ load to within 1.5mV of either supply rail. Short-circuit output current is typically ±50mA.

Figures 1a and 1b show the typical temperature dependence of output source and sink currents, respectively, for three fixed values of (V<sub>DD</sub> - V<sub>OH</sub>) and (V<sub>OL</sub> - V<sub>SS</sub>). For example, at V<sub>DD</sub> = 5.0V, the load currents that maintain (V<sub>DD</sub> - V<sub>OH</sub>) = 100mV and (V<sub>OL</sub> - V<sub>SS</sub>) = 100mV at T<sub>A</sub> = +25°C are 2.2mA and 3.3mA, respectively, when

the load is connected to V<sub>DD</sub>/2. Consistent resistive-drive capability is (2.5 - 0.1) / 2.2 = 1.1kΩ. For the same application, resistive-drive capability is 2.2kΩ when the load is connected to V<sub>DD</sub> or V<sub>SS</sub>.

## Applications Information

### Power-Supply Considerations

The MAX4490/MAX4491/MAX4492 operate from a single 2.7V to 5.5V supply or from dual ±1.35V to ±2.75V supplies with typically 800μA supply current per amplifier. A high power-supply rejection ratio of 100dB allows for extended operation from a decaying battery voltage, thereby simplifying designs for portable applications. For single-supply operation, bypass the power supply with a 0.1μF ceramic capacitor placed close to the V<sub>DD</sub> pin. For dual-supply operation, bypass each supply to ground.

### Input Capacitance

One consequence of the parallel-connected differential input stages for rail-to-rail operation is a relatively large input capacitance C<sub>IN</sub> (typically 5pF). This introduces a

# Low-Cost, High-Slew-Rate, Rail-to-Rail I/O Op Amps in SC70

pole at frequency  $(2\pi R' C_{IN})^{-1}$ , where  $R'$  is the parallel combination of the gain-setting resistors for the inverting or noninverting amplifier configuration (Figure 2). If the pole frequency is less than or comparable to the unity-gain bandwidth (10MHz), the phase margin will be reduced, and the amplifier will exhibit degraded AC performance through either ringing in the step response or sustained oscillations. The pole frequency is 10MHz when  $R' = 3.2k\Omega$ . To maximize stability,  $R' < 3k\Omega$  is recommended.

Applications that require rail-to-rail operation with minimal loading (for small  $V_{DD} - V_{OH}$  and  $V_{OL} - V_{SS}$ ) will typically require  $R'$  values  $> 3k\Omega$ . To improve step response under these conditions, connect a small

capacitor  $C_f$  between the inverting input and output. Choose  $C_f$  as follows:

$$C_f = 5(R / R_f) \text{ [pF]}$$

where  $R_f$  is the feedback resistor and  $R$  is the gain-setting resistor (Figure 2).

Figure 3 shows the step response for a noninverting amplifier subject to  $R' = 4k\Omega$  with and without the  $C_f$  feedback capacitor.

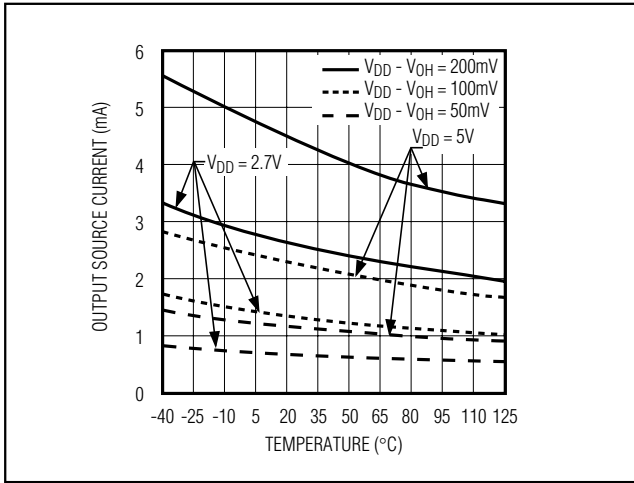

Figure 1a. Output Source Current vs. Temperature

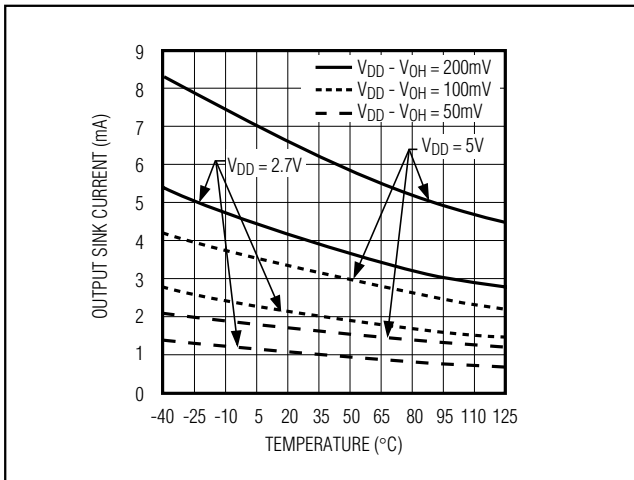

Figure 1b. Output Sink Current vs. Temperature

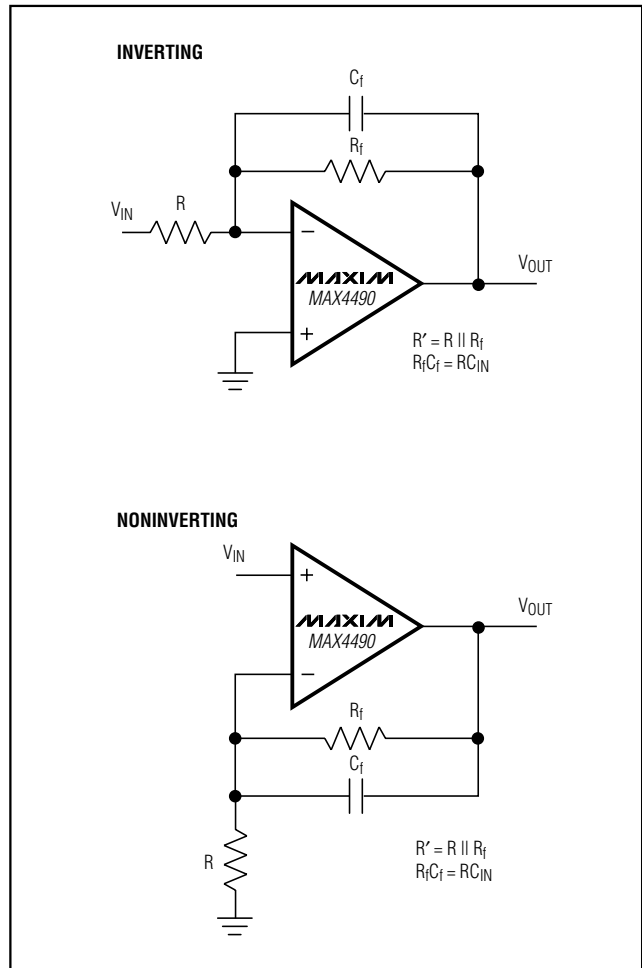

Figure 2. Inverting and Noninverting Amplifier with Feedback Compensation

# Low-Cost, High-Slew-Rate, Rail-to-Rail I/O Op Amps in SC70

MAX4490/MAX4491/MAX4492

## Driving Capacitive Loads

In conjunction with op amp output resistance, capacitive loads introduce a pole frequency that can reduce phase margin and lead to unstable operation. The MAX4490/MAX4491/MAX4492 drive capacitive loads up to 300pF without significant degradation of step response and slew rate (Figure 4). *Capacitive-Load Stability* (page 1) shows regions of stable and marginally stable (step overshoot <10%) operation for different combinations of capacitive and resistive loads.

Improve stability for large capacitive loads by adding an isolation resistor (typically 10Ω) in series with the output (Figure 5). Note that the isolation resistor forms a voltage divider with potential for gain error.

## Chip Information

MAX4490 TRANSISTOR COUNT: 60  
 MAX4491 TRANSISTOR COUNT: 120  
 MAX4492 TRANSISTOR COUNT: 240  
 SUBSTRATE CONNECTED TO V<sub>SS</sub>

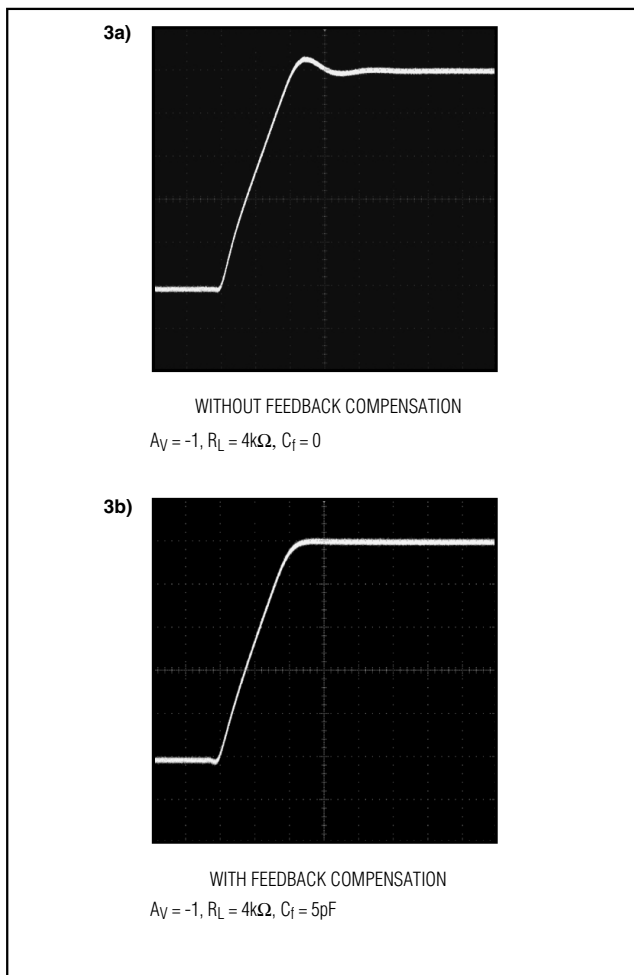

Figure 3. Step Response With and Without Feedback Compensation

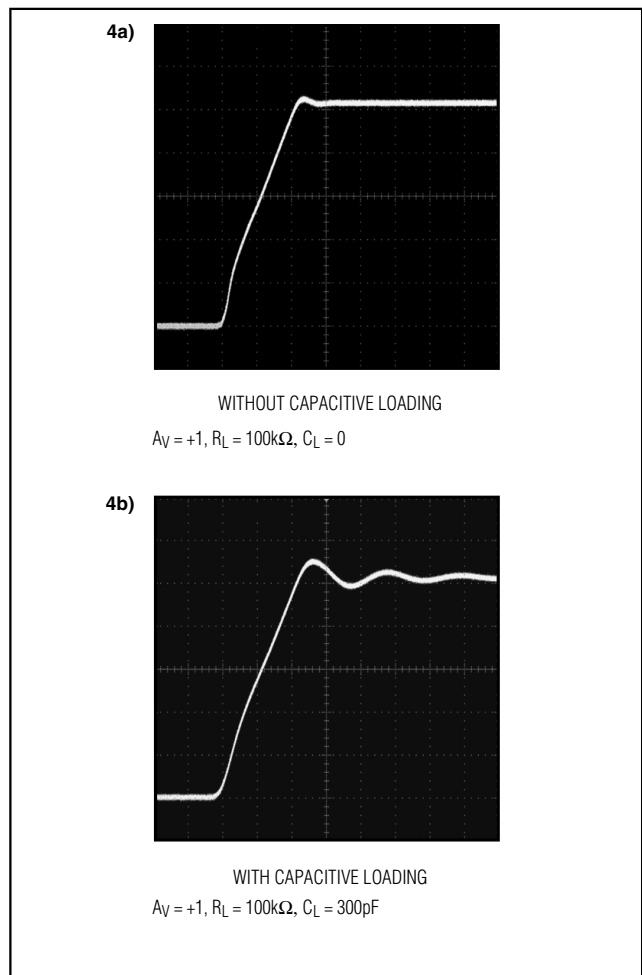

Figure 4. Step Response With and Without Capacitive Loading

# Low-Cost, High-Slew-Rate, Rail-to-Rail I/O Op Amps in SC70

## Pin Configurations/ Functional Diagrams (continued)

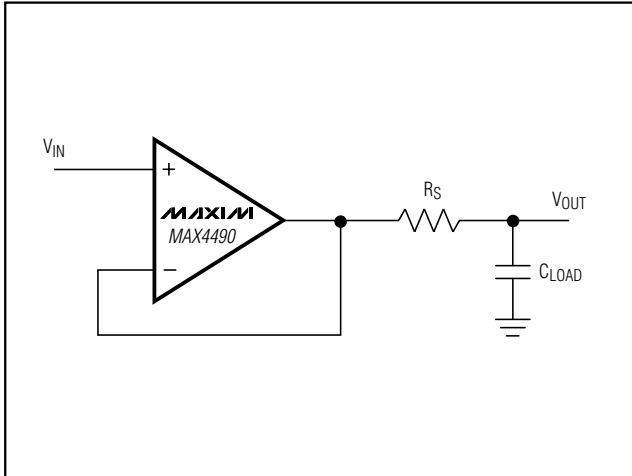
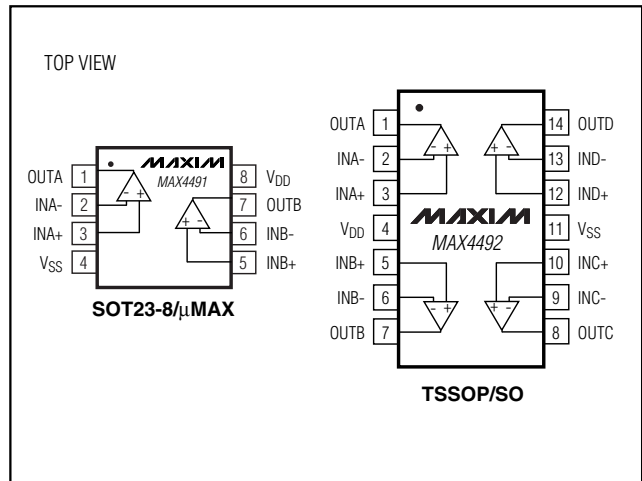

Figure 5. Isolation Resistor for Large Capacitive Loads



## Package Information

SYMBOL	MIN	MAX
e	0.65	BSC
D	1.80	2.20
b	0.15	0.30
E	1.15	1.35
HE	1.80	2.40
Q1	0.10	0.40
A2	0.80	1.00
A1	0.00	0.10
A	0.80	1.10
c	0.10	0.18
L	0.10	0.30
L1	0.425	TYP.

SC70\_5L.EPS

NOTE:  
 1. ALL DIMENSIONS ARE IN MILLIMETERS  
 2. DIMENSIONS ARE INCLUSIVE OF PLATING  
 3. DIMENSIONS ARE EXCLUSIVE OF MOLD FLASH & METAL BURR  
 4. ALL SPECIFICATIONS COMPLY TO EIAJ SC70  
 5. COPLANARITY 4 MILS. MAX.

<b>MAXIM</b>			
PROPRIETARY INFORMATION			
TITLE: PACKAGE OUTLINE, SC70, 5L			
APPROVAL	DOCUMENT CONTROL NO. 21-0076	REV. B	1/1

Maxim cannot assume responsibility for use of any circuitry other than circuitry entirely embodied in a Maxim product. No circuit patent licenses are implied. Maxim reserves the right to change the circuitry and specifications without notice at any time.

8 Maxim Integrated Products, 120 San Gabriel Drive, Sunnyvale, CA 94086 408-737-7600