



# LS404

## HIGH PERFORMANCE QUAD OPERATIONAL AMPLIFIER

- SINGLE OR SPLIT SUPPLY OPERATION
- LOW POWER CONSUMPTION
- SHORT CIRCUIT PROTECTION
- LOW DISTORTION, LOW NOISE
- HIGH GAIN-BANDWIDTH PRODUCT
- HIGH CHANNEL SEPARATION

### DESCRIPTION

The LS404 is a high performance quad operational amplifier with frequency and phase compensation built into the chip. The internal phase compensation allows stable operation as voltage follower in spite of its high Gain-Bandwidth Product.

The circuit presents very stable electrical characteristics over the entire supply voltage range, and is particularly intended for professional and telecom applications (active filter, etc).

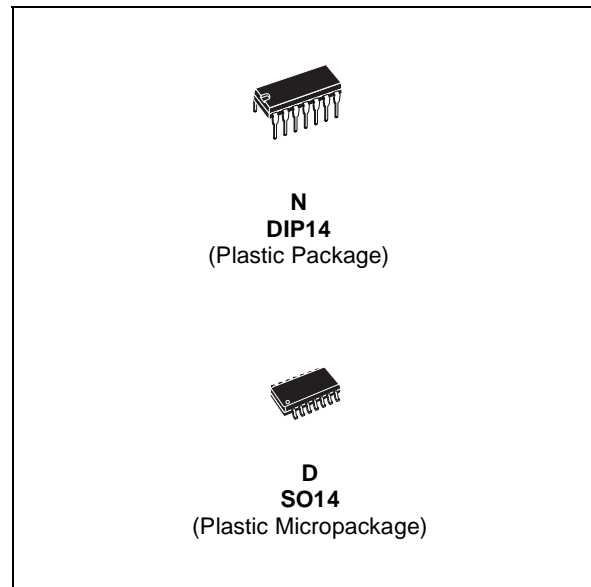
The patented input stage circuit allows small input signal swings below the negative supply voltage and prevents phase inversion when the inputs are over drivers.

### ORDER CODE

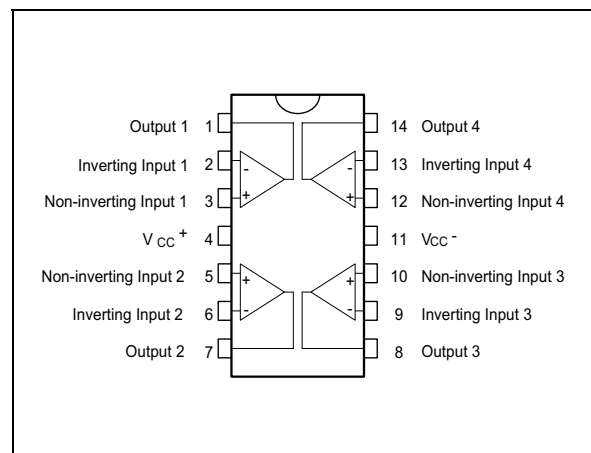
Part Number	Temperature Range	Package	
		N	D
LS404C	0°C, +70°C	•	•
LS404I	-40°C, +105°C	•	•
LS404M	-55°C, +125°C	•	•

**Example :** LS204CN

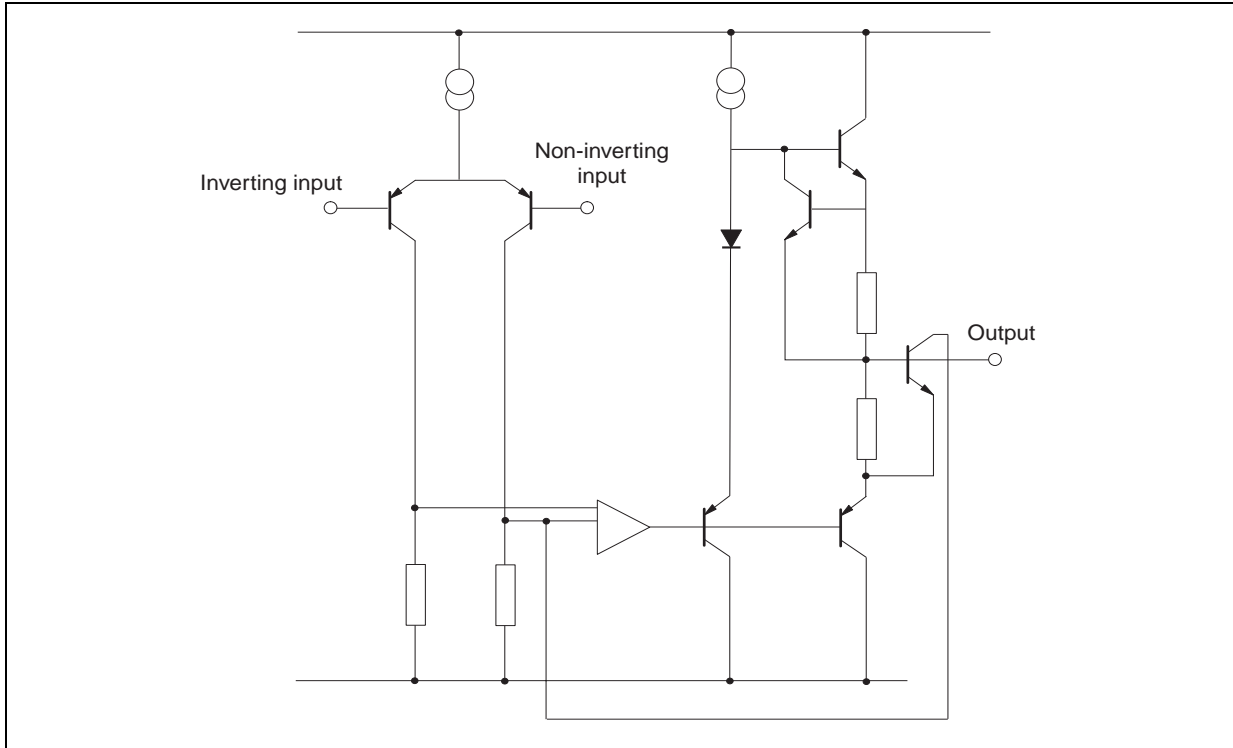
N = Dual in Line Package (DIP)  
D = Small Outline Package (SO) - also available in Tape & Reel (DT)



### PIN CONNECTIONS (top view)



**SCHEMATIC DIAGRAM (1/4 LS404)**



**ABSOLUTE MAXIMUM RATINGS**

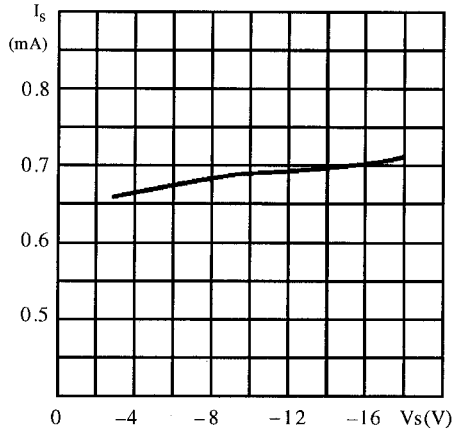
Symbol	Parameter		Value	Unit
$V_{CC}$	Supply voltage		$\pm 18$	V
$V_i$	Input Voltage	Positive Negative	$+V_{CC}$ $-V_{CC} - 0.5$	V
$V_{id}$	Differential Input Voltage		$\pm(V_{CC} - 1)$	V
$T_{oper}$	Operating Temperature Range	LS204C LS204I LS204I	0 to +70 -40 to +105 -55 to +125	$^{\circ}\text{C}$
$P_{tot}$	Power Dissipation at $T_{amb} = 70^{\circ}\text{C}$		400	mW
$T_{stg}$	Storage Temperature Range		-65 to +150	$^{\circ}\text{C}$

## ELECTRICAL CHARACTERISTICS

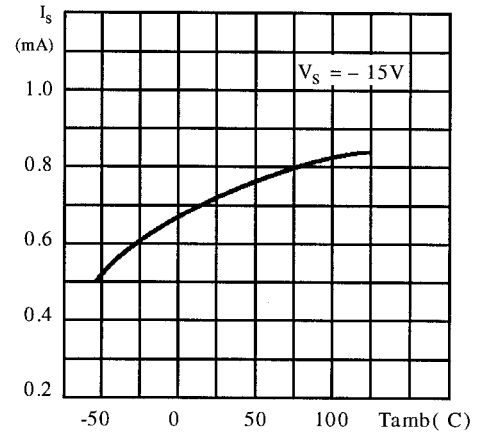
 $V_{CC} = \pm 15V$ ,  $T_{amb} = 25^{\circ}C$  (unless otherwise specified)

Symbol	Parameter	LS4041 - LS404M			LS404C			Unit
		Min.	Typ.	Max.	Min.	Typ.	Max.	
$I_{CC}$	Supply Current		1.3	2		1.5	3	mA
$I_{ib}$	Input Bias Current		50	200		100	300	nA
$R_i$	Input Resistance ( $f = 1kHz$ )		1			1		M $\Omega$
$V_{io}$	Input Offset Voltage ( $R_s \leq 10k\Omega$ )		0.7	2.5		0.5	5	mV
$DV_{io}$	Input Offset Voltage Drift ( $R_s \leq 10k\Omega$ ) $T_{min} < T_{op} < T_{max}$		5			5		$\mu V/^{\circ}C$
$I_{io}$	Input Offset Current		10	40		20	80	nA
$DI_{io}$	Input Offset Current Drift $T_{min} < T_{op} < T_{max}$		0.08			0.1		nA/ $^{\circ}C$
$I_{os}$	Output Short-circuit Current		23			23		mA
$A_{vd}$	Large Signal Voltage Gain $R_L = 2k\Omega$ , $V_{CC} = \pm 15V$ $V_{CC} = \pm 4V$	90	100 95		86	100 95		dB
GBP	Gain Bandwidth Product $f = 100kHz$ , $R_L = 2k$ , $C_L = 100pF$	1.8	3		1.5	2.5		MHz
$e_n$	Equivalent Input Noise Voltage $f = 1kHz$ , $R_s = 50\Omega$ $R_s = 1k\Omega$ $R_s = 10k\Omega$		8 10 18	15		10 12 20		$\frac{nV}{\sqrt{Hz}}$
THD	Total Harmonic Distortion Unity Gain $R_L = 2k\Omega$ , $V_o = 2V_{pp}$ $f = 1kHz$ $f = 20kHz$		0.01 0.03	0.4		0.01 0.03		%
$\pm V_{opp}$	Output Voltage Swing $R_L = 2k\Omega$ , $V_{CC} = \pm 15V$ $V_{CC} = \pm 4V$	$\pm 13$	$\pm 3$		$\pm 13$	$\pm 3$		V
$V_{opp}$	Large Signal Voltage Swing $f = 10kHz$ , $R_L = 10k\Omega$ $R_L = 1k\Omega$		22 20			22 20		V <sub>pp</sub>
SR	Slew Rate ( $R_L = 2k\Omega$ , unity gain)	0.8	1.5			1		V/ $\mu s$
SVR	Supply Voltage Rejection Ratio $V_{ic} = 1V$ , $f = 100Hz$	90	94		86	90		dB
CMR	Common Mode Rejection Ratio $V_{ic} = 10V$	90	94		86	90		dB
$V_{o1}/V_{o2}$	Channel Separation ( $f = 1kHz$ )	100	120			120		dB

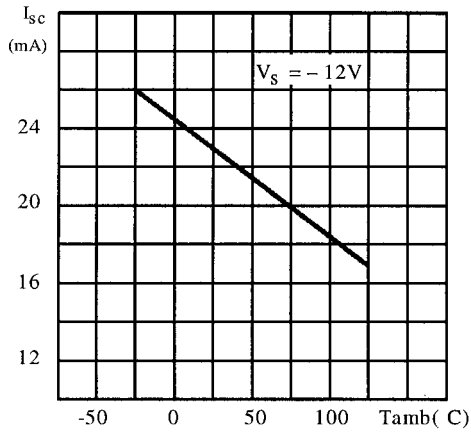
**Figure 1 :** Supply Current versus Supply Voltage



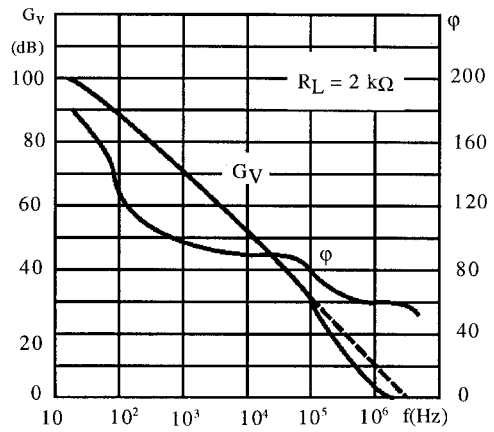
**Figure 2 :** Supply Current versus Ambient Temperature



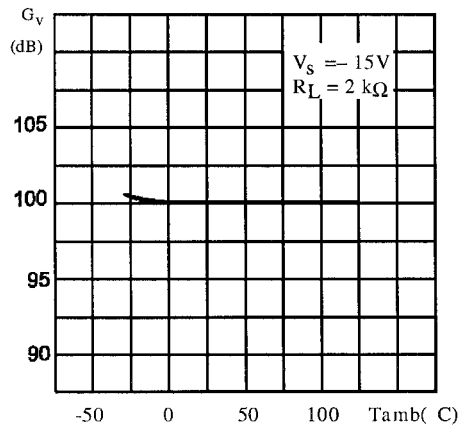
**Figure 3 :** Output Short Circuit Current versus Ambient Temperature



**Figure 4 :** Open Loop Frequency and Phase Response



**Figure 5 :** Output Loop Gain versus Ambient Temperature



**Figure 6 :** Supply Voltage Rejection versus Frequency

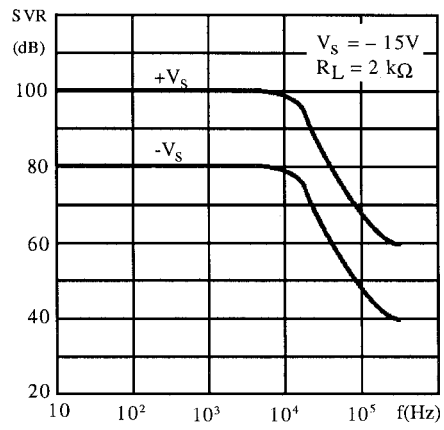


Figure 7 : Large Signal Frequency Response

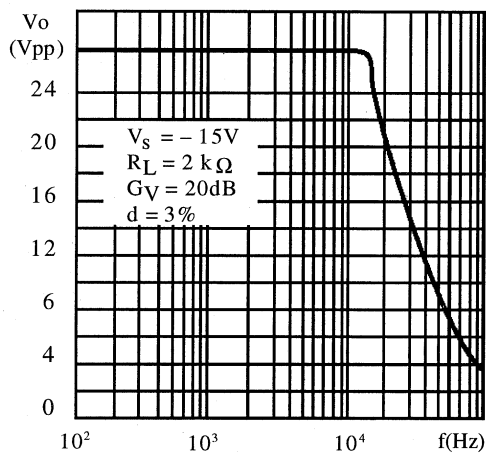


Figure 8 : Output Voltage Swing versus Load Resistance

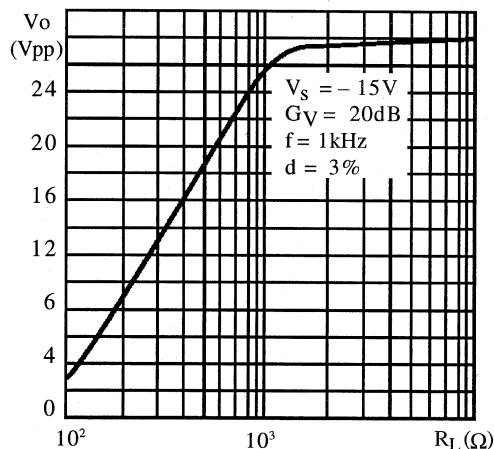


Figure 9 : Total Input Noise versus Frequency

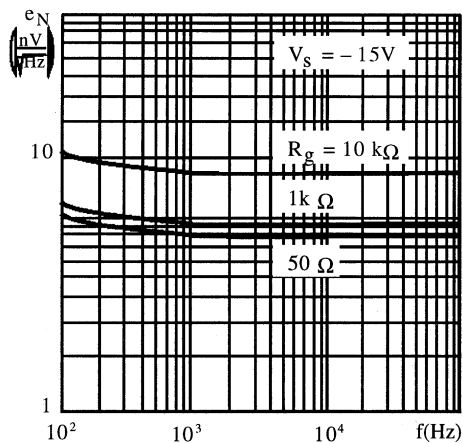


Figure 10 : Amplitude Response

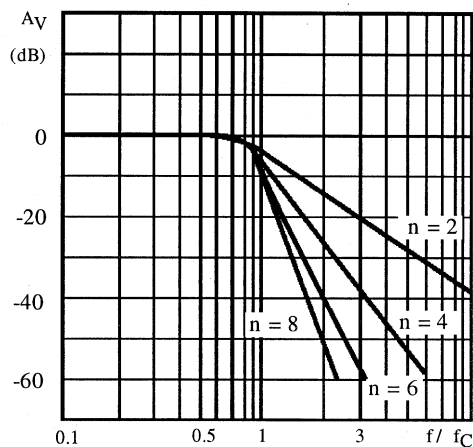


Figure 11 : Amplitude Response

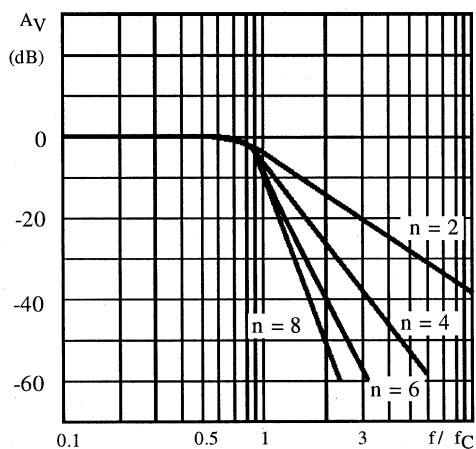
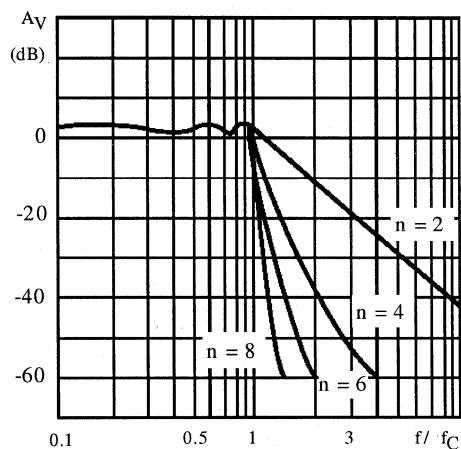


Figure 12 : Amplitude Response ( $\pm 1\text{dB}$  ripple)



**APPLICATION INFORMATION: Active low-pass filter**

**BUTTERWORTH**

The Butterworth is a "maximally flat" amplitude response filter (figure 10) Butterworth filters are used for filtering signals in data acquisition systems to prevent aliasing errors in samples-data applications and for general purpose low-pass filtering.

The cut-off frequency  $F_c$ , is the frequency at which the amplitude response is down 3dB. The attenuation rate beyond the cutoff frequency is  $n6$  dB per octave of frequency where  $n$  is the order (number of poles) of the filter.

Other characteristics :

- Flattest possible amplitude response
- Excellent gain accuracy at low frequency end of passband

**BESSEL**

The Bessel is a type of "linear phase" filter. Because of their linear phase characteristics, these filters approximate a constant time delay over a limited frequency range. Bessel filters pass transient waveforms with a minimum of distortion. They are also used to provide time delays for low pass filtering of modulated waveforms and as a "running average" type filter.

The maximum phase shift is  $\frac{-n\pi}{2}$  radians where

$n$  is the order (number of poles) of the filter. The cut-off frequency  $f_c$ , is defined as the frequency at which the phase shift is one half of this value.

The table below shows the typical overshoot and settling time response of the low pass filters to a step input.

	Number of Poles	Peak Overshoot	Settling Time (% of final value)		
		% Overshoot	±1%	±0.1%	±0.01%
Butterworth	2	4	1.1 $F_c$ sec.	1.7 $F_c$ sec.	1.9 $F_c$ sec.
	4	11	1.7/ $f_c$	2.8/ $f_c$	3.8/ $f_c$
	6	14	2.4/ $f_c$	3.9S/ $f_c$	5.0S/ $f_c$
	8	14	3.1/ $f_c$	5.1/ $f_c$	7.1/ $f_c$
Bessel	2	0.4	0.8/ $f_c$	1.4/ $f_c$	1.7/ $f_c$
	4	0.8	1.0/ $f_c$	1.8/ $f_c$	2.4/ $f_c$
	6	0.6	1.3/ $f_c$	2.1/ $f_c$	2.7/ $f_c$
	8	0.1	1.6/ $f_c$	2.3/ $f_c$	3.2/ $f_c$
Chebyshev (ripple ±0.25dB)	2	11	1.1/ $f_c$	1.6/ $f_c$	-
	4	18	3.0/ $f_c$	5.4/ $f_c$	-
	6	21	5.9/ $f_c$	10.4/ $f_c$	-
	8	23	8.4/ $f_c$	16.4/ $f_c$	-
Chebyshev (ripple ±1dB)	2	21	1.6/ $f_c$	2.7/ $f_c$	-
	4	28	4.8/ $f_c$	8.4/ $f_c$	-
	6	32	8.2/ $f_c$	16.3/ $f_c$	-
	8	34	11.6/ $f_c$	24.8/ $f_c$	-

Design of 2nd order active low pass filter (Sallen and Key configuration unity gain op-amp)

For accurate delay, the cut-off frequency should be twice the maximum signal frequency.

The following table can be used to obtain the -3dB frequency of the filter.

	2 Pole	4 Pole	6 Pole	8 Pole
-3dB Frequency	0.77 $f_c$	0.67 $f_c$	0.57 $f_c$	0.50 $f_c$

Other characteristics :

- Selectivity not as great as Chebyshev or Butterworth
- Very little overshoot response to step inputs
- Fast rise time

**CHEBYSCHEV**

Chebyshev filters have greater selectivity than either Bessel or Butterworth at the expense of ripple in the passband (figure 11).

Chebyshev filters are normally designed with peak-to-peak ripple values from 0.2dB to 2dB.

Increased ripple in the passband allows increased attenuation above the cut-off frequency.

The cut-off frequency is defined as the frequency at which the amplitude response passes through the specified maximum ripple band and enters the stop band.

Other characteristics :

- Greater selectivity
- Very non-linear phase response
- High overshoot response to step inputs

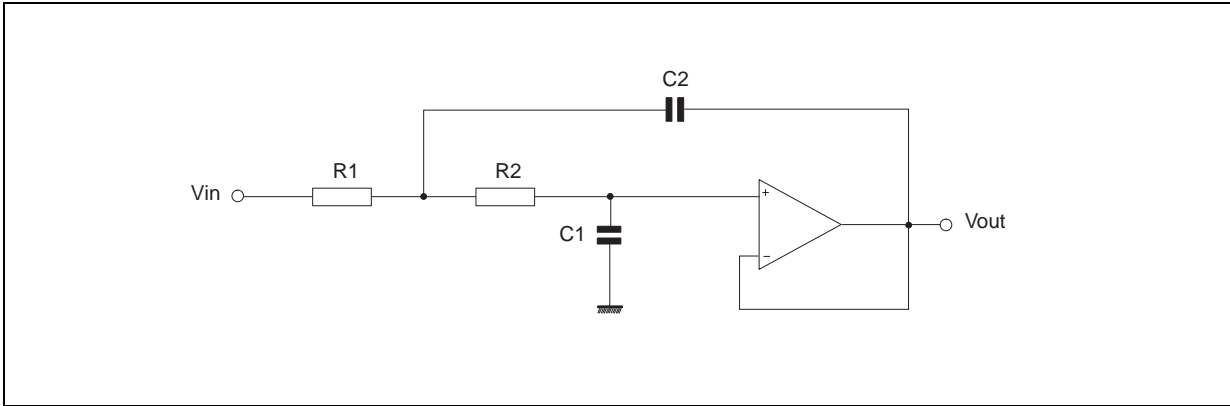


Fixed  $R = R1 = R2$ , we have (see figure 13)

$$C1 = \frac{1}{R} \frac{\zeta}{\omega_c}$$

$$C2 = \frac{1}{R} \frac{1}{\xi \omega_c}$$

**Figure 13 :** Filter Configuration



Three parameters are needed to characterize the frequency and phase response of a 2nd order active filter: the gain ( $G_v$ ), the damping factor ( $\xi$ ) or the Q factor ( $Q = 2 \xi^{-1}$ ), and the cutoff frequency ( $f_c$ ).

The higher order response are obtained with a series of 2nd order sections. A simple RC section is introduced when an odd filter is required.

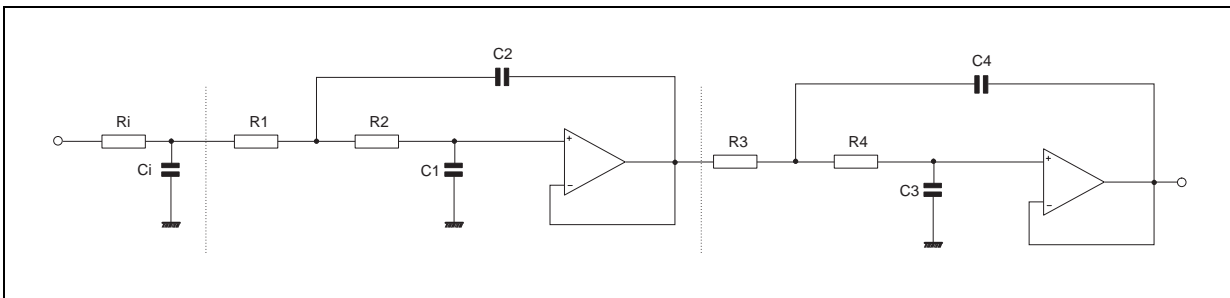
The choice of ' $\xi$ ' (or Q factor) determines the filter response (see table 1).

**Table 1**

Filter Response	$\xi$	Q	Cutoff Frequency $f_c$
Bessel	$\frac{\sqrt{3}}{2}$	$\frac{\sqrt{1}}{3}$	Frequency at which Phase Shift is $-90^\circ$
Butterworth	$\frac{\sqrt{2}}{2}$	$\frac{\sqrt{1}}{2}$	Frequency at which $G_v = -3\text{dB}$
Chebyshev	$\frac{\sqrt{2}}{2}$	$\frac{\sqrt{1}}{2}$	Frequency at which the amplitude response passes through specified max. ripple band and enters the stop bank.

**EXAMPLE**

**Figure 14 :** 5th Order Low-pass Filter (Butterworth) with Unity Gain configuration



In the circuit of figure 14, for  $f_c = 3.4\text{kHz}$  and  $R_i = R_1 = R_2 = R_3 = 10\text{k}\Omega$ , we obtain:

$$C_i = 1.354 \frac{1}{R} \frac{1}{2\pi f_c} = 6.33\text{nF}$$

$$C_1 = 0.421 \frac{1}{R} \frac{1}{2\pi f_c} = 1.97\text{nF}$$

$$C_2 = 1.753 \frac{1}{R} \frac{1}{2\pi f_c} = 8.20\text{nF}$$

$$C_3 = 0.309 \frac{1}{R} \frac{1}{2\pi f_c} = 1.45\text{nF}$$

$$C_4 = 3.325 \frac{1}{R} \frac{1}{2\pi f_c} = 15.14\text{nF}$$

The attenuation of the filter is 30dB at 6.8kHz and better than 60dB at 15kHz.

The same method, referring to table 2 and figure 15 is used to design high-pass filter. In this case the damping factor is found by taking the reciprocal of the numbers in table 2. For  $f_c = 5\text{kHz}$  and  $C_i = C_1 = C_2 = C_3 = 1\text{nF}$  we obtain:

$$R_i = \frac{1}{0.354} \frac{1}{C} \frac{1}{2\pi f_c} = 25.5\text{k}\Omega$$

$$R_1 = \frac{1}{0.421} \frac{1}{C} \frac{1}{2\pi f_c} = 75.6\text{k}\Omega$$

$$R_2 = \frac{1}{1.753} \frac{1}{C} \frac{1}{2\pi f_c} = 18.2\text{k}\Omega$$

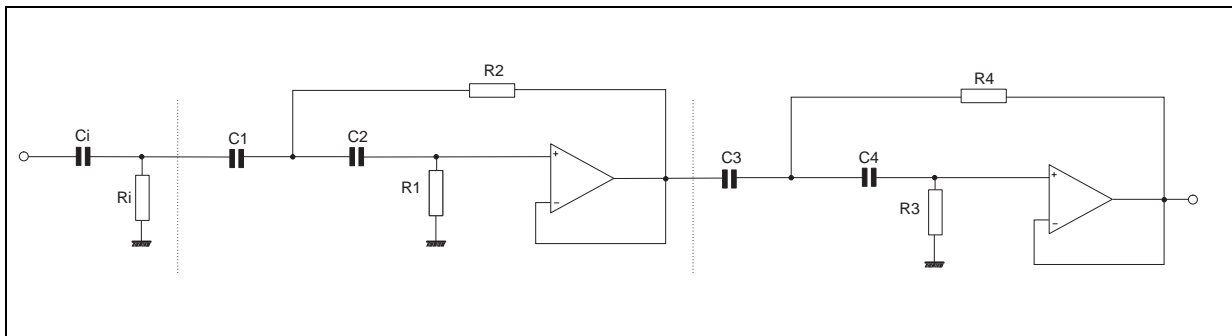
$$R_3 = \frac{1}{0.309} \frac{1}{C} \frac{1}{2\pi f_c} = 103\text{k}\Omega$$

$$R_4 = \frac{1}{3.325} \frac{1}{C} \frac{1}{2\pi f_c} = 9.6\text{k}\Omega$$

**Table 2 :** Damping Factor for Low-pass Butterworth Filters

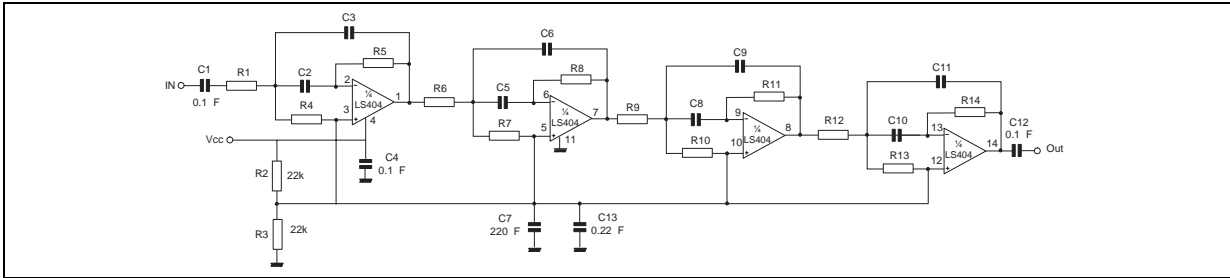
Order	$C_i$	$C_1$	$C_2$	$C_3$	$C_4$	$C_5$	$C_6$	$C_7$	$C_8$
2		0.707	1.41						
3	1.392	0.202	3.54						
4		0.92	1.08	0.38	2.61				
5	1.354	0.421	1.75	0.309	3.235				
6		0.966	1.035	0.707	1.414	0.259	3.86		
7	1.336	0.488	1.53	0.623	1.604	0.222	4.49		
8		0.98	1.02	0.83	1.20	0.556	1.80	0.195	5.125

**Figure 15 :** 5th Order High-pass Filter (Butterworth) with Unity Gain configuration

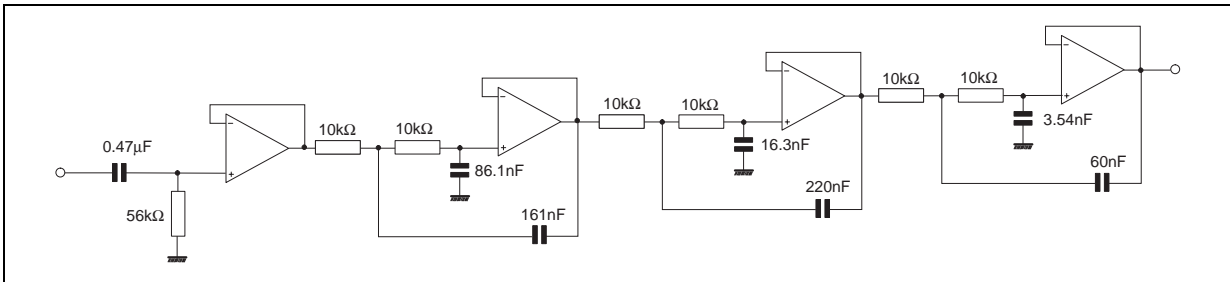




**Figure 16 : Multiple Feedback 8-pole Bandpass Filter**

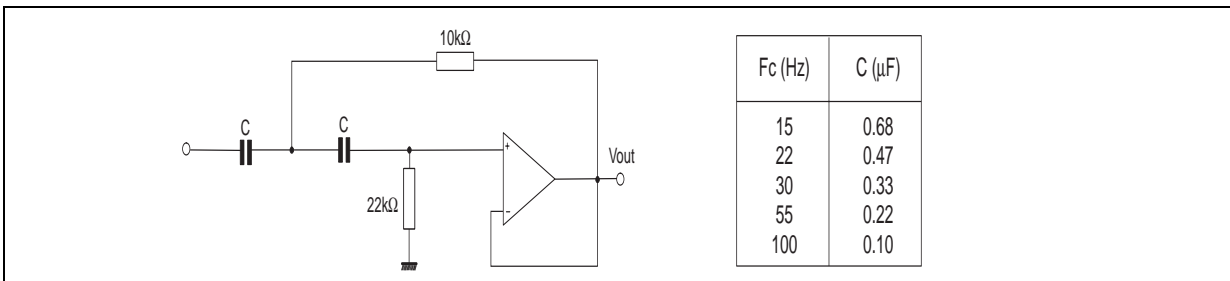


**Figure 17 : Six pole 355Hz Low-pass Filter (chebychev type)**

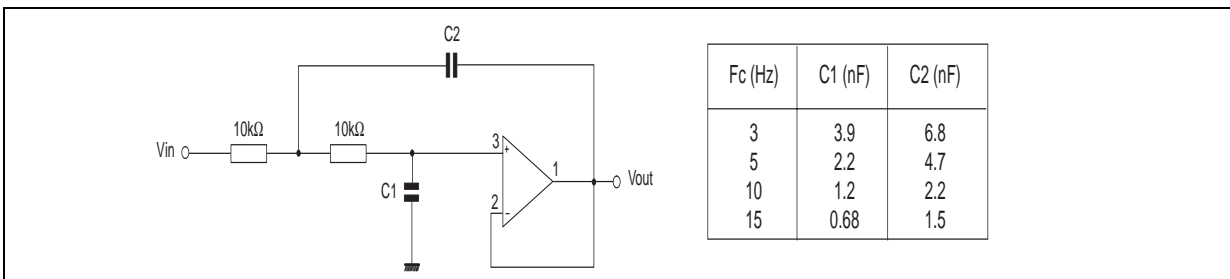


This is a - pole Chebyshev type with  $\pm 0.25\text{dB}$  ripple in the passband. A decoupling stage is used to avoid the influence of the input impedance on the filter's characteristics. The attenuation is about 55dB at 710Hz and reaches 80dB at 1065Hz. the in band attenuation is limited in practise to the  $\pm 0.25\text{dB}$  ripple and does not exceed 0.5dB at  $0.9f_c$ .

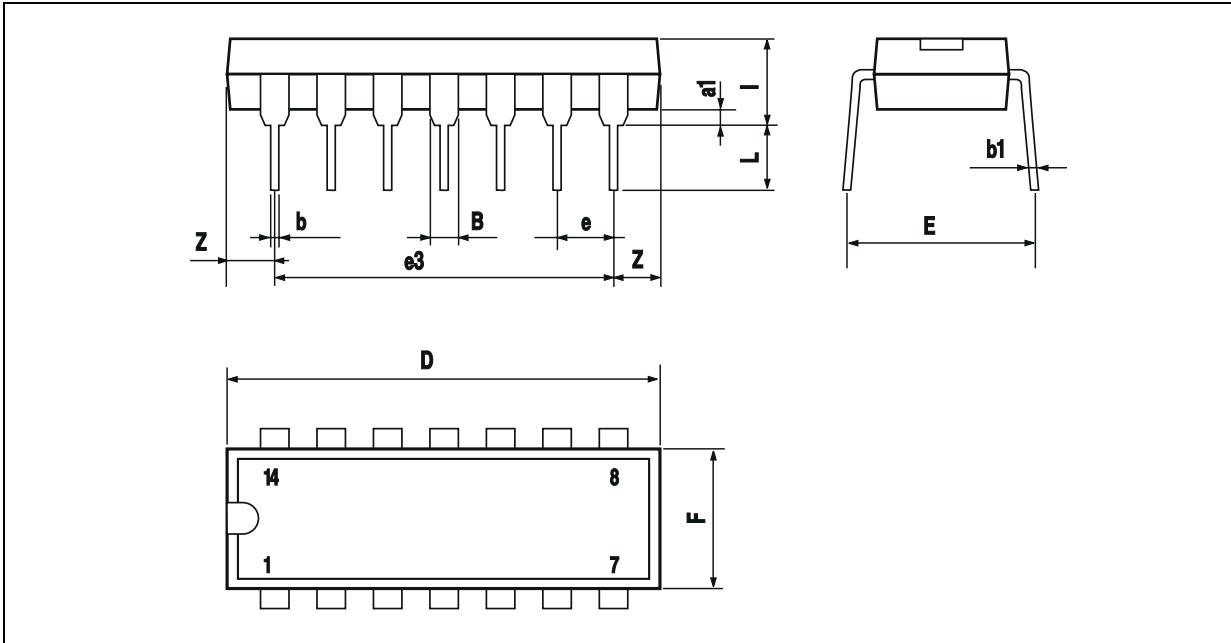
**Figure 18 : Subsonic Filter ( $G_v = 0\text{dB}$ )**



**Figure 19 : High Cut filter ( $G_v = 0\text{dB}$ )**

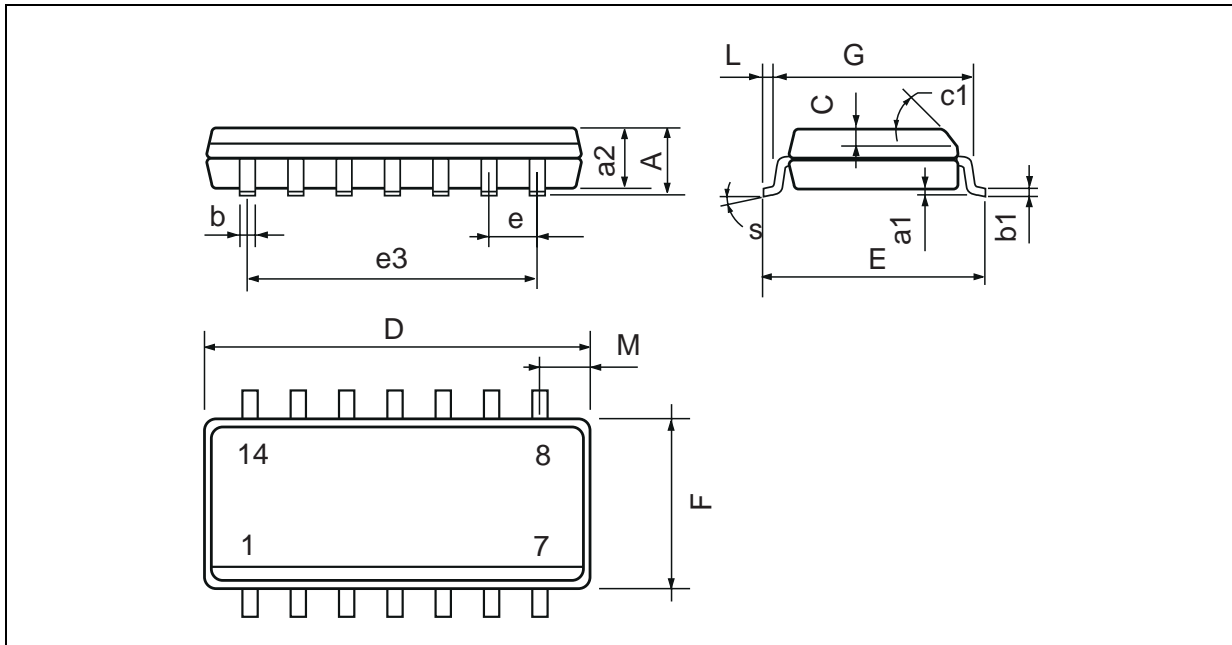


**PACKAGE MECHANICAL DATA**  
14 PINS - PLASTIC PACKAGE



Dimensions	Millimeters			Inches		
	Min.	Typ.	Max.	Min.	Typ.	Max.
a1	0.51			0.020		
B	1.39		1.65	0.055		0.065
b		0.5			0.020	
b1		0.25			0.010	
D			20			0.787
E		8.5			0.335	
e		2.54			0.100	
e3		15.24			0.600	
F			7.1			0.280
i			5.1			0.201
L		3.3			0.130	
Z	1.27		2.54	0.050		0.100

**PACKAGE MECHANICAL DATA**  
14 PINS - PLASTIC MICROPACKAGE (SO)



Dimensions	Millimeters			Inches		
	Min.	Typ.	Max.	Min.	Typ.	Max.
A			1.75			0.069
a1	0.1		0.2	0.004		0.008
a2			1.6			0.063
b	0.35		0.46	0.014		0.018
b1	0.19		0.25	0.007		0.010
C		0.5			0.020	
c1	45° (typ.)					
D (1)	8.55		8.75	0.336		0.344
E	5.8		6.2	0.228		0.244
e		1.27			0.050	
e3		7.62			0.300	
F (1)	3.8		4.0	0.150		0.157
G	4.6		5.3	0.181		0.208
L	0.5		1.27	0.020		0.050
M			0.68			0.027
S	8° (max.)					

Note : (1) D and F do not include mold flash or protrusions - Mold flash or protrusions shall not exceed 0.15mm (.066 inc) ONLY FOR DATA BOOK.

Information furnished is believed to be accurate and reliable. However, STMicroelectronics assumes no responsibility for the consequences of use of such information nor for any infringement of patents or other rights of third parties which may result from its use. No license is granted by implication or otherwise under any patent or patent rights of STMicroelectronics. Specifications mentioned in this publication are subject to change without notice. This publication supersedes and replaces all information previously supplied. STMicroelectronics products are not authorized for use as critical components in life support devices or systems without express written approval of STMicroelectronics.

© The ST logo is a registered trademark of STMicroelectronics

© 2001 STMicroelectronics - Printed in Italy - All Rights Reserved  
STMicroelectronics GROUP OF COMPANIES

Australia - Brazil - Canada - China - Finland - France - Germany - Hong Kong - India - Israel - Italy - Japan - Malaysia  
Malta - Morocco - Singapore - Spain - Sweden - Switzerland - United Kingdom - United States

© <http://www.st.com>

