

Wide bandwidth dual JFET operational amplifiers

Features

- Low power consumption
- Wide common-mode (up to V_{CC^+}) and differential voltage range
- Low input bias and offset current
- Output short-circuit protection
- High input impedance JFET input stage
- Internal frequency compensation
- Latch up free operation
- High slew rate 16 V/ μ s (typical)

Description

These circuits are high speed JFET input dual operational amplifiers incorporating well matched, high voltage JFET and bipolar transistors in a monolithic integrated circuit.

The devices feature high slew rates, low input bias and offset currents, and low offset voltage temperature coefficient.

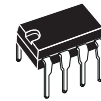

N
DIP8
(Plastic package)



D
SO-8
(Plastic micro package)

Pin connections
(top view)

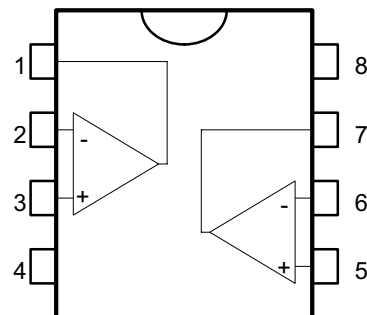

- 1 - Output1
- 2 - Inverting input 1
- 3 - Non-inverting input 1
- 4 - V_{CC^-}
- 5 - Non-inverting input 2
- 6 - Inverting input 2
- 7 - Output 2
- 8 - V_{CC^+}

1 Schematics

Figure 1. Schematic diagram (each amplifier)

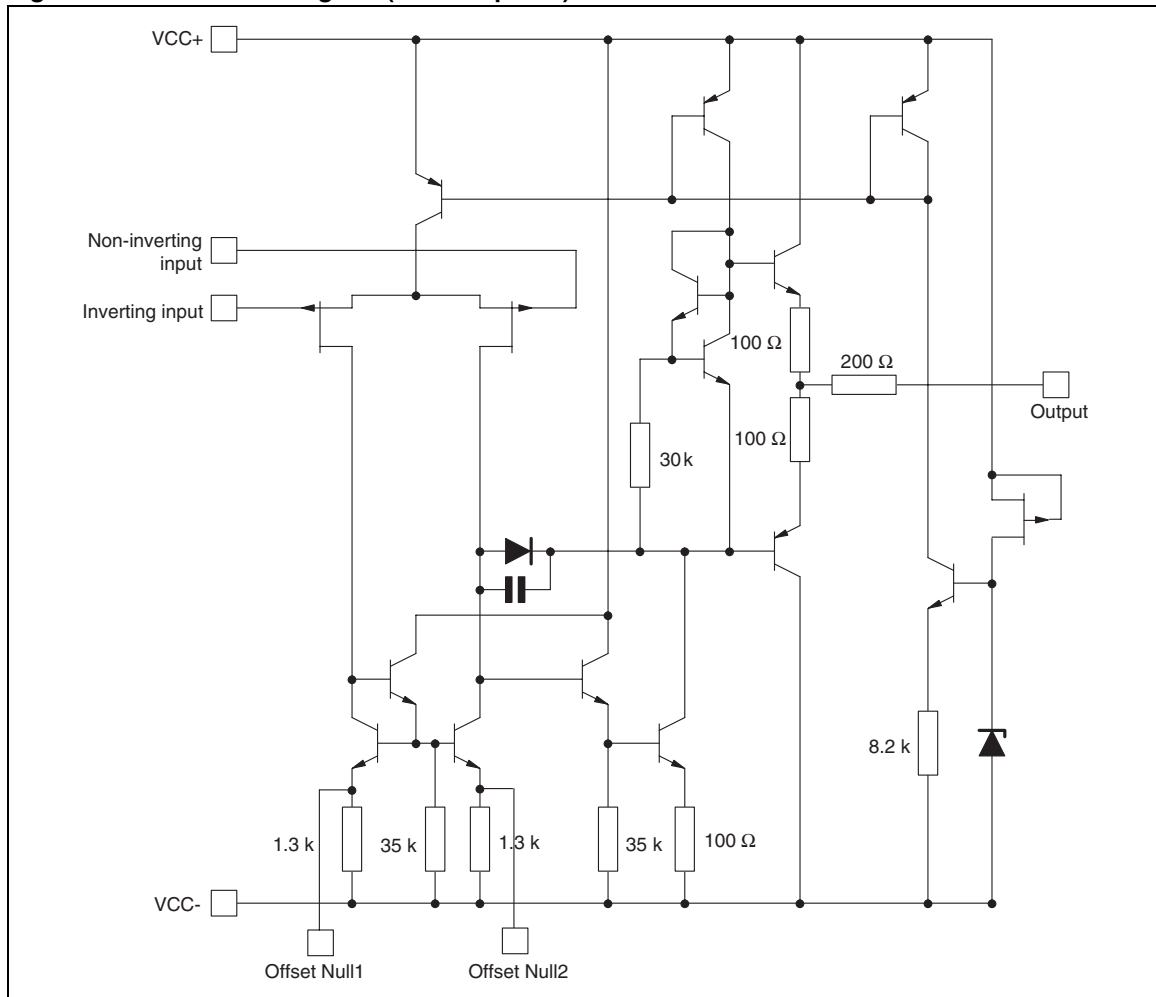

2 Absolute maximum ratings and operating conditions

Table 1. Absolute maximum ratings

| Symbol | Parameter | Value | Unit |
|------------|---|-------------|------|
| V_{CC} | Supply voltage ⁽¹⁾ | ±18 | V |
| V_i | Input voltage ⁽²⁾ | ±15 | V |
| V_{id} | Differential input voltage ⁽³⁾ | ±30 | V |
| R_{thja} | Thermal resistance junction to ambient ⁽⁴⁾ | | |
| | SO-8 DIP8 | 125 85 | °C/W |
| R_{thjc} | Thermal resistance junction to case ⁽⁴⁾ | | |
| | SO-8 DIP8 | 40 41 | °C/W |
| | Output short-circuit duration ⁽⁵⁾ | Infinite | |
| T_{stg} | Storage temperature range | -65 to +150 | °C |
| ESD | HBM: human body model ⁽⁶⁾ | 1 | kV |
| | MM: machine model ⁽⁷⁾ | 200 | V |
| | CDM: charged device model ⁽⁸⁾ | 1.5 | kV |

- All voltage values, except differential voltage, are with respect to the zero reference level (ground) of the supply voltages where the zero reference level is the midpoint between V_{CC}^+ and V_{CC}^- .
- The magnitude of the input voltage must never exceed the magnitude of the supply voltage or 15 volts, whichever is less.
- Differential voltages are the non-inverting input terminal with respect to the inverting input terminal.
- Short-circuits can cause excessive heating and destructive dissipation. Values are typical.
- The output may be shorted to ground or to either supply. Temperature and/or supply voltages must be limited to ensure that the dissipation rating is not exceeded.
- Human body model: a 100 pF capacitor is charged to the specified voltage, then discharged through a 1.5 kΩ resistor between two pins of the device. This is done for all couples of connected pin combinations while the other pins are floating.
- Machine model: a 200 pF capacitor is charged to the specified voltage, then discharged directly between two pins of the device with no external series resistor (internal resistor < 5 Ω). This is done for all couples of connected pin combinations while the other pins are floating.
- Charged device model: all pins and the package are charged together to the specified voltage and then discharged directly to the ground through only one pin. This is done for all pins.

Table 2. Operating conditions

| Symbol | Parameter | LF253 | LF353 | Unit |
|------------|--------------------------------------|-------------|----------|------|
| V_{CC} | Supply voltage | 6 to 36 | | V |
| T_{oper} | Operating free-air temperature range | -40 to +105 | 0 to +70 | °C |

3 Electrical characteristics

Table 3. Electrical characteristics at $V_{CC} = \pm 15\text{ V}$, $T_{amb} = +25^\circ\text{C}$ (unless otherwise specified)

| Symbol | Parameter | Min. | Typ. | Max. | Unit |
|-----------------|---|----------------------|------------|------------|--------------------------------------|
| V_{io} | Input offset voltage ($R_S = 10\text{k}\Omega$) $T_{min} \leq T_{amb} \leq T_{max}$ | | 3 | 10 13 | mV |
| DV_{io} | Input offset voltage drift | | 10 | | $\mu\text{V}/^\circ\text{C}$ |
| I_{io} | Input offset current ⁽¹⁾ $T_{min} \leq T_{amb} \leq T_{max}$ | | 5 | 100 4 | pA nA |
| I_{ib} | Input bias current ⁽¹⁾ $T_{min} \leq T_{amb} \leq T_{max}$ | | 20 | 200 20 | pA nA |
| A_{vd} | Large signal voltage gain ($R_L = 2\text{k}\Omega$, $V_o = \pm 10\text{V}$) $T_{min} \leq T_{amb} \leq T_{max}$ | 50 25 | 200 | | V/mV |
| SVR | Supply voltage rejection ratio ($R_S = 10\text{k}\Omega$) $T_{min} \leq T_{amb} \leq T_{max}$ | 80 80 | 86 | | dB |
| I_{CC} | Supply current, no load $T_{min} \leq T_{amb} \leq T_{max}$ | | 1.4 | 3.2 3.2 | mA |
| V_{icm} | Input common mode voltage range | ± 11 | +15 -12 | | V |
| CMR | Common mode rejection ratio ($R_S = 10\text{k}\Omega$) $T_{min} \leq T_{amb} \leq T_{max}$ | 70 70 | 86 | | dB |
| I_{OS} | Output short-circuit current $T_{min} \leq T_{amb} \leq T_{max}$ | 10 10 | 40 | 60 60 | mA |
| $\pm V_{opp}$ | Output voltage swing $R_L = 2\text{k}\Omega$ $R_L = 10\text{k}\Omega$ $T_{min} \leq T_{amb} \leq T_{max}$ $R_L = 2\text{k}\Omega$ $R_L = 10\text{k}\Omega$ | 10 12 10 12 | 12 13.5 | | V |
| SR | Slew rate, $V_i = 10\text{V}$, $R_L = 2\text{k}\Omega$, $C_L = 100\text{pF}$, unity gain | 12 | 16 | | V/ μs |
| t_r | Rise time, $V_i = 20\text{mV}$, $R_L = 2\text{k}\Omega$, $C_L = 100\text{pF}$, unity gain | | 0.1 | | μs |
| K_{ov} | Overshoot, $V_i = 20\text{mV}$, $R_L = 2\text{k}\Omega$, $C_L = 100\text{pF}$, unity gain | | 10 | | % |
| GBP | Gain bandwidth product, $f = 100\text{kHz}$, $V_{in} = 10\text{mV}$, $R_L = 2\text{k}\Omega$, $C_L = 100\text{pF}$ | 2.5 | 4 | | MHz |
| R_i | Input resistance | | 10^{12} | | Ω |
| THD | Total harmonic distortion, $f = 1\text{kHz}$, $A_v = 20\text{dB}$, $R_L = 2\text{k}\Omega$, $C_L = 100\text{pF}$, $V_o = 2V_{pp}$ | | 0.01 | | % |
| e_n | Equivalent input noise voltage $R_S = 100\Omega$, $f = 1\text{KHz}$ | | 15 | | $\frac{\text{nV}}{\sqrt{\text{Hz}}}$ |
| ϕ_m | Phase margin | | 45 | | Degrees |
| V_{o1}/V_{o2} | Channel separation ($A_v = 100$) | | 120 | | dB |

1. The input bias currents are junction leakage currents which approximately double for every 10°C increase in the junction temperature.

Figure 2. Maximum peak-to-peak output voltage vs. frequency, $R_L = 2\text{ k}\Omega$

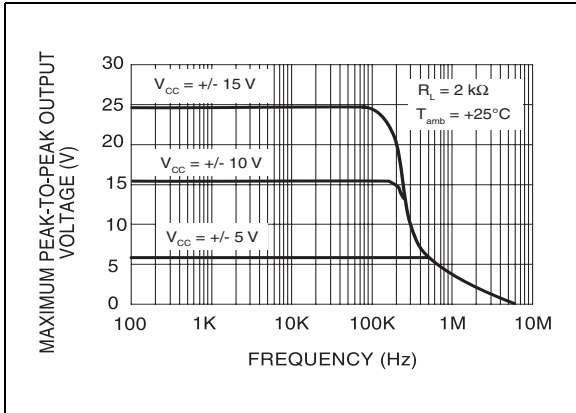

Figure 3. Maximum peak-to-peak output voltage vs. frequency, $R_L = 10\text{ k}\Omega$

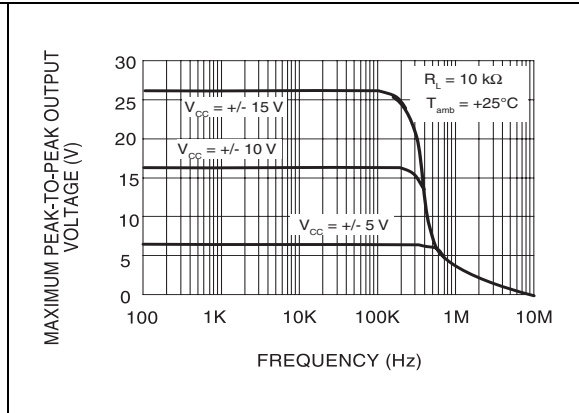

Figure 4. Maximum peak-to-peak output voltage versus frequency

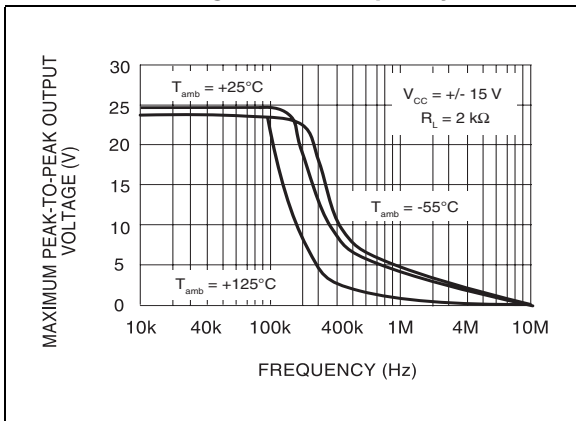

Figure 5. Maximum peak-to-peak output voltage versus free air temperature

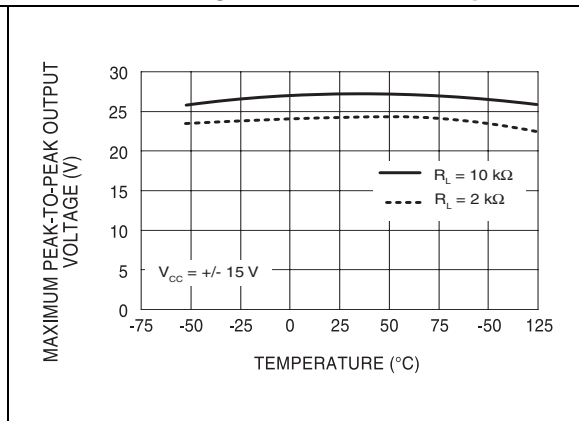

Figure 6. Maximum peak-to-peak output voltage versus load resistance

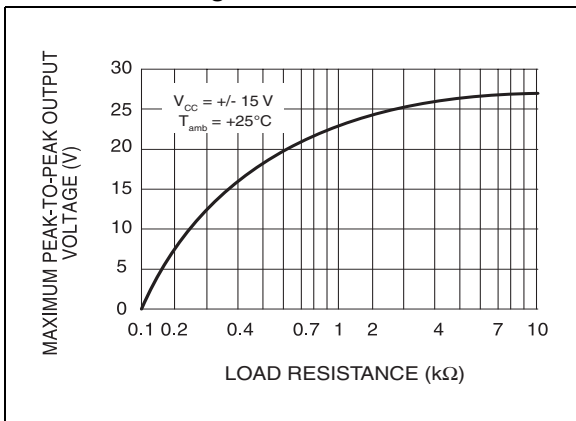

Figure 7. Maximum peak-to-peak output voltage versus supply voltage

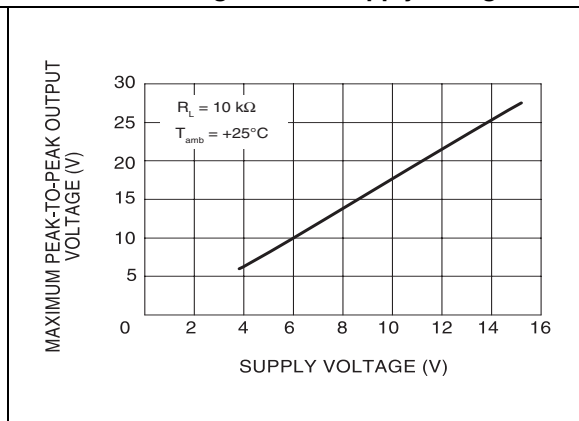

Figure 8. Input bias current versus free air temperature

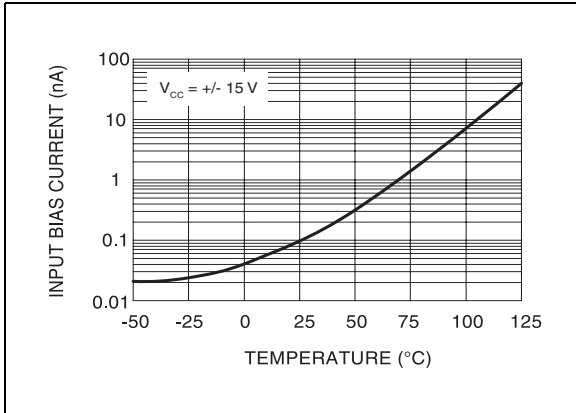

Figure 9. Large signal differential voltage amplification versus free air temp.

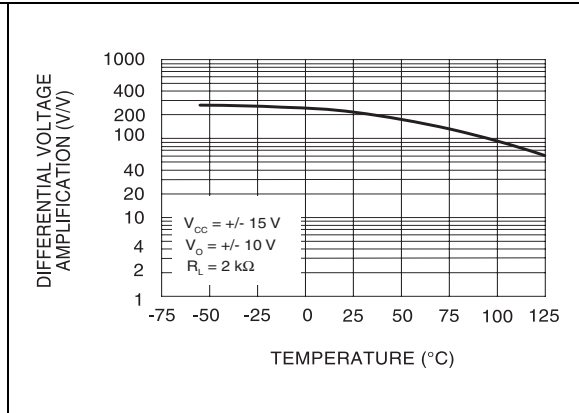

Figure 10. Large signal differential voltage amplification and phase shift versus frequency

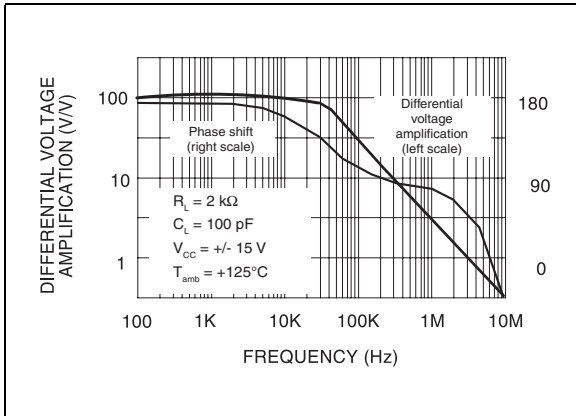

Figure 11. Total power dissipation versus free air temperature

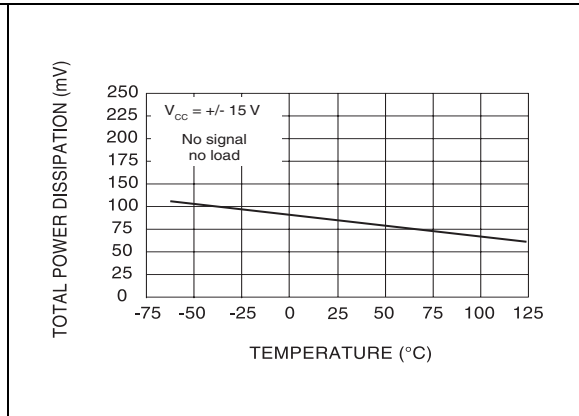

Figure 12. Supply current per amplifier versus free air temperature

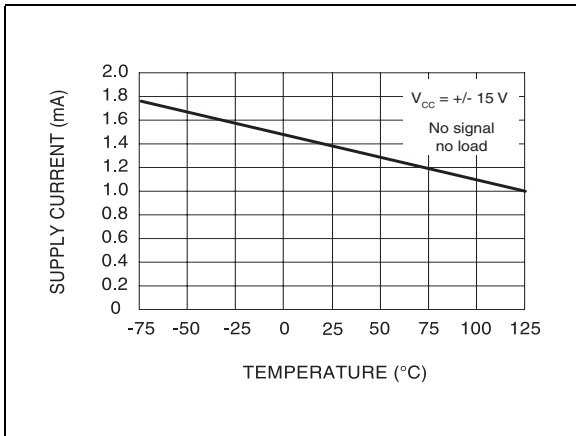

Figure 13. Supply current per amplifier versus supply voltage

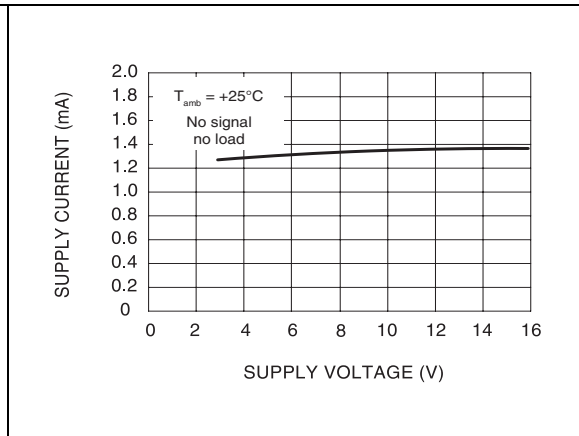

Figure 14. Common mode rejection ratio versus free air temperature

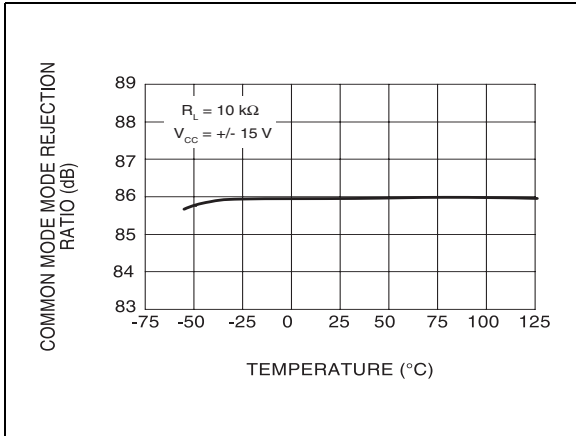

Figure 15. Voltage follower large signal pulse response

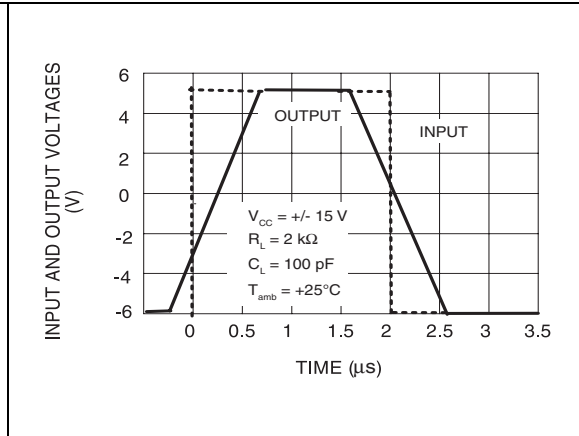

Figure 16. Output voltage versus elapsed time Figure 17. Equivalent input noise voltage versus frequency

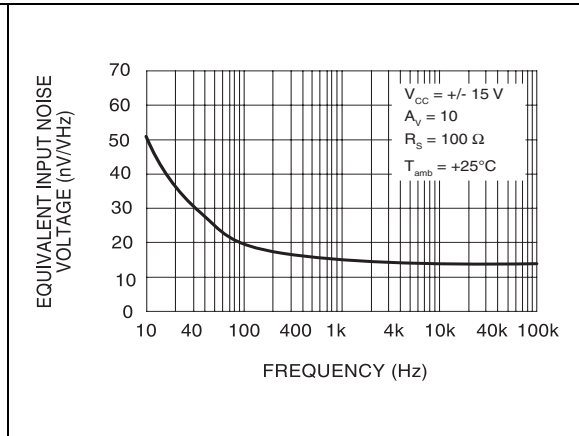
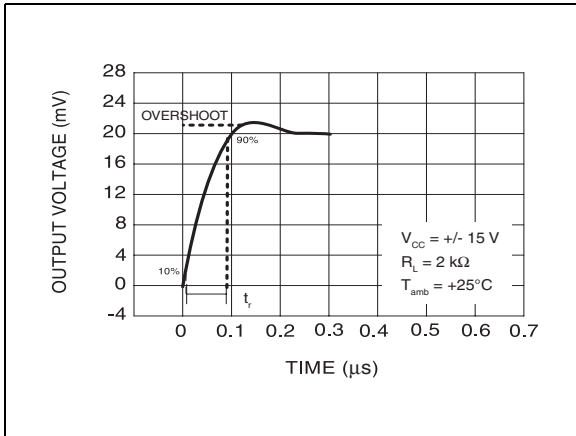
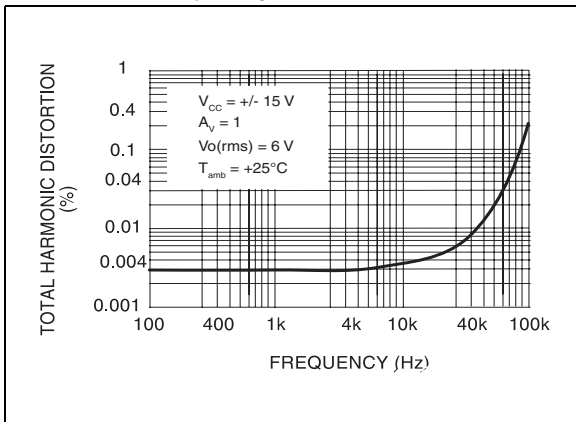

Figure 18. Total harmonic distortion versus frequency



4 Parameter measurement information

Figure 19. Voltage follower

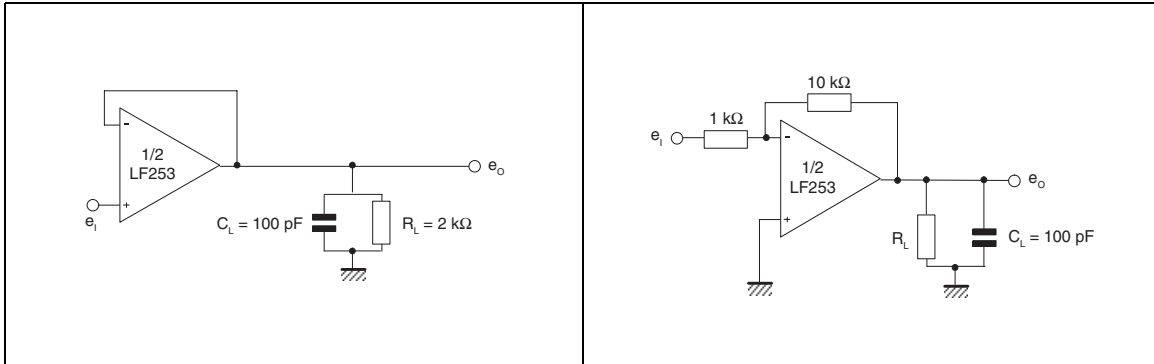
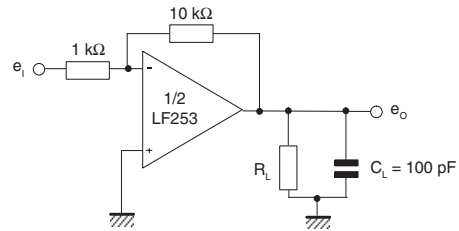
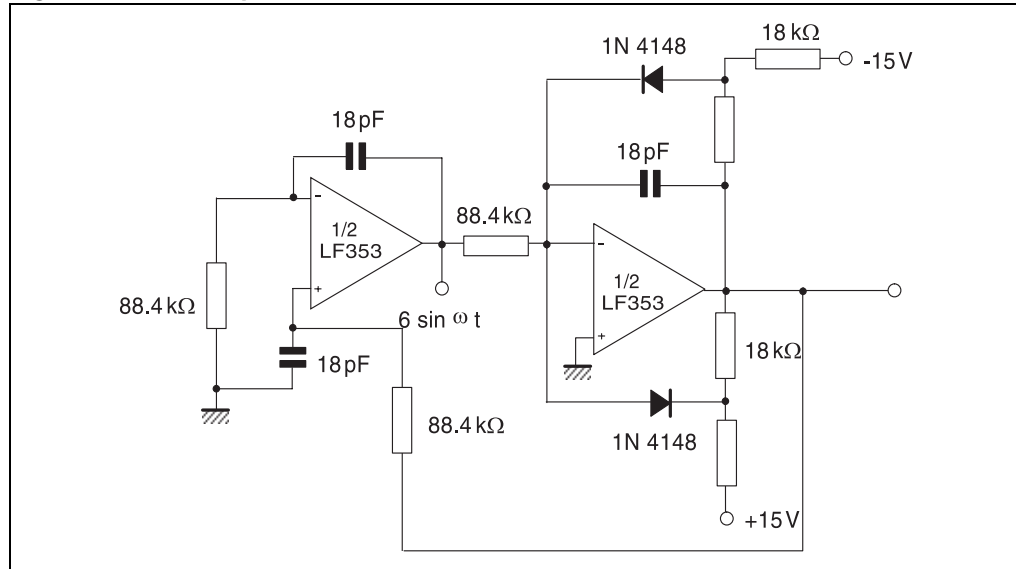

Figure 20. Gain of 10 inverting amplifier



5 Typical application

Figure 21. Quadruple oscillator



6 Package information

In order to meet environmental requirements, ST offers these devices in different grades of ECOPACK[®] packages, depending on their level of environmental compliance. ECOPACK[®] specifications, grade definitions and product status are available at: www.st.com. ECOPACK[®] is an ST trademark.

6.1 DIP8 package information

Figure 22. DIP8 package mechanical drawing

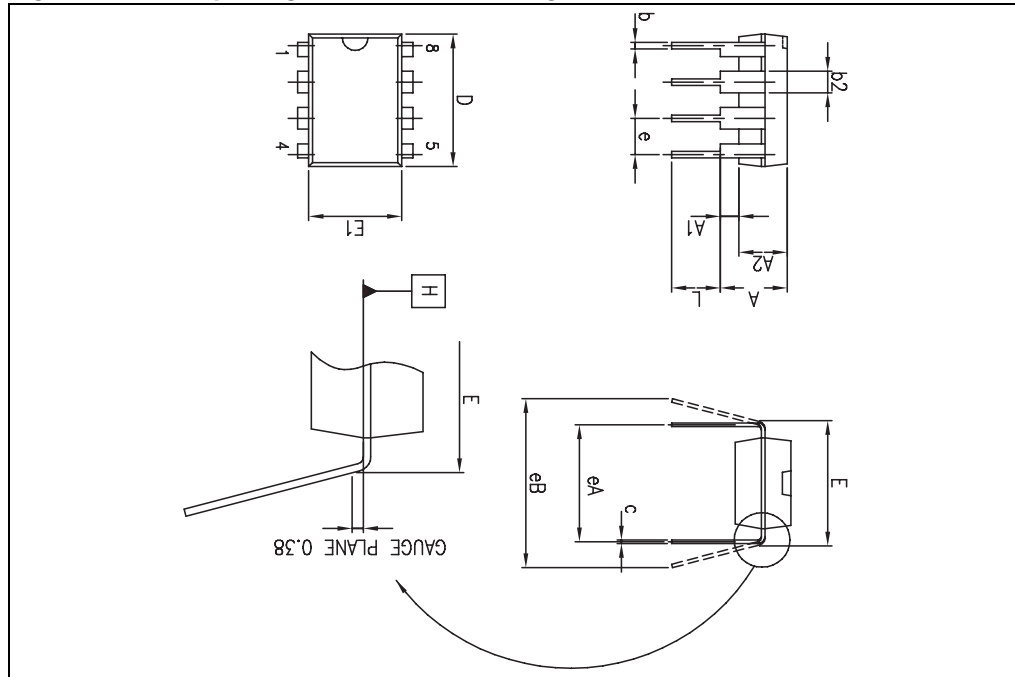

Table 4. DIP8 package mechanical data

| Ref. | Dimensions | | | | | |
|------|-------------|------|-------|--------|-------|-------|
| | Millimeters | | | Inches | | |
| | Min. | Typ. | Max. | Min. | Typ. | Max. |
| A | | | 5.33 | | | 0.210 |
| A1 | 0.38 | | | 0.015 | | |
| A2 | 2.92 | 3.30 | 4.95 | 0.115 | 0.130 | 0.195 |
| b | 0.36 | 0.46 | 0.56 | 0.014 | 0.018 | 0.022 |
| b2 | 1.14 | 1.52 | 1.78 | 0.045 | 0.060 | 0.070 |
| c | 0.20 | 0.25 | 0.36 | 0.008 | 0.010 | 0.014 |
| D | 9.02 | 9.27 | 10.16 | 0.355 | 0.365 | 0.400 |
| E | 7.62 | 7.87 | 8.26 | 0.300 | 0.310 | 0.325 |
| E1 | 6.10 | 6.35 | 7.11 | 0.240 | 0.250 | 0.280 |
| e | | 2.54 | | | 0.100 | |
| eA | | 7.62 | | | 0.300 | |
| eB | | | 10.92 | | | 0.430 |
| L | 2.92 | 3.30 | 3.81 | 0.115 | 0.130 | 0.150 |

6.2 SO-8 package information

Figure 23. SO-8 package mechanical drawing

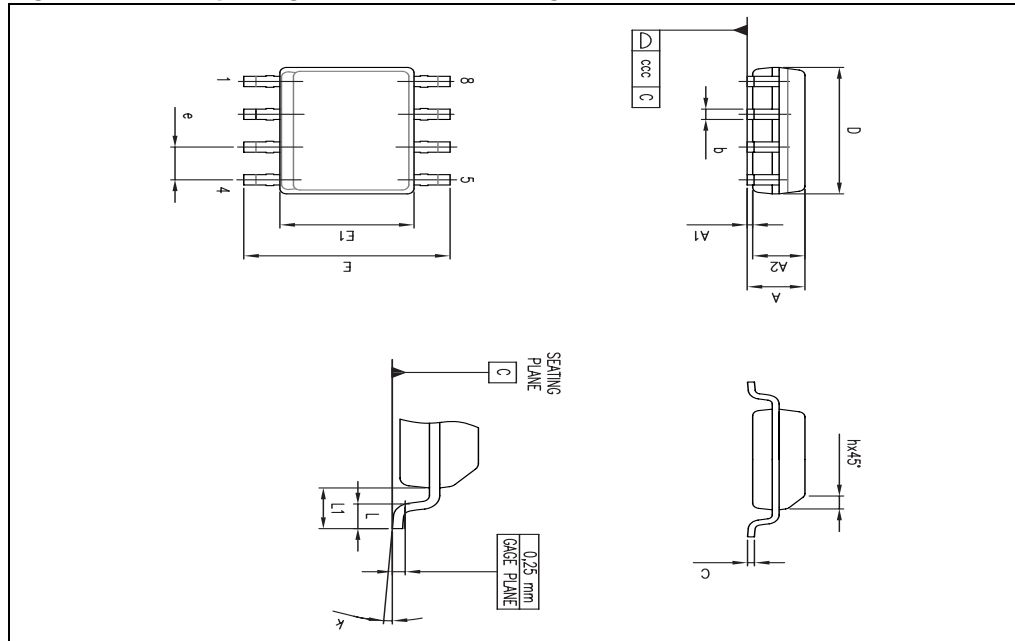

Table 5. SO-8 package mechanical data

| Ref. | Dimensions | | | | | |
|------|-------------|------|------|--------|-------|-------|
| | Millimeters | | | Inches | | |
| | Min. | Typ. | Max. | Min. | Typ. | Max. |
| A | | | 1.75 | | | 0.069 |
| A1 | 0.10 | | 0.25 | 0.004 | | 0.010 |
| A2 | 1.25 | | | 0.049 | | |
| b | 0.28 | | 0.48 | 0.011 | | 0.019 |
| c | 0.17 | | 0.23 | 0.007 | | 0.010 |
| D | 4.80 | 4.90 | 5.00 | 0.189 | 0.193 | 0.197 |
| E | 5.80 | 6.00 | 6.20 | 0.228 | 0.236 | 0.244 |
| E1 | 3.80 | 3.90 | 4.00 | 0.150 | 0.154 | 0.157 |
| e | | 1.27 | | | 0.050 | |
| h | 0.25 | | 0.50 | 0.010 | | 0.020 |
| L | 0.40 | | 1.27 | 0.016 | | 0.050 |
| L1 | | 1.04 | | | 0.040 | |
| k | 1° | | 8° | 1° | | 8° |
| ccc | | | 0.10 | | | 0.004 |

7 Ordering information

Table 6. Order codes

| Order code | Temperature range | Package | Packing | Marking |
|-------------------|-------------------|---------|------------------------|---------|
| LF253N | -40°C, +105°C | DIP8 | Tube | LF253N |
| LF253D LF253DT | | SO-8 | Tube or Tape & reel | 253 |
| LF353N | 0°C, +70°C | DIP8 | Tube | LF353N |
| LF353D LF353DT | | SO-8 | Tube or Tape & reel | 353 |

8 Revision history

Table 7. Document revision history

| Date | Revision | Changes |
|-------------|----------|--|
| 01-Mar-2001 | 1 | Initial release. |
| 08-Sep-2008 | 2 | Updated document format. Removed information concerning military temperature range (LF153). Added L1 parameter dimensions in Table 5: SO-8 package mechanical data . |
| 25-Mar-2010 | 3 | Corrected error in Table 6: Order codes : LF253N, LF253D, LF353N and LF353D proposed in tube packing. |

Please Read Carefully:

Information in this document is provided solely in connection with ST products. STMicroelectronics NV and its subsidiaries ("ST") reserve the right to make changes, corrections, modifications or improvements, to this document, and the products and services described herein at any time, without notice.

All ST products are sold pursuant to ST's terms and conditions of sale.

Purchasers are solely responsible for the choice, selection and use of the ST products and services described herein, and ST assumes no liability whatsoever relating to the choice, selection or use of the ST products and services described herein.

No license, express or implied, by estoppel or otherwise, to any intellectual property rights is granted under this document. If any part of this document refers to any third party products or services it shall not be deemed a license grant by ST for the use of such third party products or services, or any intellectual property contained therein or considered as a warranty covering the use in any manner whatsoever of such third party products or services or any intellectual property contained therein.

UNLESS OTHERWISE SET FORTH IN ST'S TERMS AND CONDITIONS OF SALE ST DISCLAIMS ANY EXPRESS OR IMPLIED WARRANTY WITH RESPECT TO THE USE AND/OR SALE OF ST PRODUCTS INCLUDING WITHOUT LIMITATION IMPLIED WARRANTIES OF MERCHANTABILITY, FITNESS FOR A PARTICULAR PURPOSE (AND THEIR EQUIVALENTS UNDER THE LAWS OF ANY JURISDICTION), OR INFRINGEMENT OF ANY PATENT, COPYRIGHT OR OTHER INTELLECTUAL PROPERTY RIGHT.

UNLESS EXPRESSLY APPROVED IN WRITING BY AN AUTHORIZED ST REPRESENTATIVE, ST PRODUCTS ARE NOT RECOMMENDED, AUTHORIZED OR WARRANTED FOR USE IN MILITARY, AIR CRAFT, SPACE, LIFE SAVING, OR LIFE SUSTAINING APPLICATIONS, NOR IN PRODUCTS OR SYSTEMS WHERE FAILURE OR MALFUNCTION MAY RESULT IN PERSONAL INJURY, DEATH, OR SEVERE PROPERTY OR ENVIRONMENTAL DAMAGE. ST PRODUCTS WHICH ARE NOT SPECIFIED AS "AUTOMOTIVE GRADE" MAY ONLY BE USED IN AUTOMOTIVE APPLICATIONS AT USER'S OWN RISK.

Resale of ST products with provisions different from the statements and/or technical features set forth in this document shall immediately void any warranty granted by ST for the ST product or service described herein and shall not create or extend in any manner whatsoever, any liability of ST.

ST and the ST logo are trademarks or registered trademarks of ST in various countries.

Information in this document supersedes and replaces all information previously supplied.

The ST logo is a registered trademark of STMicroelectronics. All other names are the property of their respective owners.

© 2010 STMicroelectronics - All rights reserved

STMicroelectronics group of companies

Australia - Belgium - Brazil - Canada - China - Czech Republic - Finland - France - Germany - Hong Kong - India - Israel - Italy - Japan - Malaysia - Malta - Morocco - Philippines - Singapore - Spain - Sweden - Switzerland - United Kingdom - United States of America

www.st.com

