

FEATURES

- Two channels in small 4 mm × 4 mm LFCSP
- Gain set with 1 resistor per amplifier ($G = 1$ to 10,000)
- Low noise
 - 8 nV/ $\sqrt{\text{Hz}}$ at 1 kHz
 - 0.25 μV p-p (0.1 Hz to 10 Hz)
- High accuracy dc performance (B grade)
 - 60 μV maximum input offset voltage
 - 0.3 $\mu\text{V}/^\circ\text{C}$ maximum input offset drift
 - 1.0 nA maximum input bias current
 - 126 dB minimum CMRR ($G = 100$)
- Excellent ac performance
 - 140 kHz bandwidth ($G = 100$)
 - 13 μs settling time to 0.001%
- Differential output option (single channel)
 - Fully specified
 - Adjustable common-mode output
- Supply range: ± 2.3 V to ± 18 V

APPLICATIONS

- Multichannel data acquisition for
 - ECG and medical instrumentation
 - Industrial process controls
 - Wheatstone bridge sensors
- Differential drives for
 - High resolution input ADCs
 - Remote sensors

GENERAL DESCRIPTION

The AD8222 is a dual-channel, high performance instrumentation amplifier that requires only one external resistor per amplifier to set gains of 1 to 10,000.

The AD8222 is the first dual-instrumentation amplifier in the small 4 mm × 4mm LFCSP. It requires the same board area as a typical single instrumentation amplifier. The smaller package allows a 2× increase in channel density and a lower cost per channel, all with no compromise in performance.

The AD8222 can also be configured as a single-channel, differential output instrumentation amplifier. Differential outputs provide high noise immunity, which can be useful when the output signal must travel through a noisy environment, such as with remote sensors. The configuration can also be used to drive differential input ADCs.

Rev. A

Information furnished by Analog Devices is believed to be accurate and reliable. However, no responsibility is assumed by Analog Devices for its use, nor for any infringements of patents or other rights of third parties that may result from its use. Specifications subject to change without notice. No license is granted by implication or otherwise under any patent or patent rights of Analog Devices. Trademarks and registered trademarks are the property of their respective owners.

FUNCTIONAL BLOCK DIAGRAM

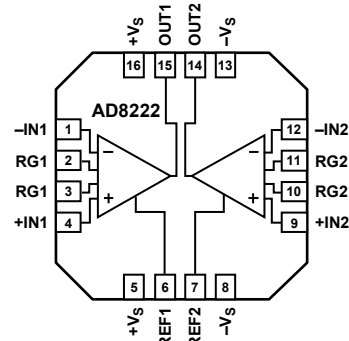

Figure 1. 4 mm × 4 mm LFCSP

Table 1. Instrumentation Amplifiers by Category¹

| General Purpose | Zero Drift | Military Grade | Low Power | High Speed PGA |
|------------------------|------------------------|-----------------------|------------------------|------------------------|
| AD8220 | AD8231 | AD620 | AD8235 | AD8250 |
| AD8221 | AD8290 | AD621 | AD8236 | AD8251 |
| AD8222 | AD8293 | AD524 | AD627 | AD8253 |
| AD8224 | AD8553 | AD526 | AD623 | |
| AD8228 | AD8556 | AD624 | AD8223 | |
| AD8295 | AD8557 | | AD8226 | |
| | | | AD8227 | |

¹ See www.analog.com for the latest selection of instrumentation amplifiers.

The AD8222 maintains a minimum CMRR of 80 dB to 4 kHz for all grades at $G = 1$. High CMRR over frequency allows the AD8222 to reject wideband interference and line harmonics, greatly simplifying filter requirements. The AD8222 also has a typical CMRR drift over temperature of just 0.07 $\mu\text{V}/\text{V}/^\circ\text{C}$ at $G = 1$.

The AD8222 operates on both single and dual supplies and only requires 2.2 mA maximum supply current for both amplifiers. It is specified over the industrial temperature range of -40°C to $+85^\circ\text{C}$ and is fully RoHS compliant.

For a single-channel version, see the [AD8221](#).

TABLE OF CONTENTS

| | | | |
|--|----|---------------------------------------|----|
| Features | 1 | Package Considerations..... | 16 |
| Applications..... | 1 | Layout | 16 |
| Functional Block Diagram | 1 | Input Bias Current Return Path | 17 |
| General Description | 1 | Input Protection | 18 |
| Revision History | 2 | RF Interference | 18 |
| Specifications..... | 3 | Common-Mode Input Voltage Range | 18 |
| Absolute Maximum Ratings..... | 6 | Applications Information | 19 |
| Thermal Resistance | 6 | Differential Output | 19 |
| ESD Caution..... | 6 | Driving a Differential Input ADC..... | 20 |
| Pin Configuration and Function Descriptions..... | 7 | Precision Strain Gage..... | 20 |
| Typical Performance Characteristics | 8 | Driving Cabling..... | 21 |
| Theory of Operation | 15 | Outline Dimensions | 22 |
| Amplifier Architecture | 15 | Ordering Guide | 23 |
| Gain Selection | 15 | | |
| Reference Terminal | 16 | | |

REVISION HISTORY

2/10—Rev. 0 to Rev. A

| | |
|--|-----------|
| Added LFCSP_VQ, CP-16-13 Package..... | Universal |
| Changes to Features Section and Table 1 | 1 |
| Changed V_{IN+} to V_{+IN} , V_{IN-} to V_{-IN} , and T to T_A Throughout..... | 3 |
| Change to Reference Input Parameter, Table 2..... | 4 |
| Changed Output Short-Circuit Current to Output Short-Circuit Duration, Table 5 | 6 |
| Changes to Thermal Resistance Section and Table 6..... | 6 |
| Changes to Figure 2..... | 7 |
| Changes to Figure 19..... | 10 |
| Changes to Figure 43..... | 14 |

| | |
|---|----|
| Changes to Reference Terminal Section, Figure 45, and Package Considerations Section..... | 16 |
| Deleted Thermal Pad Section | 16 |
| Added Package Without Thermal Pad and Package with Thermal Pad Sections | 16 |
| Changes to Figure 46..... | 17 |
| Deleted Solder Wash Section | 17 |
| Changes to RFI and Antialiasing Filter Section | 20 |
| Updated Outline Dimensions | 22 |
| Changes to Ordering Guide | 23 |

7/06—Revision 0: Initial Version

SPECIFICATIONS

$V_S = \pm 15\text{ V}$, $V_{REF} = 0\text{ V}$, $T_A = 25^\circ\text{C}$, $G = 1$, $R_L = 2\text{ k}\Omega$, unless otherwise noted.

Table 2. Single-Ended and Differential¹ Output Configuration

| Parameter | Conditions | A Grade | | | B Grade | | | Unit |
|------------------------------------|--|---------|------|-----|---------|------|-----|--------------------------------|
| | | Min | Typ | Max | Min | Typ | Max | |
| COMMON-MODE REJECTION RATIO (CMRR) | $V_{CM} = -10\text{ V to }+10\text{ V}$ | | | | | | | |
| CMRR DC to 60 Hz | 1 k Ω source imbalance | | | | | | | |
| G = 1 | | 80 | | | 86 | | | dB |
| G = 10 | | 100 | | | 106 | | | dB |
| G = 100 | | 120 | | | 126 | | | dB |
| G = 1000 | | 130 | | | 140 | | | dB |
| CMRR at 4 kHz | | | | | | | | |
| G = 1 | | 80 | | | 80 | | | dB |
| G = 10 | | 90 | | | 100 | | | dB |
| G = 100 | | 100 | | | 110 | | | dB |
| G = 1000 | | 100 | | | 110 | | | dB |
| CMRR Drift | $T_A = -40^\circ\text{C to }+85^\circ\text{C}$, $G = 1$ | | 0.07 | | | 0.07 | | $\mu\text{V/V}/^\circ\text{C}$ |
| NOISE | | | | | | | | |
| Voltage Noise, 1 kHz | RTI noise = $\sqrt{(e_{NI}^2 + (e_{NO}/G)^2)}$ | | | | | | | |
| Input Voltage Noise, e_{NI} | $V_{+IN}, V_{-IN}, V_{REF} = 0\text{ V}$ | | | 8 | | 8 | | nV/ $\sqrt{\text{Hz}}$ |
| Output Voltage Noise, e_{NO} | $V_{+IN}, V_{-IN}, V_{REF} = 0\text{ V}$ | | | 75 | | 75 | | nV/ $\sqrt{\text{Hz}}$ |
| RTI | $f = 0.1\text{ Hz to }10\text{ Hz}$ | | | | | | | |
| G = 1 | | | 2 | | | 2 | | $\mu\text{V p-p}$ |
| G = 10 | | | 0.5 | | | 0.5 | | $\mu\text{V p-p}$ |
| G = 100 to 1000 | | | 0.25 | | | 0.25 | | $\mu\text{V p-p}$ |
| Current Noise | $f = 1\text{ kHz}$ | | 40 | | | 40 | | fA/ $\sqrt{\text{Hz}}$ |
| | $f = 0.1\text{ Hz to }10\text{ Hz}$ | | 6 | | | 6 | | pA p-p |
| VOLTAGE OFFSET | RTI $V_{OS} = (V_{OSI}) + (V_{OSO}/G)$ | | | | | | | |
| Input Offset, V_{OSI} | $V_S = \pm 5\text{ V to } \pm 15\text{ V}$ | | | 120 | | 60 | | μV |
| Over Temperature | $T_A = -40^\circ\text{C to }+85^\circ\text{C}$ | | | 150 | | 80 | | μV |
| Average TC | | | 0.4 | | | 0.3 | | $\mu\text{V}/^\circ\text{C}$ |
| Output Offset, V_{OSO} | $V_S = \pm 5\text{ V to } \pm 15\text{ V}$ | | | 500 | | 350 | | μV |
| Over Temperature | $T_A = -40^\circ\text{C to }+85^\circ\text{C}$ | | | 0.8 | | 0.5 | | mV |
| Average TC | | | 9 | | | 5 | | $\mu\text{V}/^\circ\text{C}$ |
| Offset RTI vs. Supply (PSR) | $V_S = \pm 2.3\text{ V to } \pm 18\text{ V}$ | | | | | | | |
| G = 1 | | 90 | 110 | | 94 | 110 | | dB |
| G = 10 | | 110 | 120 | | 114 | 130 | | dB |
| G = 100 | | 124 | 130 | | 130 | 140 | | dB |
| G = 1000 | | 130 | 140 | | 140 | 150 | | dB |
| INPUT CURRENT (PER CHANNEL) | | | | | | | | |
| Input Bias Current, I_{BIAS} | | | 0.5 | 2.0 | | 0.2 | 1.0 | nA |
| Over Temperature | $T_A = -40^\circ\text{C to }+85^\circ\text{C}$ | | | 3.0 | | | 1.5 | nA |
| Average TC | | | 1 | | | 1 | | pA/ $^\circ\text{C}$ |
| Input Offset Current, I_{OFFSET} | | | 0.2 | 1 | | 0.1 | 0.5 | nA |
| Over Temperature | $T_A = -40^\circ\text{C to }+85^\circ\text{C}$ | | | 1.5 | | | 0.6 | nA |
| Average TC | | | 1 | | | 0.5 | 2 | pA/ $^\circ\text{C}$ |

AD8222

| Parameter | Conditions | A Grade | | | B Grade | | | Unit | |
|--|---|--------------|--------------|--------------|--------------|--------------|--------------|-------------------------|-----|
| | | Min | Typ | Max | Min | Typ | Max | | |
| REFERENCE INPUT | | | | | | | | | |
| R_{IN} | $V_{+IN}, V_{-IN}, V_{REF} = 0\text{ V}$ | | 20 | | | 20 | | k Ω | |
| I_{IN} | | | 50 | 60 | | 50 | 60 | μA | |
| Voltage Range | | | $-V_S$ | | $+V_S$ | $-V_S$ | | $+V_S$ | V |
| Reference Gain to Output | | | | 1 | | | 1 | | V/V |
| Reference Gain Error | | | | 0.01 | | | 0.01 | | % |
| GAIN | | | | | | | | | |
| Gain Range | $G = 1 + (49.4\text{ k}\Omega/R_G)$ | 1 | | 10000 | 1 | | 10000 | V/V | |
| Gain Error | $V_{OUT} \pm 10\text{ V}$ | | | | | | | | |
| G = 1 | | | | 0.05 | | | 0.02 | % | |
| G = 10 | | | | 0.3 | | | 0.15 | % | |
| G = 100 | | | | 0.3 | | | 0.15 | % | |
| G = 1000 | | | | 0.3 | | | 0.15 | % | |
| Gain Nonlinearity | $V_{OUT} = -10\text{ V to }+10\text{ V}$ | | | | | | | | |
| G = 1 | | | 3 | 10 | | 1 | 5 | ppm | |
| G = 10 | | | 7 | 20 | | 7 | 20 | ppm | |
| G = 100 | | | 7 | 20 | | 7 | 20 | ppm | |
| Gain vs. Temperature | | | | | | | | | |
| G = 1 | | | 3 | 10 | | 2 | 5 | ppm/ $^{\circ}\text{C}$ | |
| G > 1 ² | | | | -50 | | | -50 | ppm/ $^{\circ}\text{C}$ | |
| INPUT | | | | | | | | | |
| Input Impedance | | | | | | | | | |
| Differential | | | 100 2 | | | 100 2 | | G Ω pF | |
| Common Mode | | | 100 2 | | | 100 2 | | G Ω pF | |
| Input Operating Voltage Range ³ | $V_S = \pm 2.3\text{ V to } \pm 5\text{ V}$ $T_A = -40^{\circ}\text{C to } +85^{\circ}\text{C}$ | $-V_S + 1.9$ | | $+V_S - 1.1$ | $-V_S + 1.9$ | | $+V_S - 1.1$ | V | |
| Over Temperature | | | $-V_S + 2.0$ | | $+V_S - 1.2$ | $-V_S + 2.0$ | | $+V_S - 1.2$ | V |
| Input Operating Voltage Range ³ | $V_S = \pm 5\text{ V to } \pm 18\text{ V}$ $T_A = -40^{\circ}\text{C to } +85^{\circ}\text{C}$ | $-V_S + 1.9$ | | $+V_S - 1.2$ | $-V_S + 1.9$ | | $+V_S - 1.2$ | V | |
| Over Temperature | | | $-V_S + 2.0$ | | $+V_S - 1.2$ | $-V_S + 2.0$ | | $+V_S - 1.2$ | V |
| OUTPUT | | | | | | | | | |
| Output Swing | $R_L = 10\text{ k}\Omega$ $V_S = \pm 2.3\text{ V to } \pm 5\text{ V}$ $T_A = -40^{\circ}\text{C to } +85^{\circ}\text{C}$ | $-V_S + 1.1$ | | $+V_S - 1.2$ | $-V_S + 1.1$ | | $+V_S - 1.2$ | V | |
| Over Temperature | | | $-V_S + 1.4$ | | $+V_S - 1.3$ | $-V_S + 1.4$ | | $+V_S - 1.3$ | V |
| Output Swing | $V_S = \pm 5\text{ V to } \pm 18\text{ V}$ $T_A = -40^{\circ}\text{C to } +85^{\circ}\text{C}$ | $-V_S + 1.2$ | | $+V_S - 1.4$ | $-V_S + 1.2$ | | $+V_S - 1.4$ | V | |
| Over Temperature | | | $-V_S + 1.6$ | | $+V_S - 1.5$ | $-V_S + 1.6$ | | $+V_S - 1.5$ | V |
| Short-Circuit Current | | | 18 | | | 18 | | mA | |
| POWER SUPPLY | | | | | | | | | |
| Operating Range | $V_S = \pm 2.3\text{ V to } \pm 18\text{ V}$ | ± 2.3 | | ± 18 | ± 2.3 | | ± 18 | V | |
| Quiescent Current (per Amplifier) | $T_A = -40^{\circ}\text{C to } +85^{\circ}\text{C}$ | | 0.9 | 1.1 | | 0.9 | 1.1 | mA | |
| Over Temperature | | | | 1 | 1.2 | | 1 | 1.2 | mA |
| TEMPERATURE RANGE | | | | | | | | | |
| Specified Performance | | -40 | | +85 | -40 | | +85 | $^{\circ}\text{C}$ | |
| Operational ⁴ | | -40 | | +125 | -40 | | +125 | $^{\circ}\text{C}$ | |

¹ Refers to differential configuration shown in Figure 49.

² Does not include the effects of external resistor, R_G .

³ One input grounded. $G = 1$.

⁴ See the Typical Performance Characteristics section for expected operation between 85°C and 125°C .

$V_S = \pm 15\text{ V}$, $V_{REF} = 0\text{ V}$, $T_A = 25^\circ\text{C}$, $R_L = 2\text{ k}\Omega$, unless otherwise noted.

Table 3. Single-Ended Output Configuration—Dynamic Performance (Both Amplifiers)

| Parameter | Conditions | A Grade | | | B Grade | | | Unit |
|------------------------------|---------------|---------|------|-----|---------|-----|-----|------------------|
| | | Min | Typ | Max | Min | Typ | Max | |
| DYNAMIC RESPONSE | | | | | | | | |
| Small Signal –3 dB Bandwidth | | | | | | | | |
| G = 1 | | | 1200 | | 1200 | | | kHz |
| G = 10 | | | 750 | | 750 | | | kHz |
| G = 100 | | | 140 | | 140 | | | kHz |
| G = 1000 | | | 15 | | 15 | | | kHz |
| Settling Time 0.01% | 10 V step | | | | | | | |
| G = 1 to 100 | | | 10 | | 10 | | | μs |
| G = 1000 | | | 80 | | 80 | | | μs |
| Settling Time 0.001% | 10 V step | | | | | | | |
| G = 1 to 100 | | | 13 | | 13 | | | μs |
| G = 1000 | | | 110 | | 110 | | | μs |
| Slew Rate | G = 1 | 1.5 | 2 | | 1.5 | 2 | | V/ μs |
| | G = 5 to 1000 | 2 | 2.5 | | 2 | 2.5 | | V/ μs |

Table 4. Differential Output Configuration¹—Dynamic Performance

| Parameter | Conditions | A Grade | | | B Grade | | | Unit |
|------------------------------|---------------|---------|------|-----|---------|-----|-----|------------------|
| | | Min | Typ | Max | Min | Typ | Max | |
| DYNAMIC RESPONSE | | | | | | | | |
| Small Signal –3 dB Bandwidth | | | | | | | | |
| G = 1 | | | 1000 | | 1000 | | | kHz |
| G = 10 | | | 650 | | 650 | | | kHz |
| G = 100 | | | 140 | | 140 | | | kHz |
| G = 1000 | | | 15 | | 15 | | | kHz |
| Settling Time 0.01% | 10 V step | | | | | | | |
| G = 1 to 100 | | | 15 | | 15 | | | μs |
| G = 1000 | | | 80 | | 80 | | | μs |
| Settling Time 0.001% | 10 V step | | | | | | | |
| G = 1 to 100 | | | 18 | | 18 | | | μs |
| G = 1000 | | | 110 | | 110 | | | μs |
| Slew Rate | G = 1 | 1.5 | 2 | | 1.5 | 2 | | V/ μs |
| | G = 5 to 1000 | 2 | 2.5 | | 2 | 2.5 | | V/ μs |

¹ Refers to differential configuration shown in Figure 49.

ABSOLUTE MAXIMUM RATINGS

Table 5.

| Parameter | Rating |
|--|---|
| Supply Voltage | ± 18 V |
| Output Short-Circuit Current Duration | Indefinite |
| Input Voltage (Common Mode) | $\pm V_S$ |
| Differential Input Voltage | $\pm V_S$ |
| Storage Temperature Range | -65°C to $+130^{\circ}\text{C}$ |
| Operational Temperature Range | -40°C to $+125^{\circ}\text{C}$ |
| Package Glass Transition Temperature (T_G) | 130°C |
| ESD | |
| Human Body Model | 1 kV |
| Charge Device Model | 1 kV |

Stresses above those listed under Absolute Maximum Ratings may cause permanent damage to the device. This is a stress rating only; functional operation of the device at these or any other conditions above those indicated in the operational section of this specification is not implied. Exposure to absolute maximum rating conditions may affect device reliability.

THERMAL RESISTANCE

Table 6.

| Package | θ_{JA} | Unit |
|-------------------------------------|---------------|-----------------------------|
| CP-16-19: LFCSP Without Thermal Pad | 86 | $^{\circ}\text{C}/\text{W}$ |
| CP-16-13: LFCSP with Thermal Pad | 48 | $^{\circ}\text{C}/\text{W}$ |

The θ_{JA} values in Table 6 assume a 4-layer JEDEC standard board. For the LFCSP with thermal pad, it is assumed that the thermal pad is soldered to a landing on the PCB board, with the landing thermally connected to a heat dissipating power plane. θ_{JC} at the exposed pad is $4.4^{\circ}\text{C}/\text{W}$.

Maximum Power Dissipation

The maximum safe power dissipation for the AD8222 is limited by the associated rise in junction temperature (T_J) on the die. At approximately 130°C , which is the glass transition temperature, the plastic changes its properties. Even temporarily exceeding this temperature limit may change the stresses that the package exerts on the die, permanently shifting the parametric performance of the amplifiers. Exceeding a temperature of 130°C for an extended period can result in a loss of functionality.

ESD CAUTION



ESD (electrostatic discharge) sensitive device. Charged devices and circuit boards can discharge without detection. Although this product features patented or proprietary protection circuitry, damage may occur on devices subjected to high energy ESD. Therefore, proper ESD precautions should be taken to avoid performance degradation or loss of functionality.

PIN CONFIGURATION AND FUNCTION DESCRIPTIONS

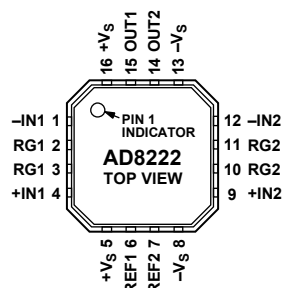

NOTES

1. THE AD8222 COMES IN TWO PACKAGE TYPES—EACH A 16 LEAD 4mm × 4mm LFCSP. ONE PACKAGE TYPE HAS AN EXPOSED THERMAL PAD, WHICH IS CONNECTED TO $-V_s$. THE OTHER PACKAGE TYPE DOES NOT EXPOSE THE THERMAL PAD. SEE THE PACKAGE CONSIDERATIONS SECTION FOR MORE INFORMATION.

05947-002

Figure 2. Pin Configuration

Table 7. Pin Function Descriptions

| Pin No | Mnemonic | Description |
|--------|----------|---------------------------|
| 1 | -IN1 | Negative Input In-Amp 1 |
| 2 | RG1 | Gain Resistor In-Amp 1 |
| 3 | RG1 | Gain Resistor In-Amp 1 |
| 4 | +IN1 | Positive Input In-Amp 1 |
| 5 | +Vs | Positive Supply |
| 6 | REF1 | Reference Adjust In-Amp 1 |
| 7 | REF2 | Reference Adjust In-Amp 2 |
| 8 | -Vs | Negative Supply |
| 9 | +IN2 | Positive Input In-Amp 2 |
| 10 | RG2 | Gain Resistor In-Amp 2 |
| 11 | RG2 | Gain Resistor In-Amp 2 |
| 12 | -IN2 | Negative Input In-Amp 2 |
| 13 | -Vs | Negative Supply |
| 14 | OUT2 | Output In-Amp 2 |
| 15 | OUT1 | Output In-Amp 1 |
| 16 | +Vs | Positive Supply |

TYPICAL PERFORMANCE CHARACTERISTICS

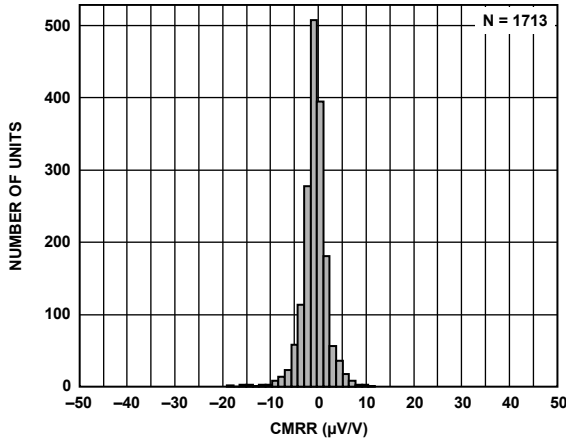

Figure 3. Typical Distribution for CMRR (G = 1)

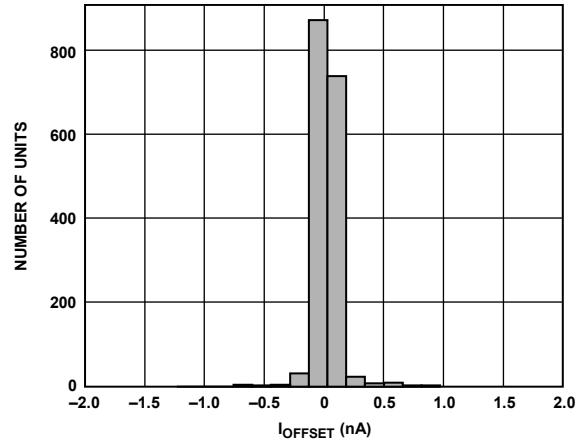

Figure 6. Typical Distribution of Input Offset Current

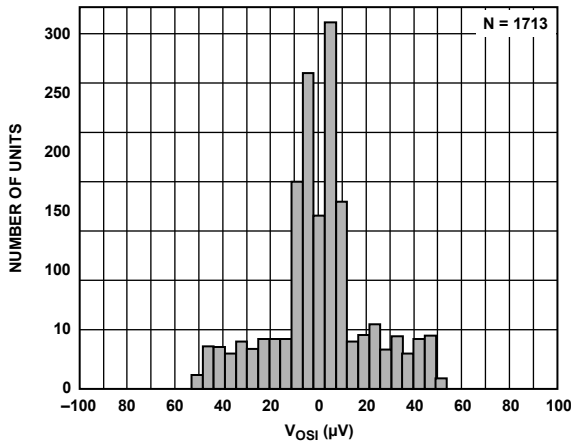

Figure 4. Typical Distribution of Input Offset Voltage

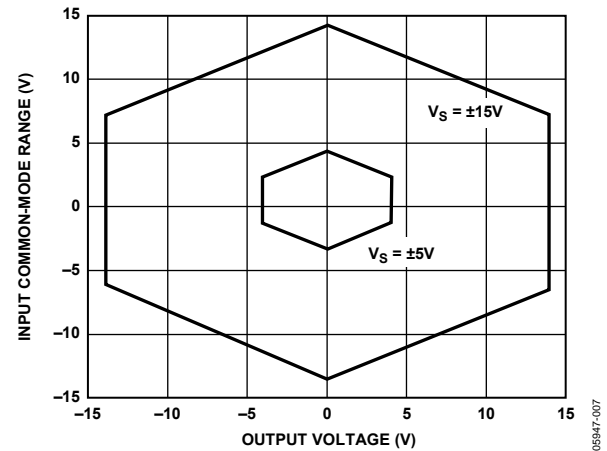

Figure 7. Input Common-Mode Range vs. Output Voltage, G = 1

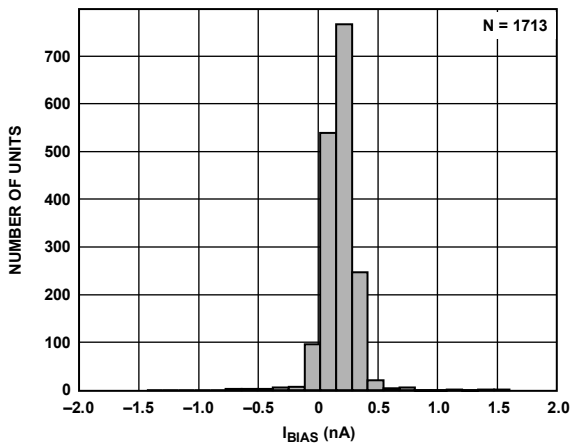

Figure 5. Typical Distribution of Input Bias Current

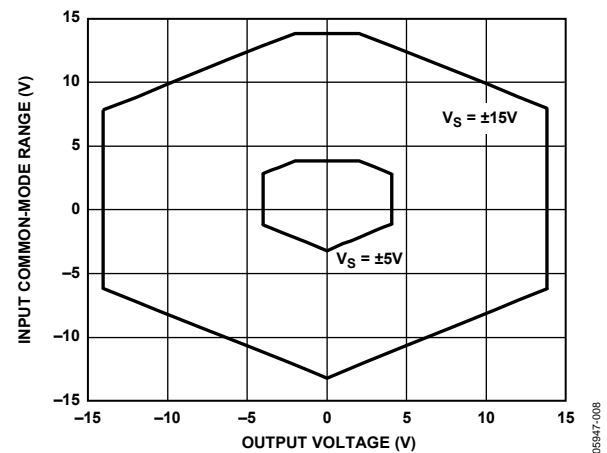

Figure 8. Input Common-Mode Range vs. Output Voltage, G = 100

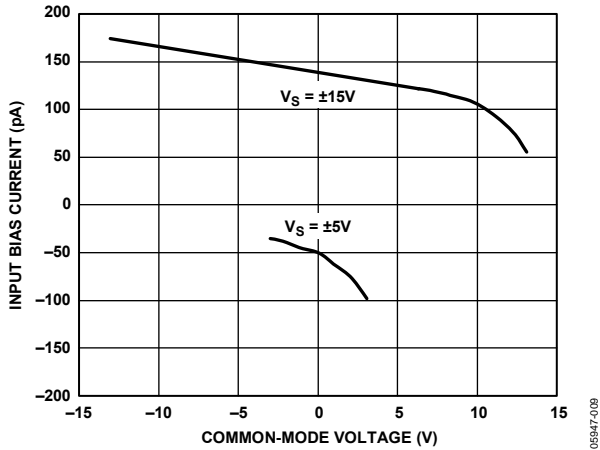

Figure 9. I_{BIAS} vs. Common-Mode Voltage

05947-009

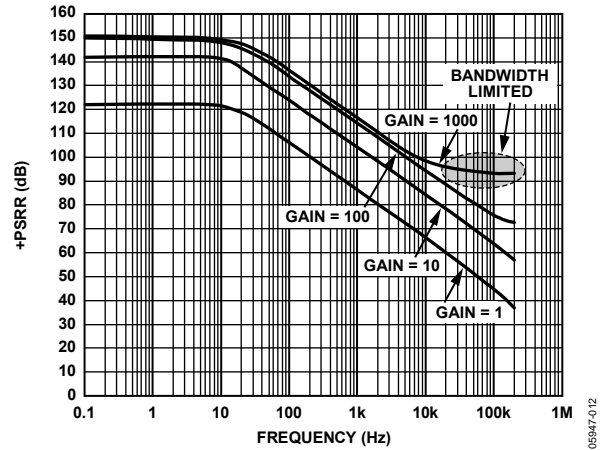

Figure 12. Positive PSRR vs. Frequency, RTI ($G = 1$ to 1000)

05947-012

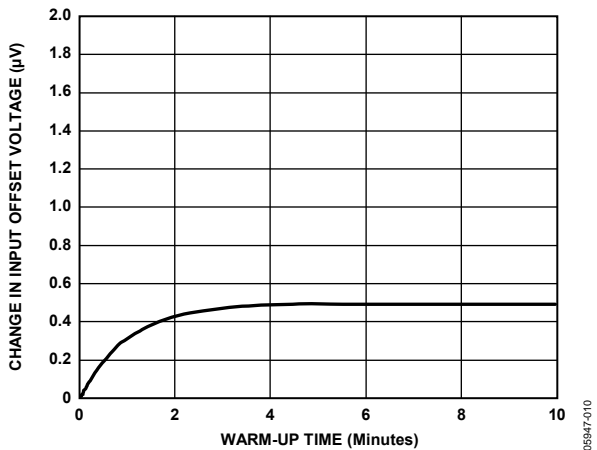

Figure 10. Change in Input Offset Voltage vs. Warm-Up Time

05947-010

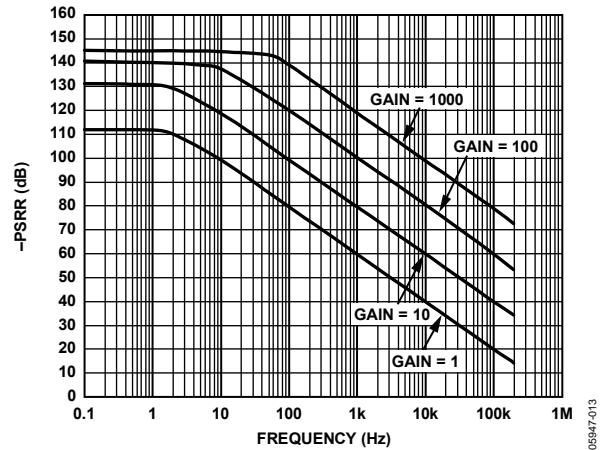

Figure 13. Negative PSRR vs. Frequency, RTI ($G = 1$ to 1000)

05947-013

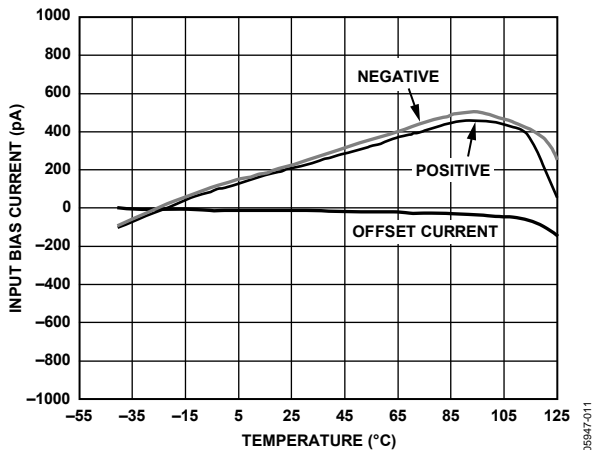

Figure 11. Input Bias Current and Offset Current vs. Temperature

05947-011

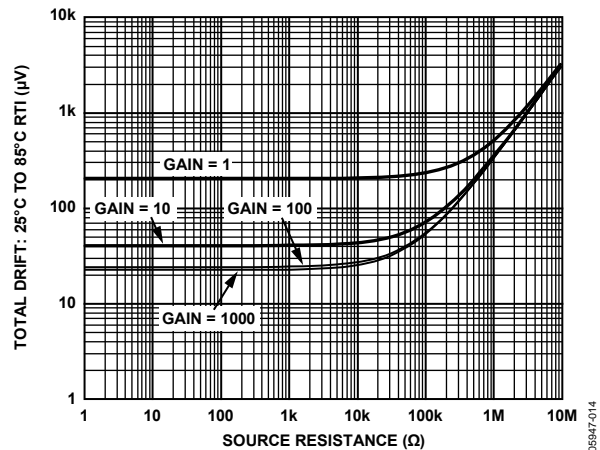

Figure 14. Total Drift vs. Source Resistance

05947-014

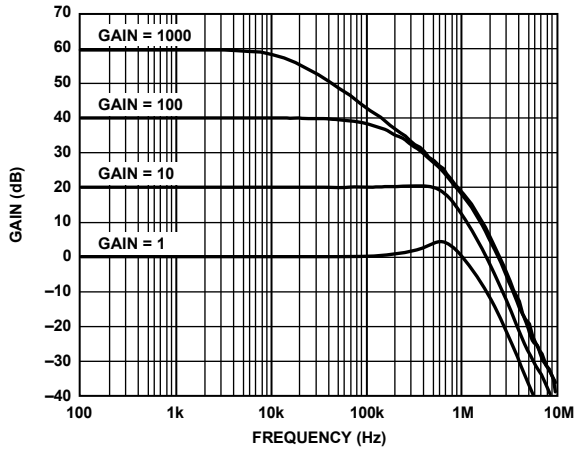

Figure 15. Gain vs. Frequency

05947-015

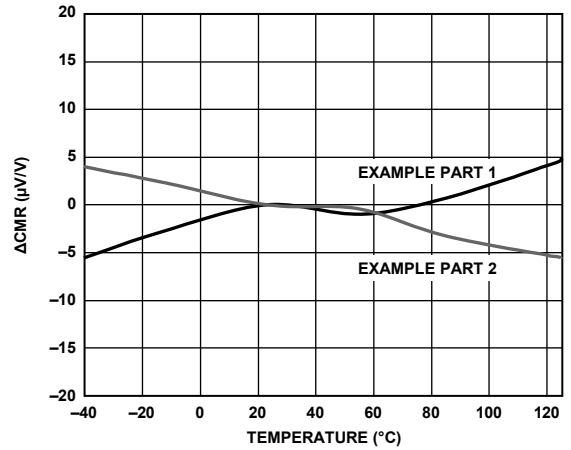

Figure 18. Δ CMR vs. Temperature, $G = 1$

05947-018

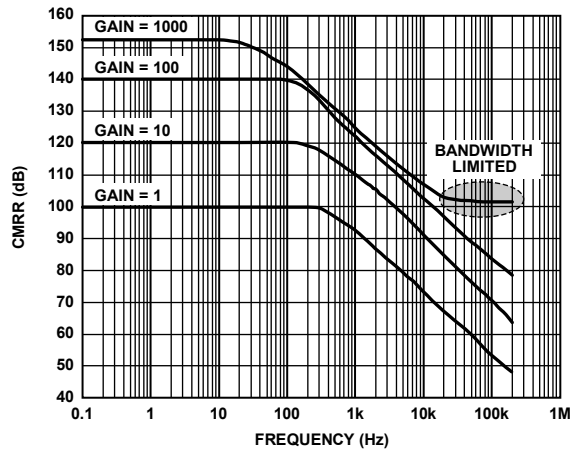

Figure 16. CMRR vs. Frequency, RTI

05947-016

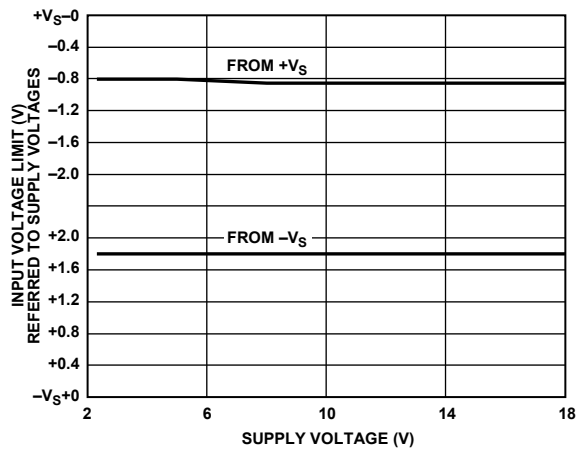

Figure 19. Input Voltage Limit vs. Supply Voltage, $G = 1$

05947-019

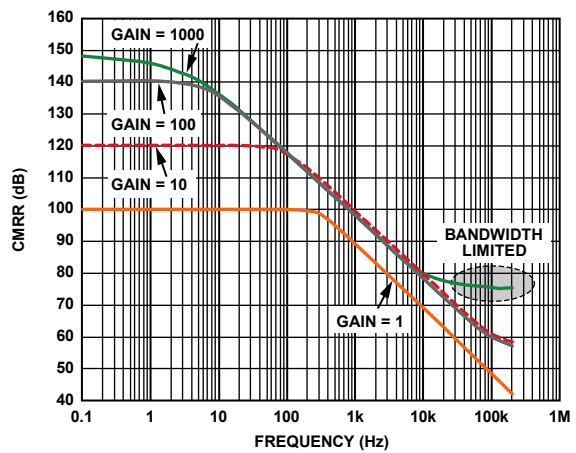

Figure 17. CMRR vs. Frequency, RTI, 1 k Ω Source Imbalance

05947-017

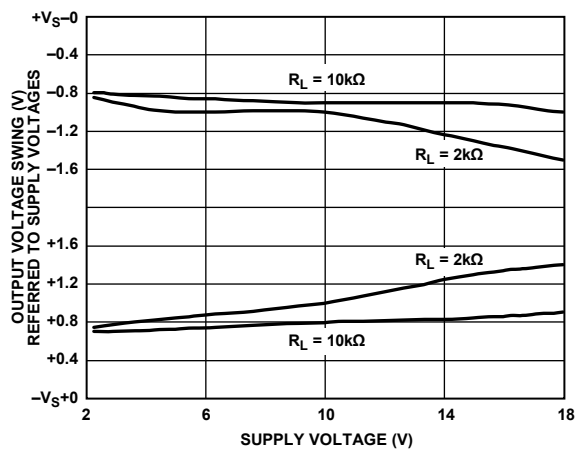

Figure 20. Output Voltage Swing vs. Supply Voltage, $G = 1$

05947-020

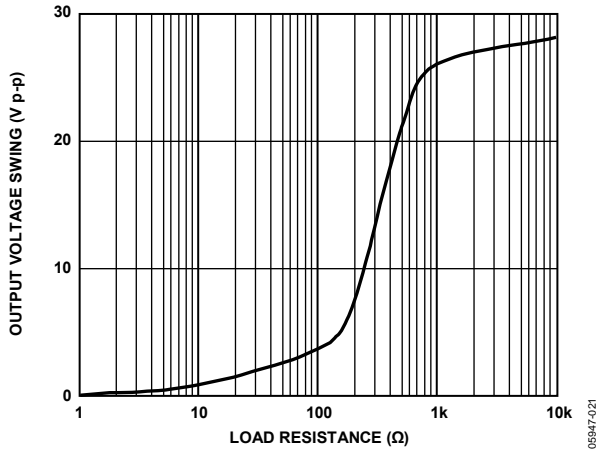

Figure 21. Output Voltage Swing vs. Load Resistance

05947-021

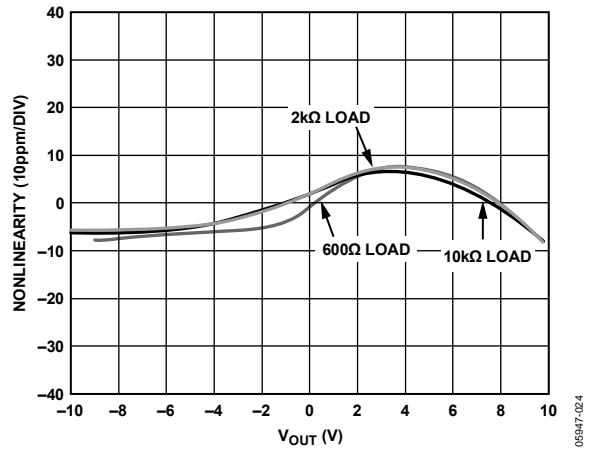

Figure 24. Gain Nonlinearity, $G = 100$

05947-024

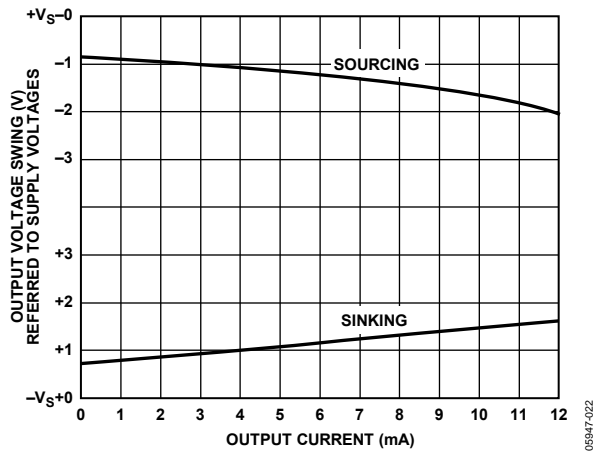

Figure 22. Output Voltage Swing vs. Output Current, $G = 1$

05947-022

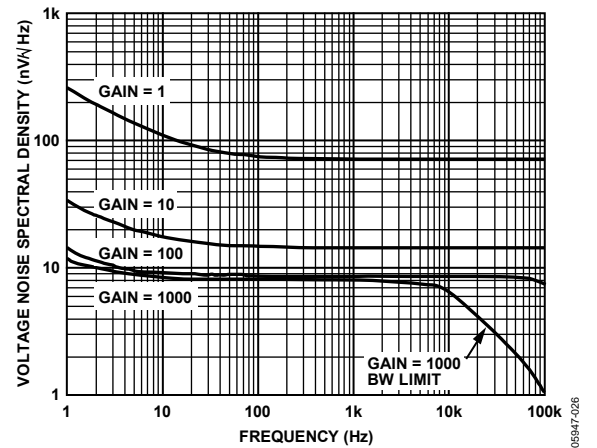

Figure 25. Voltage Noise Spectral Density vs. Frequency ($G = 1$ to 1000)

05947-026

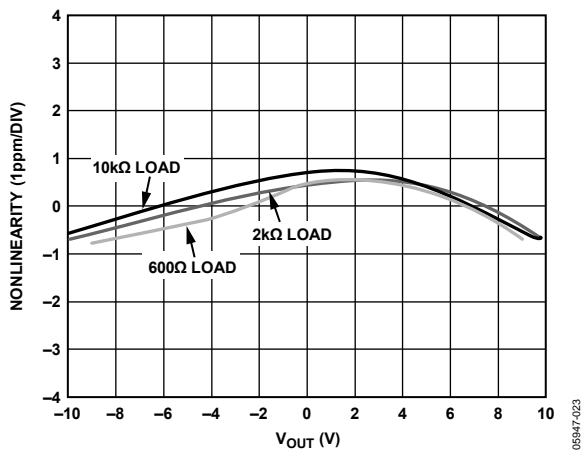

Figure 23. Gain Nonlinearity, $G = 1$

05947-023

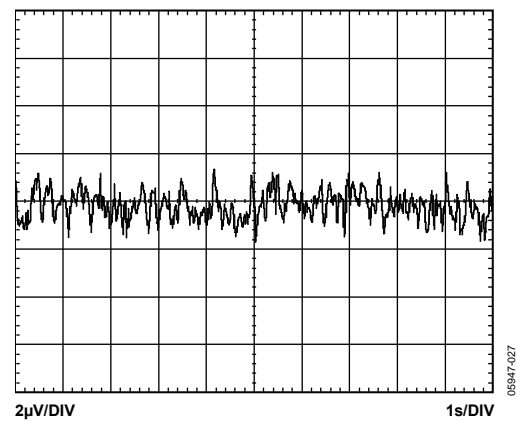

Figure 26. 0.1 Hz to 10 Hz RTI Voltage Noise ($G = 1$)

05947-027

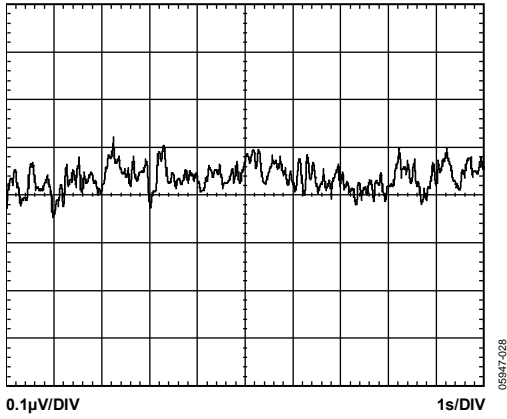

Figure 27. 0.1 Hz to 10 Hz RTI Voltage Noise ($G = 1000$)

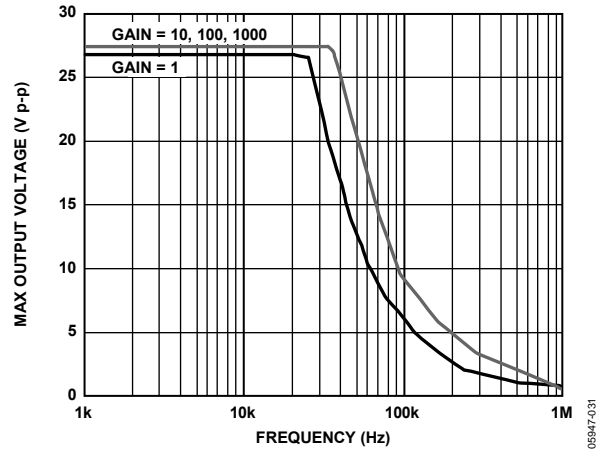

Figure 30. Large Signal Frequency Response

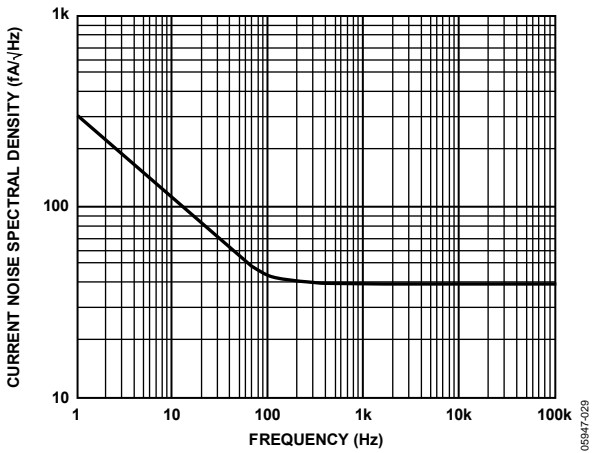

Figure 28. Current Noise Spectral Density vs. Frequency

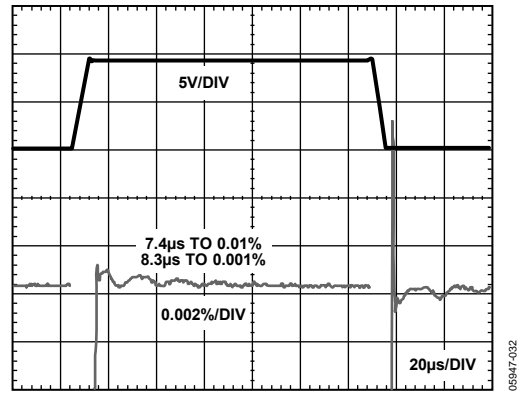

Figure 31. Large Signal Pulse Response and Settling Time ($G = 1$)

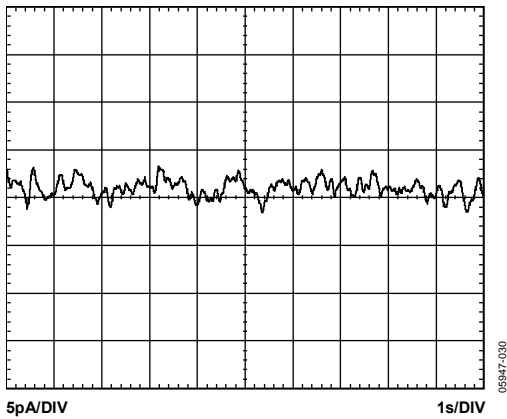

Figure 29. 0.1 Hz to 10 Hz Current Noise

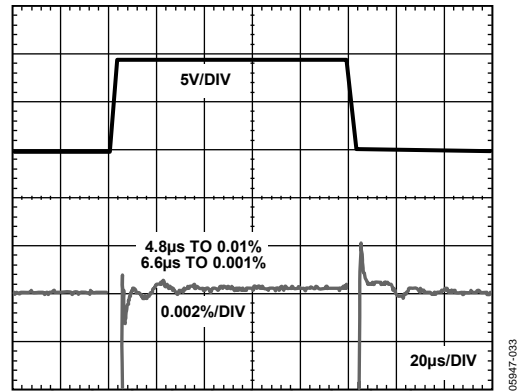

Figure 32. Large Signal Pulse Response and Settling ($G = 10$)

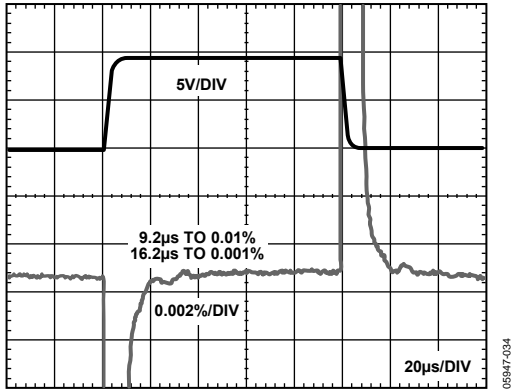

Figure 33. Large Signal Pulse Response and Settling Time ($G = 100$)

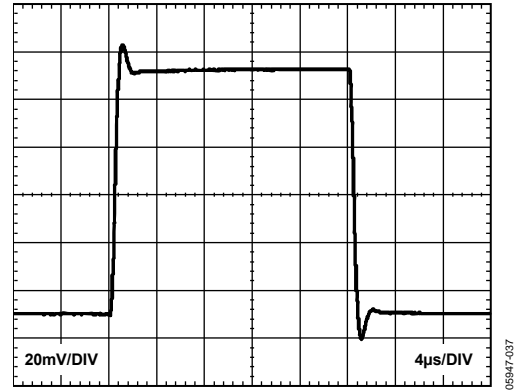

Figure 36. Small Signal Response, $G = 10$, $R_L = 2\text{ k}\Omega$, $C_L = 100\text{ pF}$

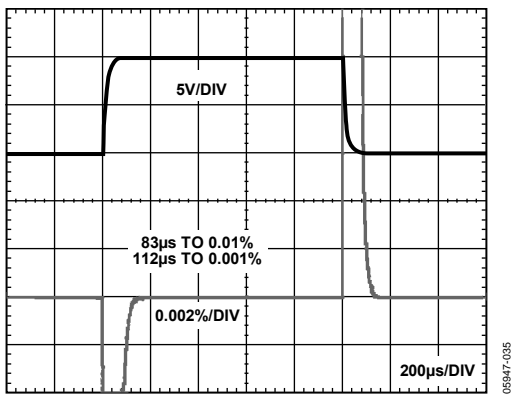

Figure 34. Large Signal Pulse Response and Settling Time ($G = 1000$)

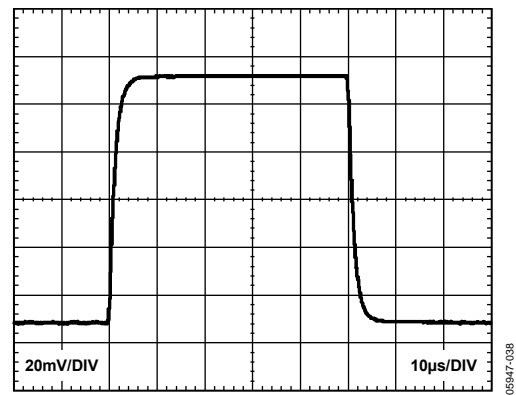

Figure 37. Small Signal Response, $G = 100$, $R_L = 2\text{ k}\Omega$, $C_L = 100\text{ pF}$

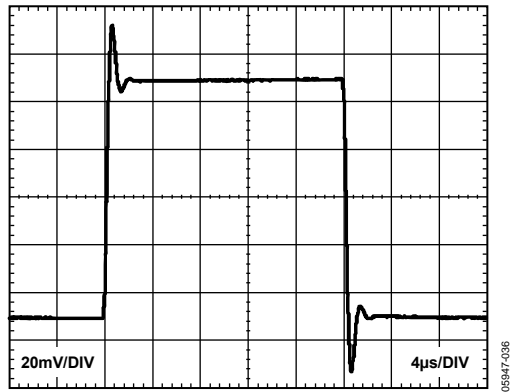

Figure 35. Small Signal Response, $G = 1$, $R_L = 2\text{ k}\Omega$, $C_L = 100\text{ pF}$

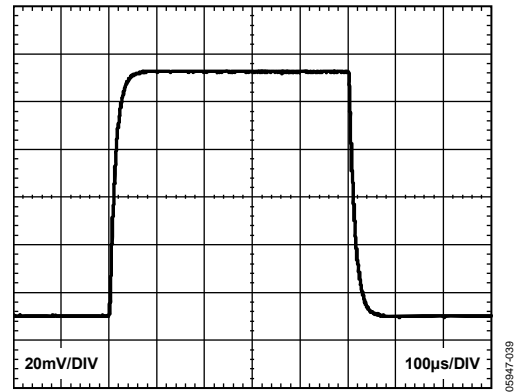

Figure 38. Small Signal Response, $G = 1000$, $R_L = 2\text{ k}\Omega$, $C_L = 100\text{ pF}$

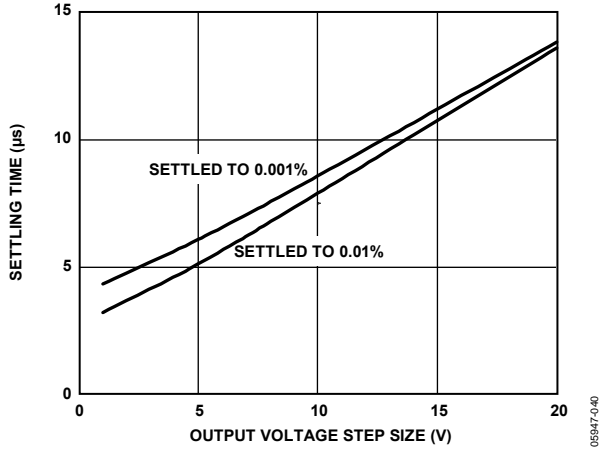

Figure 39. Settling Time vs. Step Size ($G = 1$)

05947-040

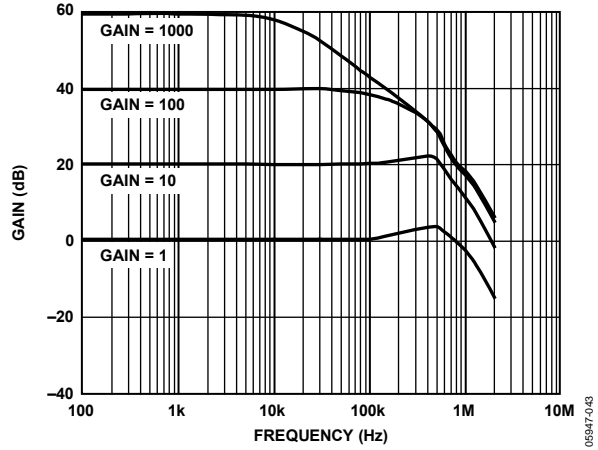

Figure 42. Differential Output Configuration: Gain vs. Frequency

05947-043

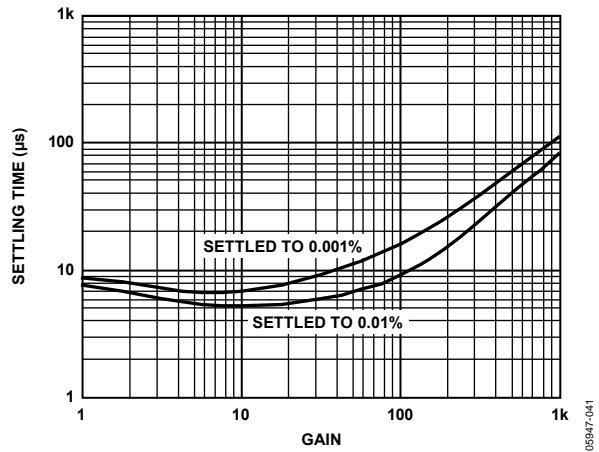

Figure 40. Settling Time vs. Gain for a 10 V Step

05947-041

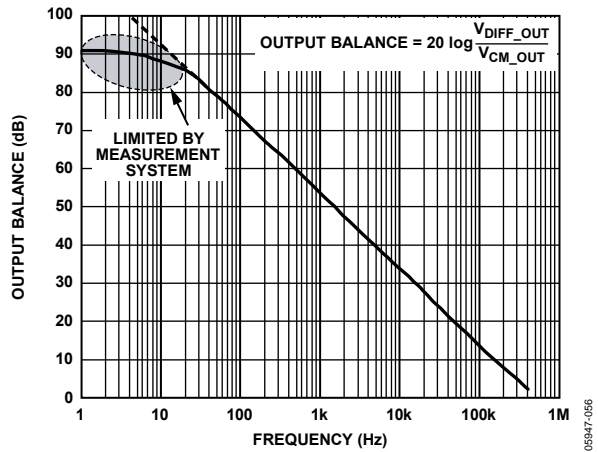

Figure 43. Differential Output Configuration: Output Balance vs. Frequency

05947-056

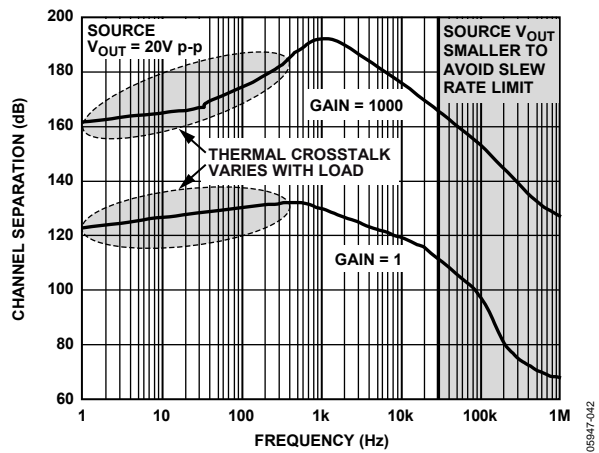

Figure 41. Channel Separation vs. Frequency, $R_L = 2\text{ k}\Omega$, Source Channel at $G = 1$

05947-042

THEORY OF OPERATION

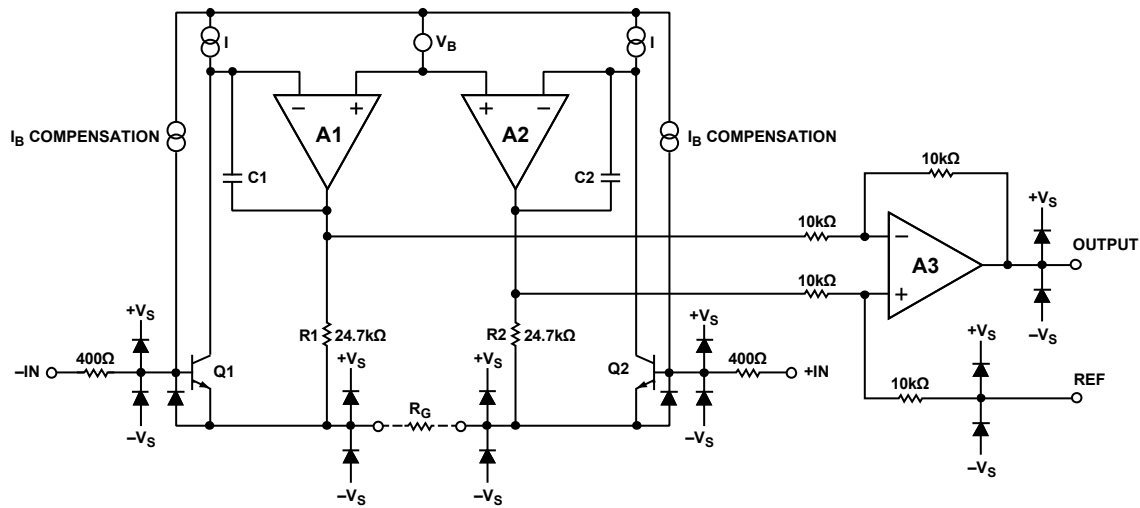

Figure 44. Simplified Schematic

03947-045

AMPLIFIER ARCHITECTURE

The two instrumentation amplifiers of the AD8222 are based on the classic 3-op-amp topology. Figure 44 shows a simplified schematic of one of the amplifiers. The input transistors, Q1 and Q2, are biased at a fixed current. Any differential input signal forces the output voltages of A1 and A2 to change so that the differential voltage also appears across R_G . The current that flows through R_G must also flow through R1 and R2, resulting in a precisely amplified version of the differential input signal between the outputs of A1 and A2. Topologically, Q1 + A1 + R1 and Q2 + A2 + R2 can be viewed as precision current feedback amplifiers. The common-mode signal and the amplified differential signal are applied to a difference amplifier that rejects the common-mode voltage. The difference amplifier employs innovations that result in low output offset voltage as well as low output offset voltage drift.

Because the input amplifiers employ a current feedback architecture, the gain-bandwidth product of the AD8222 increases with gain, resulting in a system that does not suffer from the expected bandwidth loss of voltage feedback architectures at higher gains.

The transfer function of the AD8222 is

$$V_{OUT} = G(V_{+IN} - V_{-IN}) + V_{REF}$$

where:

$$G = 1 + \frac{49.4 \text{ k}\Omega}{R_G}$$

GAIN SELECTION

Placing a resistor across the R_G terminals sets the gain of the AD8222, which can be calculated by referring to Table 8 or by using the following gain equation:

$$R_G = \frac{49.4 \text{ k}\Omega}{G - 1}$$

Table 8. Gains Achieved Using 1% Resistors

| 1% Standard Table Value of R_G (Ω) | Calculated Gain |
|---|-----------------|
| 49.9 k | 1.990 |
| 12.4 k | 4.984 |
| 5.49 k | 9.998 |
| 2.61 k | 19.93 |
| 1.00 k | 50.40 |
| 499 | 100.0 |
| 249 | 199.4 |
| 100 | 495.0 |
| 49.9 | 991.0 |

The AD8222 defaults to $G = 1$ when no gain resistor is used. The tolerance and gain drift of the R_G resistor should be added to the AD8222's specifications to determine the total gain accuracy of the system. When the gain resistor is not used, gain error and gain drift are kept to a minimum.

AD8222

REFERENCE TERMINAL

The output voltage of an AD8222 channel is developed with respect to the potential on the corresponding reference terminal. Typically the reference terminal is connected to ground, but it can also be driven with a voltage to offset the output signal. For example, connect a voltage to the reference terminal to level-shift the output so that the AD8222 can drive a single-supply ADC. Both REF1 and REF2 are protected with ESD diodes and should not exceed either $+V_S$ or $-V_S$ by more than 0.3 V.

For best performance, source impedance to a reference terminal should be kept below $1\ \Omega$. As shown in Figure 44, the reference terminal is at one end of a $10\ \text{k}\Omega$ resistor. Additional impedance at the reference terminal adds to this $10\ \text{k}\Omega$ resistor and results in amplification of the signal connected to the positive input. The amplification from the additional R_{REF} can be computed by

$$\frac{2(10\ \text{k}\Omega + R_{REF})}{20\ \text{k}\Omega + R_{REF}}$$

Only the positive signal path is amplified; the negative path is unaffected. This uneven amplification degrades the amplifier's CMRR.

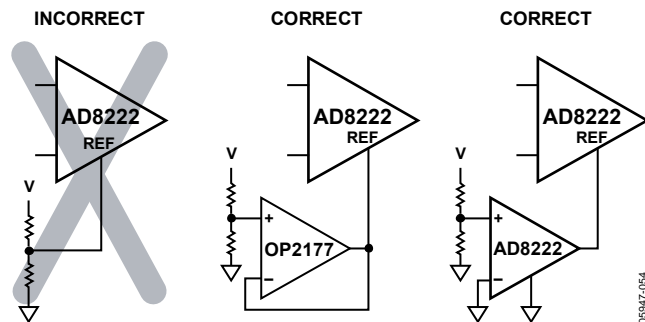

Figure 45. Driving the Reference Pin

PACKAGE CONSIDERATIONS

The AD8222 comes in a $4\ \text{mm} \times 4\ \text{mm}$ LFCSP. Beware of blindly copying the footprint from another $4\ \text{mm} \times 4\ \text{mm}$ LFCSP part; the landing pattern may be different. Refer to the Outline Dimensions section to verify that the PCB symbol has the correct dimensions.

The AD8222 comes in two package varieties, both with and without a thermal pad.

Package Without Thermal Pad

The AD8222 ships with a package that does not include a thermal pad; it is the preferred package for the AD8222. Unlike chip scale packages where the pad limits routing capability, the AD8222 package allows routes and vias directly underneath the chip, so that the full space savings of the small LFCSP can be realized.

Although the package has no metal in the center of the part, the manufacturing process does leave a very small section of exposed metal at each of the package corners, shown in Figure 55 in the

Outline Dimensions section. This metal is connected to $-V_S$ through the part. Because of a possibility of a short, vias should not be placed underneath this exposed metal.

Package with Thermal Pad

This package is included primarily for legacy reasons. Because the AD8222 dissipates so little power, there is little need for the thermal pad.

The thermal pad is connected internally to $-V_S$. The pad can either be left unsoldered, soldered to an otherwise unconnected PCB landing, or soldered to a landing connected to the negative supply rail ($-V_S$). If pin compatibility with the AD8224 is desired, the pad should not be electrically connected to any net, including $-V_S$.

The solder process can leave flux and other contaminants on the board. When these contaminants are between the AD8222 leads and thermal pad, they can create leakage paths that are larger than the AD8222's bias currents. A thorough washing process removes these contaminants and restores the AD8222's excellent bias current performance.

LAYOUT

The AD8222 is a high precision device. To ensure optimum performance at the PC board level, care must be taken in the design of the board layout. The AD8222 pinout is arranged in a logical manner to aid in this task.

Common-Mode Rejection Over Frequency

The AD8222 has a higher CMRR over frequency than typical in-amps, which gives it greater immunity to disturbances, such as line noise and its associated harmonics. A well-implemented layout is required to maintain this high performance. Input source impedances should be matched closely. Source resistance should be placed close to the inputs so that it interacts with as little parasitic capacitance as possible.

Parasitics at the RGx pins can also affect CMRR over frequency. The PCB should be laid out so that the parasitic capacitances at each pin match. Traces from the gain setting resistor to the RGx pins should be kept short to minimize parasitic inductance.

Reference

Errors introduced at the reference terminal feed directly to the output. Care should be taken to tie REF to the appropriate local ground.

Power Supplies

A stable dc voltage should be used to power the instrumentation amplifier. Noise on the supply pins can adversely affect performance.

The AD8222 has two positive supply pins (Pin 5 and Pin 16) and two negative supply pins (Pin 8 and Pin 13). Although the part functions with only one pin from each supply pair connected,

both pins should be connected for specified performance and optimum reliability.

The AD8222 should be decoupled with 0.1 μF bypass capacitors, one for each supply. The positive supply decoupling capacitor should be placed near Pin 16, and the negative supply decoupling capacitor should be placed near Pin 8. Each supply should also be decoupled with a 10 μF tantalum capacitor. The tantalum capacitor can be placed further away from the AD8222 and can generally be shared by other precision integrated circuits. Figure 46 shows an example layout.

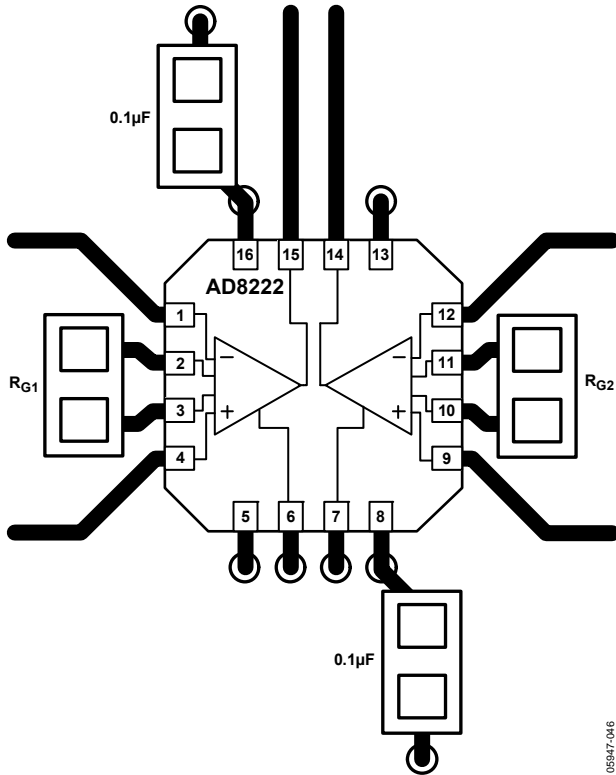

Figure 46. Example Layout

INPUT BIAS CURRENT RETURN PATH

The input bias current of the AD8222 must have a return path to common. When the source, such as a thermocouple, cannot provide a return current path, one should be created, as shown in Figure 47.

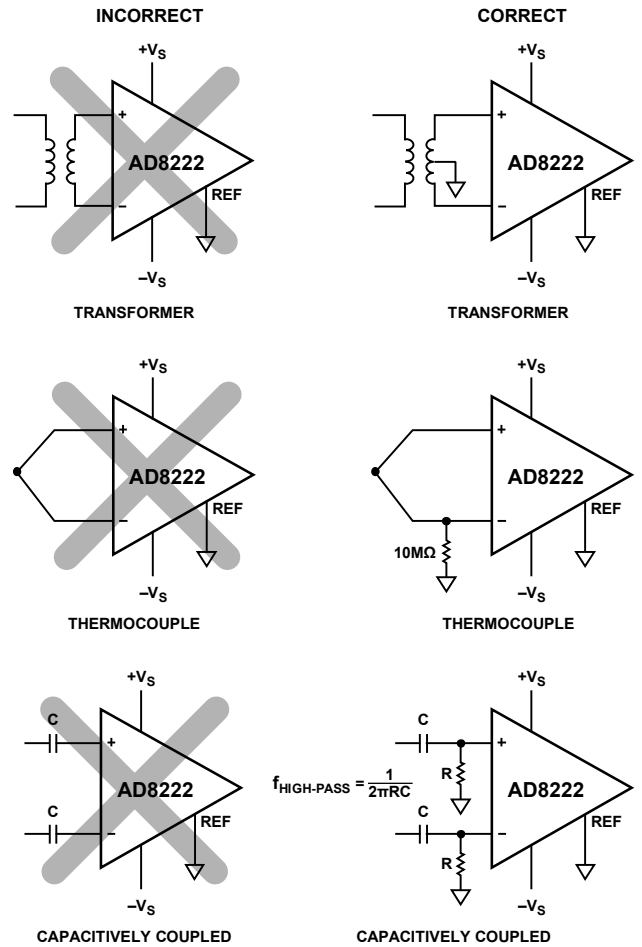

Figure 47. Creating an I_{BIAS} Path

AD8222

INPUT PROTECTION

All terminals of the AD8222 are protected against ESD (1 kV, human body model). In addition, the input structure allows for dc overload conditions of about 2.5 V beyond the supplies.

Input Voltages Beyond the Rails

For larger input voltages, an external resistor should be used in series with each input to limit current during overload conditions. The AD8222 can safely handle a continuous 6 mA current. The limiting resistor can be computed from

$$R_{LIMIT} \geq \frac{V_{IN} - V_{SUPPLY}}{6 \text{ mA}} - 400 \Omega$$

For applications in which the AD8222 encounters extreme overload voltages, such as cardiac defibrillators, external series resistors and low leakage diode clamps, such as the BAV199L, the FJH1100, or the SP720, should be used.

Differential Input Voltages at High Gains

When operating at high gain, large differential input voltages can cause more than 6 mA of current to flow into the inputs. This condition occurs when the differential voltage exceeds the following critical voltage:

$$V_{CRITICAL} = (400 + R_G) \times (6 \text{ mA})$$

This is true for differential voltages of either polarity.

The maximum allowed differential voltage can be increased by adding an input protection resistor in series with each input. The value of each protection resistor should be

$$R_{PROTECT} = (V_{DIFF_MAX} - V_{CRITICAL})/6 \text{ mA}$$

RF INTERFERENCE

RF rectification is often a problem when amplifiers are used in applications where there are strong RF signals. The disturbance can appear as a small dc offset voltage. High frequency signals can be filtered with a low-pass, RC network placed at the input of the instrumentation amplifier, as shown in Figure 48. The filter limits the input signal bandwidth according to the following relationship:

$$FilterFreq_{diff} = \frac{1}{2\pi R(2C_D + C_C)}$$

$$FilterFreq_{CM} = \frac{1}{2\pi R \times C_C}$$

where $C_D \geq 10C_C$.

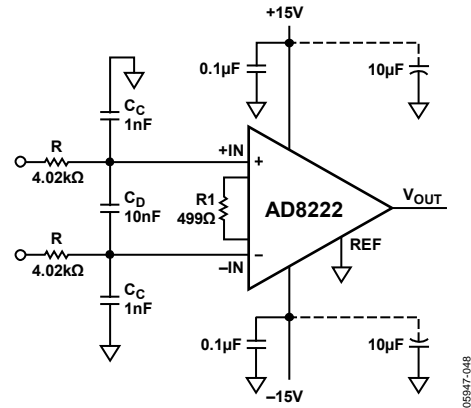

Figure 48. RFI Suppression

Figure 48 shows an example where the differential filter frequency is approximately 2 kHz, and the common-mode filter frequency is approximately 40 kHz.

Values of R and C_C should be chosen to minimize RFI. Mismatch between the R × C_C at the positive input and the R × C_C at negative input degrades the CMRR of the AD8222. By using a value of C_D 10× larger than the value of C_C, the effect of the mismatch is reduced and performance is improved.

COMMON-MODE INPUT VOLTAGE RANGE

The 3-op-amp architecture of the AD8222 applies gain and then removes the common-mode voltage. Therefore, internal nodes in the AD8222 experience a combination of both the gained signal and the common-mode signal. This combined signal can be limited by the voltage supplies even when the individual input and output signals are not. Figure 7 and Figure 8 show the allowable common-mode input voltage ranges for various output voltages, supply voltages, and gains.

APPLICATIONS INFORMATION

DIFFERENTIAL OUTPUT

The differential configuration of the AD8222 has the same excellent dc precision specifications as the single-ended output configuration and is recommended for applications in the frequency range of dc to 100 kHz.

The circuit configuration is shown in Figure 49. The differential output specifications in Table 2 and Table 4 refer to this configuration only. The circuit includes an RC filter that maintains the stability of the loop.

The transfer function for the differential output is:

$$V_{DIFF_OUT} = V_{+OUT} - V_{-OUT} = (V_{+IN} - V_{-IN}) \times G$$

$$\text{where } G = 1 + \frac{49.4 \text{ k}\Omega}{R_G}$$

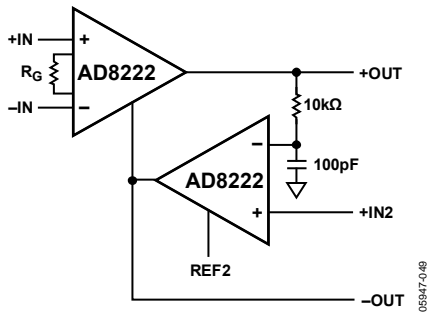

Figure 49. Differential Circuit Schematic

Setting the Common-Mode Voltage

The output common-mode voltage is set by the average of +IN2 and REF2. The transfer function is

$$V_{CM_OUT} = (V_{+OUT} + V_{-OUT})/2 = (V_{+IN2} + V_{REF2})/2$$

+IN2 and REF2 have different properties that allow the reference voltage to be easily set for a wide variety of applications. +IN2 has high impedance but cannot swing to the supply rails of the part. REF2 must be driven with a low impedance but can go 300 mV beyond the supply rails.

A common application sets the common-mode output voltage to the midscale of a differential ADC. In this case, the ADC reference voltage is sent to the +IN2 terminal, and ground is connected to the REF2 terminal. This produces a common-mode output voltage of half the ADC reference voltage.

2-Channel Differential Output Using a Dual Op Amp

Another differential output topology is shown in Figure 50. Instead of a second in-amp, $\frac{1}{2}$ of a dual OP2177 op amp creates the inverted output. Because the OP2177 is packaged in an MSOP, this configuration allows the creation of a dual channel, precision differential output in-amp with little board area.

Errors from the op amp are common to both outputs and are thus common mode. Errors from mismatched resistors also create a common-mode dc offset. Because these errors are common mode, they will likely be rejected by the next device in the signal chain.

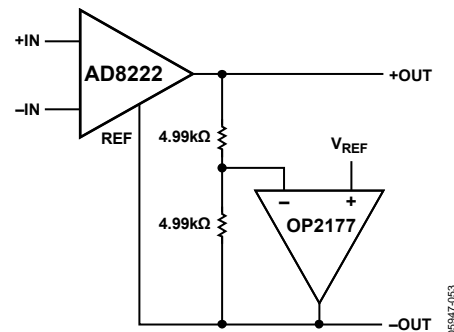

Figure 50. Differential Output Using Op Amp

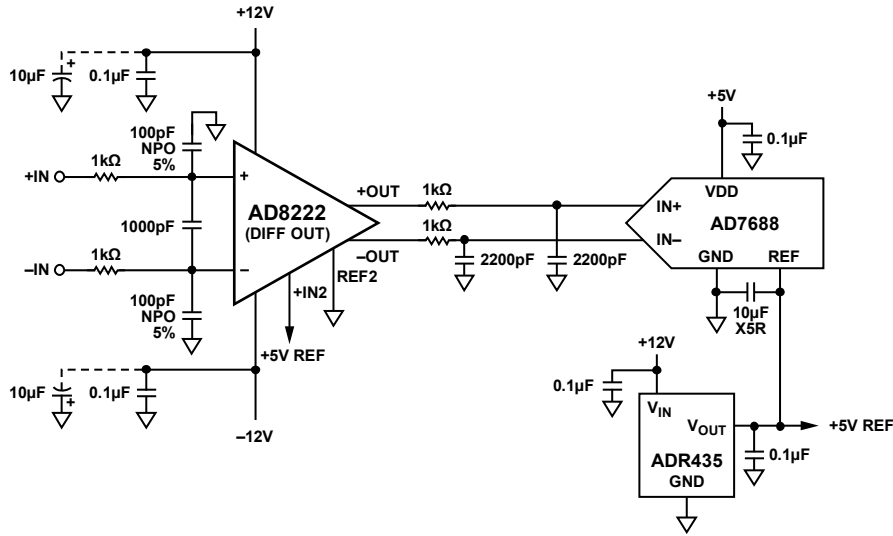

Figure 51. Driving a Differential ADC

DRIVING A DIFFERENTIAL INPUT ADC

The AD8222 can be configured in differential output mode to drive a differential analog-to-digital converter. Figure 51 illustrates several of the concepts.

RFI and Antialiasing Filter

The 1 kΩ resistors, 1000 pF capacitor, and 100 pF capacitors in front of the in-amp form filter circuitry that performs many functions. The 1 kΩ and 100 pF capacitors form common-mode filters that protect the amplifier from incoming radio frequency signals. Without the filtering, these RFI signals can be rectified in the in-amp. The 1 kΩ resistors provide some overvoltage protection. The 1 kΩ resistors and 1000 pF capacitor form a 76 kHz antialiasing filter for the ADC.

Note that the 100 pF capacitors are 5% COG/NPO types. These capacitors match well over time and temperature, which keeps the system CMRR high over frequency.

Second Antialiasing Filter

A 1 kΩ resistor and 2200 pF capacitor are placed between each AD8222 output and ADC input. They create a 72 kHz low-pass filter for another stage of antialiasing protection.

These four elements also improve distortion performance. The 2200 pF capacitor provides charge to the switched capacitor front end of the ADC, and the 1 kΩ resistor shields the AD8222 from driving any sharp current changes. If the application requires a lower frequency antialiasing filter and is distortion sensitive, increase the value of the capacitor rather than the resistor.

The 1 kΩ resistors can also protect an ADC from overvoltages. Because the AD8222 runs on wider supply voltages than a typical ADC, there is a possibility of overdriving the ADC. This is not an issue with a PulsAR® converter, such as the AD7688. Its input can handle a 130 mA overdrive, which is much higher than the short-circuit limit of the AD8222. However, other converters have less robust inputs and may need the added protection.

Reference

The ADR435 supplies a reference voltage to both the ADC and the AD8222. Because REF2 on the AD8222 is grounded, the common-mode output voltage is precisely half the reference voltage, exactly where it needs to be for the ADC.

PRECISION STRAIN GAGE

The low offset and high CMRR over frequency of the AD8222 make it an excellent candidate for both ac and dc bridge measurements. As shown in Figure 52, the bridge can be connected to the inputs of the amplifier directly.

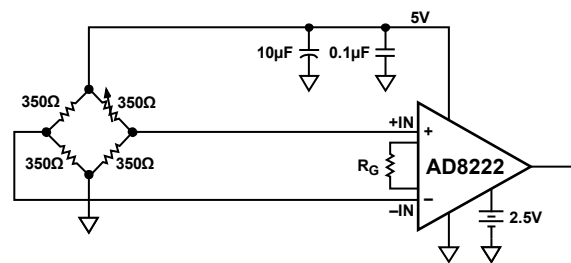

Figure 52. Precision Strain Gauge

DRIVING CABLING

All cables have a certain capacitance per unit length, which varies widely with cable type. The capacitive load from the cable may cause peaking in the AD8222's output response. To reduce the peaking, use a resistor between the AD8222 and the cable. Because cable capacitance and desired output response vary widely, this resistor is best determined empirically. A good starting point is 50 Ω .

The AD8222 operates at a low enough frequency that transmission line effects are rarely an issue; therefore, the resistor need not match the characteristic impedance of the cable.

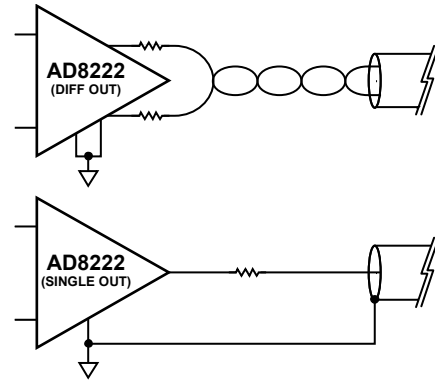
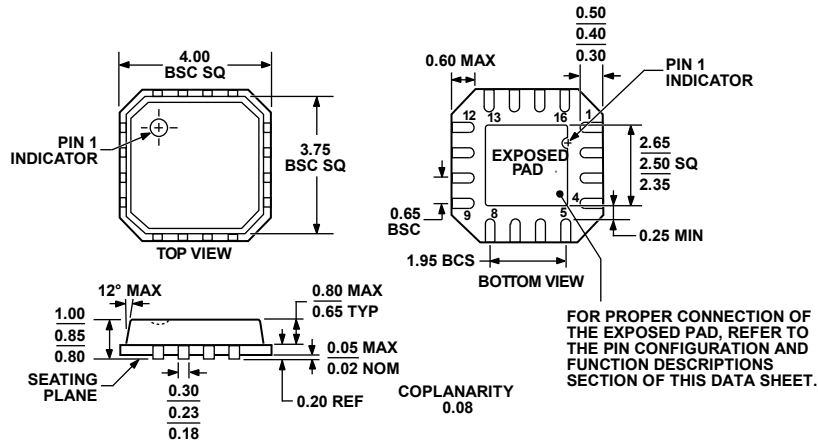

Figure 53. Driving a Cable

05947-052

OUTLINE DIMENSIONS



COMPLIANT TO JEDEC STANDARDS MO-220-VGGC.

Figure 54. 16-Lead Lead Frame Chip Scale Package [LFCSP_VQ]
 4 mm × 4 mm Body, Very Thin Quad
 (CP-16-13)
 Dimensions are shown in millimeters

031005-A

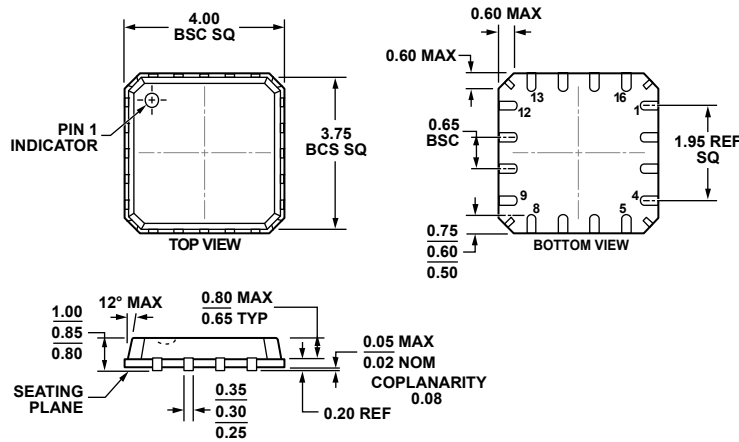

COMPLIANT TO JEDEC STANDARDS MO-263-VBBC

Figure 55. 16-Lead Lead Frame Chip Scale Package [LFCSP_VQ]
 4 mm × 4 mm Body, Very Thin Quad, with Hidden Paddle
 CP-16-19
 Dimensions shown in millimeters

062309-B

ORDERING GUIDE

| Model ¹ | Temperature Range | Product Description | Package Description | Package Option |
|--------------------|-------------------|--|---|----------------|
| AD8222ACPZ-R7 | -40°C to +85°C | Standard Grade with Thermal Pad | 16-Lead Lead Frame Chip Scale Package [LFCSP_VQ], 7" Tape and Reel | CP-16-13 |
| AD8222ACPZ-RL | -40°C to +85°C | Standard Grade with Thermal Pad | 16-Lead Lead Frame Chip Scale Package [LFCSP_VQ], 13" Tape and Reel | CP-16-13 |
| AD8222ACPZ-WP | -40°C to +85°C | Standard Grade with Thermal Pad | 16-Lead Lead Frame Chip Scale Package [LFCSP_VQ], Waffle Pack | CP-16-13 |
| AD8222BCPZ-R7 | -40°C to +85°C | High Performance Grade with Thermal Pad | 16-Lead Lead Frame Chip Scale Package [LFCSP_VQ], 7" Tape and Reel | CP-16-13 |
| AD8222BCPZ-RL | -40°C to +85°C | High Performance Grade with Thermal Pad | 16-Lead Lead Frame Chip Scale Package [LFCSP_VQ], 13" Tape and Reel | CP-16-13 |
| AD8222BCPZ-WP | -40°C to +85°C | High Performance Grade with Thermal Pad | 16-Lead Lead Frame Chip Scale Package [LFCSP_VQ], Waffle Pack | CP-16-13 |
| AD8222HACPZ-R7 | -40°C to +85°C | Standard Grade Without Thermal Pad | 16-Lead Lead Frame Chip Scale Package [LFCSP_VQ], 7" Tape and Reel | CP-16-19 |
| AD8222HACPZ-RL | -40°C to +85°C | Standard Grade Without Thermal Pad | 16-Lead Lead Frame Chip Scale Package [LFCSP_VQ], 13" Tape and Reel | CP-16-19 |
| AD8222HACPZ-WP | -40°C to +85°C | Standard Grade Without Thermal Pad | 16-Lead Lead Frame Chip Scale Package [LFCSP_VQ], Waffle Pack | CP-16-19 |
| AD8222HBCPZ-R7 | -40°C to +85°C | High Performance Grade Without Thermal Pad | 16-Lead Lead Frame Chip Scale Package [LFCSP_VQ], 7" Tape and Reel | CP-16-19 |
| AD8222HBCPZ-RL | -40°C to +85°C | High Performance Grade Without Thermal Pad | 16-Lead Lead Frame Chip Scale Package [LFCSP_VQ], 13" Tape and Reel | CP-16-19 |
| AD8222HBCPZ-WP | -40°C to +85°C | High Performance Grade Without Thermal Pad | 16-Lead Lead Frame Chip Scale Package [LFCSP_VQ], Waffle Pack | CP-16-19 |
| AD8222-EVALZ | | | Evaluation Board | |

¹ Z = RoHS Compliant Part.

AD8222

NOTES