

FEATURES

- Low Noise, 80 nV p-p (0.1 Hz to 10 Hz)**
 $3 \text{ nV}/\sqrt{\text{Hz}} @ 1 \text{ kHz}$
- Low Drift, 0.2 $\mu\text{V}/^\circ\text{C}$**
- High Speed, 17 V/ μs Slew Rate**
63 MHz Gain Bandwidth
- Low Input Offset Voltage, 10 μV**
- Excellent CMRR, 126 dB (Common-Voltage @ 11 V)**
- High Open-Loop Gain, 1.8 Million**
- Replaces 725, OP-07, SE5534 In Gains > 5**
- Available in Die Form**

GENERAL DESCRIPTION

The OP37 provides the same high performance as the OP27, but the design is optimized for circuits with gains greater than five. This design change increases slew rate to 17 V/ μs and gain-bandwidth product to 63 MHz.

The OP37 provides the low offset and drift of the OP07 plus higher speed and lower noise. Offsets down to 25 μV and a maximum drift of 0.6 $\mu\text{V}/^\circ\text{C}$ make the OP37 ideal for precision instrumentation applications. Exceptionally low noise ($e_n = 3.5 \text{ nV}/\sqrt{\text{Hz}}$ @ 10 Hz), a low 1/f noise corner frequency of 2.7 Hz, and the high gain of 1.8 million, allow accurate high-gain amplification of low-level signals.

The low input bias current of 10 nA and offset current of 7 nA are achieved by using a bias-current cancellation circuit. Over the military temperature range this typically holds I_B and I_{OS} to 20 nA and 15 nA respectively.

The output stage has good load driving capability. A guaranteed swing of 10 V into 600 Ω and low output distortion make the OP37 an excellent choice for professional audio applications.

PSRR and CMRR exceed 120 dB. These characteristics, coupled with long-term drift of 0.2 $\mu\text{V}/\text{month}$, allow the circuit designer to achieve performance levels previously attained only by discrete designs.

Low-cost, high-volume production of the OP37 is achieved by using on-chip zener-zap trimming. This reliable and stable offset trimming scheme has proved its effectiveness over many years of production history.

The OP37 brings low-noise instrumentation-type performance to such diverse applications as microphone, tapehead, and RIAA phono preamplifiers, high-speed signal conditioning for data acquisition systems, and wide-bandwidth instrumentation.

PIN CONNECTIONS

8-Lead Hermetic DIP
(Z Suffix)

Epoxy Mini-DIP
(P Suffix)

8-Lead SO
(S Suffix)

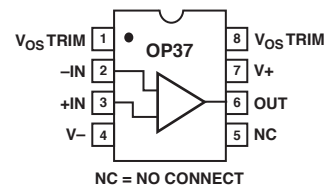

SIMPLIFIED SCHEMATIC

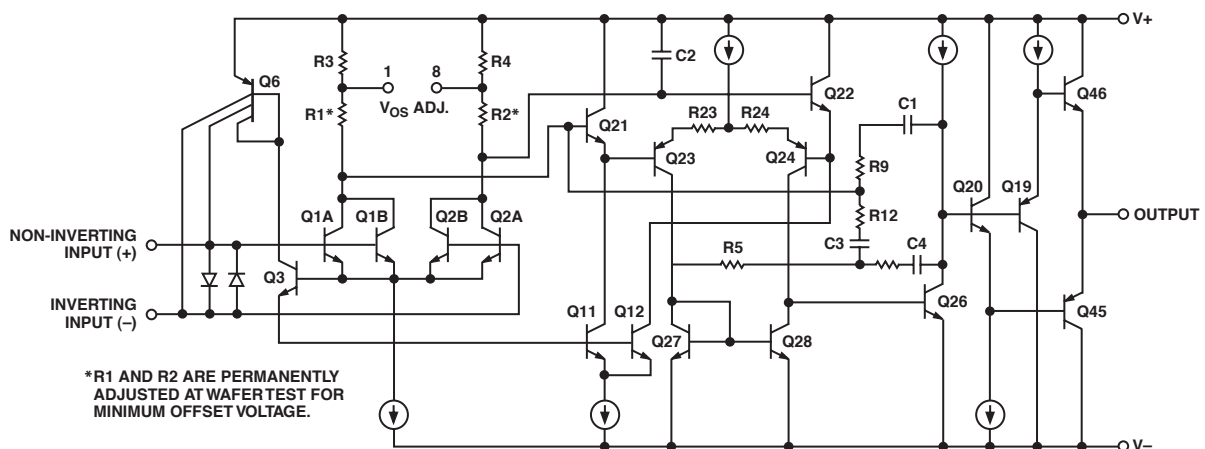

REV. B

Information furnished by Analog Devices is believed to be accurate and reliable. However, no responsibility is assumed by Analog Devices for its use, nor for any infringements of patents or other rights of third parties that may result from its use. No license is granted by implication or otherwise under any patent or patent rights of Analog Devices.

One Technology Way, P.O. Box 9106, Norwood, MA 02062-9106, U.S.A.
 Tel: 781/329-4700 www.analog.com
 Fax: 781/326-8703 © Analog Devices, Inc., 2002

OP37

ABSOLUTE MAXIMUM RATINGS⁴

Supply Voltage	22 V
Internal Voltage (Note 1)	22 V
Output Short-Circuit Duration	Indefinite
Differential Input Voltage (Note 2)	0.7 V
Differential Input Current (Note 2)	25 mA
Storage Temperature Range	-65°C to +150°C
Operating Temperature Range	
OP37A	-55°C to +125°C
OP37E (Z)	-25°C to +85°C
OP37E, OP-37F (P)	0°C to 70°C
OP37G (P, S, Z)	-40°C to +85°C
Lead Temperature Range (Soldering, 60 sec)	300°C
Junction Temperature	-45°C to +150°C

Package Type	θ_{JA}^3	θ_{JC}	Unit
8-Lead Hermetic DIP (Z)	148	16	°C/W
8-Lead Plastic DIP (P)	103	43	°C/W
8-Lead SO (S)	158	43	°C/W

NOTES

¹For supply voltages less than 22 V, the absolute maximum input voltage is equal to the supply voltage.

²The OP37's inputs are protected by back-to-back diodes. Current limiting resistors are not used in order to achieve low noise. If differential input voltage exceeds 0.7 V, the input Current should be limited to 25 mA.

³ θ_{JA} is specified for worst case mounting conditions, i.e., θ_{JA} is specified for device in socket for TO, CerDIP, P-DIP, and LCC packages; θ_{JA} is specified for device soldered to printed circuit board for SO package.

⁴Absolute maximum ratings apply to both DICE and packaged parts, unless otherwise noted.

ORDERING GUIDE

$T_A = 25^\circ\text{C}$ $V_{OS\ MAX}$ (μV)	CerDIP 8-Lead	Plastic 8-Lead	Operating Temperature Range
25	OP37AZ*		MIL
25	OP37EZ	OP37EP	IND/COM
60		OP37FP*	IND/COM
100		OP37GP	XIND
100	OP37GZ	OP37GS	XIND

*Not for new design, obsolete, April 2002.

CAUTION

ESD (electrostatic discharge) sensitive device. Electrostatic charges as high as 4000 V readily accumulate on the human body and test equipment and can discharge without detection. Although the OP37 features proprietary ESD protection circuitry, permanent damage may occur on devices subjected to high-energy electrostatic discharges. Therefore, proper ESD precautions are recommended to avoid performance degradation or loss of functionality.



SPECIFICATIONS ($V_S = \pm 15\text{ V}$, $T_A = 25^\circ\text{C}$, unless otherwise noted.)

Parameter	Symbol	Conditions	OP37A/E			OP37F			OP37G			Unit
			Min	Typ	Max	Min	Typ	Max	Min	Typ	Max	
Input Offset Voltage	V_{OS}	Note 1	10	25		20	60		30	100	μV	
Long-Term Stability	V_{OS}/Time	Notes 2, 3	0.2	1.0		0.3	1.5		0.4	2.0	$\mu\text{V}/\text{Mo}$	
Input Offset Current	I_{OS}		7	35		9	50		12	75	nA	
Input Bias Current	I_B		± 10	± 40		± 12	± 55		± 15	± 80	nA	
Input Noise Voltage	e_{np-p}	1 Hz to 10 Hz ^{3, 5}	0.08	0.18		0.08	0.18		0.09	0.25	$\mu\text{V p-p}$	
Input Noise Voltage Density	e_n	$f_0 = 10\text{ Hz}^3$ $f_0 = 30\text{ Hz}^3$ $f_0 = 1000\text{ Hz}^3$	3.5 3.1 3.0	5.5 4.5 3.8		3.5 3.1 3.0	5.5 4.5 3.8		3.8 3.3 3.2	8.0 5.6 4.5	$\text{nV}/\sqrt{\text{Hz}}$	
Input Noise Current Density	i_N	$f_0 = 10\text{ Hz}^3, 6$ $f_0 = 30\text{ Hz}^3, 6$ $f_0 = 1000\text{ Hz}^3, 6$	1.7 1.0 0.4	4.0 2.3 0.6		1.7 1.0 0.4	4.0 2.3 0.6		1.7 1.0 0.4	0.6	$\text{pA}/\sqrt{\text{Hz}}$	
Input Resistance Differential Mode	R_{IN}	Note 7	1.3	6		0.9	4.5		0.7	4	M Ω	
Input Resistance Common Mode	R_{INCM}		3			2.5			2		G Ω	
Input Voltage Range	IVR		± 11	± 12.3		± 11	± 12.3		± 11	± 12.3	V	
Common Mode Rejection Ratio	CMRR	$V_{CM} = \pm 11\text{ V}$	114	126		106	123		100	120	dB	
Power Supply Rejection Ratio	PSSR	$V_S = \pm 4\text{ V}$ to $\pm 18\text{ V}$	1	10		1	10		2	20	$\mu\text{V}/\text{V}$	
Large Signal Voltage Gain	A_{VO}	$R_L \geq 2\text{ k}\Omega$, $V_O = \pm 10\text{ V}$ $R_L \geq 1\text{ k}\Omega$, $V_O = \pm 10\text{ V}$ $R_L \geq 600\ \Omega$, $V_O = \pm 1\text{ V}$, $V_S \pm 4^4$	1000 800 250	1800 1500 700		1000 800 250	1800 1500 700		700 400 200	1500 1500 500	V/mV V/mV V/mV	
Output Voltage Swing	V_O	$R_L \geq 2\text{ k}\Omega$ $R_L \geq 600\ \Omega$ $R_L \geq 2\text{ k}\ \Omega^4$	± 12.0 ± 10 11	± 13.8 ± 11.5 17		± 12.0 ± 10 11	± 13.8 ± 11.5 17		± 11.5 ± 10 11	± 13.5 ± 11.5 17	V V V/ μs	
Slew Rate	SR		11	17		11	17		11	17	V/ μs	
Gain Bandwidth Product	GBW	$f_0 = 10\text{ kHz}^4$ $f_0 = 1\text{ MHz}$	45 40	63 40		45 40	63 40		45 40	63 40	MHz MHz	
Open-Loop Output Resistance	R_O	$V_O = 0, I_O = 0$	70			70			70		Ω	
Power Consumption	P_d	$V_O = 0$	90	140		90	140		100	170	mW	
Offset Adjustment Range		$R_p = 10\text{ k}\Omega$	± 4			± 4			± 4		mV	

NOTES

- ¹Input offset voltage measurements are performed by automated test equipment approximately 0.5 seconds after application of power. A/E grades guaranteed fully warmed up.
- ²Long term input offset voltage stability refers to the average trend line of V_{OS} vs. Time over extended periods after the first 30 days of operation. Excluding the initial hour of operation, changes in V_{OS} during the first 30 days are typically 2.5 μV —refer to typical performance curve.
- ³Sample tested.
- ⁴Guaranteed by design.
- ⁵See test circuit and frequency response curve for 0.1 Hz to 10 Hz tester.
- ⁶See test circuit for current noise measurement.
- ⁷Guaranteed by input bias current.

OP37—SPECIFICATIONS

Electrical Characteristics ($V_S = \pm 15\text{ V}$, $-55^\circ\text{C} \leq T_A \leq +125^\circ\text{C}$, unless otherwise noted.)

Parameter	Symbol	Conditions	OP37A			OP37C			Unit
			Min	Typ	Max	Min	Typ	Max	
Input Offset Voltage	V_{OS}	Note 1		10	25		30	100	μV
Average Input Offset Drift	TCV_{OS} TCV_{OSN}	Note 2 Note 3		0.2	0.6		0.4	1.8	$\mu\text{V}/^\circ\text{C}$
Input Offset Current	I_{OS}			15	50		30	135	nA
Input Bias Current	I_B			± 20	± 60		± 35	± 150	nA
Input Voltage Range	IVR		± 10.3	± 11.5		± 10.2	± 11.5		V
Common Mode Rejection Ratio	CMRR	$V_{CM} = \pm 10\text{ V}$	108	122		94	116		dB
Power Supply Rejection Ratio	PSRR	$V_S = \pm 4.5\text{ V}$ to $\pm 18\text{ V}$		2	16		4	51	$\mu\text{V}/\text{V}$
Large-Signal Voltage Gain	A_{VO}	$R_L \geq 2\text{ k}\Omega$, $V_O = \pm 10\text{ V}$	600	1200		300	800		V/mV
Output Voltage Swing	V_O	$R_L \geq 2\text{ k}\Omega$	± 11.5	± 13.5		± 10.5	± 13.0		V

Electrical Characteristics ($V_S = \pm 15\text{ V}$, $-25^\circ\text{C} \leq T_A \leq +85^\circ\text{C}$ for OP37EZ/FZ, $0^\circ\text{C} \leq T_A \leq 70^\circ\text{C}$ for OP37EP/FP, and $-40^\circ\text{C} \leq T_A \leq +85^\circ\text{C}$ for OP37GP/GS/GZ, unless otherwise noted.)

Parameter	Symbol	Conditions	OP37E			OP37F			OP37C			Unit
			Min	Typ	Max	Min	Typ	Max	Min	Typ	Max	
Input Offset Voltage	V_{OS}			20	50		40	140		55	220	μV
Average Input Offset Drift	TCV_{OS} TCV_{OSN}	Note 2 Note 3		0.2	0.6		0.3	1.3		0.4	1.8	$\mu\text{V}/^\circ\text{C}$
Input Offset Current	I_{OS}			10	50		14	85		20	135	nA
Input Bias Current	I_B			± 14	± 60		± 18	± 95		± 25	± 150	nA
Input Voltage Range	IVR		± 10.5	± 11.8		± 10.5	± 11.8		± 10.5	± 11.8		V
Common Mode Rejection Ratio	CMRR	$V_{CM} = \pm 10\text{ V}$	108	122		100	119		94	116		dB
Power Supply Rejection Ratio	PSRR	$V_S = \pm 4.5\text{ V}$ to $\pm 18\text{ V}$		2	15		2	16		4	32	$\mu\text{V}/\text{V}$
Large-Signal Voltage Gain	A_{VO}	$R_L \geq 2\text{ k}\Omega$, $V_O = \pm 10\text{ V}$	750	1500		700	1300		450	1000		V/mV
Output Voltage Swing	V_O	$R_L \geq 2\text{ k}\Omega$	± 11.7	± 13.6		± 11.4	± 13.5		± 11	± 13.3		V

NOTES

¹Input offset voltage measurements are performed by automated test equipment approximately 0.5 seconds after application of power. A/E grades guaranteed fully warmed up.

²The TC_{VOS} performance is within the specifications unnullled or when nullled with $R_p = 8\text{ k}\Omega$ to $20\text{ k}\Omega$. TC_{VOS} is 100% tested for A/E grades, sample tested for F/G grades.

³Guaranteed by design.

BINDING DIAGRAM

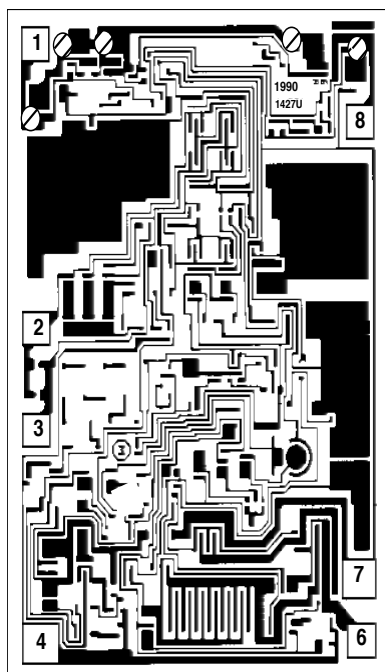

- 1. NULL
- 2. (-) INPUT
- 3. (+) INPUT
- 4. V-
- 6. OUTPUT
- 7. V+
- 8. NULL

Wafer Test Limits ($V_S = \pm 15\text{ V}$, $T_A = 25^\circ\text{C}$ for OP37N, OP37G, and OP37GR devices; $T_A = 125^\circ\text{C}$ for OP37NT and OP37GT devices, unless otherwise noted.)

Parameter	Symbol	Conditions	OP37NT Limit	OP37N Limit	OP37GT Limit	OP37G Limit	OP37GR Limit	Unit
Input Offset Voltage	V_{OS}	Note 1	60	35	200	60	100	$\mu\text{V MAX}$
Input Offset Current	I_{OS}		50	35	85	50	75	nA MAX
Input Bias Current	I_B		± 60	± 40	± 95	± 55	± 80	nA MAX
Input Voltage Range	IVR		± 10.3	± 11	± 10.3	± 11	± 11	V MIN
Common Mode Rejection Ratio	CMRR	$V_{CM} = \pm 11\text{ V}$	108	114	100	106	100	dB MIN
Power Supply Rejection Ratio	PSRR	$T_A = 25^\circ\text{C}$, $V_S = \pm 4\text{ V to } \pm 18\text{ V}$ $T_A = 125^\circ\text{C}$, $V_S = \pm 4.5\text{ V to } \pm 18\text{ V}$	10	10	10	10	20	$\mu\text{V/V MAX}$
Large-Signal Voltage Gain	A_{VO}	$R_L \geq 2\text{ k}\Omega$, $V_O = \pm 10\text{ V}$ $R_L \geq 1\text{ k}\Omega$, $V_O = \pm 10\text{ V}$	600	1000	500	1000	700	V/mV MIN
Output Voltage Swing	V_O	$R_L \geq 2\text{ k}\Omega$ $R_L \geq 600\text{ k}\Omega$	± 11.5	± 12 ± 10	± 11	± 12 ± 10	± 11.5 ± 10	V MIN V MIN
Power Consumption	P_d	$V_O = 0$		140		140	170	mW MAX

NOTES

For 25°C characteristics of OP37NT and OP37GT devices, see OP37N and OP37G characteristics, respectively.

Electrical tests are performed at wafer probe to the limits shown. Due to variations in assembly methods and normal yield loss, yield after packaging is not guaranteed for standard product dice. Consult factory to negotiate specifications based on dice lot qualification through sample lot assembly and testing.

OP37

Typical Electrical Characteristics ($V_S = \pm 15\text{ V}$, $T_A = 25^\circ\text{C}$, unless otherwise noted.)

Parameter	Symbol	Conditions	OP37NT Typical	OP37N Typical	OP37GT Typical	OP37G Typical	OP37GR Typical	Unit
Average Input Offset Voltage Drift	TCV_{OS} or TCV_{OSN}	Nulled or Unnulled $R_P = 8\text{ k}\Omega$ to $20\text{ k}\Omega$	0.2	0.2	0.3	0.3	0.4	$\mu\text{V}/^\circ\text{C}$
Average Input Offset Current Drift	TCI_{OS}		80	80	130	130	180	$\text{pA}/^\circ\text{C}$
Average Input Bias Current Drift	TCI_B		100	100	160	160	200	$\text{pA}/^\circ\text{C}$
Input Noise Voltage Density	e_n	$f_0 = 10\text{ Hz}$	3.5	3.5	3.5	3.5	3.8	$\text{nV}/\sqrt{\text{Hz}}$
		$f_0 = 30\text{ Hz}$	3.1	3.1	3.1	3.1	3.3	$\text{nV}/\sqrt{\text{Hz}}$
		$f_0 = 1000\text{ Hz}$	3.0	3.0	3.0	3.0	3.2	$\text{nV}/\sqrt{\text{Hz}}$
Input Noise Current Density	i_n	$f_0 = 10\text{ Hz}$	1.7	1.7	1.7	1.7	1.7	$\text{pA}/\sqrt{\text{Hz}}$
		$f_0 = 30\text{ Hz}$	1.0	1.0	1.0	1.0	1.0	$\text{pA}/\sqrt{\text{Hz}}$
		$f_0 = 1000\text{ Hz}$	0.4	0.4	0.4	0.4	0.4	$\text{pA}/\sqrt{\text{Hz}}$
Input Noise Voltage	$e_{n\text{ p-p}}$	0.1 Hz to 10 Hz	0.08	0.08	0.08	0.08	0.09	$\mu\text{V p-p}$
Slew Rate	SR	$R_L \geq 2\text{ k}\Omega$	17	17	17	17	17	$\text{V}/\mu\text{s}$
Gain Bandwidth Product	GBW	$f_0 = 10\text{ kHz}$	63	63	63	63	63	MHz

Typical Performance Characteristics—OP37

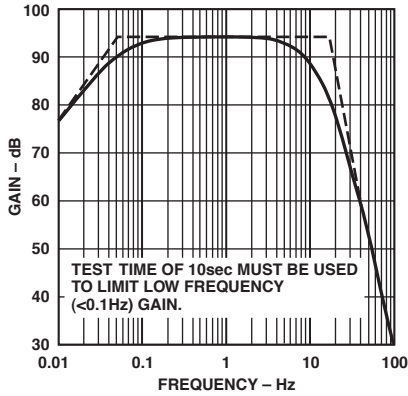

TPC 1. Noise-Tester Frequency Response (0.1 Hz to 10 Hz)

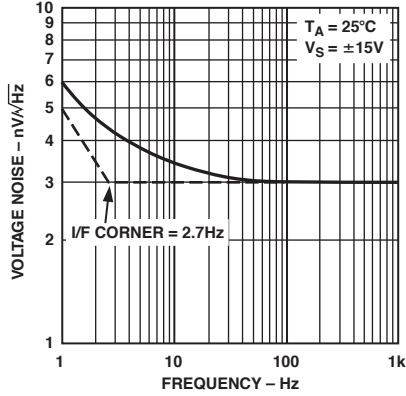

TPC 2. Voltage Noise Density vs. Frequency

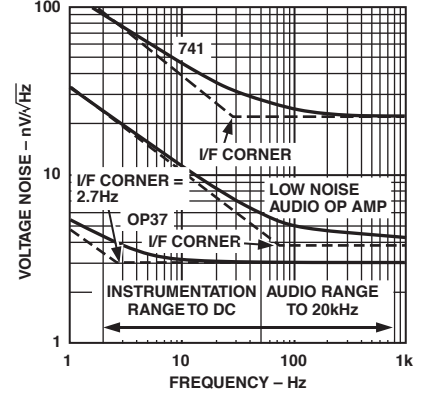

TPC 3. A Comparison of Op Amp Voltage Noise Spectra

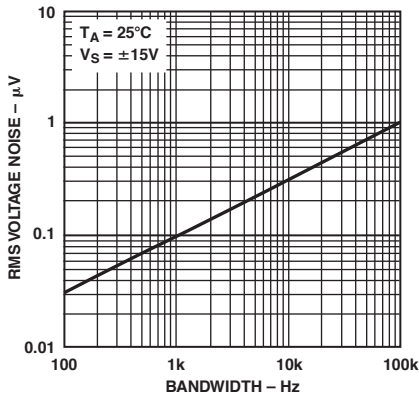

TPC 4. Input Wideband Voltage Noise vs. Bandwidth (0.1 Hz to Frequency Indicated)

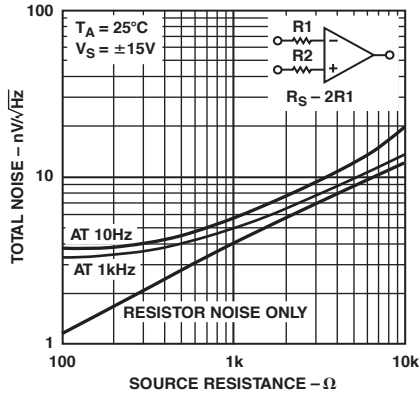

TPC 5. Total Noise vs. Source Resistance

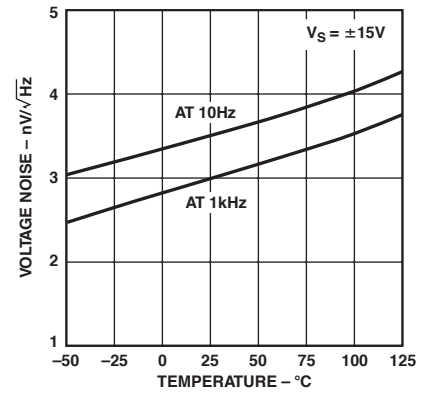

TPC 6. Voltage Noise Density vs. Temperature

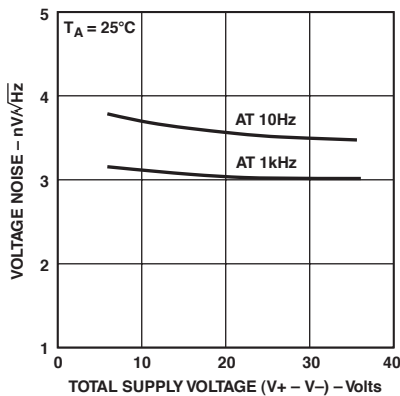

TPC 7. Voltage Noise Density vs. Supply Voltage

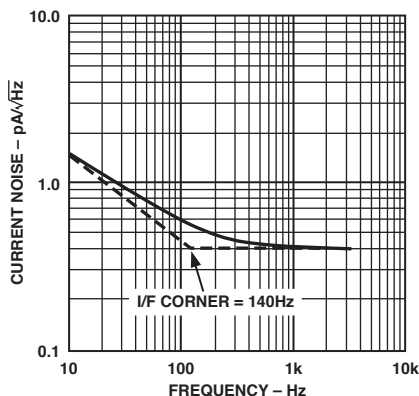

TPC 8. Current Noise Density vs. Frequency

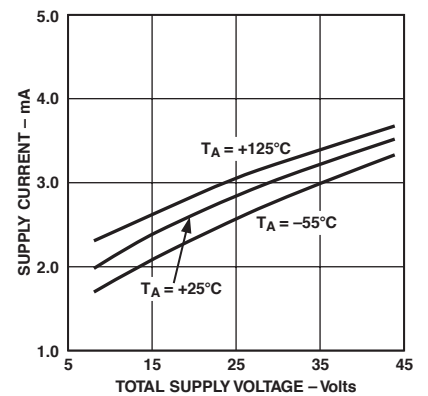

TPC 9. Supply Current vs. Supply Voltage

OP37

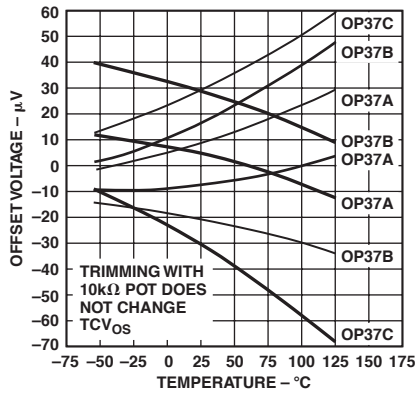

TPC 10. Offset Voltage Drift of Eight Representative Units vs. Temperature

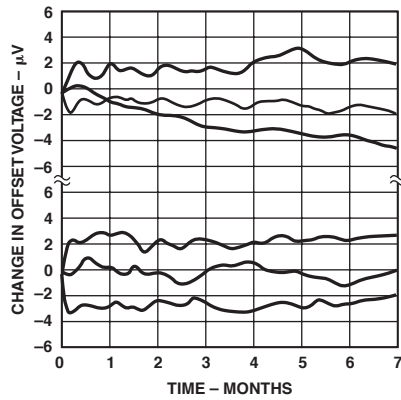

TPC 11. Long-Term Offset Voltage Drift of Six Representative Units

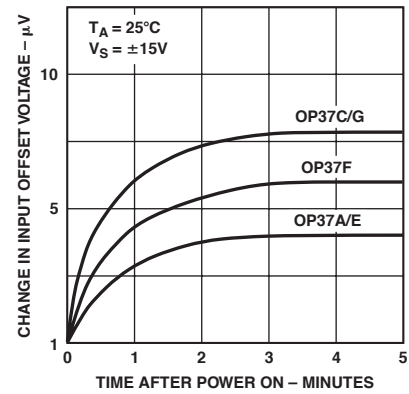

TPC 12. Warm Up Offset Voltage Drift

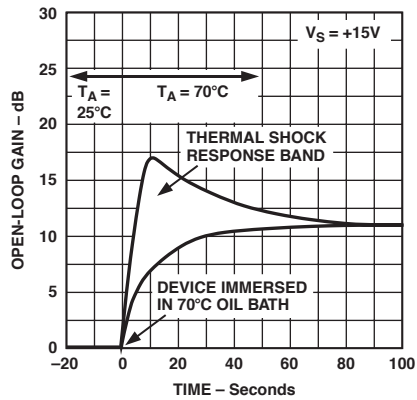

TPC 13. Offset Voltage Change Due to Thermal Shock

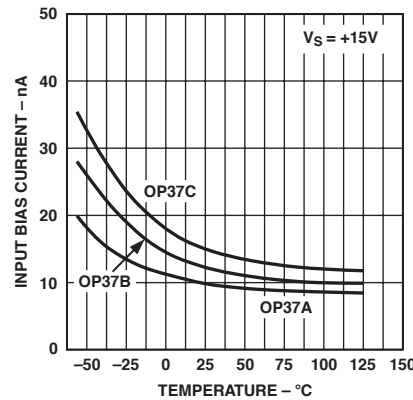

TPC 14. Input Bias Current vs. Temperature

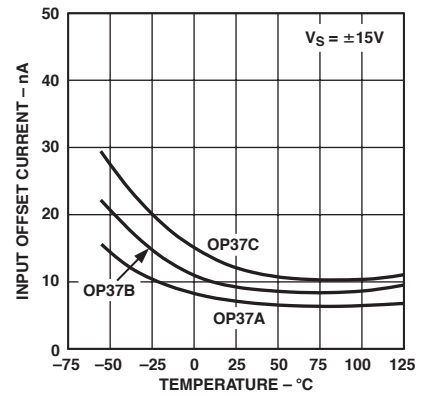

TPC 15. Input Offset Current vs. Temperature

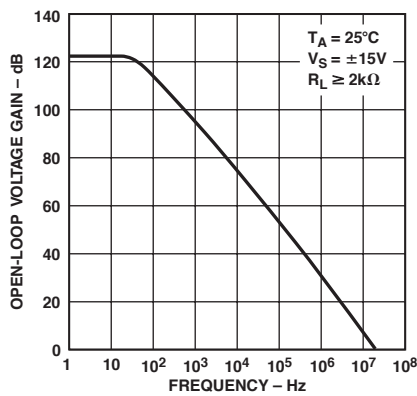

TPC 16. Open-Loop Gain vs. Frequency

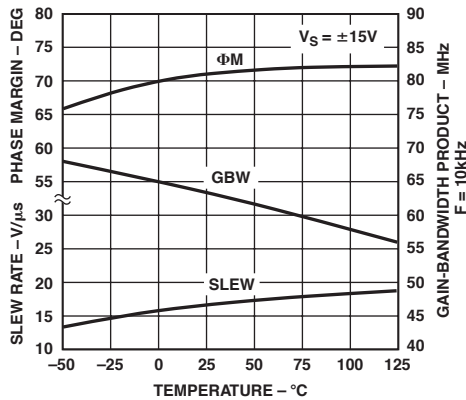

TPC 17. Slew Rate, Gain Bandwidth Product, Phase Margin vs. Temperature

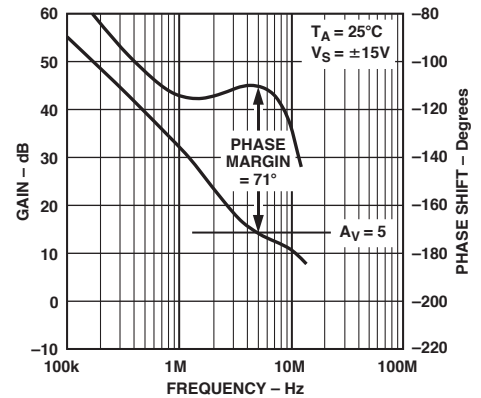

TPC 18. Gain, Phase Shift vs. Frequency

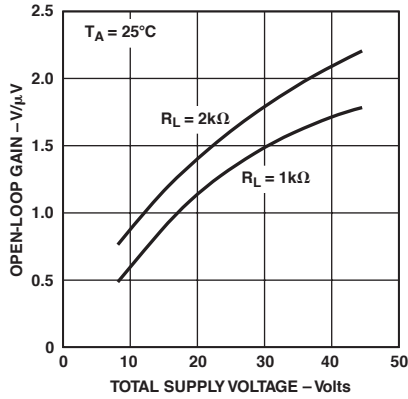

TPC 19. Open-Loop Voltage Gain vs. Supply Voltage

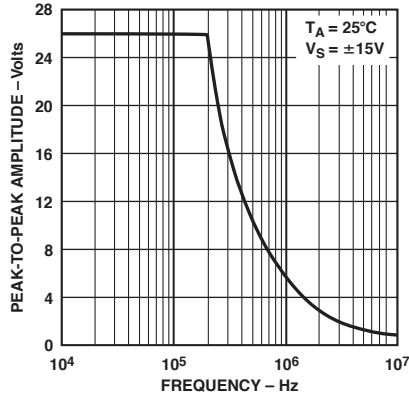

TPC 20. Maximum Output Swing vs. Frequency

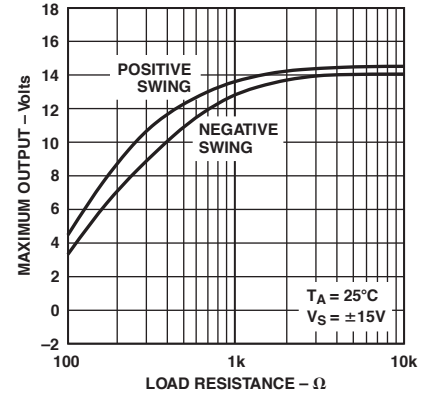

TPC 21. Maximum Output Voltage vs. Load Resistance

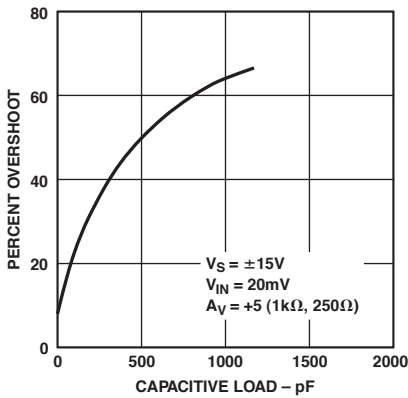

TPC 22. Small-Signal Overshoot vs. Capacitive Load

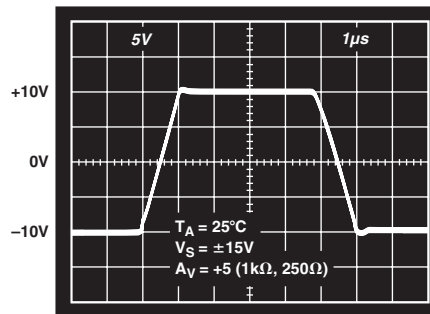

TPC 23. Large-Signal Transient Response

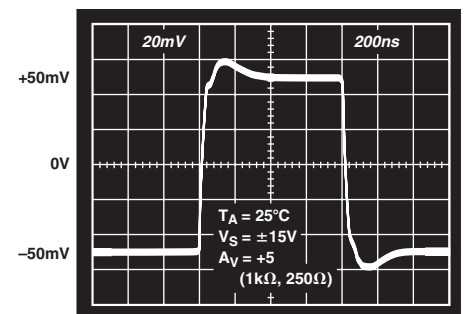

TPC 24. Small-Signal Transient Response

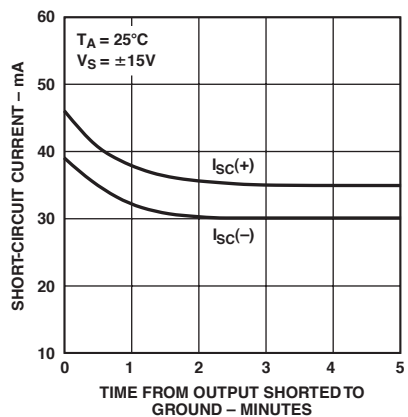

TPC 25. Short-Circuit Current vs. Time

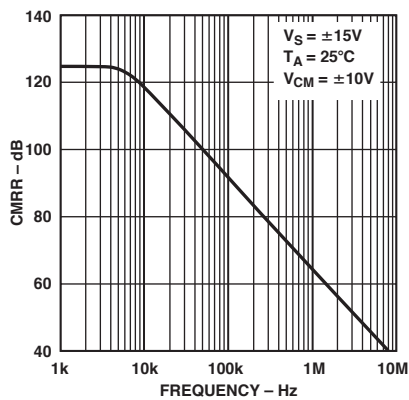

TPC 26. CMRR vs. Frequency

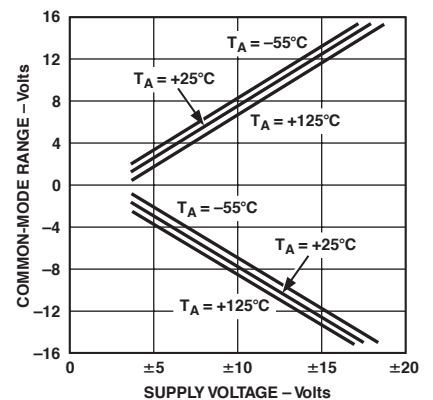

TPC 27. Common-Mode Input Range vs. Supply Voltage

OP37

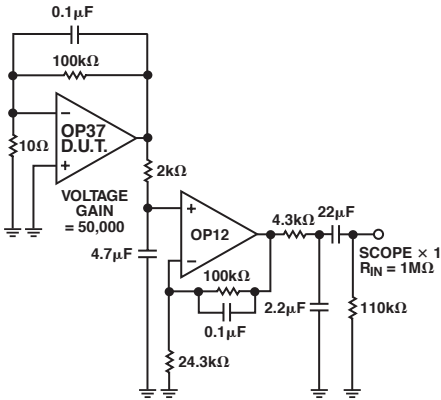

TPC 28. Noise Test Circuit (0.1 Hz to 10 Hz)

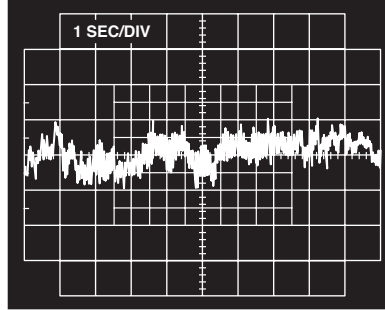

TPC 29. Low-Frequency Noise

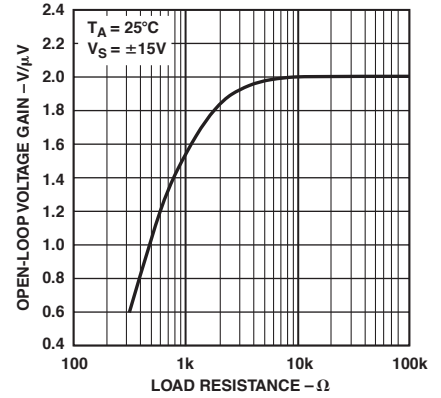

TPC 30. Open-Loop Voltage Gain vs. Load Resistance

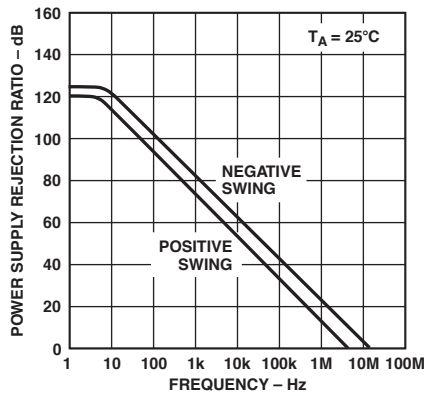

TPC 31. PSRR vs. Frequency

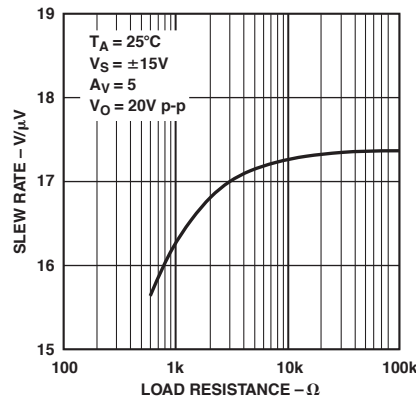

TPC 32. Slew Rate vs. Load

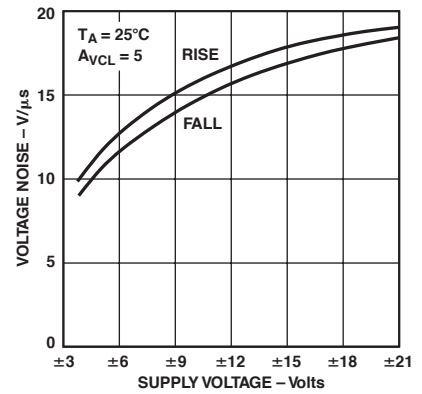

TPC 33. Slew Rate vs. Supply Voltage

APPLICATIONS INFORMATION

OP37 Series units may be inserted directly into 725 and OP07 sockets with or without removal of external compensation or nulling components. Additionally, the OP37 may be fitted to unnullled 741 type sockets; however, if conventional 741 nulling circuitry is in use, it should be modified or removed to ensure correct OP37 operation. OP37 offset voltage may be nulled to zero (or other desired setting) using a potentiometer (see figure 1).

The OP37 provides stable operation with load capacitances of up to 1000 pF and ± 10 V swings; larger capacitances should be decoupled with a 50 Ω resistor inside the feedback loop. Closed loop gain must be at least five. For closed loop gain between five to ten, the designer should consider both the OP27 and the OP37. For gains above ten, the OP37 has a clear advantage over the unity stable OP27.

Thermoelectric voltages generated by dissimilar metals at the input terminal contacts can degrade the drift performance. Best operation will be obtained when both input contacts are maintained at the same temperature.

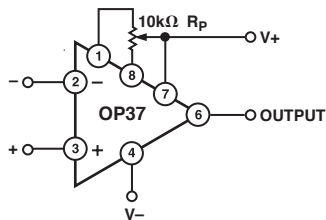

Figure 1. Offset Nulling Circuit

Offset Voltage Adjustment

The input offset voltage of the OP37 is trimmed at wafer level. However, if further adjustment of V_{OS} is necessary, a 10 k Ω trim potentiometer may be used. TCV_{OS} is not degraded (see offset nulling circuit). Other potentiometer values from 1 k Ω to 1 M Ω can be used with a slight degradation (0.1 $\mu\text{V}/^\circ\text{C}$ to 0.2 $\mu\text{V}/^\circ\text{C}$) of TCV_{OS} . Trimming to a value other than zero creates a drift of approximately $(V_{OS}/300)$ $\mu\text{V}/^\circ\text{C}$. For example, the change in TCV_{OS} will be 0.33 $\mu\text{V}/^\circ\text{C}$ if V_{OS} is adjusted to 100 μV . The offset voltage adjustment range with a 10 k Ω potentiometer is ± 4 mV. If smaller adjustment range is required, the nulling sensitivity can be reduced by using a smaller pot in conjunction with fixed resistors. For example, the network shown in figure 2 will have a ± 280 μV adjustment range.

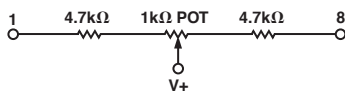

Figure 2. Offset Voltage Adjustment

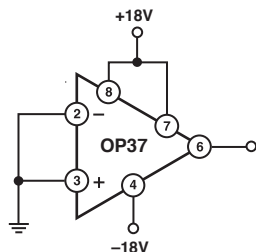

Figure 3. Burn-In Circuit

Noise Measurements

To measure the 80 nV peak-to-peak noise specification of the OP37 in the 0.1 Hz to 10 Hz range, the following precautions must be observed:

- The device has to be warmed-up for at least five minutes. As shown in the warm-up drift curve, the offset voltage typically changes 4 μV due to increasing chip temperature after power up. In the ten second measurement interval, these temperature-induced effects can exceed tens of nanovolts.
- For similar reasons, the device has to be well-shielded from air currents. Shielding minimizes thermocouple effects.
- Sudden motion in the vicinity of the device can also “feedthrough” to increase the observed noise.
- The test time to measure 0.1 Hz to 10 Hz noise should not exceed 10 seconds. As shown in the noise-tester frequency response curve, the 0.1 Hz corner is defined by only one zero. The test time of ten seconds acts as an additional zero to eliminate noise contributions from the frequency band below 0.1 Hz.
- A noise-voltage-density test is recommended when measuring noise on a large number of units. A 10 Hz noise-voltage-density measurement will correlate well with a 0.1 Hz-to-10 Hz peak-to-peak noise reading, since both results are determined by the white noise and the location of the 1/f corner frequency.

Optimizing Linearity

Best linearity will be obtained by designing for the minimum output current required for the application. High gain and excellent linearity can be achieved by operating the op amp with a peak output current of less than ± 10 mA.

Instrumentation Amplifier

A three-op-amp instrumentation amplifier, shown in figure 4, provides high gain and wide bandwidth. The input noise of the circuit below is 4.9 $\text{nV}/\sqrt{\text{Hz}}$. The gain of the input stage is set at 25 and the gain of the second stage is 40; overall gain is 1000. The amplifier bandwidth of 800 kHz is extraordinarily good for a precision instrumentation amplifier. Set to a gain of 1000, this yields a gain bandwidth product of 800 MHz. The full-power bandwidth for a 20 V p-p output is 250 kHz. Potentiometer R7 provides quadrature trimming to optimize the instrumentation amplifier’s ac common-mode rejection.

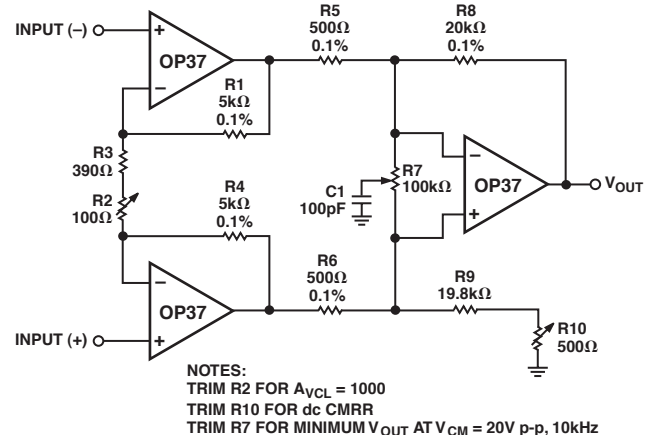

Figure 4a. Instrumentation Amplifier

OP37

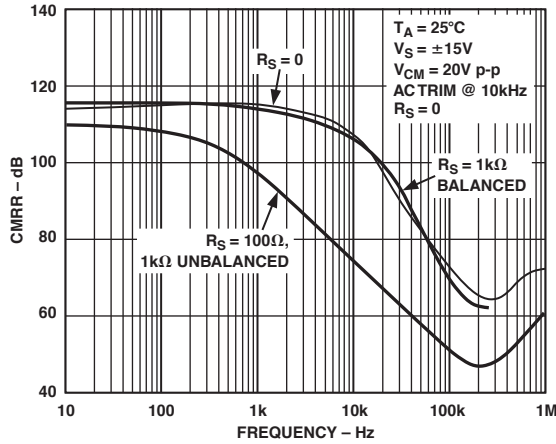

Figure 4b. CMRR vs. Frequency

Comments on Noise

The OP37 is a very low-noise monolithic op amp. The outstanding input voltage noise characteristics of the OP37 are achieved mainly by operating the input stage at a high quiescent current. The input bias and offset currents, which would normally increase, are held to reasonable values by the input bias current cancellation circuit. The OP37A/E has I_B and I_{OS} of only ± 40 nA and 35 nA respectively at 25°C. This is particularly important when the input has a high source resistance. In addition, many audio amplifier designers prefer to use direct coupling. The high I_B , TCV_{OS} of previous designs have made direct coupling difficult, if not impossible, to use.

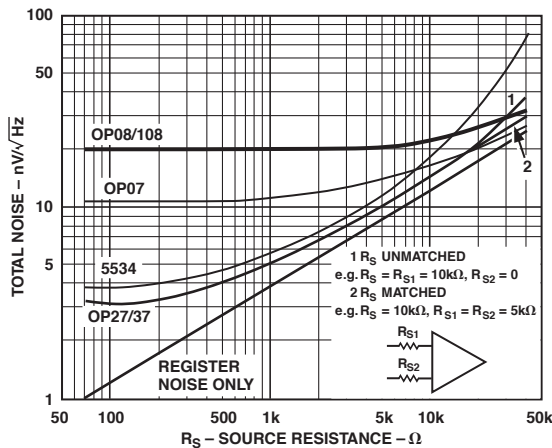

Figure 5. Noise vs. Resistance (Including Resistor Noise @ 1000 Hz)

Voltage noise is inversely proportional to the square-root of bias current, but current noise is proportional to the square-root of bias current. The OP37's noise advantage disappears when high source-resistors are used. Figures 5, 6, and 7 compare OP-37 observed total noise with the noise performance of other devices in different circuit applications.

$$\text{Total noise} = [(\text{Voltage noise})^2 + (\text{current noise} \times RS)^2 + (\text{resistor noise})^2]^{1/2}$$

Figure 5 shows noise versus source resistance at 1000 Hz. The same plot applies to wideband noise. To use this plot, just multiply the vertical scale by the square-root of the bandwidth.

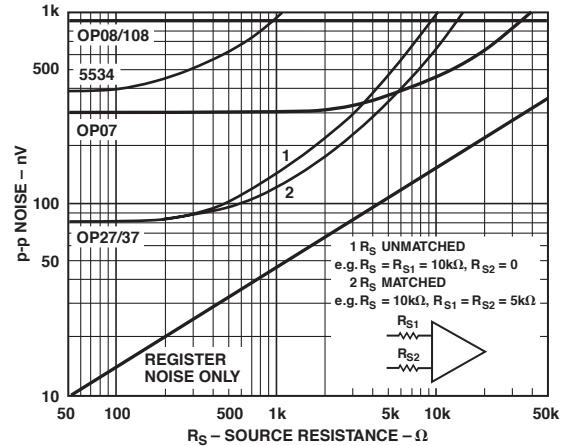

Figure 6. Peak-to-Peak Noise (0.1 Hz to 10 Hz) vs. Source Resistance (Includes Resistor Noise)

At $R_S < 1$ kΩ the OP37's low voltage noise is maintained. With $R_S < 1$ kΩ, total noise increases, but is dominated by the resistor noise rather than current or voltage noise. It is only beyond R_S of 20 kΩ that current noise starts to dominate. The argument can be made that current noise is not important for applications with low to-moderate source resistances. The crossover between the OP37 and OP07 and OP08 noise occurs in the 15 kΩ to 40 kΩ region.

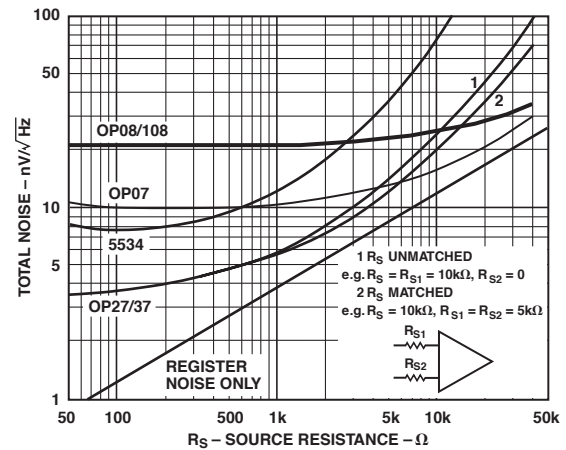

Figure 7. Noise vs. Source resistance (Includes Resistor Noise @ 10 Hz)

Figure 6 shows the 0.1 Hz to 10 Hz peak-to-peak noise. Here the picture is less favorable; resistor noise is negligible, current noise becomes important because it is inversely proportional to the square-root of frequency. The crossover with the OP07 occurs in the 3 kΩ to 5 kΩ range depending on whether balanced or unbalanced source resistors are used (at 3 kΩ the I_B , I_{OS} error also can be three times the V_{OS} spec.).

Therefore, for low-frequency applications, the OP07 is better than the OP27/37 when $R_S > 3$ kΩ. The only exception is when gain error is important. Figure 7 illustrates the 10 Hz noise. As expected, the results are between the previous two figures.

For reference, typical source resistances of some signal sources are listed in Table I.

Table I.

Device	Source Impedance	Comments
Strain Gauge	<500 Ω	Typically used in low-frequency applications.
Magnetic Tapehead	<1500 Ω	Low I _B very important to reduce set-magnetization problems when direct coupling is used. OP37 I _B can be neglected.
Magnetic Phonograph Cartridges	<1500 Ω	Similar need for low I _B in direct coupled applications. OP37 will not introduce any self-magnetization problem.
Linear Variable Differential Transformer	<1500 Ω	Used in rugged servo-feedback applications. Bandwidth of interest is 400 Hz to 5 kHz.

Audio Applications

The following applications information has been abstracted from a PMI article in the 12/20/80 issue of Electronic Design magazine and updated.

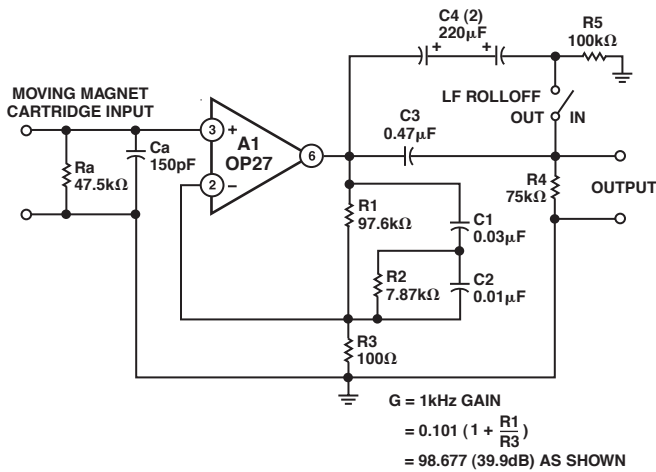

Figure 8. Phono Pre-Amplifier Circuit

Figure 8 is an example of a phono pre-amplifier circuit using the OP27 for A1; R1-R2-C1-C2 form a very accurate RIAA network with standard component values. The popular method to accomplish RIAA phono equalization is to employ frequency-dependent feedback around a high-quality gain block. Properly chosen, an RC network can provide the three necessary time constants of 3180 μs, 318 μs, and 75 μs.¹

For initial equalization accuracy and stability, precision metal-film resistors and film capacitors of polystyrene or polypropylene are recommended since they have low voltage coefficients, dissipation factors, and dielectric absorption.⁴ (High-K ceramic capacitors should be avoided here, though low-K ceramics—such as NPO types, which have excellent dissipation factors, and somewhat lower dielectric absorption—can be considered for small values or where space is at a premium.)

The OP37 brings a 3.2 nV/√Hz voltage noise and 0.45 pA/√Hz current noise to this circuit. To minimize noise from other sources, R3 is set to a value of 100 Ω, which generates a voltage noise of 1.3 nV/√Hz. The noise increases the 3.2 nV/√Hz of the amplifier

by only 0.7 dB. With a 1 kΩ source, the circuit noise measures 63 dB below a 1 mV reference level, unweighted, in a 20 kHz noise bandwidth.

Gain (G) of the circuit at 1 kHz can be calculated by the expression:

$$G = 0.101 \left(1 + \frac{R_1}{R_3} \right)$$

For the values shown, the gain is just under 100 (or 40 dB). Lower gains can be accommodated by increasing R3, but gains higher than 40 dB will show more equalization errors because of the 8 MHz gain bandwidth of the OP27.

This circuit is capable of very low distortion over its entire range, generally below 0.01% at levels up to 7 V rms. At 3 V output levels, it will produce less than 0.03% total harmonic distortion at frequencies up to 20 kHz.

Capacitor C3 and resistor R4 form a simple -6 dB per octave rumble filter, with a corner at 22 Hz. As an option, the switch selected shunt capacitor C4, a nonpolarized electrolytic, bypasses the low-frequency rolloff. Placing the rumble filter's high-pass action after the preamp has the desirable result of discriminating against the RIAA amplified low frequency noise components and pickup-produced low-frequency disturbances.

A preamplifier for NAB tape playback is similar to an RIAA phono preamp, though more gain is typically demanded, along with equalization requiring a heavy low-frequency boost. The circuit in Figure 8 can be readily modified for tape use, as shown by Figure 9.

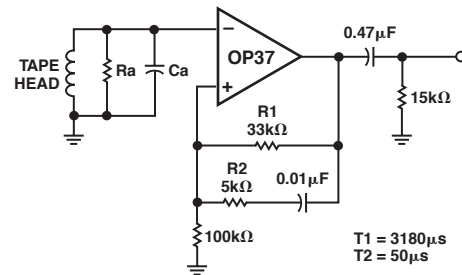

Figure 9. Tape-Head Preamplifier

While the tape-equalization requirement has a flat high frequency gain above 3 kHz (t₂ = 50 μs), the amplifier need not be stabilized for unity gain. The uncompensated OP37 provides a greater bandwidth and slew rate. For many applications, the idealized time constants shown may require trimming of Ra and R2 to optimize frequency response for non ideal tape head performance and other factors.⁵

The network values of the configuration yield a 50 dB gain at 1 kHz, and the dc gain is greater than 70 dB. Thus, the worst-case output offset is just over 500 mV. A single 0.47 μF output capacitor can block this level without affecting the dynamic range.

The tape head can be coupled directly to the amplifier input, since the worst-case bias current of 85 nA with a 400 mH, 100 μin. head (such as the PRB2H7K) will not be troublesome.

One potential tape-head problem is presented by amplifier bias-current transients which can magnetize a head. The OP27 and

OP37

OP37 are free of bias-current transients upon power up or power down. However, it is always advantageous to control the speed of power supply rise and fall, to eliminate transients.

In addition, the dc resistance of the head should be carefully controlled, and preferably below 1 k Ω . For this configuration, the bias-current induced offset voltage can be greater than the 170 pV maximum offset if the head resistance is not sufficiently controlled.

A simple, but effective, fixed-gain transformerless microphone preamp (Figure 10) amplifies differential signals from low impedance microphones by 50 dB, and has an input impedance of 2 k Ω . Because of the high working gain of the circuit, an OP37 helps to preserve bandwidth, which will be 110 kHz. As the OP37 is a decompensated device (minimum stable gain of 5), a dummy resistor, R_p, may be necessary, if the microphone is to be unplugged. Otherwise the 100% feedback from the open input may cause the amplifier to oscillate.

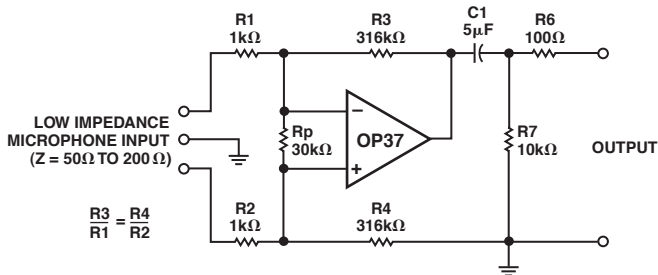

Figure 10. Fixed Gain Transformerless Microphone Preamp

Common-mode input-noise rejection will depend upon the match of the bridge-resistor ratios. Either close-tolerance (0.1%) types should be used, or R4 should be trimmed for best CMRR. All resistors should be metal-film types for best stability and low noise.

Noise performance of this circuit is limited more by the input resistors R1 and R2 than by the op amp, as R1 and R2 each generate a 4 nV/ $\sqrt{\text{Hz}}$ noise, while the op amp generates a 3.2 nV/ $\sqrt{\text{Hz}}$ noise. The rms sum of these predominant noise sources will be about 6 nV/ $\sqrt{\text{Hz}}$, equivalent to 0.9 μV in a 20 kHz noise bandwidth, or nearly 61 dB below a 1 mV input signal. Measurements confirm this predicted performance.

For applications demanding appreciably lower noise, a high quality microphone-transformer-coupled preamp (Figure 11) incorporates the internally compensated. T1 is a JE-115K-E 150 Ω /15 k Ω transformer which provides an optimum source resistance for the OP27 device. The circuit has an overall gain of 40 dB, the product of the transformer's voltage setup and the op amp's voltage gain.

Gain may be trimmed to other levels, if desired, by adjusting R2 or R1. Because of the low offset voltage of the OP27, the output offset of this circuit will be very low, 1.7 mV or less, for a 40 dB gain. The typical output blocking capacitor can be eliminated in such cases, but is desirable for higher gains to eliminate switching transients.

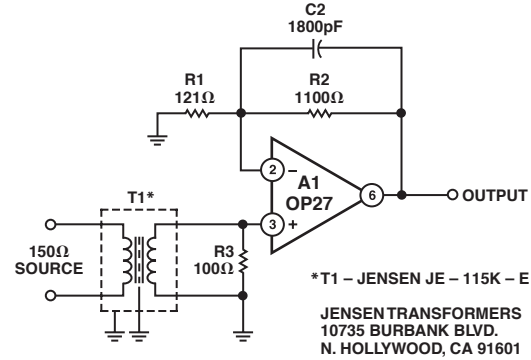

Figure 11. Microphone Transformer Coupled Preamp

Capacitor C2 and resistor R2 form a 2 μs time constant in this circuit, as recommended for optimum transient response by the transformer manufacturer. With C2 in use, A1 must have unity-gain stability. For situations where the 2 μs time constant is not necessary, C2 can be deleted, allowing the faster OP37 to be employed.

Some comment on noise is appropriate to understand the capability of this circuit. A 150 Ω resistor and R1 and R2 gain resistors connected to a noiseless amplifier will generate 220 nV of noise in a 20 kHz bandwidth, or 73 dB below a 1 mV reference level. Any practical amplifier can only approach this noise level; it can never exceed it. With the OP27 and T1 specified, the additional noise degradation will be close to 3.6 dB (or -69.5 referenced to 1 mV).

References

1. Lipshitz, S.P., "On RIAA Equalization Networks," JAES, Vol. 27, June 1979, p. 458-4S1.
2. Jung, W.G., *IC Op Amp Cookbook*, 2nd Ed., H.W. Sams and Company, 1980.
3. Jung, W.G., *Audio /C Op Amp Applications*, 2nd Ed., H.W. Sams and Company, 1978.
4. Jung, W.G., and Marsh, R.M., "Picking Capacitors." *Audio*, February & March, 1980.
5. Ojala, M., "Feedback-Generated Phase Nonlinearity in Audio Amplifiers," London AES Convention, March 1980, preprint 197B.
6. Stout, D.F., and Kaufman, M., *Handbook of Operational Amplifier Circuit Design*, New York, McGraw Hill, 1976.

OUTLINE DIMENSIONS

8-Lead Ceramic DIP – Glass Hermetic Seal [CERDIP]

(Q-8)

Dimensions shown in inches and (millimeters)

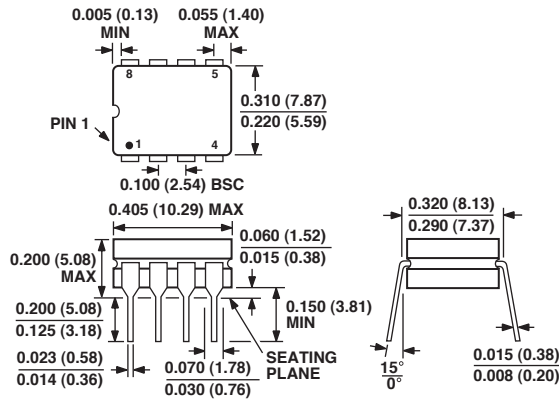

CONTROLLING DIMENSIONS ARE IN INCHES; MILLIMETERS DIMENSIONS (IN PARENTHESES) ARE ROUNDED-OFF INCH EQUIVALENTS FOR REFERENCE ONLY AND ARE NOT APPROPRIATE FOR USE IN DESIGN

8-Lead Plastic Dual-in-Line Package [PDIP]

(N-8)

Dimensions shown in inches and (millimeters)

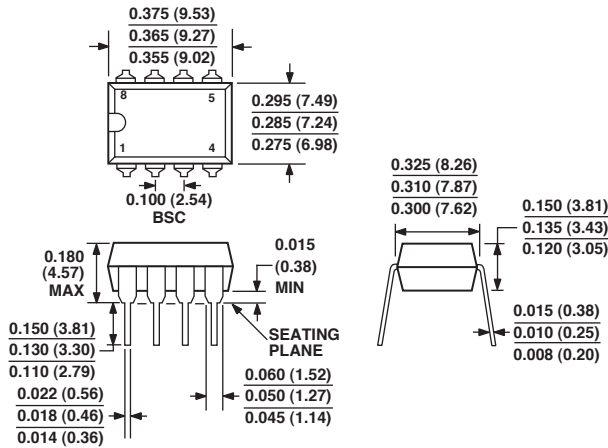

COMPLIANT TO JEDEC STANDARDS MO-095AA

CONTROLLING DIMENSIONS ARE IN INCHES; MILLIMETER DIMENSIONS (IN PARENTHESES) ARE ROUNDED-OFF INCH EQUIVALENTS FOR REFERENCE ONLY AND ARE NOT APPROPRIATE FOR USE IN DESIGN

8-Lead Standard Small Outline Package [SOIC]

Narrow Body

(RN-8)

Dimensions shown in millimeters and (inches)

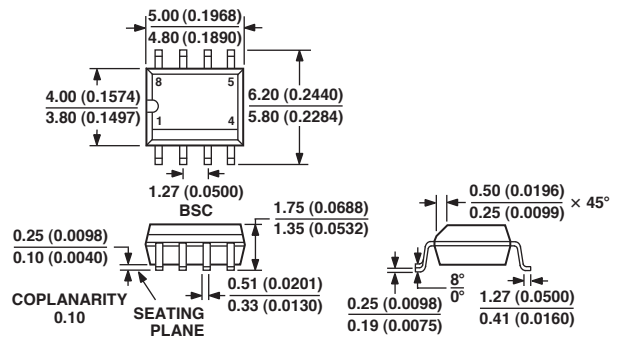

COMPLIANT TO JEDEC STANDARDS MS-012AA

CONTROLLING DIMENSIONS ARE IN MILLIMETERS; INCH DIMENSIONS (IN PARENTHESES) ARE ROUNDED-OFF MILLIMETER EQUIVALENTS FOR REFERENCE ONLY AND ARE NOT APPROPRIATE FOR USE IN DESIGN

OP37

Revision History

Location	Page
12/02–Data Sheet changed from REV. A to REV. B.	
Edits to BINDING DIAGRAM	5
Edits to Caption for TPC 31	10
Edits to APPLICATIONS INFORMATION Section	11
Added Caption to Figure 2	11
Added Caption to Figures 4a and 4b	11
Added Caption to Figures 8–11	13
Updated OUTLINE DIMENSIONS	15
2/02–Data Sheet changed from REV. 0 to REV. A.	
Edits to FEATURES	1
Edits to ORDERING INFORMATION	1
Edits to PIN CONNECTIONS	1
Edits to ABSOLUTE MAXIMUM RATINGS	2
Edits to PACKAGE TYPE	2
Edits to ELECTRICAL CHARACTERISTICS	3
Edits to APPLICATIONS INFORMATION	8

C00319–0–12/02(B)

PRINTED IN U.S.A.