

FEATURES

- Wide input range
- Rugged input overvoltage protection
- Low supply current: 220 μ A maximum
- Low power dissipation: 0.55 mW at $V_s = 2.5$ V
- Bandwidth: 550 kHz
- CMRR: 86 dB minimum, dc to 5 kHz
- Low offset voltage drift: ± 2 μ V/ $^{\circ}$ C maximum (AD8276B)
- Low gain drift: 1 ppm/ $^{\circ}$ C maximum (AD8276B)
- Enhanced slew rate: 1.1 V/ μ s
- Wide power supply range:
 - Single supply: 2.5 V to 36 V
 - Dual supplies: ± 2 V to ± 18 V
- 8-lead SOIC and MSOP packages

APPLICATIONS

- Voltage measurement and monitoring
- Current measurement and monitoring
- Instrumentation amplifier building block
- Differential output instrumentation amplifier
- Portable, battery-powered equipment
- Medical instrumentation
- Test and measurement

GENERAL DESCRIPTION

The AD8276 is a general-purpose unity-gain difference amplifier intended for precision signal conditioning in power critical applications that require both high performance and low power. The AD8276 provides exceptional common-mode rejection ratio (86 dB) and high bandwidth while amplifying signals well beyond the supply rails. The on-chip resistors are laser-trimmed for excellent gain accuracy and high common-mode rejection ratio. They also have outstanding gain temperature coefficient.

The amplifier's common-mode range extends to almost double the supply voltage, making it ideal for single-supply applications that require a high common-mode voltage range.

FUNCTIONAL BLOCK DIAGRAM

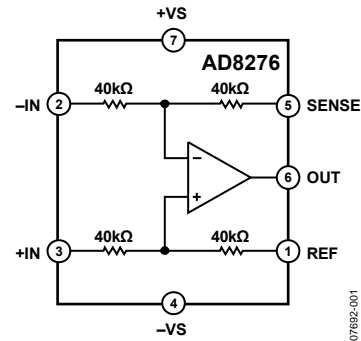

Figure 1.

07892-001

Table 1. Difference Amplifiers by Category

Low Distortion	High Voltage	Current Sensing	Low Power
AD8270	AD628	AD8202 (U) ¹	AD8276
AD8271	AD629	AD8203 (U) ¹	
AD8273		AD8205 (B) ¹	
AD8274		AD8206 (B) ¹	
AMP03		AD8216 (B) ¹	

¹ U = unidirectional, B = bidirectional.

The AD8276 is unity-gain stable. Intended as a difference amplifier, it can also be connected in a high precision, single-ended configuration with $G = -1, +1, +2,$ or $+1/2$.

The AD8276 operates on single supplies (2.5 V to 36 V) or dual supplies (± 2 V to ± 18 V). The maximum quiescent supply current is 220 μ A, which makes it ideal for battery operated and portable systems.

The AD8276 is available in the space-saving 8-lead MSOP and SOIC packages. It is specified for performance over the industrial temperature range of -40° C to $+85^{\circ}$ C and is fully RoHS compliant.

Rev. 0

Information furnished by Analog Devices is believed to be accurate and reliable. However, no responsibility is assumed by Analog Devices for its use, nor for any infringements of patents or other rights of third parties that may result from its use. Specifications subject to change without notice. No license is granted by implication or otherwise under any patent or patent rights of Analog Devices. Trademarks and registered trademarks are the property of their respective owners.

TABLE OF CONTENTS

Features	1	Theory of Operation	12
Applications.....	1	Circuit Information.....	12
Functional Block Diagram	1	Driving the AD8276.....	12
General Description	1	Power Supplies.....	12
Revision History	2	Input Voltage Range.....	12
Specifications.....	3	Applications Information	13
Absolute Maximum Ratings.....	5	Configurations.....	13
Thermal Resistance	5	Differential Output	13
Maximum Power Dissipation	5	Instrumentation Amplifier.....	14
Short-Circuit Current	5	Current Source.....	14
ESD Caution.....	5	Outline Dimensions	15
Pin Configurations and Function Descriptions	6	Ordering Guide	16
Typical Performance Characteristics	7		

REVISION HISTORY

5/09—Revision 0: Initial Version

SPECIFICATIONS

$V_S = \pm 5\text{ V}$ to $\pm 15\text{ V}$, $V_{REF} = 0\text{ V}$, $T_A = 25^\circ\text{C}$, $R_L = 10\text{ k}\Omega$ connected to ground, unless otherwise noted.

Table 2.

Parameter	Conditions	Grade B			Grade A			Unit
		Min	Typ	Max	Min	Typ	Max	
INPUT CHARACTERISTICS								
System Offset ¹			150	200		100	500	μV
vs. Temperature	$T_A = -40^\circ\text{C}$ to $+85^\circ\text{C}$			200			500	μV
Average Temperature Coefficient	$T_A = -40^\circ\text{C}$ to $+85^\circ\text{C}$		0.5	2		2	5	$\mu\text{V}/^\circ\text{C}$
Vv. Power Supply	$V_S = \pm 5\text{ V}$ to $\pm 18\text{ V}$			5			10	$\mu\text{V}/\text{V}$
Common-Mode Rejection Ratio	$V_S = \pm 15\text{ V}$, $V_{CM} = \pm 27\text{ V}$, $R_S = 0\ \Omega$	86			80			dB
Input Voltage Range ²		$2(-V_S) - 0.2$		$2(+V_S) - 3$	$2(-V_S) - 0.2$		$2(+V_S) - 3$	V
Impedance ³								
Differential			80			80		k Ω
Common Mode			40			40		k Ω
DYNAMIC PERFORMANCE								
Bandwidth			550			550		kHz
Slew Rate		0.9	1.1		0.9	1.1		V/ μs
Settling Time to 0.01%	10 V step on output, $C_L = 100\text{ pF}$			15			15	μs
Settling Time to 0.001%				16			16	μs
GAIN								
Gain Error			0.005	0.02		0.01	0.05	%
Gain Drift	$T_A = -40^\circ\text{C}$ to $+85^\circ\text{C}$			1			5	ppm/ $^\circ\text{C}$
Gain Nonlinearity	$V_{OUT} = 20\text{ V p-p}$			5			10	ppm
OUTPUT CHARACTERISTICS								
Output Voltage Swing ⁴	$V_S = \pm 15\text{ V}$, $T_A = -40^\circ\text{C}$ to $+85^\circ\text{C}$	$-V_S + 0.2$		$+V_S - 0.2$	$-V_S + 0.2$		$+V_S - 0.2$	V
Short-Circuit Current Limit			± 15			± 15		mA
Capacitive Load Drive			200			200		pF
NOISE ⁵								
Output Voltage Noise	$f = 0.1\text{ Hz}$ to 10 Hz		2			2		$\mu\text{V p-p}$
	$f = 1\text{ kHz}$		65	70		65	70	nV/ $\sqrt{\text{Hz}}$
POWER SUPPLY								
Supply Current ⁶				220			220	μA
vs. Temperature	$T_A = -40^\circ\text{C}$ to $+85^\circ\text{C}$			250			250	μA
Operating Voltage Range		± 2		± 18	± 2		± 18	V
TEMPERATURE RANGE								
Operating Range		-40		$+125$	-40		$+125$	$^\circ\text{C}$

¹ Includes input bias and offset current errors.

² The input voltage range may also be limited by absolute maximum input voltage or by the output swing. See the Input Voltage Range section in the Theory of Operation for details.

³ Internal resistors are trimmed to be ratio matched and have $\pm 20\%$ absolute accuracy.

⁴ Output voltage swing varies with supply voltage and temperature. See Figure 16 through Figure 19 for details.

⁵ Includes amplifier voltage and current noise, as well as noise from internal resistors.

⁶ Supply current varies with supply voltage and temperature. See Figure 20 and Figure 22 for details.

AD8276

$V_S = +2.7\text{ V}$ to $\pm 5\text{ V}$, $V_{REF} = \text{midsupply}$, $T_A = 25^\circ\text{C}$, $R_L = 10\text{ k}\Omega$ connected to midsupply, $G = 1$ difference amplifier configuration, unless otherwise noted.

Table 3.

Parameter	Conditions	Grade B			Grade A			Unit
		Min	Typ	Max	Min	Typ	Max	
INPUT CHARACTERISTICS								
System Offset ¹			150	200		100	500	μV
vs. Temperature	$T_A = -40^\circ\text{C}$ to $+85^\circ\text{C}$			200			500	μV
Average Temperature Coefficient	$T_A = -40^\circ\text{C}$ to $+85^\circ\text{C}$		0.5	2		2	5	$\mu\text{V}/^\circ\text{C}$
vs. Power Supply	$V_S = \pm 5\text{ V}$ to $\pm 18\text{ V}$			5			10	$\mu\text{V}/\text{V}$
Common-Mode Rejection Ratio	$V_S = 2.7\text{ V}$, $V_{CM} = 0\text{ V}$ to 2.4 V , $R_S = 0\ \Omega$	86			80			dB
	$V_S = \pm 5\text{ V}$, $V_{CM} = -10\text{ V}$ to $+7\text{ V}$, $R_S = 0\ \Omega$	86			80			dB
Input Voltage Range ²		$2(-V_S) - 0.2$		$2(+V_S) - 3$	$2(-V_S) - 0.2$		$2(+V_S) - 3$	V
Impedance ³								
Differential			80			80		k Ω
Common Mode			40			40		k Ω
DYNAMIC PERFORMANCE								
Bandwidth			450			450		kHz
Slew Rate			1.0			1.0		V/ μs
Settling Time to 0.01%	8 V step on output, $C_L = 100\text{ pF}$, $V_S = 10\text{ V}$		5			5		μs
GAIN								
Gain Error			0.005	0.02		0.01	0.05	%
Gain Drift	$T_A = -40^\circ\text{C}$ to $+85^\circ\text{C}$			1			5	ppm/ $^\circ\text{C}$
OUTPUT CHARACTERISTICS								
Output Swing ⁴	$T_A = -40^\circ\text{C}$ to $+85^\circ\text{C}$	$-V_S + 0.1$		$+V_S - 0.15$	$-V_S + 0.1$		$+V_S - 0.15$	V
Short-Circuit Current Limit			± 10			± 10		mA
Capacitive Load Drive			200			200		pF
NOISE⁵								
Output Voltage Noise	$f = 0.1\text{ Hz}$ to 10 Hz		2			2		$\mu\text{V p-p}$
	$f = 1\text{ kHz}$		65			65		nV/ $\sqrt{\text{Hz}}$
POWER SUPPLY								
Supply Current ⁶	$T_A = -40^\circ\text{C}$ to $+85^\circ\text{C}$			220			220	μA
Operating Voltage Range		2.5		36	2.5		36	V
TEMPERATURE RANGE								
Operating Range		-40		+125	-40		+125	$^\circ\text{C}$

¹ Includes input bias and offset current errors.

² The input voltage range may also be limited by absolute maximum input voltage or by the output swing. See the Input Voltage Range section in the Theory of Operation for details.

³ Internal resistors are trimmed to be ratio matched and have $\pm 20\%$ absolute accuracy.

⁴ Output voltage swing varies with supply voltage and temperature. See Figure 16 through Figure 19 for details.

⁵ Includes amplifier voltage and current noise, as well as noise from internal resistors.

⁶ Supply current varies with supply voltage and temperature. See Figure 21 and Figure 22 for details.

ABSOLUTE MAXIMUM RATINGS

Table 4.

Parameter	Rating
Supply Voltage	$\pm 18\text{ V}$
Maximum Voltage at Any Input Pin	$-V_S + 40\text{ V}$
Minimum Voltage at Any Input Pin	$+V_S - 40\text{ V}$
Storage Temperature Range	-65°C to $+150^\circ\text{C}$
Specified Temperature Range	-40°C to $+85^\circ\text{C}$
Package Glass Transition Temperature (T_G)	150°C

Stresses above those listed under Absolute Maximum Ratings may cause permanent damage to the device. This is a stress rating only; functional operation of the device at these or any other conditions above those indicated in the operational section of this specification is not implied. Exposure to absolute maximum rating conditions for extended periods may affect device reliability.

THERMAL RESISTANCE

The θ_{JA} values in Table 5 assume a 4-layer JEDEC standard board with zero airflow.

Table 5. Thermal Resistance

Package Type	θ_{JA}	Unit
8-Lead MSOP	135	$^\circ\text{C}/\text{W}$
8-Lead SOIC	121	$^\circ\text{C}/\text{W}$

MAXIMUM POWER DISSIPATION

The maximum safe power dissipation for the AD8276 is limited by the associated rise in junction temperature (T_J) on the die. At approximately 150°C , which is the glass transition temperature, the properties of the plastic change. Even temporarily exceeding this temperature limit may change the stresses that the package exerts on the die, permanently shifting the parametric performance of the amplifiers. Exceeding a temperature of 150°C for an extended period may result in a loss of functionality.

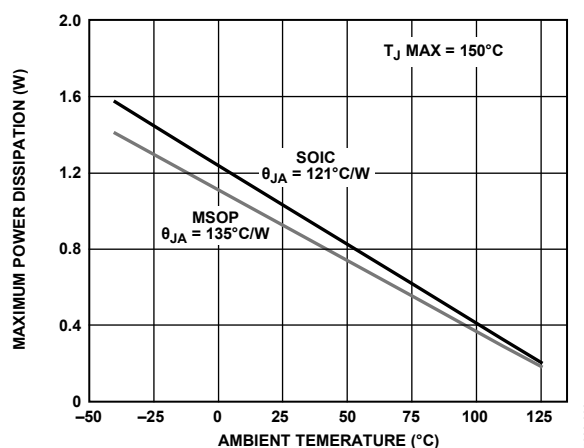

Figure 2. Maximum Power Dissipation vs. Ambient Temperature

SHORT-CIRCUIT CURRENT

The AD8276 has built-in, short-circuit protection that limits the output current (see Figure 23 for more information). While the short-circuit condition itself does not damage the part, the heat generated by the condition can cause the part to exceed its maximum junction temperature, with corresponding negative effects on reliability. Figure 2 and Figure 23, combined with knowledge of the part's supply voltages and ambient temperature, can be used to determine whether a short circuit will cause the part to exceed its maximum junction temperature.

ESD CAUTION



ESD (electrostatic discharge) sensitive device. Charged devices and circuit boards can discharge without detection. Although this product features patented or proprietary protection circuitry, damage may occur on devices subjected to high energy ESD. Therefore, proper ESD precautions should be taken to avoid performance degradation or loss of functionality.

AD8276

PIN CONFIGURATIONS AND FUNCTION DESCRIPTIONS

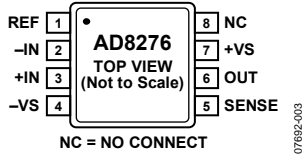

Figure 3. MSOP Pin Configuration

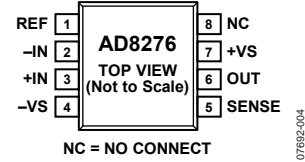

Figure 4. SOIC Pin Configuration

Table 6. Pin Function Descriptions

Pin No.	Mnemonic	Description
1	REF	Reference Voltage Input
2	-IN	Inverting Input
3	+IN	Noninverting Input
4	-VS	Negative Supply
5	SENSE	Sense Terminal
6	OUT	Output
7	+VS	Positive Supply
8	NC	No Connect

TYPICAL PERFORMANCE CHARACTERISTICS

$V_S = \pm 15\text{ V}$, $T_A = 25^\circ\text{C}$, $R_L = 10\text{ k}\Omega$ connected to ground, $G = 1$ difference amplifier configuration, unless otherwise noted.

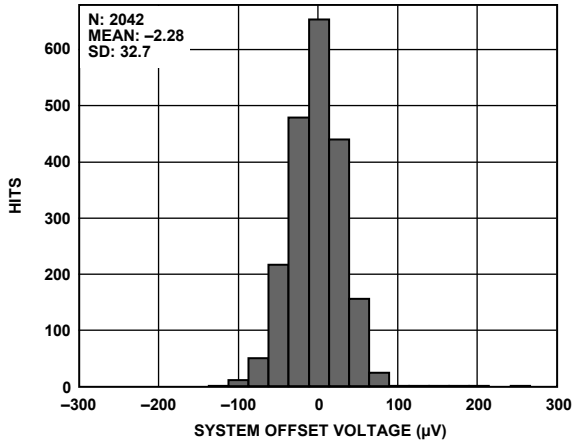

Figure 5. Distribution of Typical System Offset Voltage

07692-005

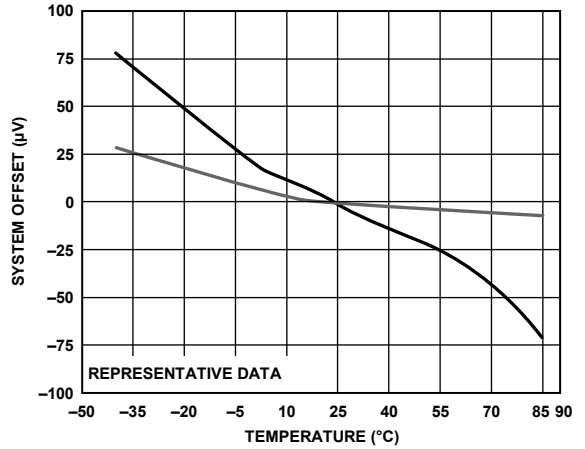

Figure 8. System Offset vs. Temperature, Normalized at 25°C

07692-008

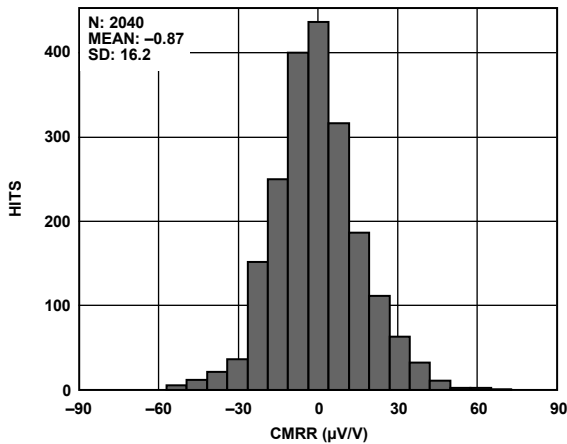

Figure 6. Distribution of Typical Common-Mode Rejection

07692-006

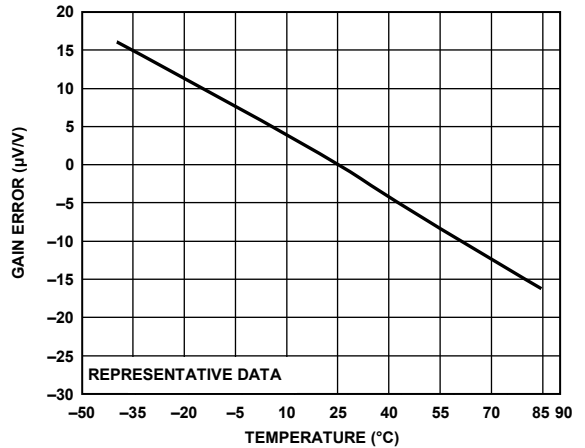

Figure 9. Gain Error vs. Temperature, Normalized at 25°C

07692-009

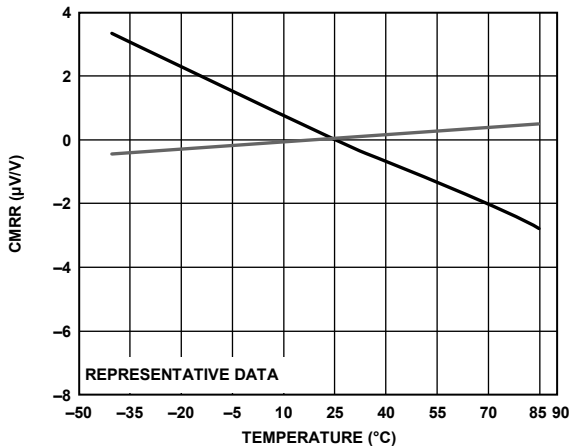

Figure 7. CMRR vs. Temperature, Normalized at 25°C

07692-007

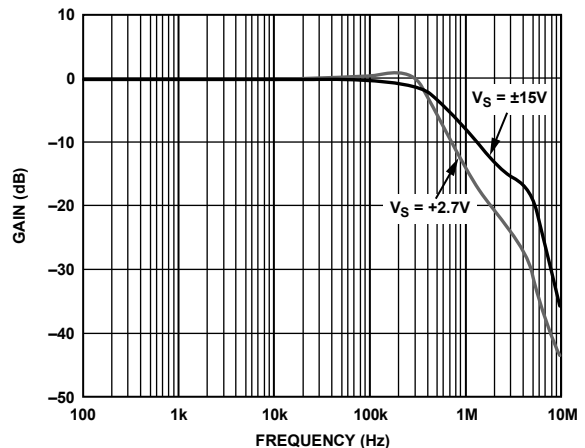

Figure 10. Gain vs. Frequency, $V_S = \pm 15\text{ V}$, $+2.7\text{ V}$

07692-010

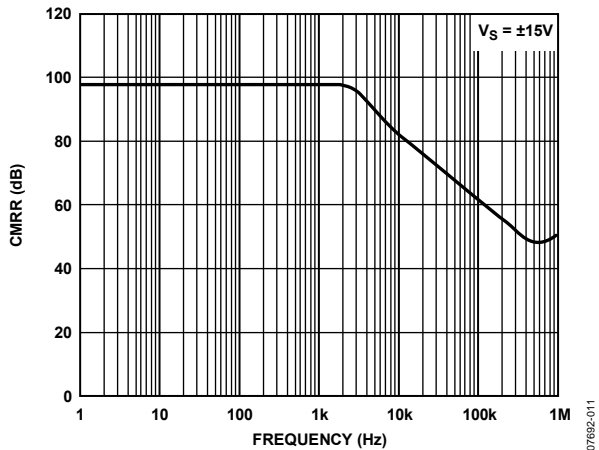

Figure 11. CMRR vs. Frequency

07692-011

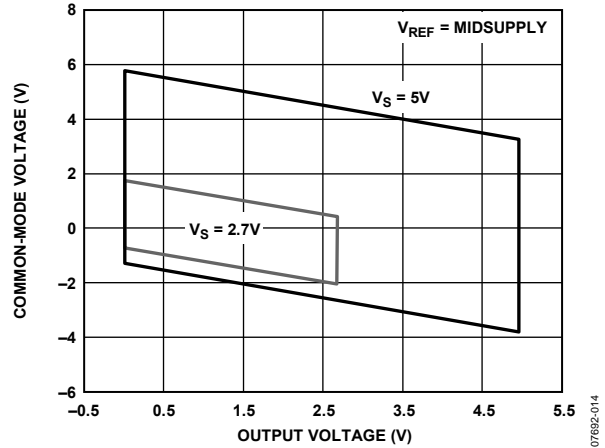

Figure 14. Input Common-Mode Voltage vs. Output Voltage, 5 V and 2.7 V Supplies, $V_{REF} = \text{Midsupply}$

07692-014

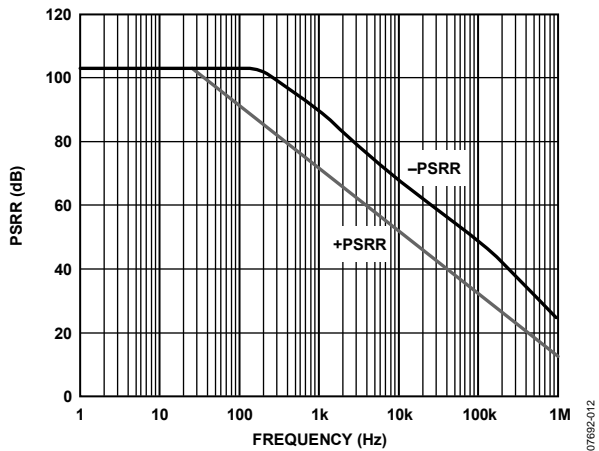

Figure 12. PSRR vs. Frequency

07692-012

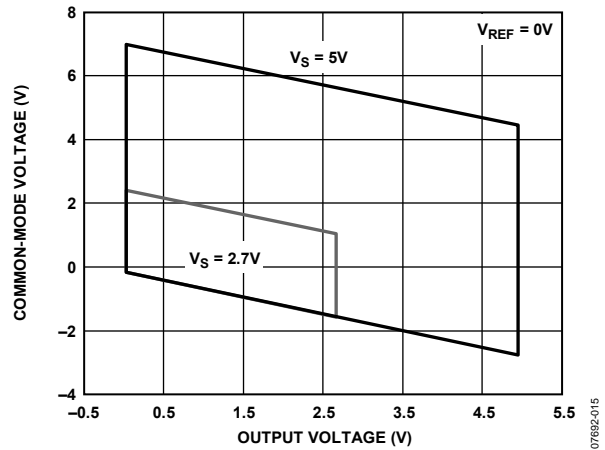

Figure 15. Input Common-Mode Voltage vs. Output Voltage, 5 V and 2.7 V Supplies, $V_{REF} = 0\text{ V}$

07692-015

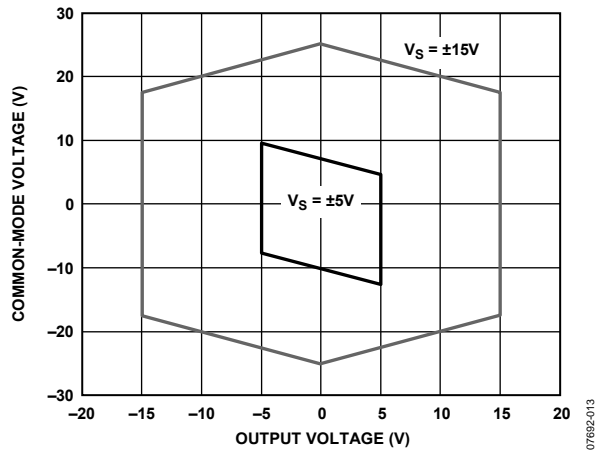

Figure 13. Input Common-Mode Voltage vs. Output Voltage, $\pm 15\text{ V}$ and $\pm 5\text{ V}$ Supplies

07692-013

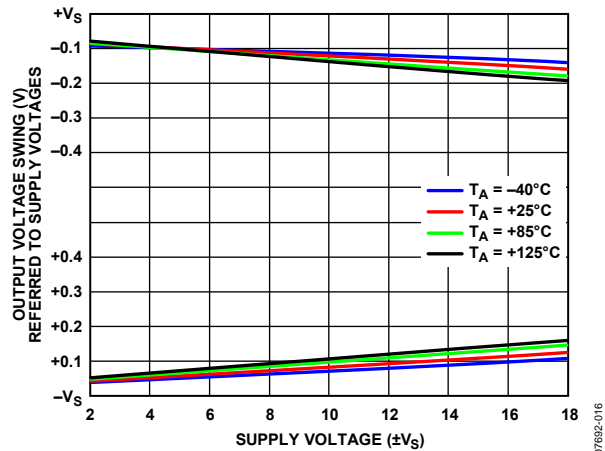

Figure 16. Output Voltage Swing vs. Supply Voltage and Temperature, $R_L = 10\text{ k}\Omega$

07692-016

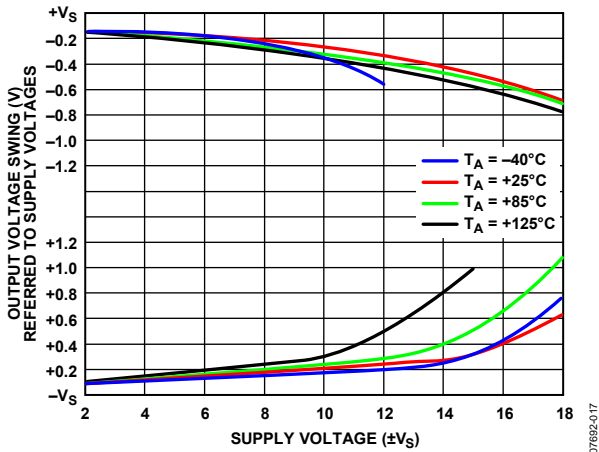

Figure 17. Output Voltage Swing vs. Supply Voltage and Temperature, $R_L = 2\text{ k}\Omega$

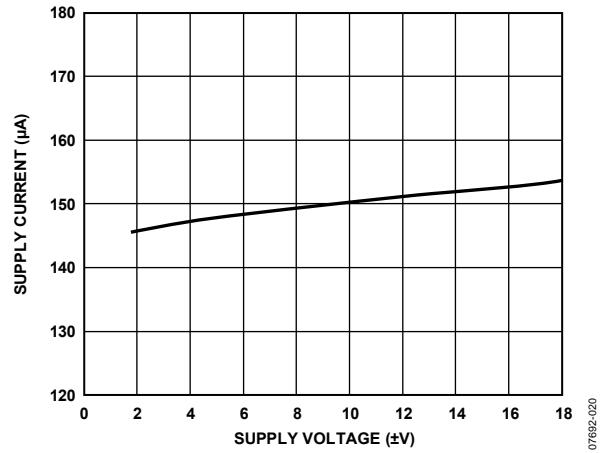

Figure 20. Supply Current vs. Dual Supply Voltage, $V_{IN} = 0\text{ V}$

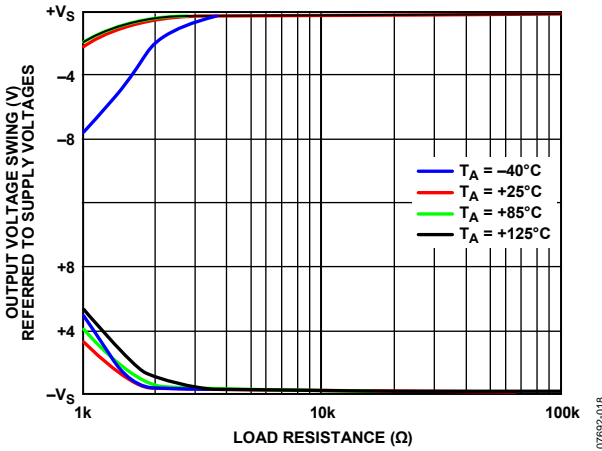

Figure 18. Output Voltage Swing vs. R_L and Temperature, $V_S = \pm 15\text{ V}$

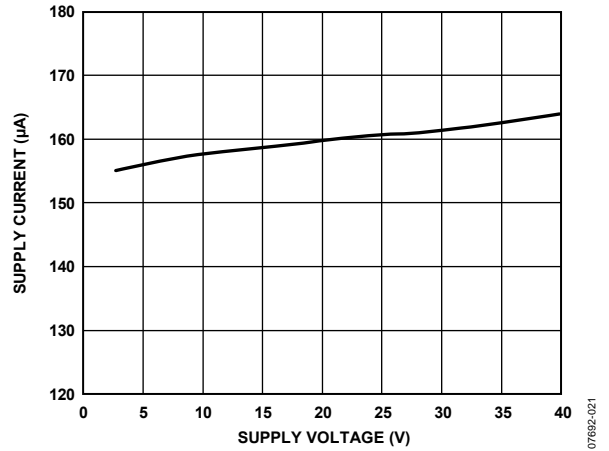

Figure 21. Supply Current vs. Single-Supply Voltage, $V_{IN} = 0\text{ V}$, $V_{REF} = 0\text{ V}$

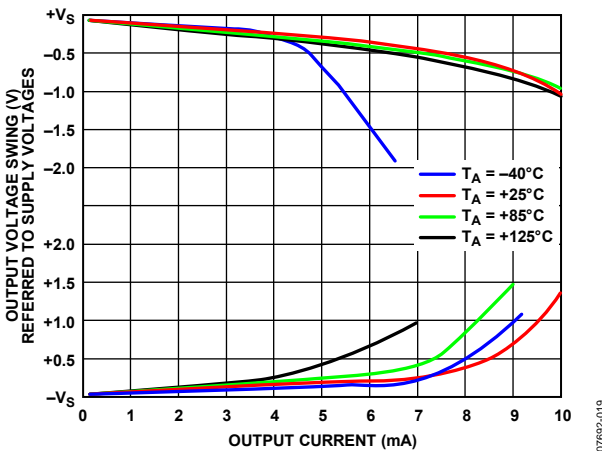

Figure 19. Output Voltage Swing vs. I_{OUT} and Temperature, $V_S = \pm 15\text{ V}$

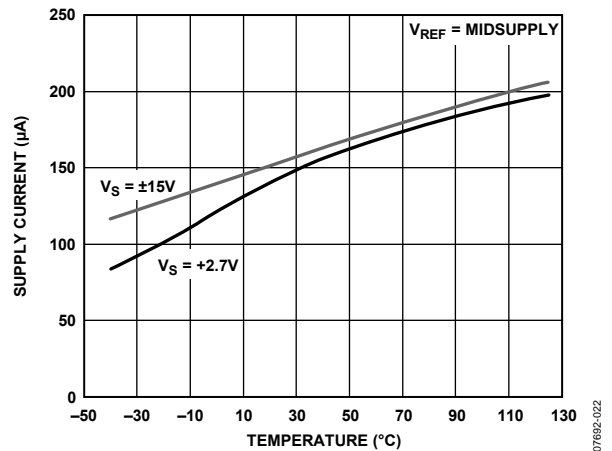

Figure 22. Supply Current vs. Temperature

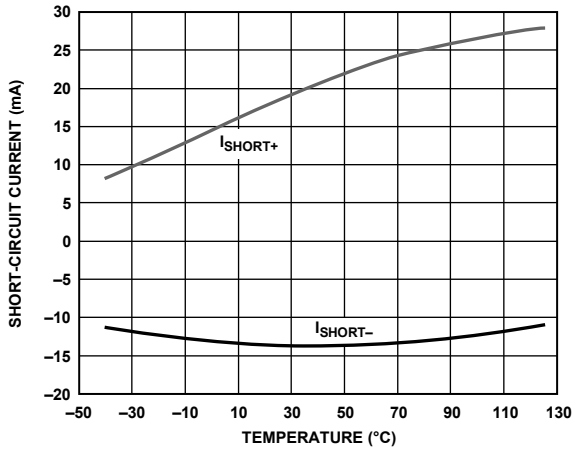

Figure 23. Short-Circuit Current vs. Temperature

07692-023

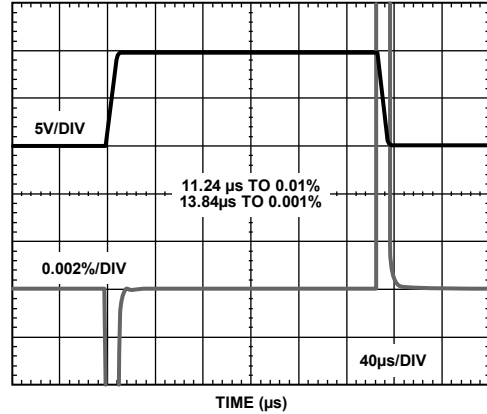

Figure 26. Large-Signal Pulse Response and Settling Time, 10 V Step, $V_S = \pm 15 V$

07692-026

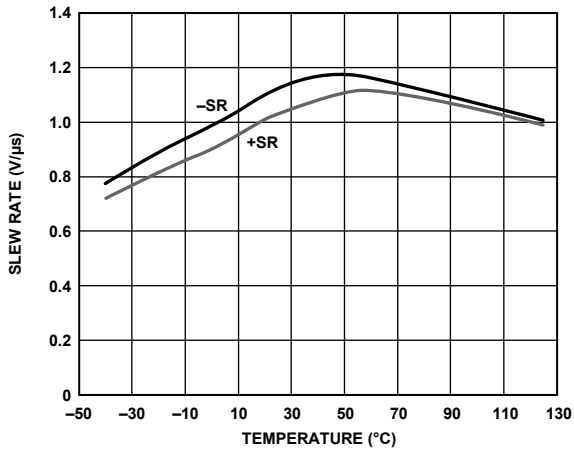

Figure 24. Slew Rate vs. Temperature, $V_{IN} = 20 V p-p$, 1 kHz

07692-024

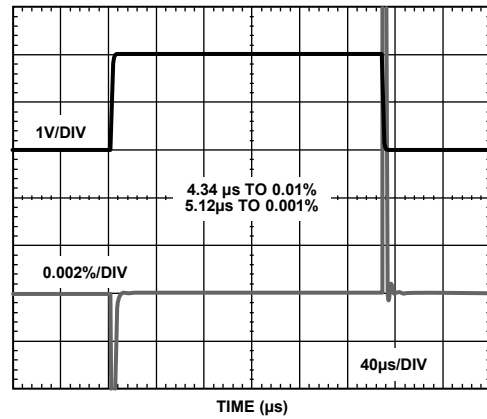

Figure 27. Large-Signal Pulse Response and Settling Time, 2 V Step, $V_S = 2.7 V$

07692-027

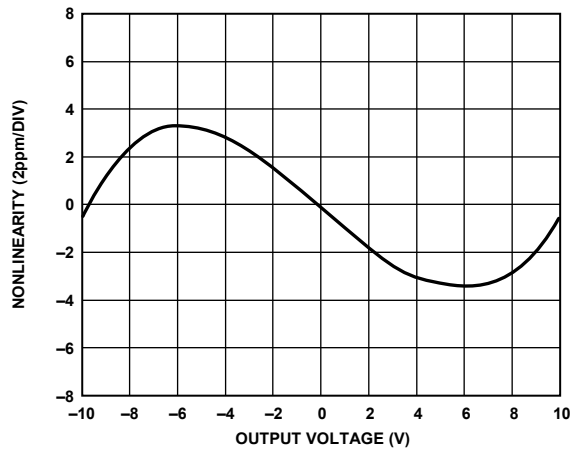

Figure 25. Gain Nonlinearity, $V_S = \pm 15 V$, $R_L \geq 2 k\Omega$

07692-025

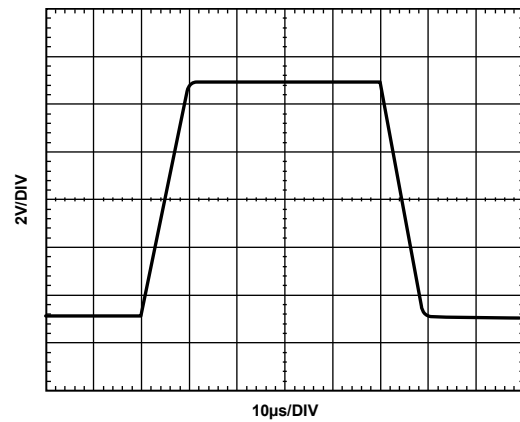

Figure 28. Large-Signal Step Response

07692-028

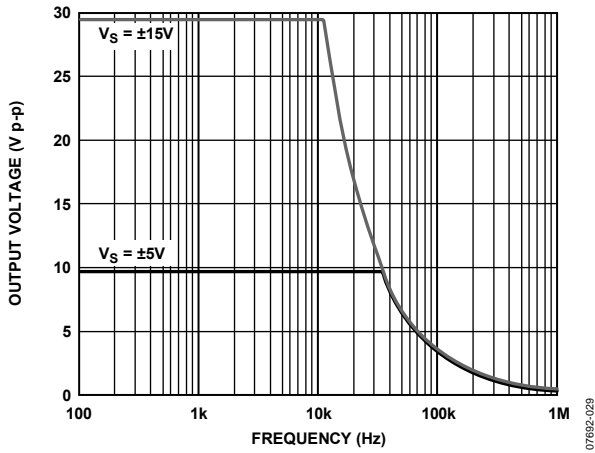

Figure 29. Maximum Output Voltage vs. Frequency, $V_S = \pm 15\text{ V}, \pm 5\text{ V}$

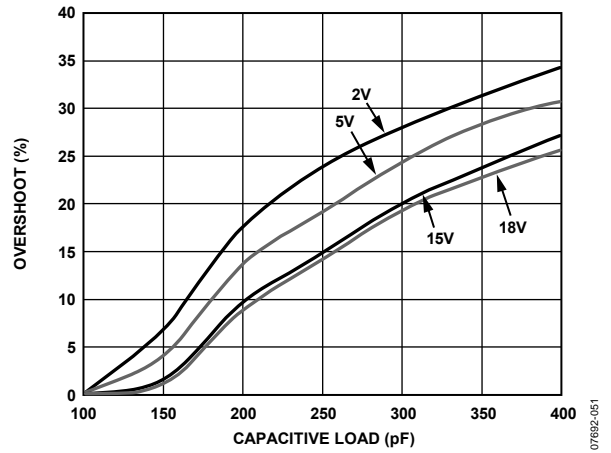

Figure 32. Small-Signal Overshoot vs. Capacitive Load, $R_L \geq 2\text{ k}\Omega$

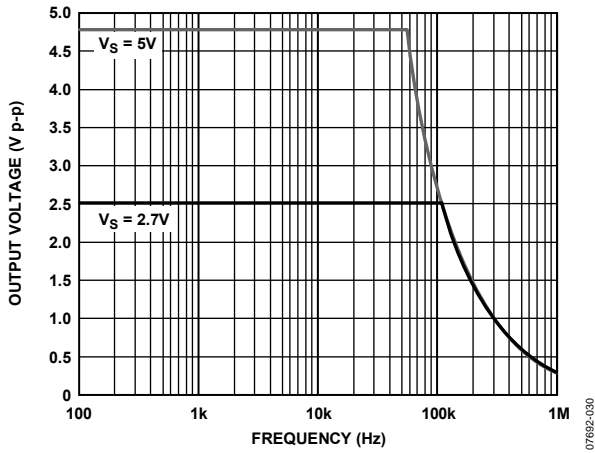

Figure 30. Maximum Output Voltage vs. Frequency, $V_S = 5\text{ V}, 2.7\text{ V}$

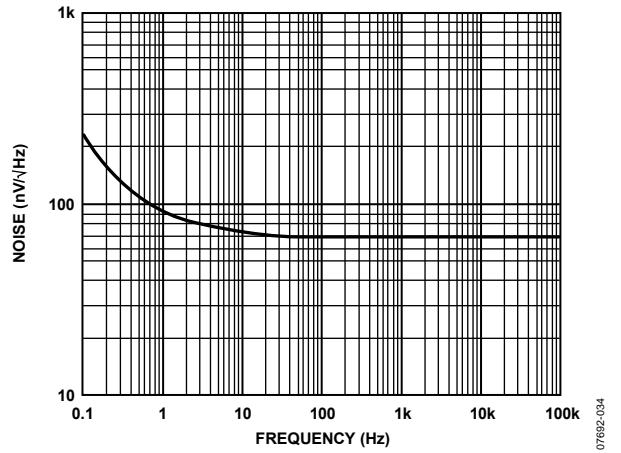

Figure 33. Voltage Noise Density vs. Frequency

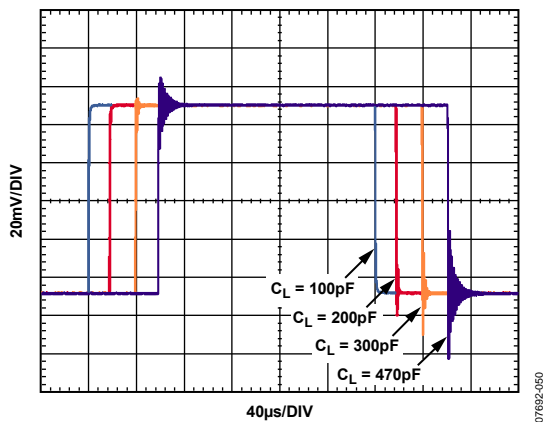

Figure 31. Small-Signal Step Response for Various Capacitive Loads

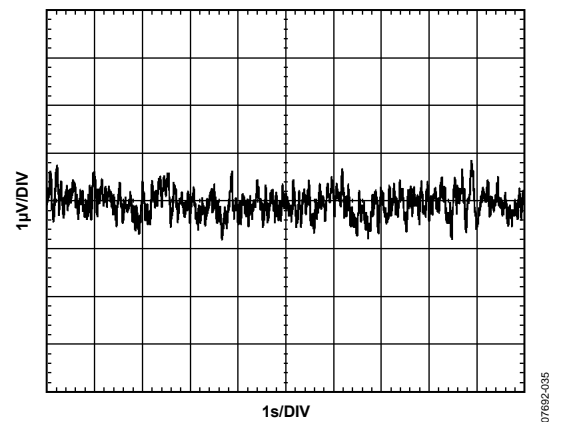

Figure 34. 0.1 Hz to 10 Hz Voltage Noise

THEORY OF OPERATION

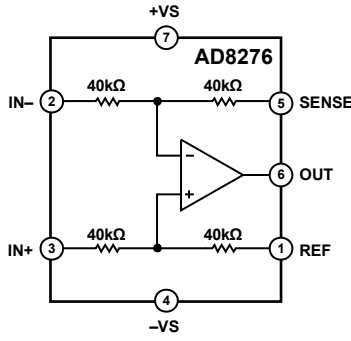

Figure 35. Functional Block Diagram

CIRCUIT INFORMATION

The AD8276 consists of a low power, low noise op amp and four laser-trimmed on-chip resistors. These resistors can be externally connected to make a variety of amplifier configurations, including difference, noninverting, and inverting configurations. Taking advantage of the integrated resistors of the AD8276 provides the designer with several benefits over a discrete design.

DC Performance

Much of the dc performance of op amp circuits depends on the accuracy of the surrounding resistors. This can be verified by a simple examination of the typical difference amplifier configuration, as shown in Figure 36. The output voltage is

$$V_{OUT} = \frac{R4}{R3} (V_{IN+} - V_{IN-})$$

as long as the following ratio of the resistors is tightly matched:

$$\frac{R2}{R1} = \frac{R4}{R3}$$

The resistors on the AD8276 are laid out to optimize their matching, and they are laser trimmed and tested for their matching accuracy. Because of this trimming and testing, the AD8276 can guarantee high accuracy and consistency for specifications such as gain drift, common-mode rejection, and gain error, even over a wide temperature range.

AC Performance

The feature size is much smaller in an IC than on a PCB, so the corresponding parasitics are also smaller, which helps the ac performance of the AD8276. For example, the positive and negative input terminals of the AD8276 op amp are not pinned out intentionally. By not connecting these nodes to the traces on the PCB, the capacitance remains low, resulting in both improved loop stability and common-mode rejection over frequency.

DRIVING THE AD8276

With all configurations presenting at least several kilohms ($k\Omega$) of input resistance, the AD8276 is easy to drive. Drive the AD8276 with a low impedance source: for example, another amplifier. The gain accuracy and common-mode rejection of the AD8276 depend on the matching of its resistors. Even source resistance of a few ohms can have a substantial effect on these specifications.

POWER SUPPLIES

Use a stable dc voltage to power the AD8276. Noise on the supply pins can adversely affect performance. Place a bypass capacitor of 0.1 μF between each supply pin and ground, as close as possible to each supply pin. Use a tantalum capacitor of 10 μF between each supply and ground. It can be farther away from the supply pins and, typically, it can be shared by other precision integrated circuits.

The AD8276 is specified at $\pm 15\text{ V}$, but it can be used with unbalanced supplies, as well. For example, $-V_S = 0\text{ V}$, $+V_S = 20\text{ V}$. The difference between the two supplies must be kept below 36 V.

INPUT VOLTAGE RANGE

The AD8276 is able to measure input voltages beyond the rails because the internal resistors divide down the voltage before it reaches the internal op amp. Figure 36 shows an example of how the voltage division works in a difference amplifier configuration. In order for the AD8276 to measure correctly, the input voltages at the input nodes of the internal op amp must stay within 1.5 V of the positive supply rail and can exceed the negative supply rail by 0.1 V.

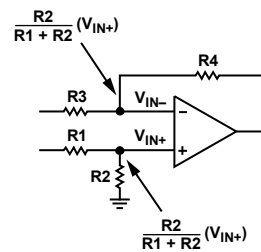

Figure 36. Voltage Division in the Difference Amplifier Configuration

For best long-term reliability of the part, voltages at any of the part's inputs (Pin 1, Pin 2, Pin 3, or Pin 5) should stay within $+V_S - 40\text{ V}$ to $-V_S + 40\text{ V}$. For example, on $\pm 10\text{ V}$ supplies, input voltages should not exceed $\pm 30\text{ V}$.

APPLICATIONS INFORMATION CONFIGURATIONS

The AD8276 can be configured in several ways; see Figure 38 to Figure 42. All of these configurations have excellent gain accuracy and gain drift because they rely on the internal matched resistors. Note that Figure 39 shows the AD8276 as a difference amplifier with a midsupply reference voltage at the noninverting input. This allows the AD8276 to be used as a level shifter.

As with the other inputs, the reference must be driven with a low impedance source to maintain the internal resistor ratio. An example using the low power, low noise OP1177 as a reference is shown in Figure 37.

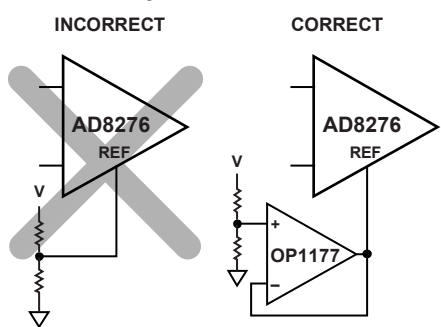

Figure 37. Driving the Reference Pin

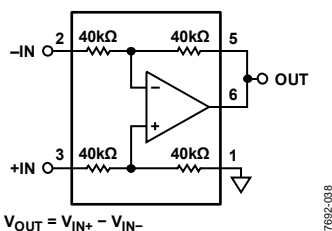

Figure 38. Difference Amplifier, Gain = 1

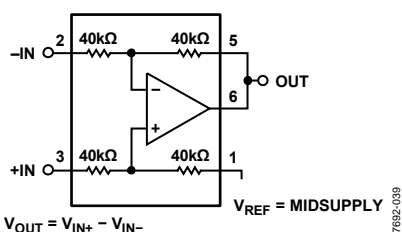

Figure 39. Difference Amplifier, Gain = 1, Referenced to Midsupply

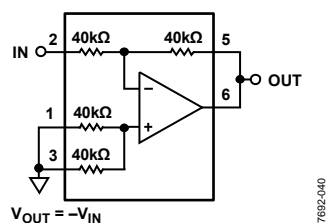

Figure 40. Inverting Amplifier, Gain = -1

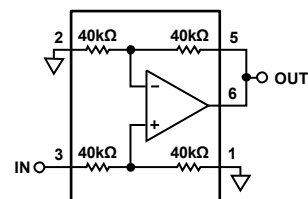

Figure 41. Noninverting Amplifier, Gain = 1

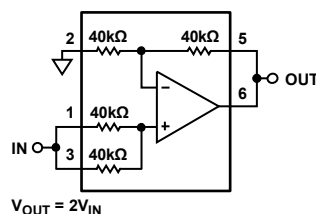

Figure 42. Noninverting Amplifier, Gain = 2

DIFFERENTIAL OUTPUT

Certain systems require a differential signal for better performance, such as the inputs to differential analog-to-digital converters. Figure 43 shows how the AD8276 can be used to convert a single-ended output from an AD8226 instrumentation amplifier into a differential signal. The AD8276 internal matched resistors at the inverting input maximize gain accuracy while generating a differential signal. The resistors at the noninverting input can be used as a divider to set and track the common-mode voltage accurately to midsupply, especially when running on a single supply or in an environment where the supply fluctuates. The resistors at the noninverting input can also be shorted and set to any appropriate bias voltage. Note that the $V_{BIAS} = V_{CM}$ node indicated in Figure 43 is internal to the AD8276 because it is not pinned out.

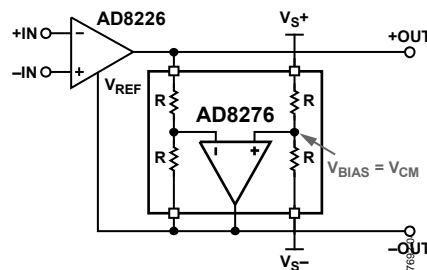

Figure 43. Differential Output With Supply Tracking on Common-Mode Voltage Reference

The differential output voltage and common-mode voltage of the AD8226 is shown in the following equations:

$$V_{DIFF_OUT} = V_{+OUT} - V_{-OUT} = Gain_{AD8226} \times (V_{+IN} - V_{-IN})$$

$$V_{CM} = (V_{S+} - V_{S-})/2 = V_{BIAS}$$

Refer to the AD8226 data sheet for additional information.

AD8276

INSTRUMENTATION AMPLIFIER

The AD8276 can be used as a building block for a low power, low cost instrumentation amplifier. An instrumentation amplifier provides high impedance inputs and delivers high common-mode rejection. Combining the AD8276 with an Analog Devices low power amplifier (examples provided in Table 7) creates a precise, power efficient voltage measurement solution suitable for power critical systems.

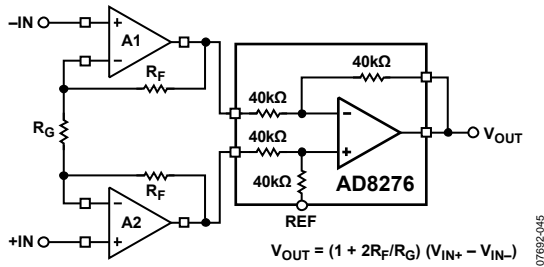

Figure 44. Low Power Precision Instrumentation Amplifier

Table 7. Low Power Op Amps

Op Amp (A1, A2)	Features
AD8506	Dual micropower op amp
AD8607	Precision dual micropower op amp
AD8617	Low cost CMOS micropower op amp
AD8667	Dual precision CMOS micropower op amp

It is preferable to use dual op amps for the high impedance inputs, because they have better matched performance and track each other over temperature. The AD8276 difference amplifier cancels out common-mode errors from the input op amps, if they track each other. The differential gain accuracy of the in-amp is proportional to how well the input feedback resistors (R_F) match each other. The CMRR of the in-amp increases as the differential gain is increased ($1 + 2R_F/R_G$), but a higher gain also reduces the common-mode voltage range. Refer to [A Designer's Guide to Instrumentation Amplifiers](#) for more design ideas and considerations.

CURRENT SOURCE

The AD8276 difference amplifier can be implemented as part of a voltage-to-current converter or a precision constant current source as shown in Figure 45. The internal resistors are tightly matched to minimize error and temperature drift. If the external resistors R_1 and R_2 are not well-matched, they will be a significant source of error in the system, so precision resistors are recommended to maintain performance. The [ADR821](#) provides a precision voltage reference and integrated op amp that also reduces error in the signal chain.

The AD8276 has rail-to-rail output capability, which allows higher current outputs.

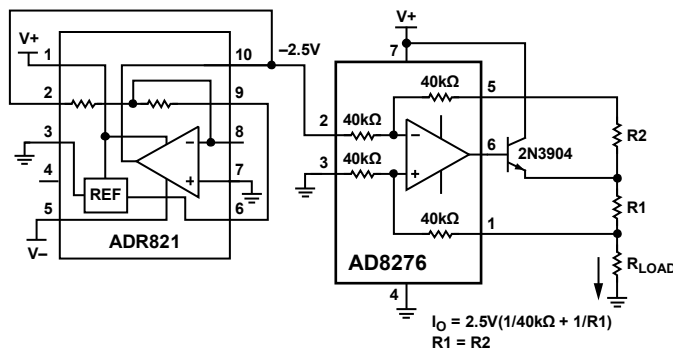
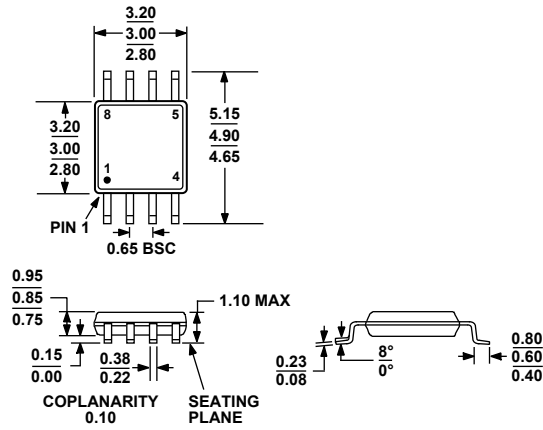

Figure 45. Constant Current Source

OUTLINE DIMENSIONS



COMPLIANT TO JEDEC STANDARDS MO-187-AA

Figure 46. 8-Lead Mini Small Outline Package [MSOP] (RM-8)

Dimensions shown in millimeters

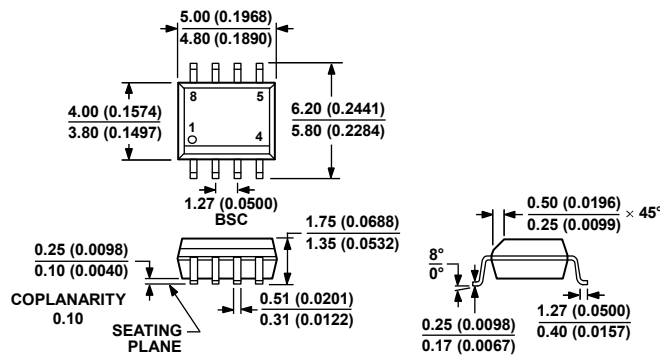

COMPLIANT TO JEDEC STANDARDS MS-012-AA

CONTROLLING DIMENSIONS ARE IN MILLIMETERS; INCH DIMENSIONS (IN PARENTHESES) ARE ROUNDED-OFF MILLIMETER EQUIVALENTS FOR REFERENCE ONLY AND ARE NOT APPROPRIATE FOR USE IN DESIGN.

Figure 47. 8-Lead Standard Small Outline Package [SOIC_N] Narrow Body (R-8)

Dimensions shown in millimeters and (inches)

012407-A

AD8276

ORDERING GUIDE

Model	Temperature Range	Package Description	Package Option	Branding
AD8276ARZ ¹	-40°C to +85°C	8-Lead SOIC_N	R-8	
AD8276ARZ-R7 ¹	-40°C to +85°C	8-Lead SOIC_N, 7" Tape and Reel	R-8	
AD8276ARZ-RL ¹	-40°C to +85°C	8-Lead SOIC_N, 13" Tape and Reel	R-8	
AD8276BRZ ¹	-40°C to +85°C	8-Lead SOIC_N	R-8	
AD8276BRZ-R7 ¹	-40°C to +85°C	8-Lead SOIC_N, 7" Tape and Reel	R-8	
AD8276BRZ-RL ¹	-40°C to +85°C	8-Lead SOIC_N, 13" Tape and Reel	R-8	
AD8276ARMZ ¹	-40°C to +85°C	8-Lead MSOP	RM-8	H1P
AD8276ARMZ-R7 ¹	-40°C to +85°C	8-Lead MSOP, 7" Tape and Reel	RM-8	H1P
AD8276ARMZ-RL ¹	-40°C to +85°C	8-Lead MSOP, 13" Tape and Reel	RM-8	H1P
AD8276BRMZ ¹	-40°C to +85°C	8-Lead MSOP	RM-8	H1Q
AD8276BRMZ-R7 ¹	-40°C to +85°C	8-Lead MSOP, 7" Tape and Reel	RM-8	H1Q
AD8276BRMZ-RL ¹	-40°C to +85°C	8-Lead MSOP, 13" Tape and Reel	RM-8	H1Q

¹ Z = RoHS Compliant Part.